

---

Please read this manual before using the machine.  
Please keep this manual within easy reach for quick reference.

---

BAS-761

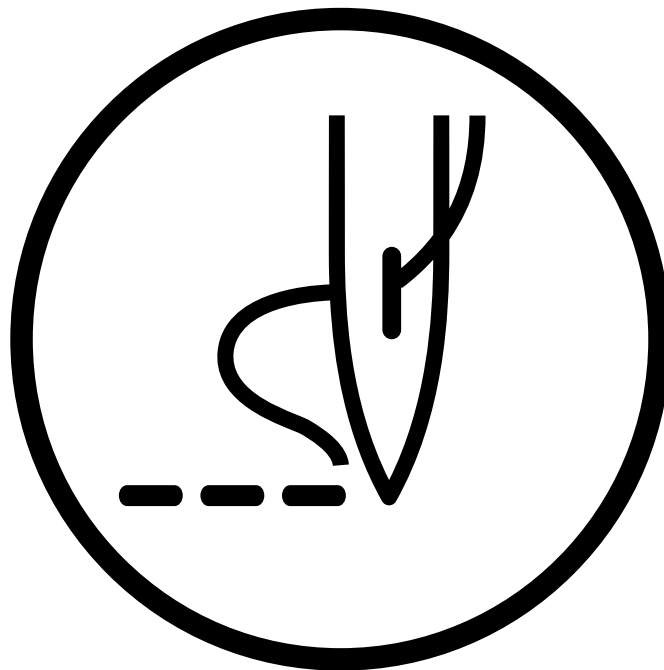

Thank you very much for purchasing the Brother Industrial Sewing Machine.

Please read this "Programmer Instruction Manual" and the separate volume "Automatic Pocket Setter Instruction Manual" carefully before using the machine.













Operation of this industrial sewing machine is usually carried out in front of moving parts such as the needle and the needle thread take-up. These parts may cause personal injury. Please follow the operational and safety instructions by the experts/instructors and use this machine correctly.









# Contents

## Chapter 1 Initial Setup

Connection .....	6
Handling the programmer .....	7
After use .....	7
Turning power ON/OFF .....	8
Turning power ON .....	8
Turning power OFF .....	9
Handling of floppy disk .....	10
Protecting data in floppy disks .....	11
Setting a Floppy Disk to the Floppy Disk Drive .....	11
Contents .....	12
Notes for programming .....	13

## Chapter 2 Programming with Help Function

Please read before programming .....	16
Panel description and usage .....	16
Display screen .....	17
Programming flowchart .....	18
Description of icons .....	20
 Programming .....	20
 Displaying a pattern image .....	20
 Checking the program setting and setting attribute .....	20
 Editing data .....	21
 Deleting data .....	21
Programming example .....	22
Programming for each stitch .....	22
Lines .....	24
Curve .....	26
Double stitch .....	29
Feed .....	31
Needle racking .....	34
Example of modified program .....	35
Resizing pattern .....	35
Changing partially .....	37
Deleting the first stitch .....	40
Changing the first stitch position .....	42
Adding sewing point before the first stitch .....	45
Adding shunting point before the first stitch .....	48
Moving the shunting point .....	51
Deleting the shunting point .....	53
Moving the entire pattern in parallel .....	55
Deleting a part of the program during programming .....	57
 Programming .....	58
 Creating a line .....	58
 Creating tacking data .....	58
 Creating a curve .....	59
 Carrying out double stitch .....	60
 Creating needle drop data .....	62
 Creating feed data .....	62

	Editing the current data .....	63
	Ending programming .....	65
	Displaying the data image during programming .....	66
	Checking the program setting and setting attribute .....	66
	Deleting a part of data .....	67
	Displaying a pattern image .....	68
	Checking the program setting and setting attribute .....	69
	Checking each stitch .....	70
	Checking a series of stitches automatically .....	70
	Editing program .....	72
	Deleting data .....	76

### Chapter 3 Programming with Command Function





	Please read before programming .....	78
	Panel description and usage .....	78
	Display screen .....	79
	Programming flowchart .....	79
	Description of commands .....	81
	Moving needle point .....	81
	Deleting data .....	81
	Ending programming .....	81
	Creating program .....	81
	Editing data .....	82
	Setting attribute .....	82
	Other operations .....	83
	Programming example .....	84
	Programming for each stitch .....	84
	Lines .....	85
	Curve .....	86
	Double stitch .....	88
	Feed .....	89
	Needle racking .....	91
	Example of modified program .....	92
	Resizing pattern .....	92
	Changing partially .....	93
	Deleting the first stitch .....	95
	Changing the first stitch position .....	96
	Adding sewing point before the first stitch .....	97
	Adding shunting point before the first stitch .....	99
	Moving the shunting point .....	101
	Deleting the shunting point .....	102
	Moving the entire pattern in parallel .....	103
	Deleting a part of the program during programming .....	104
	Programming .....	105
	Creating a line .....	105
	Creating a curve .....	106
	Creating double stitch .....	107
	Creating feed data .....	108
	Creating tacking data .....	109
	Ending programming .....	110
	Checking the program setting and setting attribute .....	111
	Checking attributes .....	112
	Setting needle tacking in a unit of one stitch .....	113
	Setting two step tension output .....	113
	Setting the option output .....	114

Setting two row switch .....	114
Low-speed sewing .....	115
Editing data .....	116
Changing stitch length of the program .....	116
Offset .....	117
Rotating a pattern clockwise (counterclockwise) .....	118
Resizing .....	119
Moving in parallel .....	120
Displaying image .....	122
Deleting a data .....	123
Deleting a part of data .....	123
Deleting program data .....	123

---

#### Chapter 4 Reading / Writing Data

---

 Reading data .....	126
Using the operation panel of the main body .....	128
 Writing data .....	129
Using the operation panel of the main body .....	131
 Deleting data in a floppy disk .....	132
 Formatting a floppy disk .....	134

---

#### Chapter 5 Practical Programming Examples

---

Programming examples .....	136
Example 1 (Help function) .....	137
Programming procedure .....	137
Operating procedure .....	138
Example 1 (Command function) .....	141
Programming procedure .....	141
Operating procedure .....	142
Example 2 (Help function) .....	144
Programming procedure .....	144
Operating procedure .....	145
Example 2 (Command function) .....	150
Programming procedure .....	150
Operating procedure .....	151

# Chapter 1

## Initial Setup

# Connection

---

Connection of the programmer cable to the machine is described here.

Check that the machine power is OFF before connecting the cable.

1. Connect the cable to the connector on the right side of the floppy disk drive.

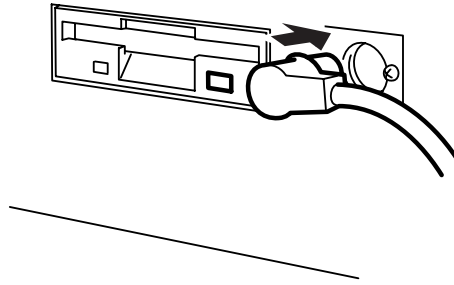

# Handling the programmer

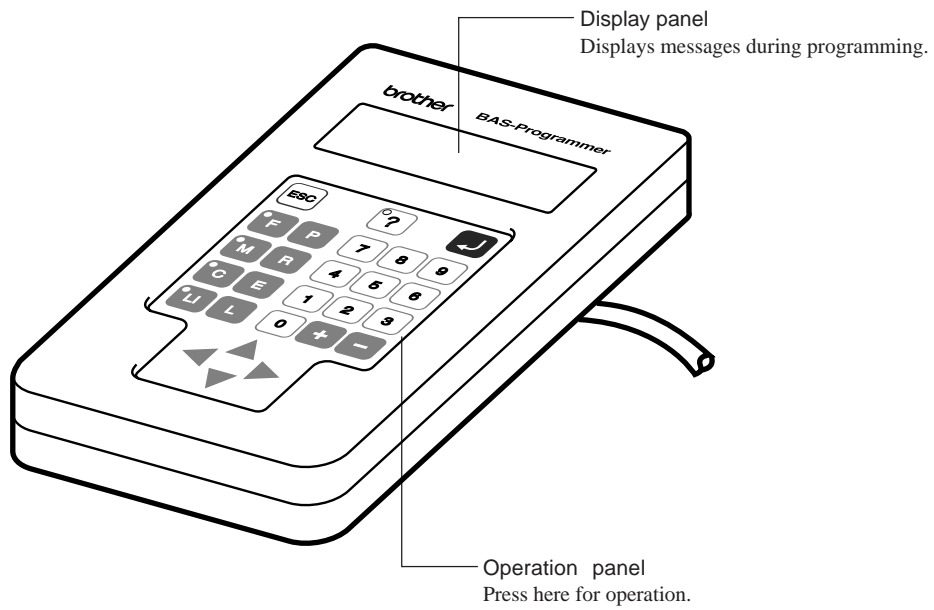

## After use

Wind the cable for storage as shown in the figure.

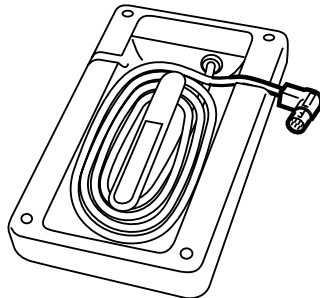



# Turning power ON/OFF

## Turning power ON

1. Switch ON the machine.

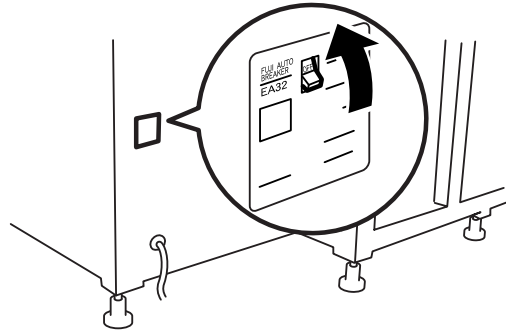

2. Press the reset switch of the folding machine and conduct positioning.

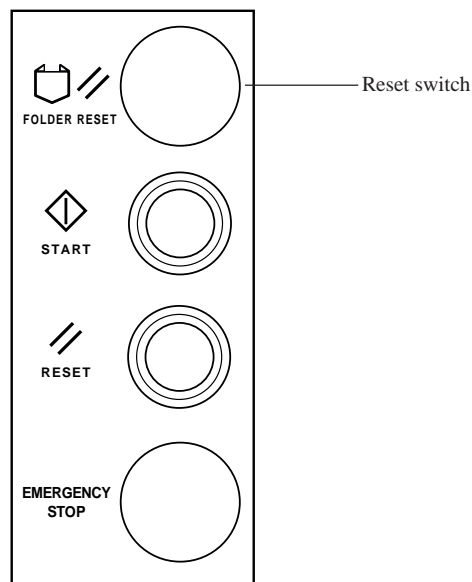

3. Set the pattern if it is prepared.  
Fix the pattern sheet with adhesive tape on the feed plate to prevent displacement.  
Put cloth below the work clamp if there is no pattern.
4. Press **P** on the programmer.  
The work clamp comes down.

## Turning power OFF

1. Write the programmer data into a floppy disk.  
Refer to "Writing data" (page 129.).  
If the data is not need to be saved, delete it.  
Refer to "Deleting program data" (page 123.).
2. Press **P** on the programmer.  
The panel turns off.
3. Remove the pattern sheet.
4. Switch OFF the machine.

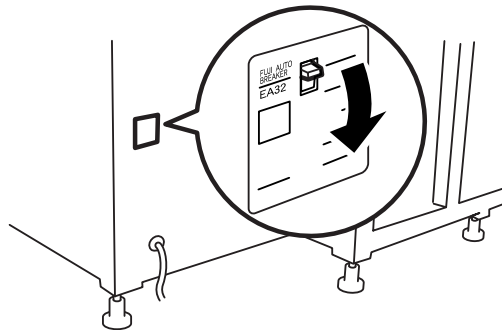

# Handling of floppy disk

Do not force open the shutter for direct contact with the magnetic area.

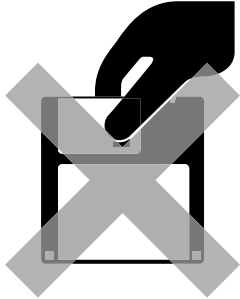

Do not bring disks near magnetic matters such as magnetic screwdriver or the back side of the programmer.

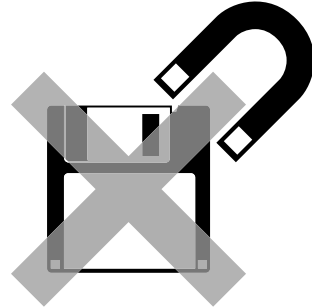

Do not store floppy disks in an extremely high or low ambient temperature.

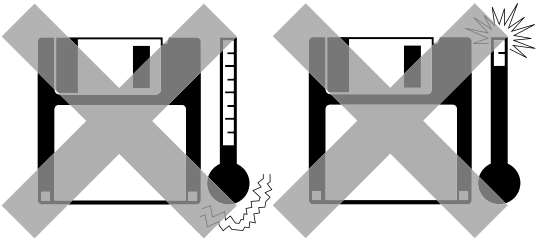

Do not use floppy disks under high humidity.

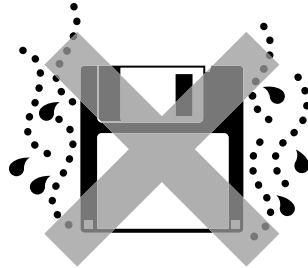

Do not use or store floppy disks in a dusty place.

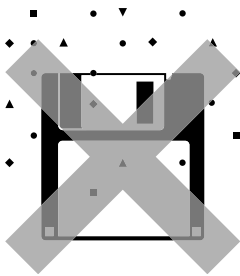

Do not store floppy disks under direct sunlight.

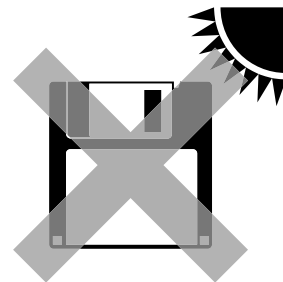

Do not bend the disk. Do not put things on the disk.

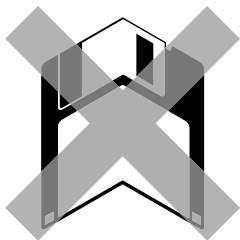

Avoid contact with solvent or drink.

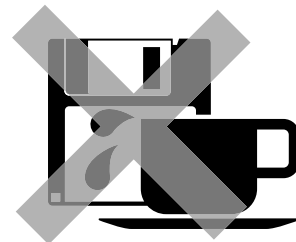

Do not remove the disk out of the drive during the access lamp is lit.

## Protecting data in floppy disks

Write-protection is available for a floppy disk to prevent undesired data deletion.

A write-protected disk is read-only. It is recommended to provide write-protection for disks which contain important data.

To do so, slide the write-protect notch to open the slot as shown below.

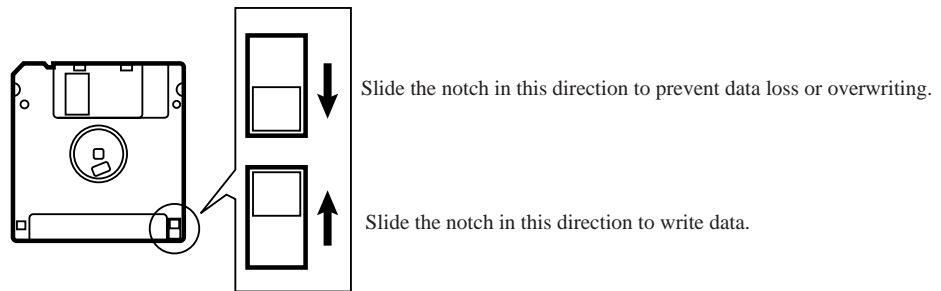

## Setting a Floppy Disk to the Floppy Disk Drive

Insert a floppy disk straight into the slot. The label side of the disk must face the front.

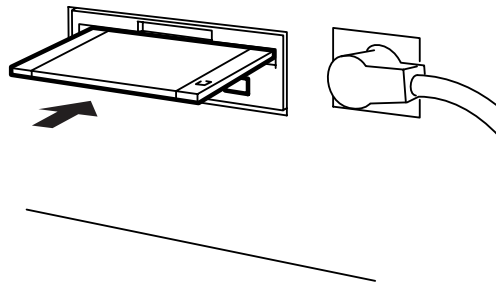

Press the eject switch to remove the disk out of the drive.

Do not press the eject switch during the access lamp is lit. This may lead to data corruption.

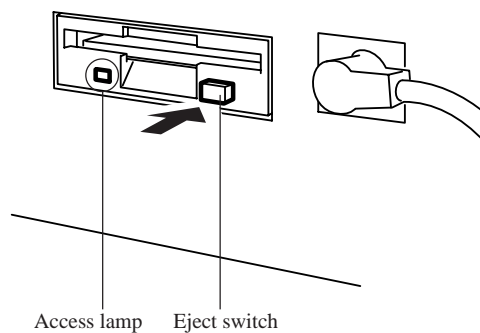

# Contents

---

This manual consists of the following chapters.

- Chapter 1    Preparations of operation  
Describes the basic precautions.
  
- Chapter 2    Programming with Help Function  
Describes the procedure to create programs using icons.  
It is recommended for persons  
    who are used to icon input.  
    who use this machine for the first time.  
    who sometimes create programs.
  
- Chapter 3    Programming with Command Function  
Describes the procedure to create programs using command functions.  
It is recommended for persons  
    who is specially responsible for program creation.  
    who have created programs for BAS-760 series.
  
- Chapter 4    Reading/Writing Data  
Describes the procedure to read from/write into floppy disks.
  
- Chapter 5    Practical programming examples  
Two examples of frequently created programs are described.

# Notes for programming

## Pattern sheet

Use thin plotting paper or prepare copies of pattern sheet.

The pattern sheet is designed in the original scale.

## Stitch length

Setting range between 0.3 and 6.0 mm is available.

As for the needle tacking data, values 0.1 to 1.0 mm are available.

## Stitch count

Maximum available count is 1,000.

## Selectable program numbers

Selectable program numbers vary depending on the clamps used when writing data.

When using a retractable clamp	00 ~ 31
When using other clamps	32 ~ 63

## Attributes of data when reading the data of BAS760

Attributes of data are as follows when reading the data of BAS760.

Needle tacking	Reflected
Two step tension	Reflected
Two row switch	Reflected(*)
Slow conversion	Ignored

(\*) Two step switch data is reflected in the normal position when reading the data complying with the specifications for BAS760 retractable clamp.

As for other clamps, slow conversion instructions to 2500 rpm or 3000 rpm are reflected as the two row switch data. Turn the setting of two row switch to off.

## Available types of floppy disk

Data type	Stitch count for memory	Data resolution	Disk	Format	Read	Write
BAS761 Data	1000 stitches/pattern	0.05 mm/pulse	2HD	DOS/V 1.44 MB	Available	Available
BAS760 Data	1000 stitches/pattern	0.1 mm/pulse	2DD	Formatted automatically.	Available	Not available

### Location to input the end code

Input the end code in the shaded area in the drawing because there is an air cylinder in the center when using the retractable clamp. Inputting the code in other locations will damage the machine because the top part and the cylinder come into contact with each other.

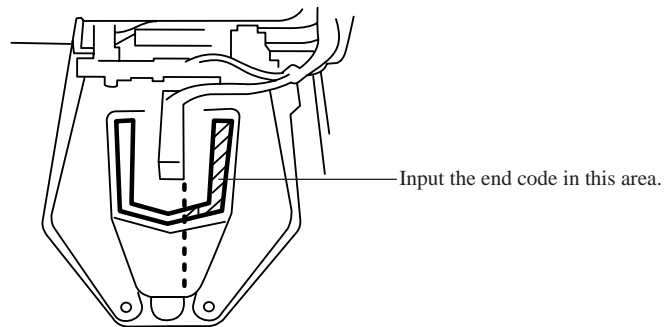

### Inputting numerical values

Input numerical values such as commands or the number of stitch from the programming instrument so that the numerical values become 3 digits. The values can be input again before pressing .

# Chapter 2

## Programming with Help Function



# Please read before programming

When the lamp on the button  is lit, small pictures appear on the display. These pictures represent different functions. They are called 'icons'. This chapter describes the method of programming with icons.

## Panel description and usage

The following panel keys are used in Help mode.

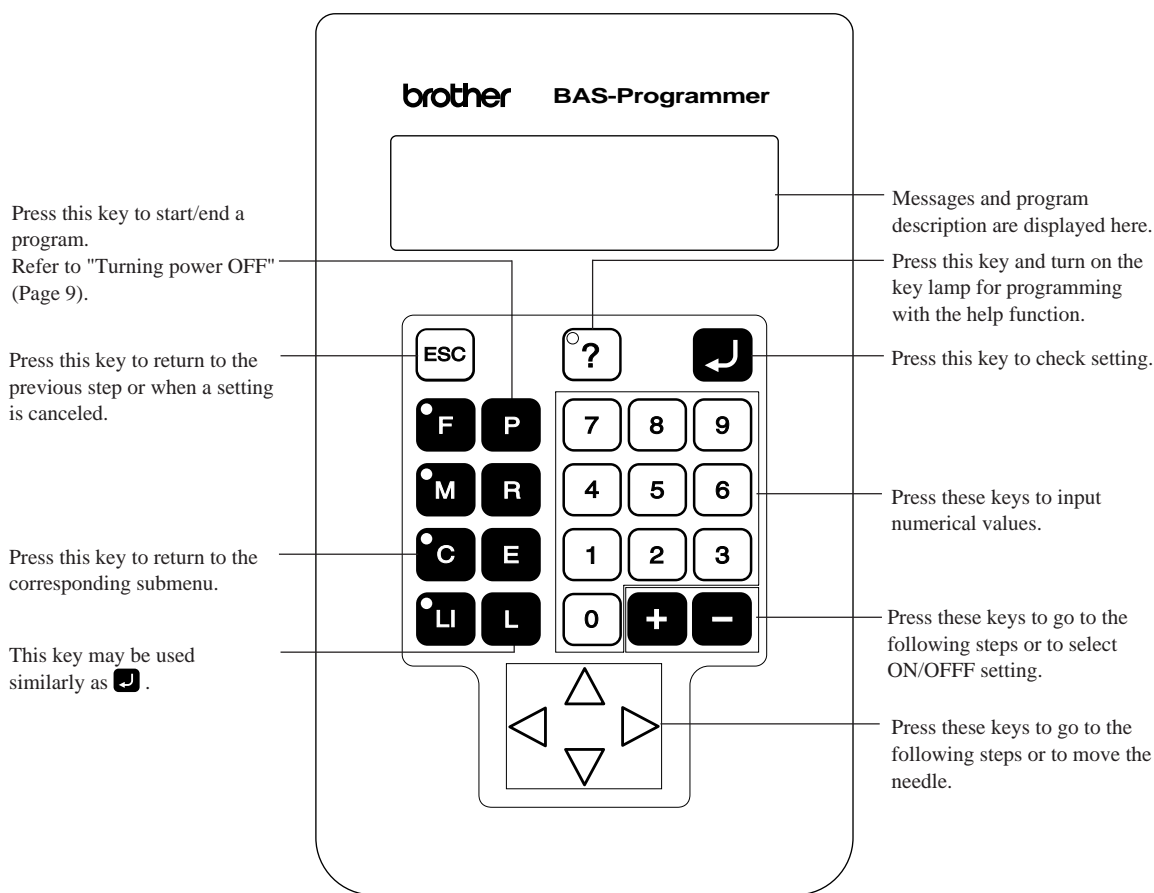

## Display screen

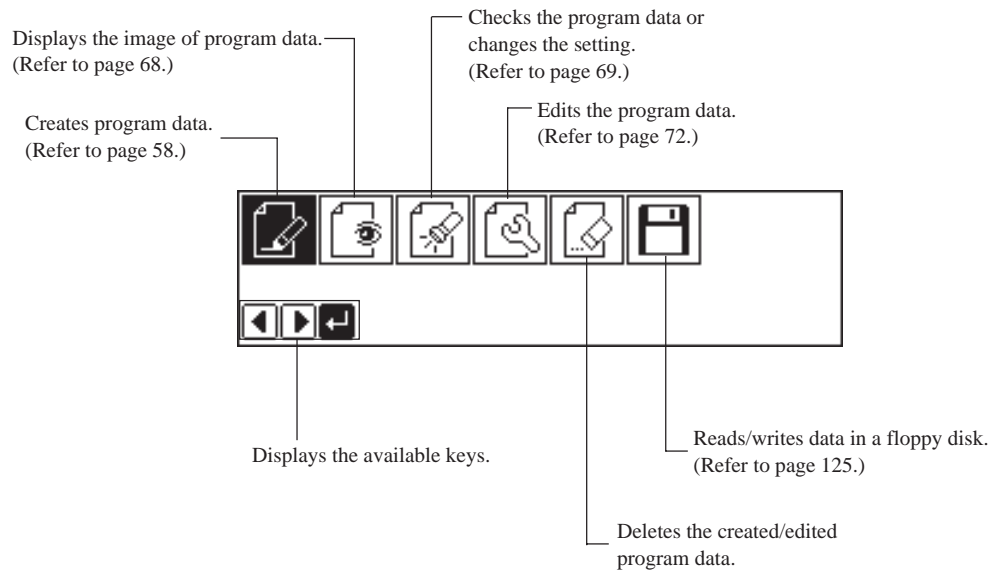

When **P** is pressed, the following screen is displayed.

If the screen is not displayed, press **?**.



## Programming flowchart

### Programming

Select , then press .





Position the sewing start position, then press .

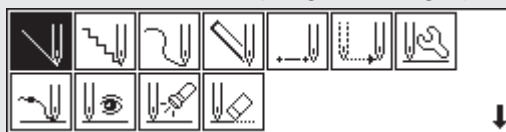

Select an icon for programming. (Refer to page 58.)





Combine straight lines, curves and other figures to make patterns on the pattern sheet. After completing each pattern, press  or  key to return to the submenu. The data is available until deletion. The program outline may be checked or corrected during editing.



Input end code. (Refer to page 65.)



## Editing program (Refer to page 72.)

Select , then press .





Select an icon for editing.



Press  after editing.

## Checking and setting (Refer to page 69.)

Select , then press .



Move to the needle position for setting.



Press  and carry out setting.

# Description of icons



## Programming



Creating a line



Creating needle tacking data



Creating a curve



Carrying out double stitch



Creating double stitch data in the reverse direction to the right side of the sewing path



Creating needle drop data



Creating feed data



Editing the current data



Moving a pattern in parallel by feeding



Moving a pattern in parallel by sewing with the specified pitch



Moving a pattern in parallel



Offsetting double stitch data to the left side of the sewing path



Offsetting double stitch data to the right side of the sewing path



Ending programming



Displaying the data image during editing



Checking the program setting and setting attribute



Deleting a part of the program



## Displaying a pattern image



## Checking the program setting and setting attribute



## Editing data



Moving a pattern in parallel



Changing a pitch



Resizing a pattern



Rotating a pattern clockwise



Rotating a pattern counterclockwise



Changing the X origin



## Deleting data

# Programming example

Frequently used programming method is explained here. Refer to "Programming" (page 58) for function and operation of each icon.

## Programming for each stitch

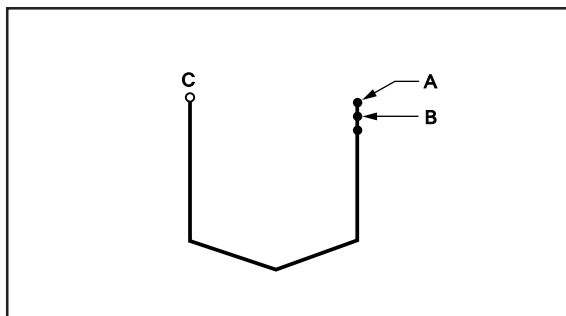

Program each stitch according to the pattern. The example in the left is used for explanation.

### 1 Programming

1. Press **P**.  
The work clamp comes down and the programmer screen is displayed.

2. Select  with **<>**, then press **J**.



3. Move the needle with **Δ▽◀▶**. Press **J** when the needle point is at point A of the pattern.

The first stitch (point A) is programmed.



4. Select  with **Δ▽◀▶**, then press **J**.

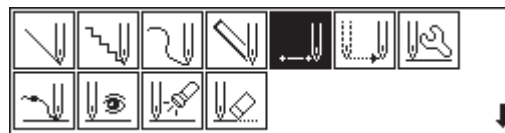

5. Move the needle with **Δ▽◀▶**. Press **J** when the needle point is at point B of the pattern.

6. Repeat step 5 and create the program to point C.

7. When point C is programmed, press **ESC**.



## 2 Inputting the end code

1. Select  with **Δ▽◀▶**, then press **↵**.

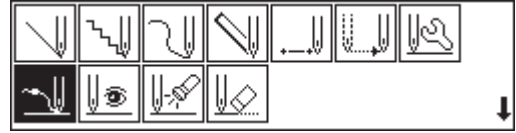

2. Press **↵**.  
The needle returns to the first stitch(point A).



3. Press **ESC**.  
The needle returns to the standby position.

## 3 Saving

Refer to "Writing data"(page 129) for detailed operation.

1. Select  with **◀▶**, then press **↵**.



2. Select  with **◀▶**, then press **↵**.



3. Input the program number, then press **↵**.



4. Press **ESC**.

## 4 Ending program

1. Press **P**.



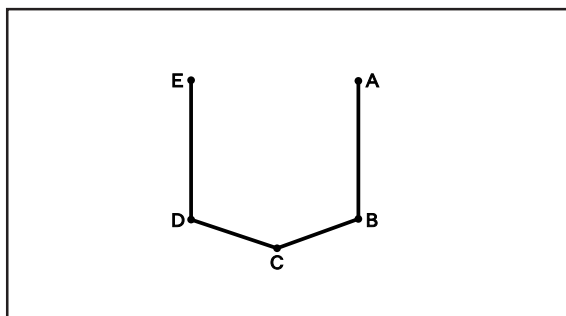

## Lines



The pattern with lines is programmed.  
The example in the left is used for explanation of programming.

### 1 Programming

- Press **P**.  
The work clamp comes down and the programmer screen is displayed.
- Select  with **<>**, then press **J**.
- Move the needle with **Δ▽<>**. Press **J** when the needle point is at point A of the pattern.  
The first stitch (point A) is programmed.
- Select  with **Δ▽<>**, then press **J**.
- Input the stitch length, then press **J**.  
3.0 mm is input in the example.  
Input 030 to make the stitch length to 3.0 mm.
- Move the needle with **Δ▽<>**. Press **J** when the needle point is at point B of the pattern.
- Repeat step 6 and create the program to point E.
- When point E is programmed, press **ESC** twice.

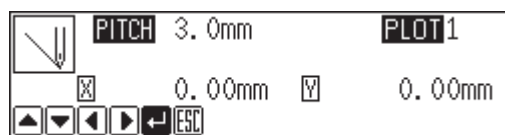
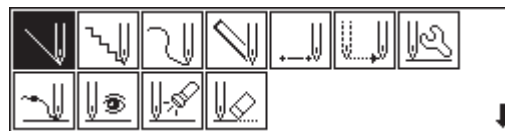

## 2 Inputting the end code

1. Select  with  $\Delta \nabla \triangleleft \triangleright$ , then press .

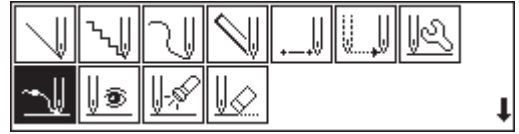

2. Press .  
The needle returns to the first stitch(point A).



3. Press .  
The needle returns to the standby position.

## 3 Saving

Refer to "Writing data"(page 129) for detailed operation.

1. Select  with  $\triangleleft \triangleright$ , then press .



2. Select  with  $\triangleleft \triangleright$ , then press .

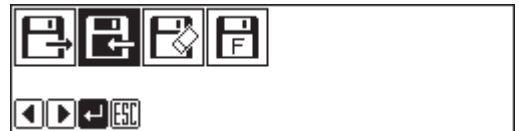

3. Input the program number, then press .



4. Press .

## 4 Ending program

1. Press .

## Curve

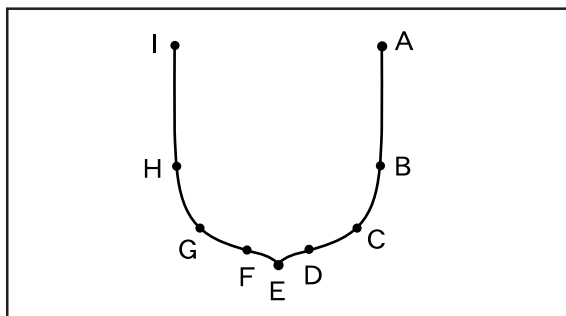

The pattern with curves is programmed. The example in the left is used for explanation of programming at the curve and the corner.

Be sure to press twice for a split at corner point E. If a split is not made, the corner will be round.

When a split is made

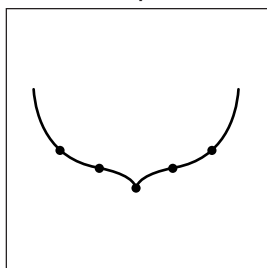

When a split is not made

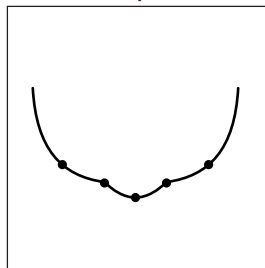

More intermediate points such as points B, C, D, F, G or H will create smooth curves.

## 1 Programming

1. Press .  
The work clamp comes down and the programmer screen is displayed.

2. Select with , then press .



3. Move the needle with . Press when the needle point is at point A of the pattern.  
The first stitch (point A) is programmed.



4. Select with , then press .

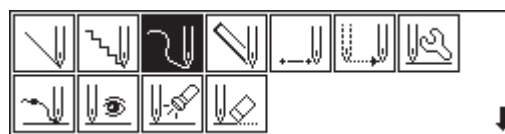







5. Input the stitch length, then press .

3.0 mm is input in the example.

Input 030 to make the stitch length to 3.0 mm.





6. Move the needle with . Press  when the needle point is at point B of the pattern.
7. Repeat step 6 and create the program to point E.

8. When point E is programmed, press  again.

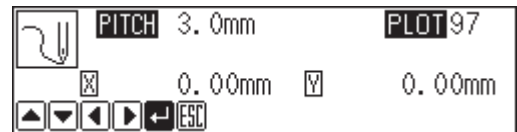
Point E becomes a corner and is programmed. To change the stitch length, press  for resetting.





9. Create the program to point I.
10. When point I is programmed, press  again.
11. Press  twice.

## Inputting the end code

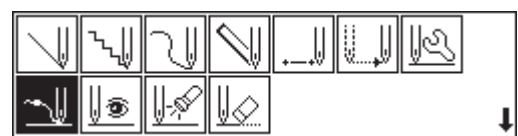
1. Select  with , then press .



2. Press .
- Press  and the needle returns to the first stitch (point A).



3. Press .
- The needle returns to the standby position.

## 3 Saving

Refer to "Writing data"(page 129) for detailed operation.

1. Select  with  , then press .



2. Select  with  , then press .



3. Input the program number, then press .



4. Press .

## 4 Ending program

1. Press .

## Double stitch

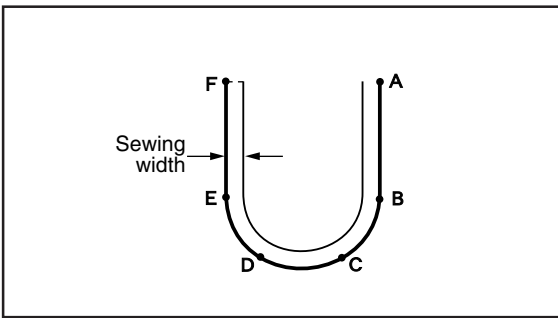

A double stitch is programmed to make two lines with a constant width.

The example in the left is used for explanation of a double stitch to the right of sewing direction.

When the line changes from straight to curve or curve to straight as in points B or E, be sure to press **↵** twice to make a split.

More intermediate points such as points C or D will create smooth curves.

## 1 Programming

1. Press **P**.  
The work clamp comes down and the programmer screen is displayed.

2. Select  with **◀▶**, then press **↵**.



3. Move the needle with **Δ▽◀▶**. Press **↵** when the needle point is at point A of the pattern.  
The first stitch (point A) is programmed.

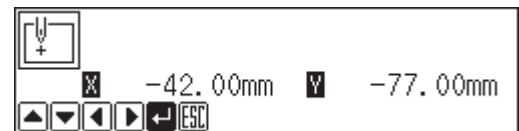

4. Select  with **Δ▽◀▶**, then press **↵**.

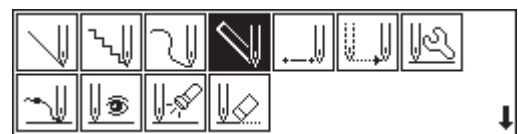







5. Input the stitch length of the double stitch.  
Press **↵**.  
3.0 mm is input in the example.  
Input 030 to make the stitch length to 3.0 mm.  
To switch input between the stitch length and the width, use **Δ▽**.



6. Select the stitch length with **▽**, then input it.  
5.0 mm is input in the example.  
Input 050 to make the stitch length to 5.0 mm.





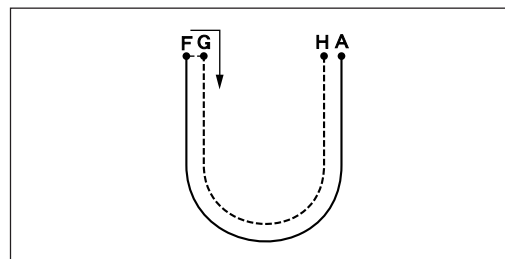
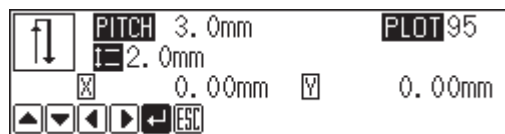

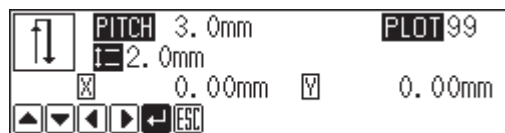

7. Press .
8. Move the needle with . Press  twice when the needle point is at point B of the pattern.
9. Program points C, D and E.
10. When point E is programmed, press  again.
11. Program point F.
12. When point F is programmed, press  again.
13. Press .  
The needle moves to points G and H.



14. When the needle stops, press  three times.



## Inputting the end code

1. Select  with , then press .
2. Press .  
Press  and the needle returns to the first stitch(point A).
3. Press .  
The needle returns to the standby position.

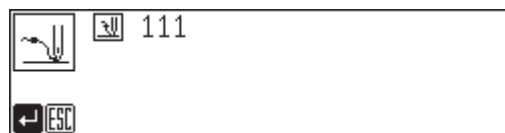
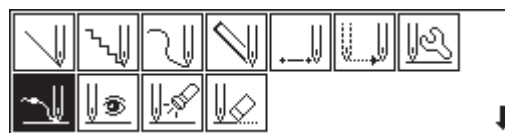

## 3 Saving

Refer to "Writing data" (page 129) for detailed operation.

1. Select  with  , then press .

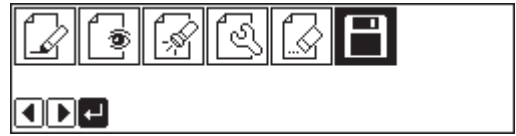

2. Select  with  , then press .



3. Input the program number, then press .



4. Press .

## A Ending program

1. Press .

### Feed

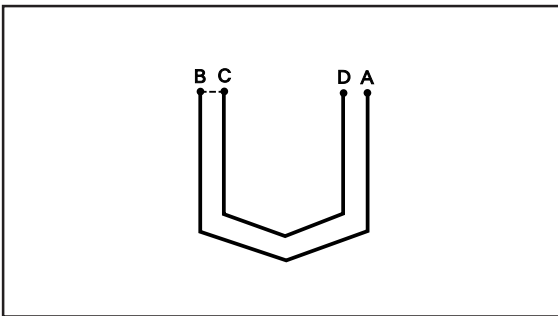

After breaking thread halfway through sewing, a feed is set to start sewing again from a different position. The example in the left is used for explanation of programming an inner pattern with a feed after an outer pattern.

## 1 Programming

1. Press .  
The work clamp comes down and the programmer screen is displayed.

2. Select  with  , then press .





3. Move the needle with  $\Delta \nabla \triangleleft \triangleright$ . Press  $\blacksquare$  when the needle point is at point A of the pattern.

The first stitch (point A) is programmed.



4. Program the outer pattern.

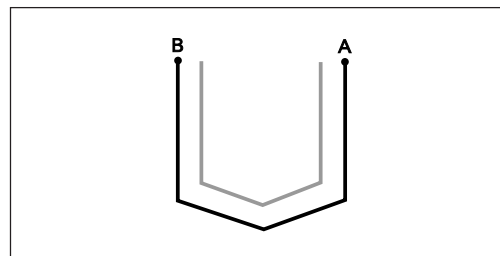

5. Press  $\text{ESC}$  after input of point B.

The number of pressing  $\text{ESC}$  depends on the programming method for outer pattern.

When  $\text{ESC}$  is used for programming, press twice.  
When each stitch is programmed, press once.

6. Select  $\text{ESC}$  with  $\Delta \nabla \triangleleft \triangleright$ , then press  $\blacksquare$ .

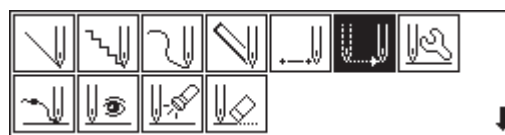

7. Move the needle with  $\Delta \nabla \triangleleft \triangleright$ . Press  $\blacksquare$  when the needle point is at point C of the pattern.

8. Press  $\text{ESC}$ .

9. Program the inner pattern.

10. When point D is programmed, press  $\text{ESC}$ .

The number of pressing  $\text{ESC}$  depends on the programming method for inner pattern.

When  $\text{ESC}$  is used for programming, press twice.  
When each stitch is programmed, press once.

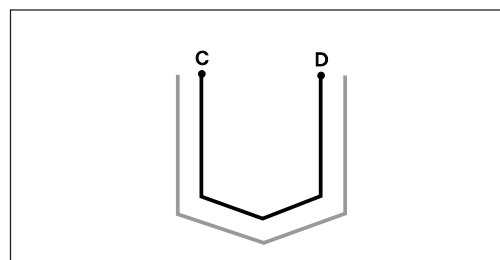

## $\text{ESC}$ Inputting the end code

1. Select  $\text{ESC}$  with  $\Delta \nabla \triangleleft \triangleright$ , then press  $\blacksquare$ .

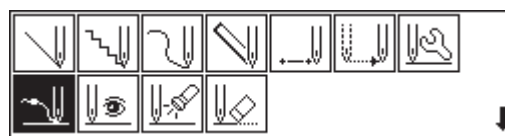

2. Press  $\blacksquare$ .

Press  $\blacksquare$  and the needle returns to the first stitch(point A).

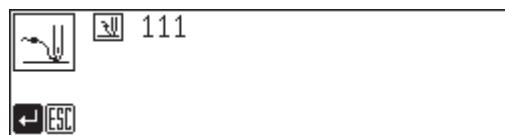

3. Press **ESC**.  
The needle returns to the home position.

## 3 Saving

Refer to "Writing data" (page 129) for detailed operation.

1. Select **F1** with **◀▶**, then press **↵**.



2. Select **F2** with **◀▶**, then press **↵**.



3. Input the program number, then press **↵**.



4. Press **ESC**.

## 4 Ending program

1. Press **P**.

## Needle racking

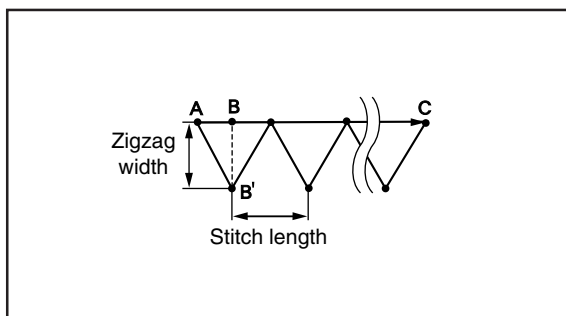

Needle tacking is programmed.

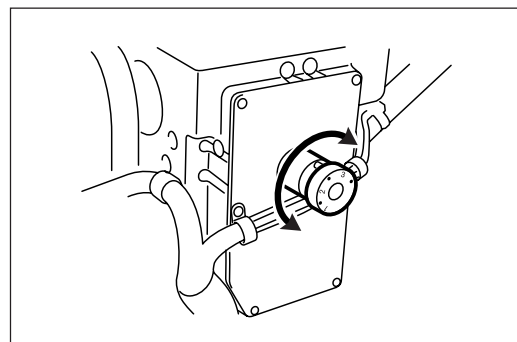

Tacking width is set with the dial on the back of the top part of the machine while needle tacking length is set with the programmer. Values 1.0 to 3.5 mm are available for the tacking width.





Values 0.1 to 1.0 mm are available for the stitch length.

The needle actually drops at the point B' because needle tacking is conducted on the machine side. However, point B of the program is created on the straight line between point A and point C.

## 1 Programming

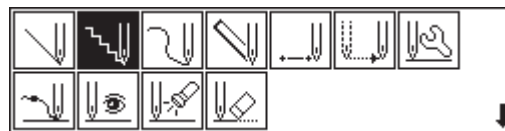
1. Create the program to point A.
2. Select  with  $\Delta \nabla \triangleleft \triangleright$ , then press .



3. Input the stitch length, then press .  
0.5 mm is input in the example.  
Input 050 to make the width and the stitch length to 0.5 mm.



4. Move the needle with  $\Delta \nabla \triangleleft \triangleright$ . Press  when the needle point is at point B of the pattern.

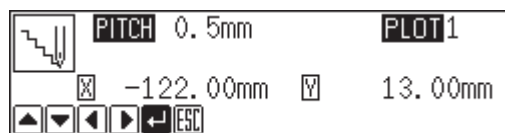

5. Press  twice.

6. Continue programming.

# Example of modified program

This section describes the modification method of the program using examples. Refer to "Programming" (page 58) or "Checking the program setting and setting attribute" (page 69) for function and operation of each icon.

## Resizing pattern

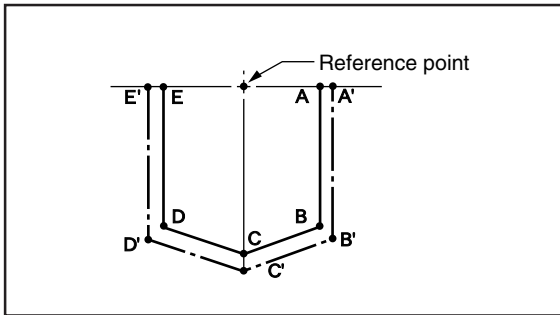

The programmed pattern is resized. The example in the left is used for explanation.

The center point (reference point) of resizing is as follows.



X coordinate: Center of the outer shape of the data

Y coordinate: Uppermost position of the data

Resizing scale between 90 to 110 % are available.













All the settings of attributes become invalid if the pattern is resized without changing the stitch length. Set the attributes after resizing the pattern.

## 1 Calling data

1. Press **P**.  
The work clamp comes down and the programmer screen is displayed.
2. Select  with **<>**, then press **↵**.
3. Select  with **<>**, then press **↵**.
4. Input the program number, then press **↵**.
5. Press **ESC**.



## 2 Resizing





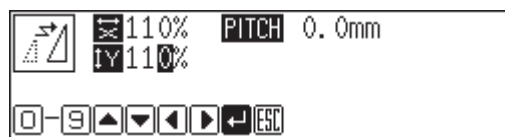
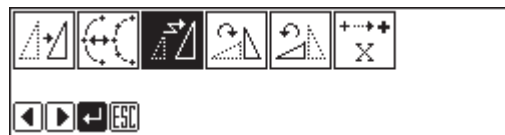





1. Select  with  , then press .
2. Select  with   , then press .
3. Input the resizing percentage for the X and the Y axes.  
110% is input in the example.  
To magnify the pattern by 110%, input 110.
4. Select the stitch length with  and input the numerical value, then press .
5. Press .

Calculation is made. The pattern is resized.



## 3 Saving

Refer to "Writing data" (page 129) for detailed operation.

1. Select  with  , then press .
2. Select  with  , then press .
3. Input the program number, then press .
4. Press .



## 4 Ending program

1. Press **P**.

### Changing partially

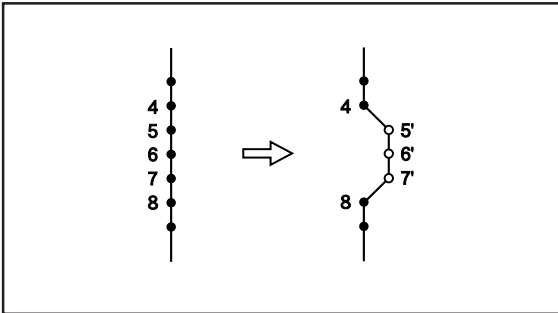

A part of the programmed pattern is changed. The example in the left is used for explanation of creating 5', 6' and 7'.

## 1 Calling data

1. Press **P**.  
The work clamp comes down and the programmer screen is displayed.

2. Select  with **<>**, then press **↵**.



3. Select  with **<>**, then press **↵**.



4. Input the program number, then press **↵**.



5. Press **ESC**.

## 2 Moving to position 4

1. Select  with **<>**, then press **↵**.



- Press **9****9****9**, then press **+**.  
The needle moves from the start position by each stitch.



- When the needle point reaches 4, press **-**.  
The needle stops. If the needle passes, input a few stitches and press **-**. The needle returns for a few stitches of the input.

- Press **ESC**.

### 3 Programming a new point

- Select  with **Δ▽◀▶**, then press **↵**.

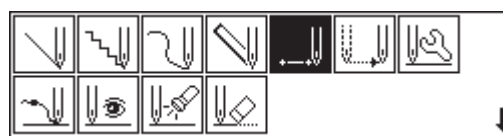

- Move the needle with **Δ▽◀▶**. Press **↵** when the needle point is at 5'.

- Repeat step 2 and program 6' and 7'.

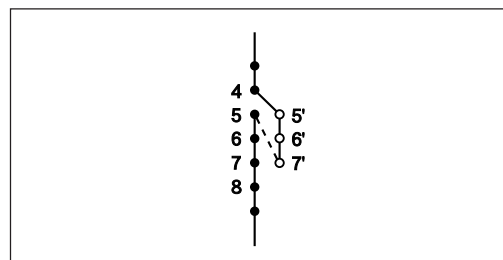

- Press **ESC**.

- Select  with **Δ▽◀▶**, then press **↵**.

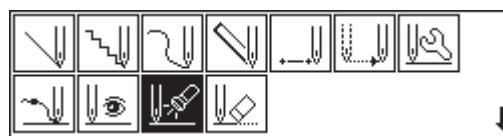

- Press **1**, then press **+**.  
The needle point moves to 5.

- Press **ESC**.

### 4 Deleting unnecessary points

- Select  with **Δ▽◀▶**, then press **↵**.

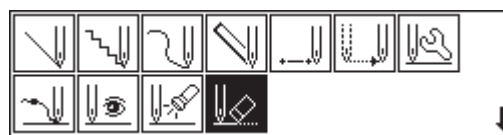

- Input the number of stitches to be deleted, then press **+**.

The example is deleting 3 stitches ahead. Press **3** **+**.

- The needle point moves to 6, 7 and 8. Points 5, 6 and 7 are deleted.

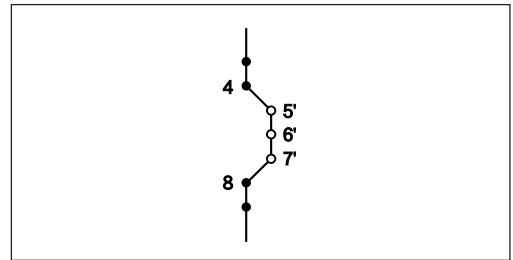

- Press **ESC** twice.

## 5 Saving

Refer to "Writing data" (page 129) for detailed operation.

- Select  with **◀▶**, then press **↵**.



- Select  with **◀▶**, then press **↵**.



- Input the program number, then press **↵**.



- Press **ESC**.

## 6 Ending program

- Press **P**.



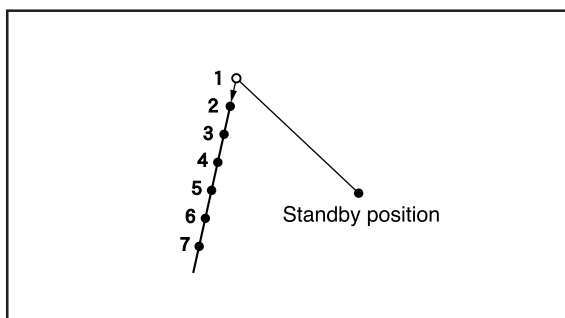

## Deleting the first stitch



The first stitch of the programmed pattern is deleted. The example in the left is used for explanation of deleting 1 and setting 2 for the sewing start position.

### 1 Calling data

- Press **P**.  
The work clamp comes down and the programmer screen is displayed.
- Select  with **<>**, then press **J**.
- Select  with **<>**, then press **J**.
- Input the program number, then press **J**.
- Press **ESC**.



### 2 Moving to position 1

- Select  with **<>**, then press **J**.
- Press **1**, then press **+**.  
The needle moves to the sewing start position.
- Press **ESC**.



## 3 Deleting 1

1. Select  with  $\Delta \nabla \triangleleft \triangleright$ , then press  $\blacktriangledown$ .

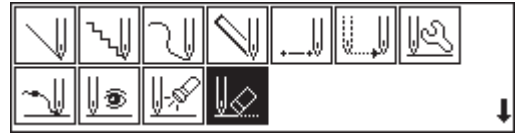

2. Input the number of stitches to be deleted, then press  $\oplus$ .

The example is deleting 1 stitch. Press  $\boxed{1} \oplus$ .

3. The needle point moves to 2.

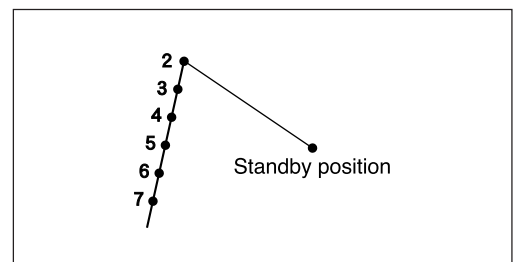

4. Press  $\text{ESC}$  twice.

## 4 Saving

Refer to "Writing data" (page 129) for detailed operation.

1. Select  with  $\triangleleft \triangleright$ , then press  $\blacktriangledown$ .



2. Select  with  $\triangleleft \triangleright$ , then press  $\blacktriangledown$ .



3. Input the program number, then press  $\blacktriangledown$ .



4. Press  $\text{ESC}$ .

## 5 Ending program

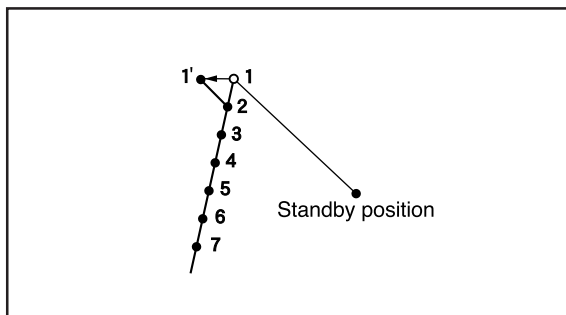

1. Press  $\text{P}$ .

## Changing the first stitch position



The position of the sewing start position is changed. The example in the left is used for explanation of moving the sewing start position from 1 to 1'.

### 1 Calling data

1. Press **P**.  
The work clamp comes down and the programmer screen is displayed.
2. Select  with **<>**, then press **↵**.
3. Select  with **<>**, then press **↵**.
4. Input the program number, then press **↵**.
5. Press **ESC**.



### 2 Moving to position 1

1. Select  with **<>**, then press **↵**.
2. Press **1**, then press **+**.  
The needle moves to the start position.
3. Press **ESC**.



### 3 Programming a new point

1. Select  with  $\Delta \nabla \triangleleft \triangleright$ , then press .

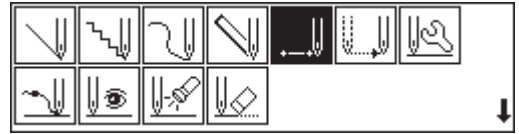



2. Move the needle with  $\Delta \nabla \triangleleft \triangleright$ . Press  when the needle point is at 1'.  
1' is programmed.

3. Press .

### 4 Deleting 1

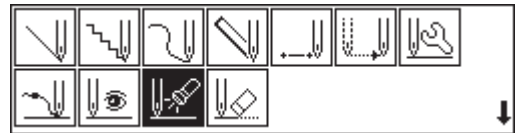
1. Select  with  $\Delta \nabla \triangleleft \triangleright$ , then press .





2. Press , then press .

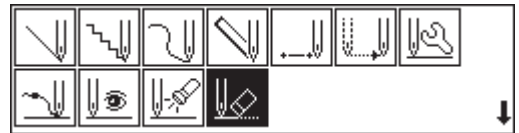

The needle moves to the sewing start position.

3. Press .

4. Select  with  $\Delta \nabla \triangleleft \triangleright$ , then press .



5. Input the number of stitches to be deleted, then press .

The example is deleting 1 stitch. Press  .

6. The needle point moves to 1'.

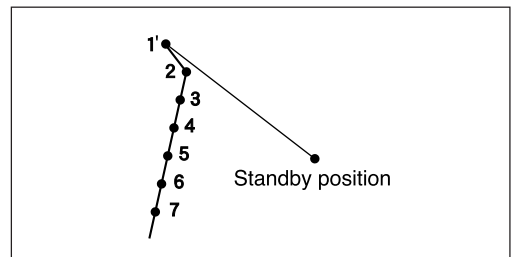

7. Press  twice.

## 5 Saving

Refer to "Writing data" (page 129) for detailed operation.

1. Select  with  , then press .



2. Select  with  , then press .



3. Input the program number, then press .



4. Press .

## 6 Ending program

1. Press .

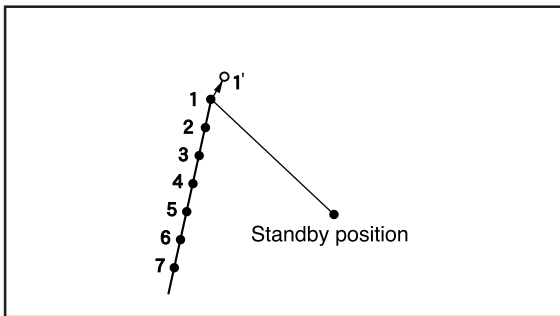

## Adding sewing point before the first stitch



A point is added before the current sewing point to change the sewing start position.

The example in the left is used for explanation of changing the sewing start position from 1 to 1'.

## 1 Calling data

1. Press **P**.  
The work clamp comes down and the programmer screen is displayed.
2. Select  with **<>**, then press **↵**.
3. Select  with **<>**, then press **↵**.
4. Input the program number, then press **↵**.
5. Press **ESC**.



## 2 Moving to position 1

1. Select  with **<>**, then press **↵**.
2. Press **1**, then press **+**.  
The needle moves to the sewing start position.
3. Press **ESC**.



## 3 Programming a new point

1. Select  with  $\Delta \nabla \triangleleft \triangleright$ , then press .

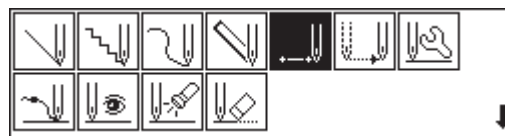

2. Move the needle with  $\Delta \nabla \triangleleft \triangleright$  so that the needle point is at 1'.

Record the coordinates (values of X and Y).

3. Press .  
1' is programmed.

4. Move the needle with  $\Delta \nabla \triangleleft \triangleright$  to the opposite position of coordinates recorded in step 2 so that the needle point is at 1 of the pattern.



5. Press .  
1 is programmed again.

6. Press .

## 4 Deleting 1

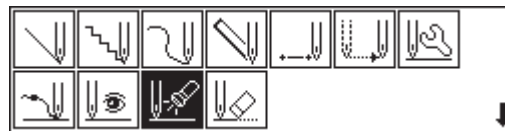
1. Select  with  $\Delta \nabla \triangleleft \triangleright$ , then press .





2. Press , then press .  
The needle moves to the sewing start position.

3. Press .

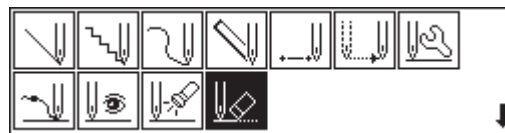
4. Select  with  $\Delta \nabla \triangleleft \triangleright$ , then press .



5. Input the number of stitches to be deleted, then press .

The example is deleting 1 stitch. Press  .

6. The needle point moves to 1'.

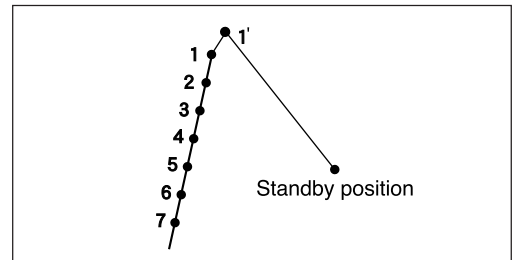

7. Press **ESC** twice.

## 5 Saving

Refer to "Writing data" (page 129) for detailed operation.

1. Select **⏏** with **◀▶**, then press **↵**.



2. Select **⏏** with **◀▶**, then press **↵**.



3. Input the program number, then press **↵**.



4. Press **ESC**.

## 6 Ending program

1. Press **P**.



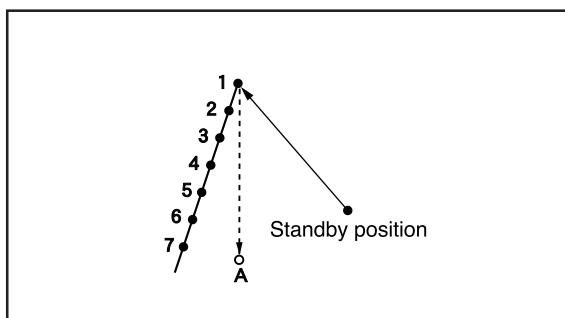

## Adding shunting point before the first stitch



An shunting point is added before the sewing start position. The example in the left is used for explanation of setting shunting point A.

The shunting point is a provisional point provided for prevention of the work clamp interference with impediments on it when it moves directly from the standby position to the sewing start position.

## 1 Calling data

- Press **P**.  
The work clamp comes down and the programmer screen is displayed.
- Select  with **<>**, then press **↵**.
- Select  with **<>**, then press **↵**.
- Input the program number, then press **↵**.
- Press **ESC**.







## 2 Moving to position 1

- Select  with **<>**, then press **↵**.
- Press **1**, then press **+**.  
The needle moves to the sewing start position.
- Press **ESC**.







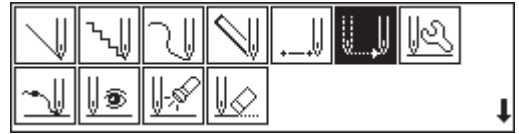





## 3 Programming a new point

1. Select  with  $\Delta \nabla \triangleleft \triangleright$ , then press .
2. Move the needle with  $\Delta \nabla \triangleleft \triangleright$  so that the needle point is at A of the pattern.  
Record the coordinates (values of X and Y).
3. Press .  
A is programmed.
4. Move the needle with  $\Delta \nabla \triangleleft \triangleright$  to the opposite position of coordinates recorded in step 2 so that the needle point is at 1 of the pattern.
5. Press .  
1 is programmed again.
6. Press .



## 4 Deleting 1

1. Select  with  $\Delta \nabla \triangleleft \triangleright$ , then press .
2. Press , then press .
3. Press .
4. Select  with  $\Delta \nabla \triangleleft \triangleright$ , then press .
5. Input the number of stitches to be deleted, then press .  
The example is deleting 1 stitch. Press  .

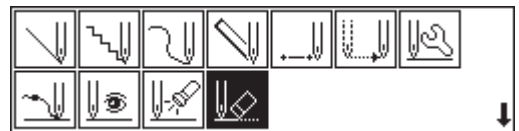
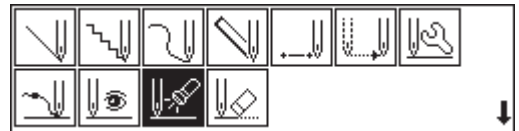

6. The needle point moves to A.

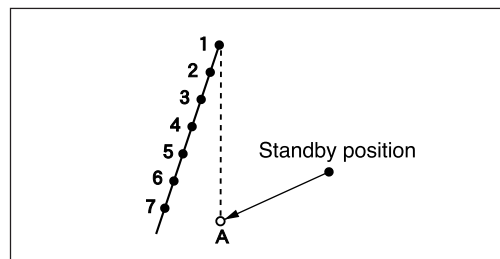

7. Press **ESC** twice.

## 5 Saving

Refer to "Writing data" (page 129) for detailed operation.

1. Select **F2** with **◀▶**, then press **↵**.



2. Select **F3** with **◀▶**, then press **↵**.



3. Input the program number, then press **↵**.



4. Press **ESC**.

## 6 Ending program

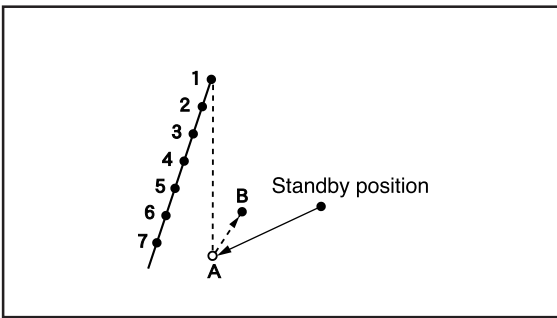

1. Press **P**.

## Moving the shunting point



The position of the shunting point is moved. The example in the left is used for explanation of moving the shunting point from A to B.

### 1 Calling data

1. Press **P**.  
The work clamp comes down and the programmer screen is displayed.
2. Select  with **◀▶**, then press **↵**.
3. Select  with **◀▶**, then press **↵**.
4. Input the program number, then press **↵**.
5. Press **ESC**.







### 2 Moving to position A

1. Select  with **◀▶**, then press **↵**.
2. Press **1** and press **+**.  
The needle moves to the start position.
3. Press **ESC**.





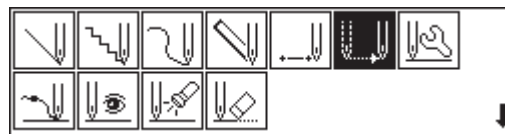

### 3 Programming a new point

1. Select  with  $\Delta \nabla \triangleleft \triangleright$ , then press .
2. Move the needle with  $\Delta \nabla \triangleleft \triangleright$ . Press  when the needle point is at B.  
B is programmed.
3. Press .





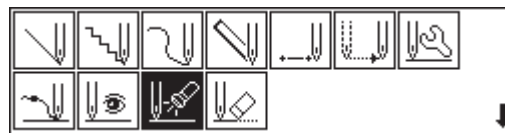

### 4 Deleting 1

1. Select  with  $\Delta \nabla \triangleleft \triangleright$ , then press .
2. Press , then press .
3. Press .

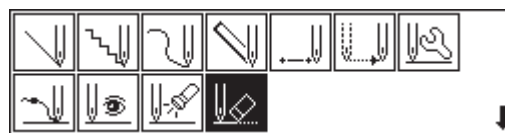

4. Select  with  $\Delta \nabla \triangleleft \triangleright$ , then press .



5. Input the number of stitches to be deleted, then press .
- The example is deleting 1 stitch. Press  .

6. The needle point moves to B.

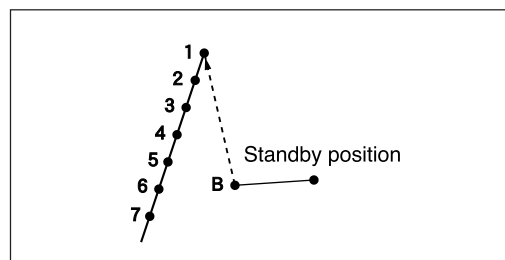

7. Press  twice.

## 5 Saving

Refer to "Writing data" (page 129) for detailed operation.

1. Select  with  , then press .

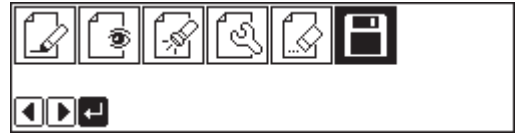

2. Select  with  , then press .



3. Input the program number, then press .



4. Press .

## 6 Ending program

1. Press .

### Deleting the shunting point

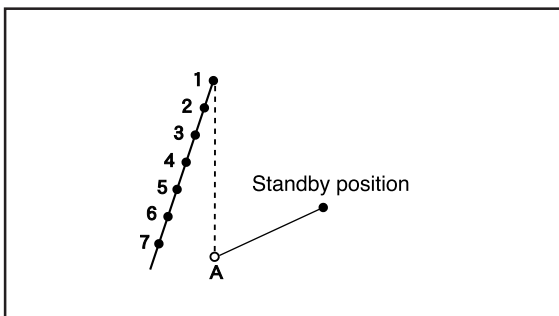

The shunting point is deleted. The example in the left is used for explanation of deleting A.

## 1 Calling data

1. Press .  
The work clamp comes down and the programmer screen is displayed.

2. Select  with  , then press .



3. Select  with , then press .



4. Input the program number, then press .





5. Press .

## 2 Moving to position A

1. Select  with , then press .





2. Press , then press .  
The needle moves to the shunting point.

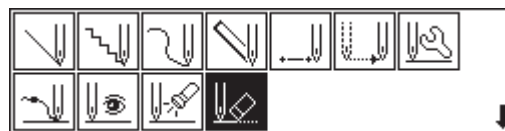

3. Press .

## 3 Deleting A

1. Select  with , then press .



2. Input the number of stitches to be deleted, then press .

The example is deleting 1 stitch. Press  .

3. The needle point moves to 1.

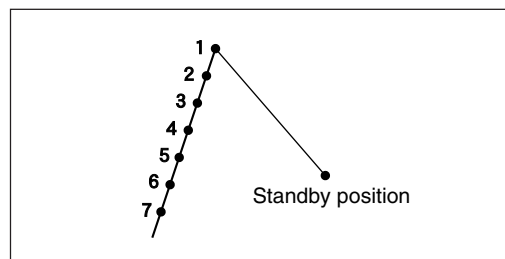

4. Press  twice.

## 4 Saving

Refer to "Writing data" (page 129) for detailed operation.

1. Select  with , then press .

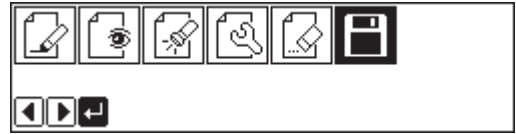

2. Select  with , then press .



3. Input the program number, then press .



4. Press .

## 5 Ending program

1. Press .

### Moving the entire pattern in parallel

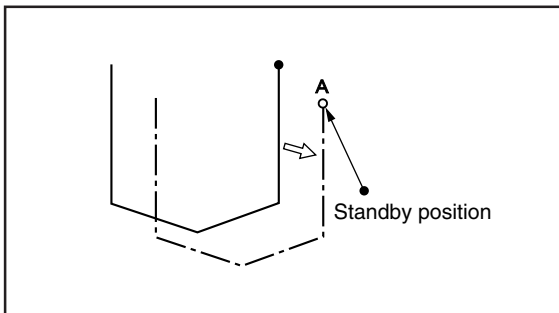

The entire program data is moved in parallel. The example in the left is used for explanation of moving the program data in parallel.

## 1 Calling data

1. Press .  
The work clamp comes down and the programmer screen is displayed.

2. Select  with , then press .





3. Select  with  $\triangleleft \triangleright$ , then press .



4. Input the program number, then press .



5. Press .

## 2 Moving

1. Select  with  $\triangleleft \triangleright$ , then press .



2. Select  with  $\triangle \nabla \triangleleft \triangleright$ , then press .

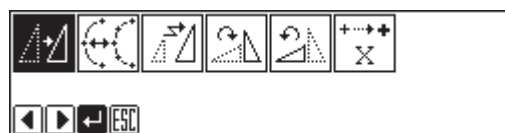

3. Move the needle with  $\triangle \nabla \triangleleft \triangleright$ . Press  when the needle point is at point A of the pattern.

4. Press .

## 3 Saving

Refer to "Writing data" (page 129) for detailed operation.

1. Select  with  $\triangleleft \triangleright$ , then press .



2. Select  with  $\triangleleft \triangleright$ , then press .



3. Input the program number, then press .



4. Press **ESC**.

## 4 Ending program

1. Press **P**.

### Deleting a part of the program during programming

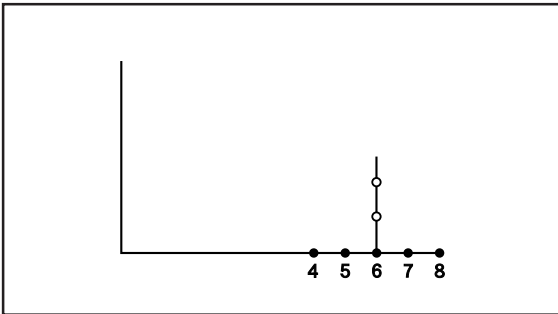

A program can be modified during programming. The example in the left is used for explanation of deleting 2 stitches at 8 and creating a new program.

1. Press **ESC** in the position 8 to display the screen on the right.

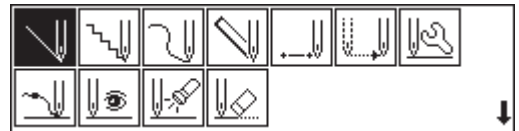

2. Select  with **Δ▽◀▶**, then press **↵**.

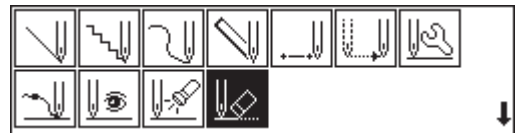

3. Input the number of stitches to be deleted, then press **−**.

The example is deleting 2 stitches backward. Press **2 −**.

4. The needle point moves to 6.



5. Press **ESC**.

6. Continue programming.





# Programming

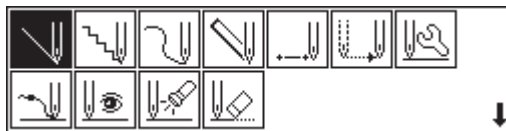

## Creating a line

1. Select , then press .



2. Input the stitch length, then press .

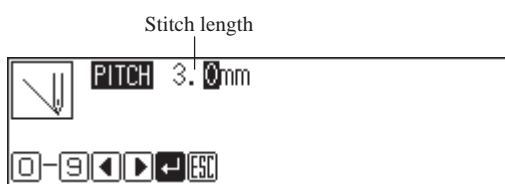

3. Move the needle with   , then press .

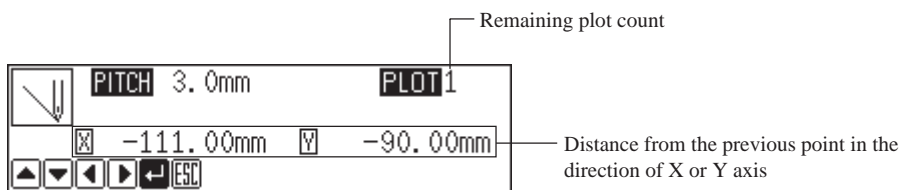

## Creating tacking data

Values 0.1 to 1.0 mm are available for the stitch length.

Tacking width of the needle is set with the dial on the back of the top part of the machine. Values 1.0 to 3.5 mm are available for the tacking width.

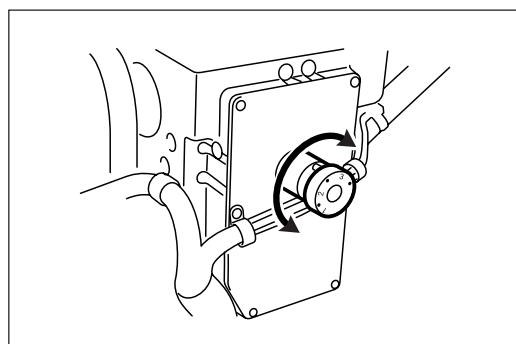

1. Select , then press .

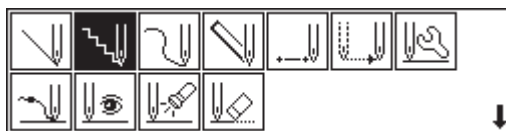

2. Input the stitch length, then press .

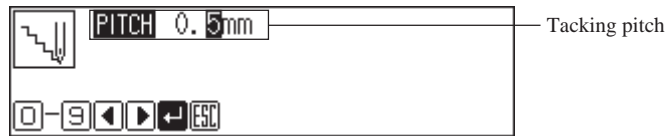

3. Move the needle with    , then press .

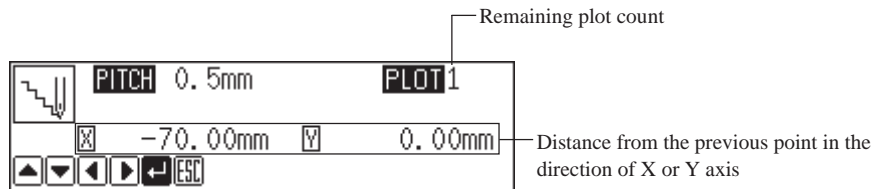

## Creating a curve

Increase the number of plotting points to create a smoother curve.  
One to 99 points are available for plotting.

1. Select , then press .

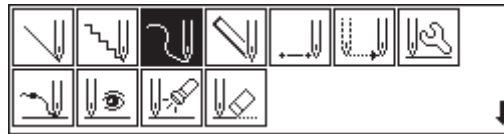

2. Input the stitch length, then press .



3. Move the needle with    , then press .

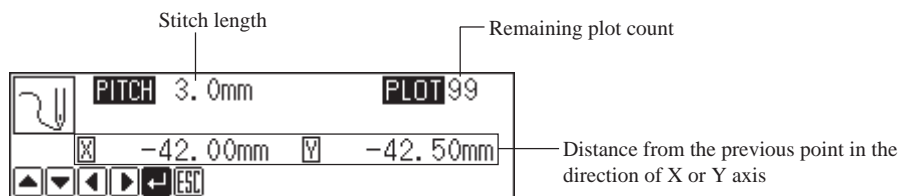

4. Press  twice at the sewing end position.

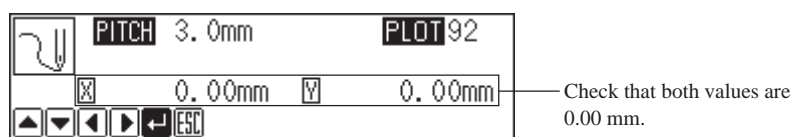



## Carrying out double stitch

Creating double stitch data in the reverse direction to the right side of the sewing path.

If sharp angles or fine curves are included in the pattern sheet, the desired double stitch may not be achieved.

Values 0.0 to 9.9 mm are available for the double stitch width.

1. Select , then press .

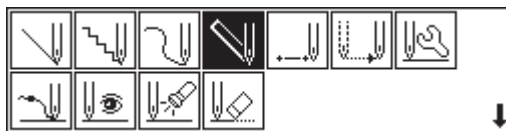

2. Input the double stitch width and the stitch length, then press .

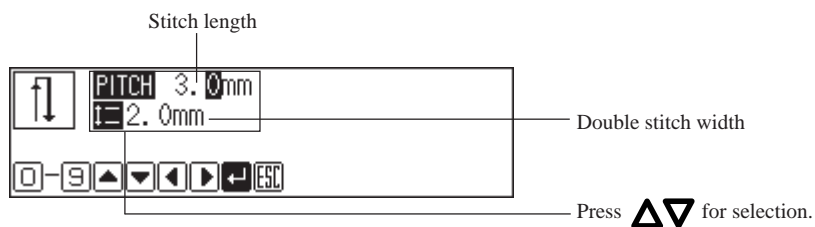

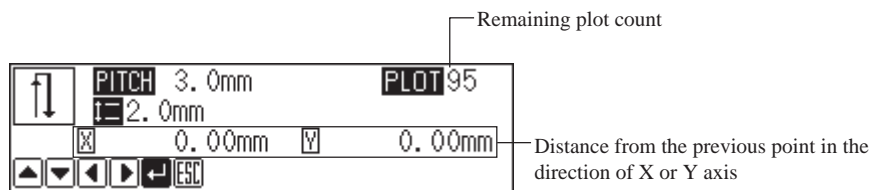

3. Move the needle with  , then press .



Press  twice to change the direction of sewing.

4. Press  at the sewing end position.

An alarm sounds after  is pressed twice. After the alarm, press  again.

Then an alarm sounds and the double stitch pattern is calculated. When the alarm stops, the needle moves in the order of A → B → C → D. The program is completed when the needle comes to D.

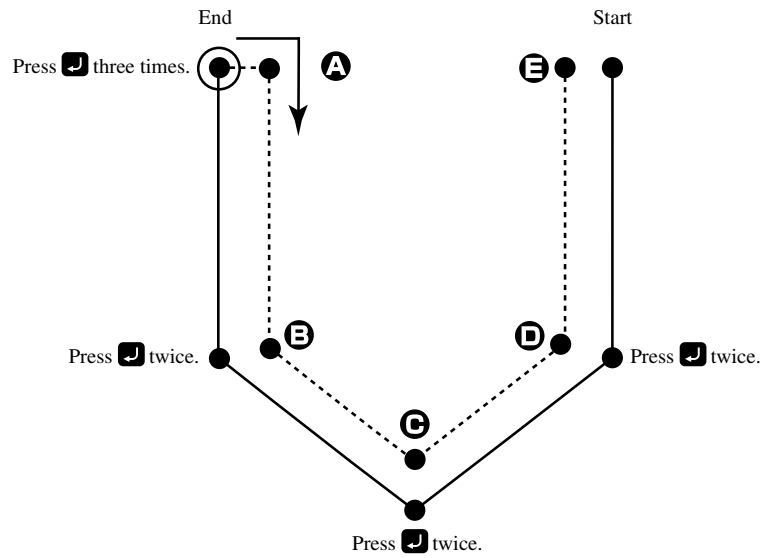



## Creating needle drop data

Create needle drop data for the current needle position.

1. Select , then press .

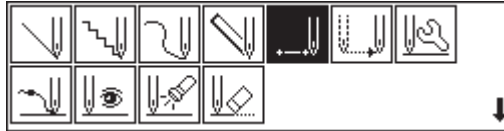

2. Move the needle with , then press .

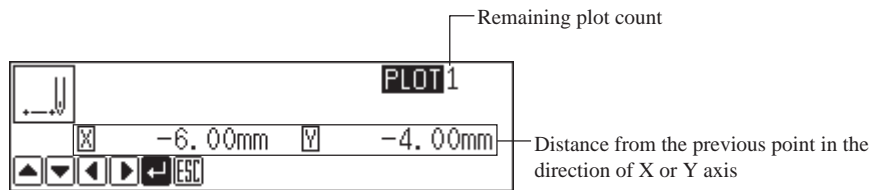

## Creating feed data

Create (feed) data of the needle to move the needle from the current position to the next without dropping it.

1. Select , then press .

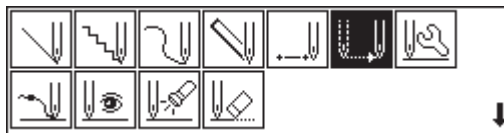

2. Move the needle with , then press .

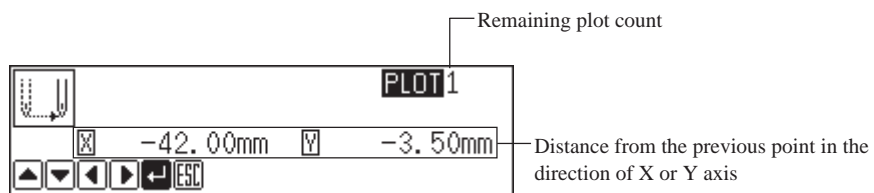



## Editing the current data

Data of the needle position after a certain position can be moved.

The following options are available as editing functions.



Moving data of the needle position after the current position in parallel by feeding

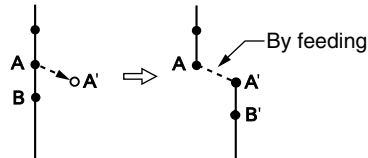

Moving data of the needle position after the current position in parallel by stitching with the specified stitch length.

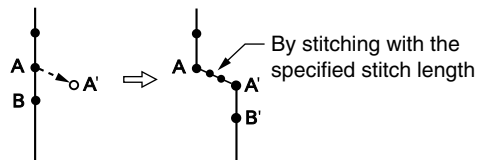

Moving data of the needle position after the current position in parallel by stitching when the moving distance is 6.0 mm or less and by feeding if it is more than 6.0 mm.

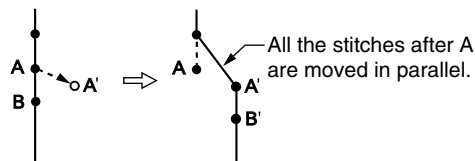

Offsetting double stitch data to the left side of the sewing path



Offsetting double stitch data to the right side of the sewing path

Adjust the needle position before editing.

Refer to "Checking the program setting and setting attribute" (page 69) for adjustment.

1. Select , then press .

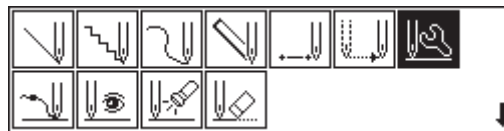



If  is selected

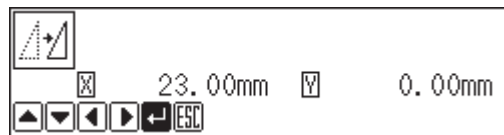

1. Adjust the destination with , then press .



If  is selected

1. Input the stitch length, then press .



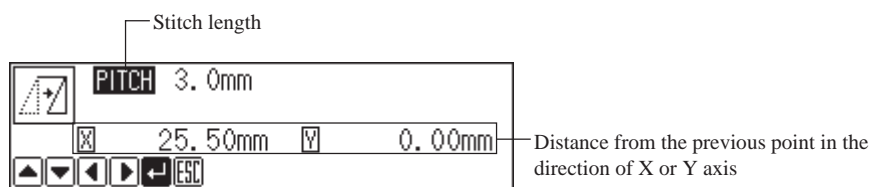

2. Adjust the destination with , then press .



If  is selected

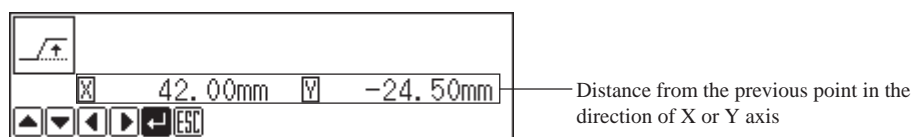

1. Adjust the destination with , then press .





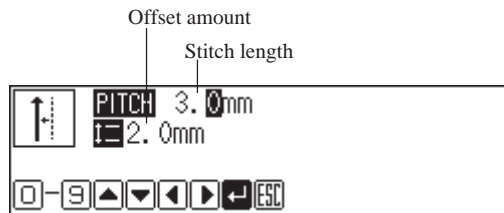

If  and  are selected

1. Input the stitch length and the offset amount, then press .

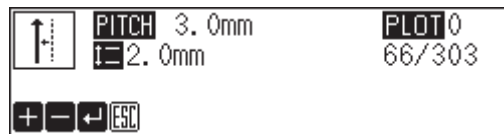

2. Move the needle to the position where offset starts with  and  , then press .



3. Move the needle to the position where offset ends with  and  , then press  twice.

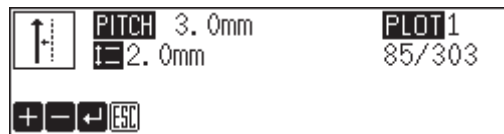

## Ending programming

When programming is completed, input an end code.

1. Select  , then press .

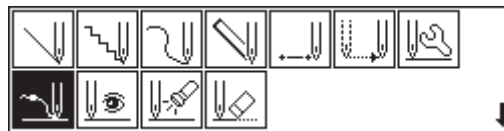

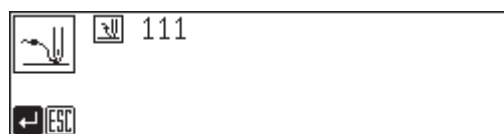

2. Press .





## Displaying the data image during programming

A data image is displayed during programming.

1. Select , then press .

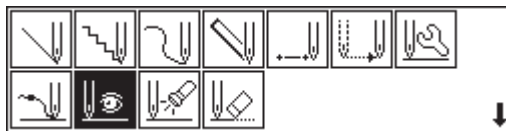

The pattern image is displayed. Press  or  to return to the main menu.

Displays the stitch count.

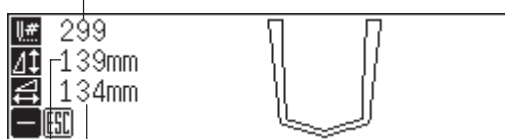

Press  to display the overall sewing area.

Displays the horizontal length.

Displays the longitudinal length.



Press  to display the overall view of sewing data.



## Checking the program setting and setting attribute

Refer to "Checking the program setting and setting attribute" (page 69).



## Deleting a part of data

Adjust the needle position before deletion.

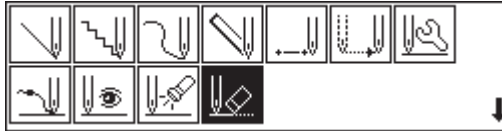

Refer to "Checking the program setting and setting attribute" (page 69) for adjustment.

1. Select , then press .

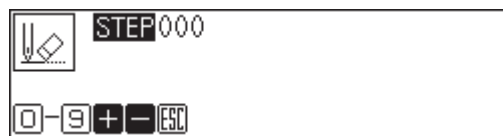

2. Input the stitch count to delete.



3. Press  to delete data following the current needle position for the input count. Press  to delete data prior to the current needle position.

The corresponding data is deleted.

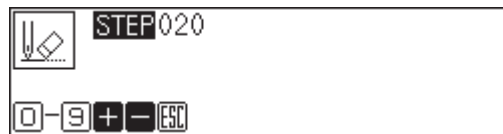



# Displaying a pattern image





A data image is displayed during programming or editing.

1. Select , then press  .

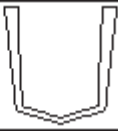

The pattern image is displayed. Press  or  to return to Main menu.

Displays the stich count.

	299	
	139mm	
	134mm	
		

Displays the lateral length.

Displays the longitudinal length.

Press  to display the overall sewing area.

	299	
	139mm	
	134mm	
		

Press  to display the overall view of sewing data.

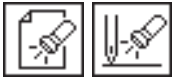

# Checking the program setting and setting attribute

Checking the program setting and setting attribute.

The following items are displayed.

End code	
Current needle position/Total stitch count	
Distance from the previous position in the X and Y axial directions	
Stitch data type	is displayed.
Needle tacking (*)	Needle tacking is set for each stitch.
Two step tension setting (*)	Two step tension output is set in the current needle position.
Two row switch (*)	The clamp is set inside when it is set to ON and is set outside when it is changed from ON to OFF.
Option output (*)	Whether option output is conducted or not is set.
Slow conversion (*)	Three successive stitches at low speed are set. Values 500 to 33500 rpm are available for the speed.
Feed data type	is displayed.
Option output (*)	Whether option output is conducted or not is set.

The cylinder operates when changing option output, two row switch, and two step tension setting.

The option output is connected to the following ports

Number of connector	P26(MN-OPT-OUT)
Number of common pin	5 or 6 (+24V)
Number of signal pin	1

Two row switch can be set only in one position in one program. The newly set point becomes valid if two row switch is already set in the program.

Attribute of items marked with \* are available for setting.

An example of stitch data is shown below.

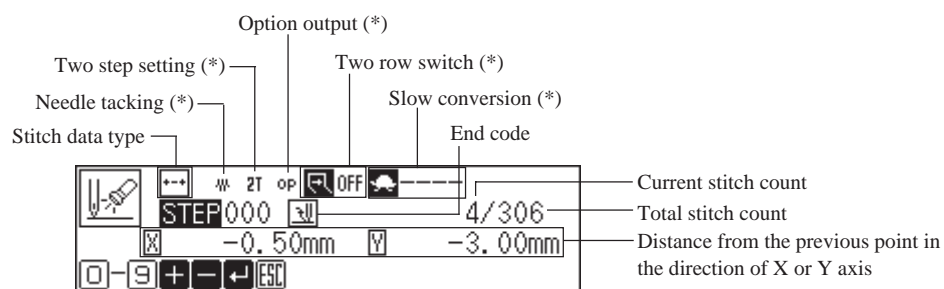

1. Select  or , then press .



Selecting from the main menu

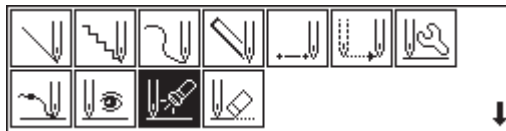

Selecting from the data programming menu



## Checking each stitch

1. Press  to move forward,  to backward.

The needle steps by each stitch and the setting of the data is displayed.



## Checking a series of stitches automatically

1. Input the stitch count to check.
2. Press  to move forward,  to backward.

The needle moves by the input count and the setting of the data is displayed.

Input "999" to check all stitches.



## Setting the attribute (stitch data)

1. Move to the desired needle position, then press .

The attribute setting screen appears.

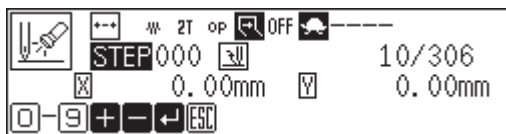

## 2. Set the attribute.

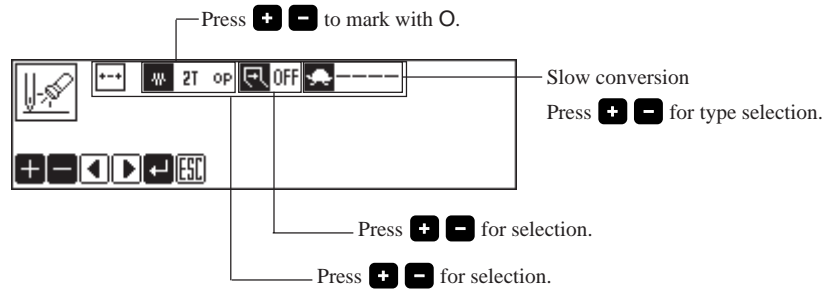
3. Press **↵** after setting.

The screen returns to the confirmation screen.



## Setting the attribute (feed data)

1. Move to the desired needle position, then press **↵**.

The attribute setting screen appears.

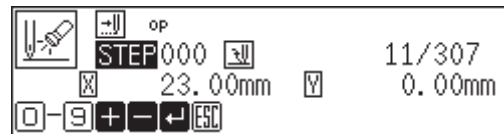

## 2. Set the attribute.

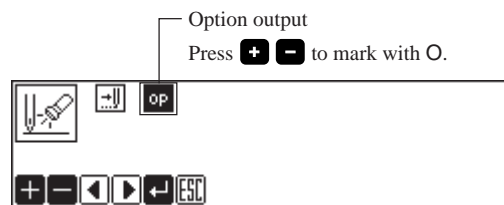
3. Press **↵** after setting.

The screen returns to the confirmation screen.











# Editing program

Edit the retrieved or created data.

The following options are available as editing functions.

	Moving a pattern in parallel. (Changes the sewing start position.)
	Changing the pitch of the program. The pitch of the needle tacking data is not changed. The following settings of attributes become invalid when changing the pitch. Set them again after changing the pitch. * Two step tension setting * Two row switch * Option output * Slow conversion
	Resizing the program in the scale between 90 to 110 %. All the settings of attributes become invalid if the pattern is resized without changing the stitch length. Set the attributes after resizing the pattern.
	Rotating a pattern clockwise in range of 1 to 359 degrees. The reference point of rotation is the center of the external shape of the data.
	Rotating a pattern counterclockwise in the range of 1 to 359 degrees. The reference point of rotation is the center of the external shape of the data.
	Modifying the X origin (the position where the working clamp holds the pocket on the folding machine side). It is available only in the help mode. The position of the working clamp can be adjusted horizontally with the position detected by the X origin sensor as 0. Values -2.0 to 5.0 mm are available for the position. The values indicated in the right side of the working clamp are positive and those indicated in the left side are negative.

1. Select , then press .



2. Select an editing function, then press .

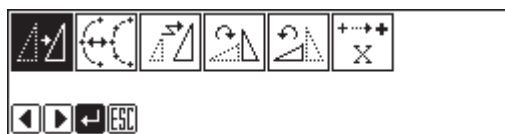

### If is selected

1. Adjust the distance in the X and Y directions with  .



2. Press  .



### If is selected

Pitch of the needle tacking data is not changed.

The following settings of attributes become invalid when the pitch is changed. Set them again after changing the pitch.

- \* Two step tension setting
- \* Two row switch
- \* Option output
- \* Slow conversion

1. Input the stitch length.



2. Press  .



If  is selected

The center point (reference point) of resizing is as follows.

X coordinate : Center of the outer shape of the data

Y coordinate : Uppermost position of the data

All the settings of attributes become invalid if the pattern is resized without changing the stitch length. Set the attributes after resizing the pattern.

1. Input resizing scale in the X and Y directions.

Switch between X and Y directions with .

Resizing scale between 90 and 110% are available.



2. Input the stitch length.

Switch between input fields of stitch length with .

If the stitch length is 0.0, the pattern is resized with the same number of stitches as the original data.



3. Press .



If  or  is selected

1. Input the angle of rotation, then press .



2. Adjust the reference position for rotation with  , then press .

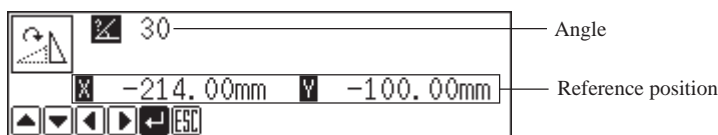

## If is selected

Only the help mode can be set.

The position of the working clamp can be adjusted horizontally with the position detected by the X origin sensor as 0. Values -2.0 and 5.0 mm are available for the position. The values indicated in the right side of the working clamp are positive and those indicated in the left side are negative.

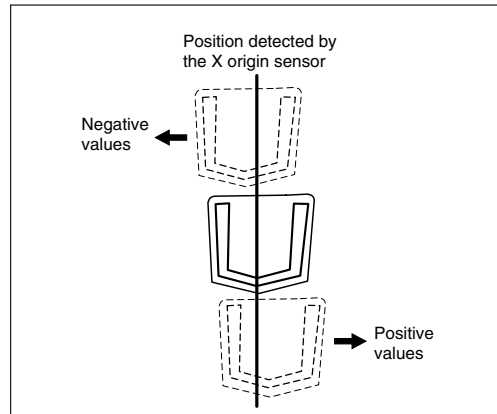

1. Input the position to be changed.

Set the + and - signs with  and .



2. Press .





## Deleting data

---

Delete the current program data.

1. Press **ESC** or **C** and return to Main menu.
2. Select , then press **J** .



3. Check the screen, then press **J** .  
Press **ESC** to cancel this command.

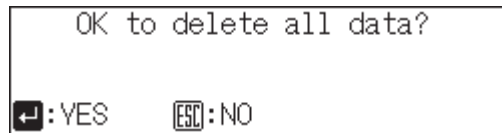

# Chapter 3

## Programming with Command Function

# Please read before programming

Pressing a designated combination of keys will issue a command to the programmer. These key combinations are called 'command'. This chapter describes the method of programming with command.

## Panel description and usage

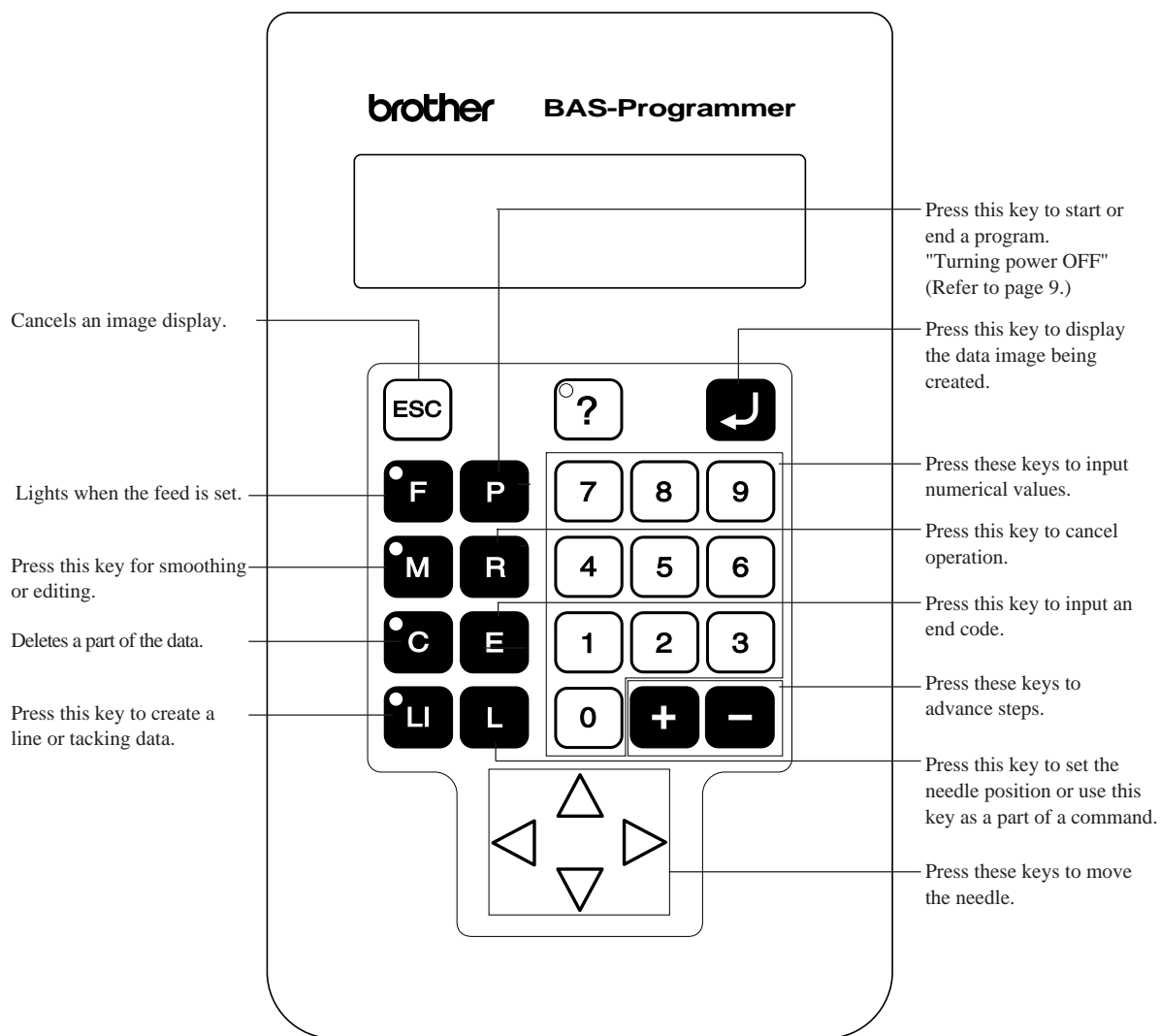

## Display screen

Press **P** and the following screen appears.

If the screen is not displayed, press **?**.

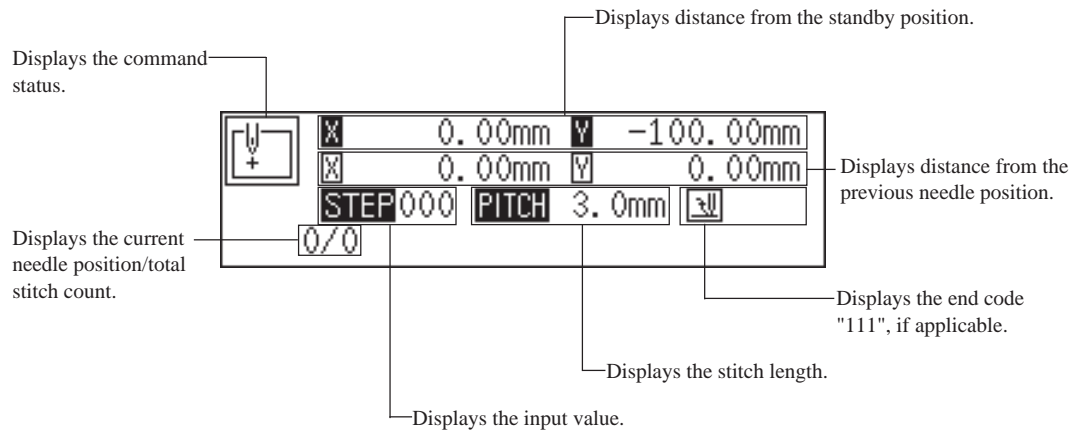

## Programming flowchart

### Programming

Position the sewing start position, then press **L**.



Input the command for programming.  
(Refer to page 105.)

Combine straight lines, curves and other figures to make patterns to the pattern sheet. After completing each pattern, press **L**.  
The data is available until deletion.



Input end code.  
(Refer to page 111.)



## Editing

Move to the standby position or the needle position for editing.



Input command for editing.  
(Refer to page 117.)

## Checking and setting

Move to the needle position for editing.



Input command and carry out setting.

# Description of commands

## Moving needle point

<input type="text"/> <input type="text"/> <input type="text"/> <b>+</b>	Proceeding by <input type="text"/> <input type="text"/> <input type="text"/> stitches
<input type="text"/> <input type="text"/> <input type="text"/> <b>-</b>	Returning by <input type="text"/> <input type="text"/> <input type="text"/> stitches
<input type="text"/> 9 <input type="text"/> 9 <input type="text"/> 9 <b>+</b>	Proceeding to the end point
<input type="text"/> 9 <input type="text"/> 9 <input type="text"/> 9 <b>-</b>	Returning to the first point
<b>R</b>	Returning the position to the standby position.

## Deleting data

<input type="text"/> 2 <input type="text"/> 2 <input type="text"/> 2 <b>R</b>	Deleting all data.
<b>C</b> <input type="text"/> <input type="text"/> <input type="text"/> <b>+</b>	Deleting data from <input type="text"/> <input type="text"/> <input type="text"/> stitches
<b>C</b> <input type="text"/> <input type="text"/> <input type="text"/> <b>-</b>	Deleting data before <input type="text"/> <input type="text"/> <input type="text"/> stitches

## Ending programming

<input type="text"/> 1 <input type="text"/> 1 <input type="text"/> 1 <b>E</b>	Ending programming
---	--------------------

## Creating program

<input type="text"/> <input type="text"/> <input type="text"/> <b>M</b>	Changing stitch length when creating a double stitch, an offset, and a curve. Input the stitch length in <input type="text"/> <input type="text"/> <input type="text"/> .
<input type="text"/> 0 <input type="text"/> <input type="text"/> <input type="text"/> <b>L</b>	Creating a line. Input the stitch length in <input type="text"/> 0 <input type="text"/> <input type="text"/> .
<input type="text"/> 0 <input type="text"/> <input type="text"/> <input type="text"/> <b>M</b>	Creating a curve. Input a stitch pitch in <input type="text"/> <input type="text"/> . Input <input type="text"/> 7 <input type="text"/> 8 <input type="text"/> 9 <b>L</b> to complete the curve data.
<input type="text"/> 2 <input type="text"/> <input type="text"/> <input type="text"/> <b>M</b>	Creating a double stitch in the reverse direction to the sewing path. Input the width of double stitch in <input type="text"/> <input type="text"/> .
<input type="text"/> 7 <input type="text"/> 8 <input type="text"/> 9 <b>L</b>	Ending input for a curve
<input type="text"/> 9 <input type="text"/> <input type="text"/> <input type="text"/> <b>M</b>	Creating needle tacking data. Input the stitch length in <input type="text"/> <input type="text"/> .
<b>F</b>	Creating feed data.

## Editing data

<b>1</b> <b>1</b> <b>1</b> <b>M</b>	Changing stitch length of the program.
<b>4</b> <input type="text"/> <input type="text"/> <b>M</b>	Offsetting to the left. Input the width to be offset in <input type="text"/> <input type="text"/> .
<b>5</b> <input type="text"/> <input type="text"/> <b>M</b>	Offsetting to the right. Input the width to be offset in <input type="text"/> <input type="text"/> .
<b>6</b> <b>6</b> <b>6</b> <b>M</b>	Rotating a pattern clockwise
<b>6</b> <b>6</b> <b>7</b> <b>M</b>	Rotating a pattern counterclockwise
<b>8</b> <b>8</b> <b>8</b> <b>M</b>	Resizing a pattern. Input the magnification in the X direction by <input type="text"/> <input type="text"/> <input type="text"/> <b>F</b> , and in the Y direction by <input type="text"/> <input type="text"/> <input type="text"/> <b>M</b> .
<b>7</b> <b>7</b> <b>7</b> <b>L</b>	Moving data of the needle position after the current position in parallel.
<b>F</b> <b>7</b> <b>7</b> <b>7</b> <b>L</b>	Moving data of the needle position after the current position in parallel by feeding.
<b>Li</b> <b>7</b> <b>7</b> <b>7</b> <b>L</b>	Moving data of the needle position after the current position in parallel by stitching with the specified stitch length.

## Setting attribute

<b>3</b> <b>3</b> <b>3</b> <b>L</b>	Setting needle tacking.
<b>3</b> <b>3</b> <b>4</b> <b>L</b>	Canceling needle tacking.
<b>6</b> <b>0</b> <b>5</b> <b>L</b>	Sewing speed of successive three stitches becomes 500 rpm.
<b>6</b> <b>0</b> <b>6</b> <b>L</b>	Canceling <b>6</b> <b>0</b> <b>5</b> <b>L</b> .
<b>6</b> <b>1</b> <b>0</b> <b>L</b>	Sewing speed of successive three stitches becomes 1000 rpm.
<b>6</b> <b>1</b> <b>1</b> <b>L</b>	Canceling <b>6</b> <b>1</b> <b>0</b> <b>L</b> .
<b>6</b> <b>1</b> <b>5</b> <b>L</b>	Sewing speed of successive three stitches becomes 1500 rpm.
<b>6</b> <b>1</b> <b>6</b> <b>L</b>	Canceling <b>6</b> <b>1</b> <b>5</b> <b>L</b> .
<b>6</b> <b>2</b> <b>0</b> <b>L</b>	Sewing speed of successive three stitches becomes 2000 rpm.
<b>6</b> <b>2</b> <b>1</b> <b>L</b>	Canceling <b>6</b> <b>2</b> <b>0</b> <b>L</b> .
<b>6</b> <b>2</b> <b>5</b> <b>L</b>	Sewing speed of successive three stitches becomes 2500 rpm.
<b>6</b> <b>2</b> <b>6</b> <b>L</b>	Canceling <b>6</b> <b>2</b> <b>5</b> <b>L</b> .
<b>6</b> <b>3</b> <b>0</b> <b>L</b>	Sewing speed of successive three stitches becomes 3000 rpm.
<b>6</b> <b>3</b> <b>1</b> <b>L</b>	Canceling <b>6</b> <b>3</b> <b>0</b> <b>L</b> .
<b>6</b> <b>3</b> <b>5</b> <b>L</b>	Sewing speed of successive three stitches becomes 3500 rpm.
<b>6</b> <b>3</b> <b>6</b> <b>L</b>	Canceling <b>6</b> <b>3</b> <b>5</b> <b>L</b> .
<b>7</b> <b>7</b> <b>1</b> <b>L</b>	Setting two step tension output.
<b>7</b> <b>7</b> <b>2</b> <b>L</b>	Canceling two step tension output.
<b>7</b> <b>7</b> <b>3</b> <b>L</b>	Turns on option output.
<b>7</b> <b>7</b> <b>4</b> <b>L</b>	Turn off option output.

---

<b>8</b>	<b>1</b>	<b>0</b>	<b>L</b>	Setting two row switch.
----------	----------	----------	----------	-------------------------

---

<b>8</b>	<b>1</b>	<b>1</b>	<b>L</b>	Canceling two row switch.
----------	----------	----------	----------	---------------------------

---

## Other operations

---

<b>ESC</b>	Returning from pattern image to the setting screen. Returning from error message to the previous screen.
------------	---

---

<b>↵</b>	Displaying data image
----------	-----------------------

---

<b>P</b>	Turning on (off) the programmer
----------	---------------------------------

---

<b>+</b> <b>-</b>	Canceling command
-------------------	-------------------

---

# Programming example

Frequently used programming method is explained here. Refer to "Programming" (page 105) for function and operation of each icon.

## Programming for each stitch

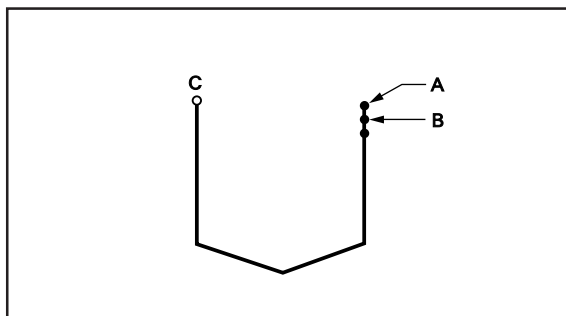

Program each stitch according to the pattern. The example in the left is used for explanation.

## 1 Programming

1. Press **P**.  
The work clamp comes down and the programmer screen is displayed.
2. Move the needle with **Δ▽◀▶**. Press **L** when the needle point is at point A of the pattern.  
The first stitch (point A) is programmed.
3. Repeat step 2 and create the program to point C.

## 2 Inputting the end code

1. Press **L** at the last stitch and press **1 1 1 E**.  
The needle returns to the sewing start position.

## 3 Saving

1. Specify the program number on the operation panel, then press **↵** switch for writing into the floppy disk.  
Refer to "Using the operation panel of the main body" (page 129) for detailed operation.

## 4 Ending program

1. Press **P**.

### Lines

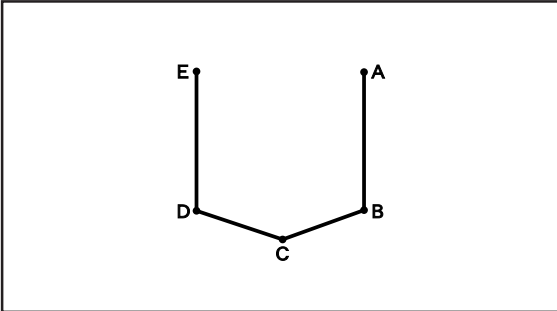

The pattern with lines is programmed.  
The example in the left is used for explanation of programming.

## 1 Programming

1. Press **P**.  
The work clamp comes down and the programmer screen is displayed.
2. Move the needle with **Δ▽◀▶**. Press **L** when the needle point is at point A of the pattern.  
The first stitch (point A) is programmed.
3. Input the stitch length.  
3.0 mm is input in the example.  
Input 030 to make the stitch length to 3.0 mm.
4. Press **U**.  
To change the stitch length, specify the pitch value before pressing **U**.
5. Move the needle with **Δ▽◀▶**. Press **L** when the needle point is at point B of the pattern.
6. Repeat steps 4 and 5 and create the program to point E.



## 2 Inputting the end code

1. Press **1 1 1 E**.  
The needle returns to the sewing start position.

## 3 Saving

1. Specify the program number on the operation panel, then press  switch for writing into the floppy disk.

Refer to "Using the operation panel of the main body"(page 131) for detailed operation.

## 4 Ending program

1. Press .

### Curve

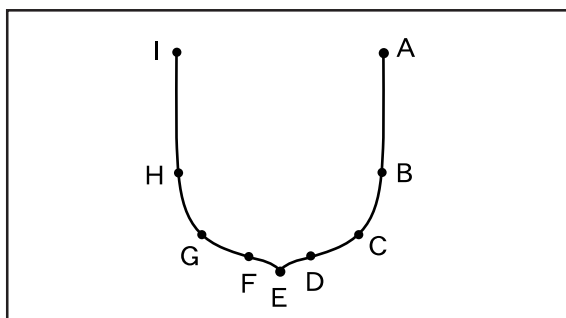

A pattern with curves is programmed.

Be sure to press     for a split at corner point E. If a split is not made, the corner will be round.

When a split is made

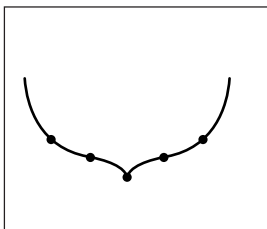

When a split is not made

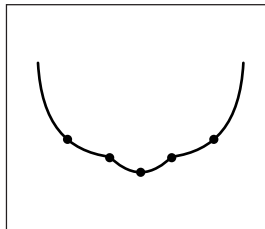

More intermediate points such as points B, D, F, G or H will create smooth curves.

## 1 Programming

1. Press .  
The work clamp comes down and the programmer screen is displayed.

2. Move the needle with  $\Delta \nabla \leftarrow \rightarrow$ . Press **L** when the needle point is at point A of the pattern.

The first stitch (point A) is programmed.

3. Input the stitch length, then press **M**.

3.0 mm is input in the example.

Input 030 to make the stitch length to 3.0 mm.



4. Move the needle with  $\Delta \nabla \leftarrow \rightarrow$ . Press **L** when the needle point is at point B of the pattern.

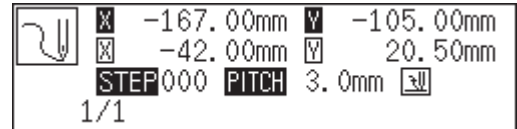

5. Repeat step 4 and create the program to point D.

6. Move the needle with  $\Delta \nabla \leftarrow \rightarrow$ . Press **7 8 9 L** when the needle point is at point E of the pattern.

Point E becomes a sharp corner.

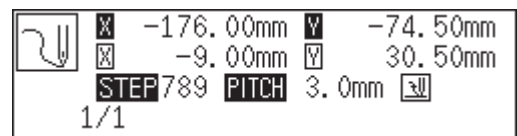

7. Press **M**.

To change the stitch length, specify the pitch value before pressing **M**.

8. Repeat step 4 and create the program from points F to H.

9. Press **7 8 9 L** as in step 6 at point I.

The range from points C to E is programmed.

## 2 Inputting the end code

1. Press **1 1 1 E**.

The needle returns to the sewing start position.

## 3 Saving

1. Specify the program number on the operation panel, then press **↵** switch for writing into the floppy disk.

Refer to "Using the operation panel of the main body"(page 131) for detailed operation.



## 4 Ending program

1. Press **P**.

### Double stitch

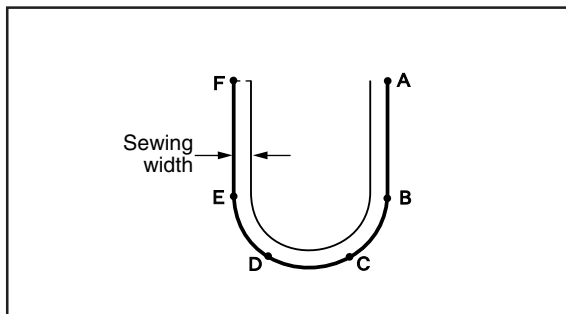

A double stitch is programmed to make two lines with a constant width.

The example in the left is used for explanation of a double stitch to the right of sewing direction.

When the line changes from straight to curve or curve to straight as in points B or E, be sure to press **7 8 9 L** to make a split.

More intermediate points such as points C or D will create smooth curves.

## 1 Programming

1. Press **P**.  
The work clamp comes down and the programmer screen is displayed.
2. Move the needle with **Δ ▽ ◀ ▶**. Press **L** when the needle point is at point A of the pattern.  
The first stitch (point A) is programmed.

3. Press **2 3 0**, then press **M**.  
**2** is the command for the double stitch. Input the width of the double stitch in **3 0**. 3.0 mm is input in the example.



4. Input the stitch length, then press **M**.  
3.0 mm is input in the example.  
Input 030 to make the stitch length to 3.0 mm.



5. Create the program to point F in the similar manner of curve program.  
If a straight line is present as in the example, press **7 8 9 L** in the position where the curve is changed to the straight, and vice versa.

## 2 Inputting the end code

1. Press **1 1 1 E**.  
The needle goes back to the sewing start position after moving to points G and H.  
To stitch between point H and point A, press **9 9 9 +** to put the needle position on point H and stitch a straight line to point A, then press **1 1 1 E**.

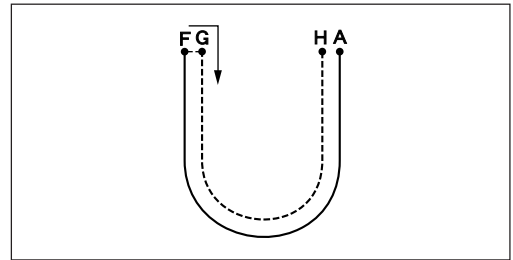

## 3 Saving

1. Specify the program number on the operation panel, then press **⏺** switch for writing into the floppy disk.  
Refer to "Using the operation panel of the main body"(page 131) for detailed operation.

## 4 Ending program

1. Press **P**.

### Feed

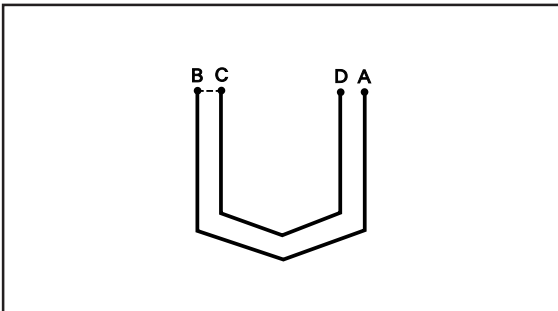

After breaking thread halfway through sewing, a feed is set to start sewing again from a different position. The example in the left is used for explanation of programming an inner pattern with a feed after an outer pattern.

## 1 Programming

1. Press **P**.  
The work clamp comes down and the programmer screen is displayed.
2. Move the needle with **Δ ▽ ◀ ▶**. Press **L** when the needle point is at point A of the pattern.  
The first stitch (point A) is programmed.

3. Program the outer pattern.

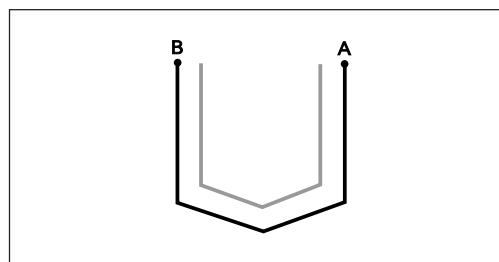

4. Input point B, then press **F**.

5. Move the needle with **Δ▽◀▶**. Press **L** when the needle point is at point C of the pattern.

6. Program the inner pattern.

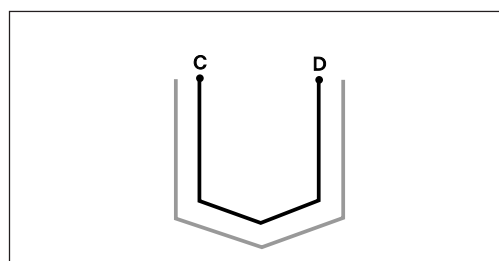

## 2 Inputting the end code

1. Press **1 1 1 E**.  
The needle returns to the sewing start position.

## 3 Saving

1. Specify the program number on the operation panel, then press **⏺** switch for writing into the floppy disk.  
Refer to "Using the operation panel of the main body"(page 131) for detailed operation.

## 4 Ending program

1. Press **P**.

## Needle racking

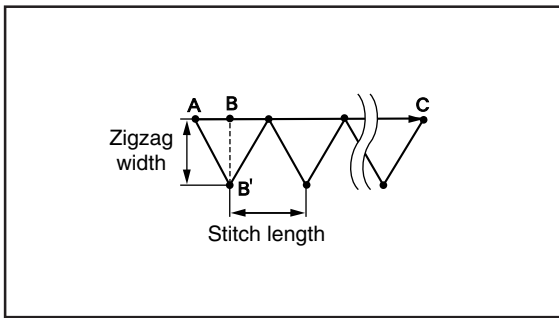

Needle tacking is programmed.

Tacking width is set with the dial on the back of the top part of the machine while needle tacking length is set with the programmer. Values 1.0 to 3.5 mm are available for the tacking width.

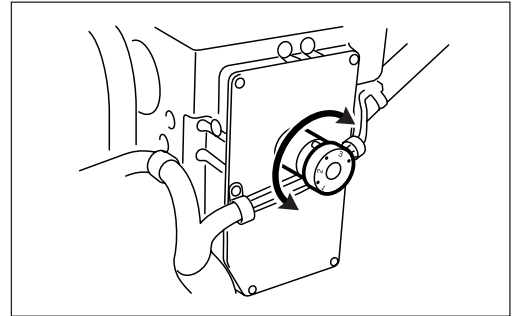

Values 0.1 to 1.0 mm are available for the stitch length.

The needle actually drops at the point B' because needle tacking is conducted on the machine side. However, point B of the program is created on the straight line between point A and point C.

## 1 Programming

1. Create the program to point A.
2. Move the needle with  $\Delta \nabla \leftarrow \rightarrow$ . Press **L** when the needle point is at point A of the pattern.  
The first stitch (point A) is programmed.
3. Press **9**   , then press **M**.  
**9**    is the command for the tacking. Input the width of the tacking in  . 0.5 mm is input in the example.
4. Move the needle with  $\Delta \nabla \leftarrow \rightarrow$ . Press **L** when the needle point is at point C of the pattern.
5. Continue programming.

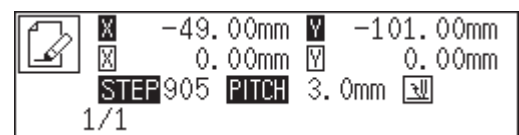

# Example of modified program

This section describes the modification method of the program using examples. Refer to "Programming" (page 105).

## Resizing pattern

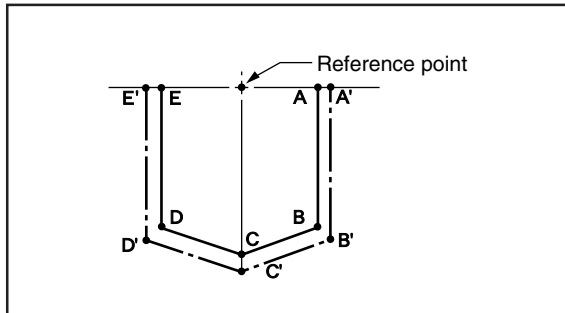

The programmed pattern is resized. The example in the left is used for explanation.

The center point (reference point) of resizing is as follows.

X coordinate : Center of the outer shape of the data

Y coordinate : Uppermost position of the data

Resizing scale between 90 to 110 % are available.

All the settings of attributes become invalid if the pattern is resized without changing the stitch length. Set the attributes after resizing the pattern.

## 1 Calling data

1. Specify the program number on the operation panel, then press switch to read the data.  
Refer to "Using the operation panel of the main body"(page 128) for detailed operation.

## 2 Resizing

1. Press , then press .  
Input the resizing command.



2. Press , then press .  
Input the resizing percentage for the X axis. Specify the magnification percentage by 3 digits in . 90% is specified in the example.



3. Press , then press .  
Input the resizing percentage for the Y axis. Specify the magnification percentage by 3 digits in . 90% is specified in the example.

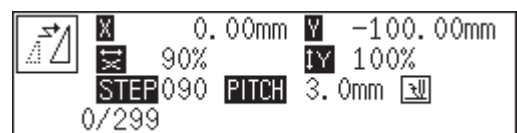

If the stitch length is 0.0, the pattern is resized with the same number of stitches as the original data.



## 3 Saving

1. Specify the program number on the operation panel, then press switch for writing into the floppy disk.

Refer to "Using the operation panel of the main body"(page 131) for detailed operation.

## 4 Ending program

1. Press **P**.

## Changing partially

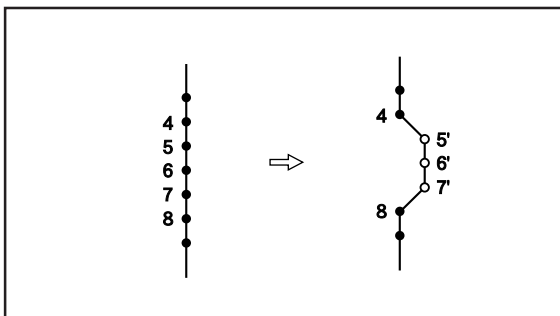

A part of the programmed pattern is changed. The example in the left is used for explanation of creating 5', 6' and 7'.

## 1 Calling data

1. Specify the program number on the operation panel, then press switch to read the data.  
Refer to "Using the operation panel of the main body"(page 128) for detailed operation.

## 2 Moving to position 4

1. Press **9****9****9**, then press **+**.  
The work clamp comes down and the programmer screen is displayed.
2. When the needle point reaches 4, press **-**.  
The needle stops. If the needle passes, input a few stitches and press **-**. The needle returns for a few stitches of the input.

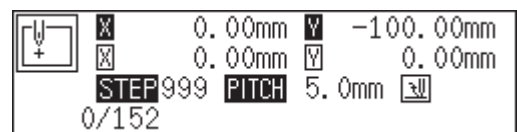

## 3 Programming a new point

1. Move the needle with  $\Delta \nabla \triangleleft \triangleright$ . Press **L** when the needle point is at 5'.  
5' is programmed.
2. Repeat step 1 and program 6' and 7'.

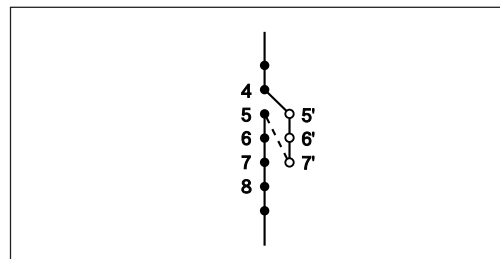

3. Press **1**, then press **+**.  
The needle point moves to 5.

## 4 Deleting unnecessary points

1. Press **C**.
2. Input the number of stitches to be deleted, then press **+**.  
The example is deleting 3 stitches ahead. Press **3** **+**.
3. The needle point moves to 6, 7 and 8. Points 5, 6 and 7 are deleted.

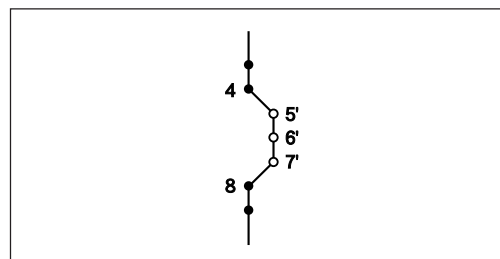

## 5 Saving

1. Specify the program number on the operation panel, then press **W** switch for writing into the floppy disk.  
Refer to "Using the operation panel of the main body"(page 131) for detailed operation.

## 6 Ending program

1. Press **P**.

## Deleting the first stitch

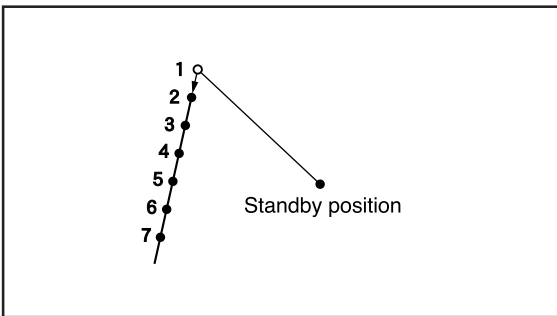



The first stitch of the programmed pattern is deleted. The example in the left is used for explanation of deleting 1 and setting 2 for the sewing start position.





### 1 Calling data

1. Specify the program number on the operation panel, then press  switch to read the data. Refer to "Using the operation panel of the main body"(page 128) for detailed operation.

### 2 Moving to position 1

1. Press , then press .  
The needle moves to the sewing start position.

### 3 Deleting 1

1. Press .
2. Input the number of stitches to be deleted, then press .  
The example is deleting 1 stitch ahead. Press  .
3. The needle point moves to 2.

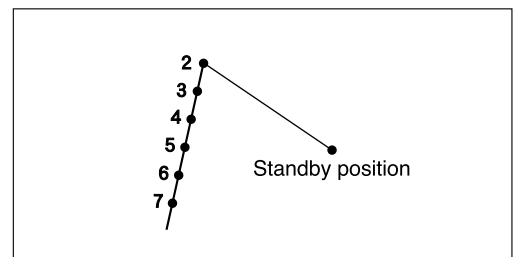

### 4 Saving

1. Specify the program number on the operation panel, then press  switch for writing into the floppy disk. Refer to "Using the operation panel of the main body"(page 131) for detailed operation.



## 4 Ending program

1. Press **P**.

### Changing the first stitch position

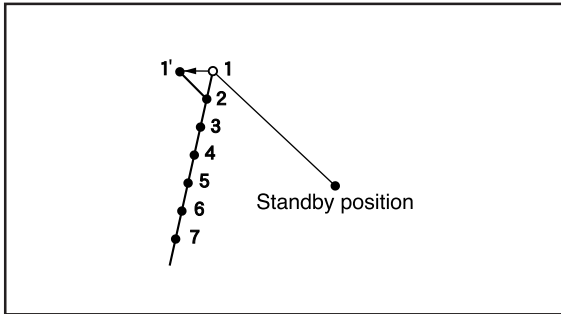

The position of the sewing start position is changed. The example in the left is used for explanation of moving the sewing start position from 1 to 1'.

## 1 Calling data

1. Specify the program number on the operation panel, then press **ENTER** switch to read the data.  
Refer to "Using the operation panel of the main body"(page 128) for detailed operation.

## 2 Moving to position 1

1. Press **1**, then press **+**.  
The needle moves to the sewing start position.

## 3 Programming a new point

1. Move the needle with **▲▼◀▶**. Press **L** when the needle point is at 1' of the pattern.  
1' is programmed.

## 4 Deleting 1

1. Press **1**, then press **-**.  
The needle point returns to the first stitch.
2. Press **C**.
3. Input the number of stitches to be deleted, then press **+**.  
The example is deleting 1 stitch. Press **1** **+**.

- The needle point moves to 1'.

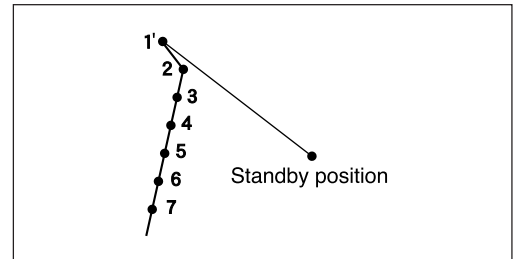

## 5 Saving

- Specify the program number on the operation panel, then press  switch for writing into the floppy disk.

Refer to "Using the operation panel of the main body"(page 131) for detailed operation.

## 6 Ending program

- Press .

### Adding sewing point before the first stitch

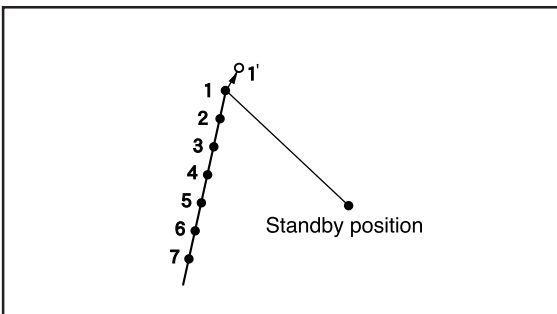

A point is added before the current sewing point to change the sewing start position.

The example in the left is used for explanation of changing the sewing start position from 1 to 1'.

## 1 Calling data

- Specify the program number on the operation panel, then press  switch to read the data.

Refer to "Using the operation panel of the main body"(page 128) for detailed operation.

## 2 Moving to position 1

- Press , then press .

The needle moves to the sewing start position.

## 3 Programming a new point

1. Move the needle with  $\Delta \nabla \triangleleft \triangleright$  so that the needle point is at 1' of the pattern.

Record the coordinates (values of  $\boxtimes$  and  $\boxvee$ ).



2. Press **L**.  
1' is programmed.
3. Move the needle with  $\Delta \nabla \triangleleft \triangleright$  to the opposite position of coordinates recorded in step 2, then press **L**.
4. Press **2**, then press **-**.  
The needle moves to the sewing start position.

## 4 Deleting 1

1. Press **1**, then press **+**.  
The needle point returns to the first stitch.
2. Press **C**.
3. Input the number of stitches to be deleted, then press **+**.  
The example is deleting 1 stitch. Press **1** **+**.
4. The needle point moves to 1'.

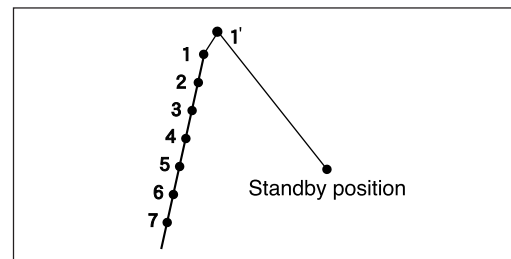

## 5 Saving

1. Specify the program number on the operation panel, then press **FD** switch for writing into the floppy disk.  
Refer to "Using the operation panel of the main body"(page 131) for detailed operation.

## 6 Ending program

1. Press **P**.

## Adding shunting point before the first stitch

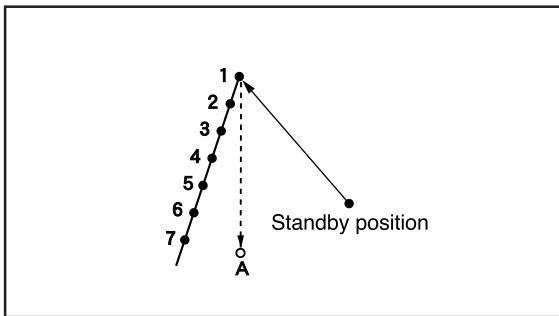

An shunting point is added before the sewing start position. The example in the left is used for explanation of setting shunting point A.

The shunting point is a provisional point provided for prevention of the work clamp interference with impediments on it when it moves directly from the standby position to the sewing start position.

### 1 Calling data

- Specify the program number on the operation panel, then press switch to read the data.  
Refer to "Using the operation panel of the main body"(page 128) for detailed operation.

### 2 Moving to position 1

- Press , then press .
- The needle moves to the sewing start position.

### 3 Programming a new point

- Press .
  - Move the needle with so that the needle point is at A of the pattern.  
Record the coordinates (values of and .
  - Press .
- A is programmed.
- Press .
  - Move the needle with to the opposite position of coordinates recorded in step 2, then press .



## 4 Deleting 1

1. Press **2**, then press **-**.  
The needle point moves to the first stitch, point A and the first stitch.
2. Press **C**.
3. Input the number of stitches to be deleted, then press **+**.  
The example is deleting 1 stitch. Press **1** **+**.
4. The needle point moves to A.

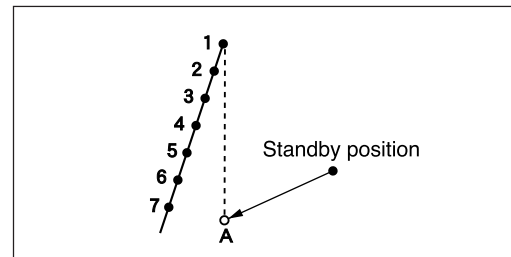

## 5 Saving

1. Specify the program number on the operation panel, then press **↓** switch for writing into the floppy disk.  
Refer to "Using the operation panel of the main body"(page 131) for detailed operation.

## 6 Ending program

1. Press **P**.

## Moving the shunting point

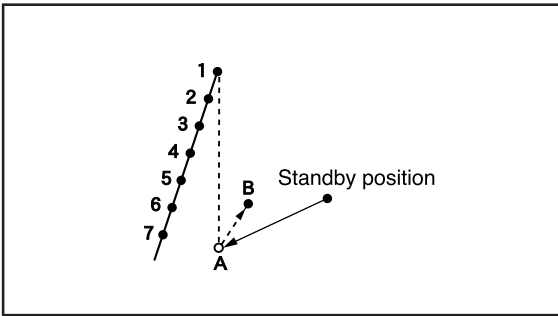



The position of the shunting point is moved. The example in the left is used for explanation of moving the shunting point from A to B.



### 1 Calling data

1. Specify the program number on the operation panel, then press  switch to read the data.  
Refer to "Using the operation panel of the main body"(page 128) for detailed operation.







### 2 Moving to position A

1. Press , then press .
- The needle moves to the shunting point.

### 3 Programming a new point

1. Press .
2. Move the needle with . Press  when the needle point is at B of the pattern.  
B is programmed.

### 4 Deleting 1

1. Press , then press .
- The needle point returns to A.
2. Press .
  3. Input the number of stitches to be deleted, then press .
- The example is deleting 1 stitch. Press  .

- The needle point moves to B.

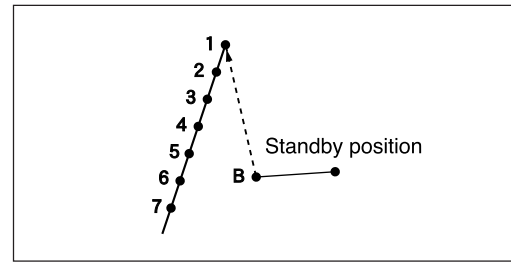

## 5 Saving

- Specify the program number on the operation panel, then press  switch for writing into the floppy disk.

Refer to "Using the operation panel of the main body"(page 131) for detailed operation.

## 6 Ending program

- Press .

### Deleting the shunting point

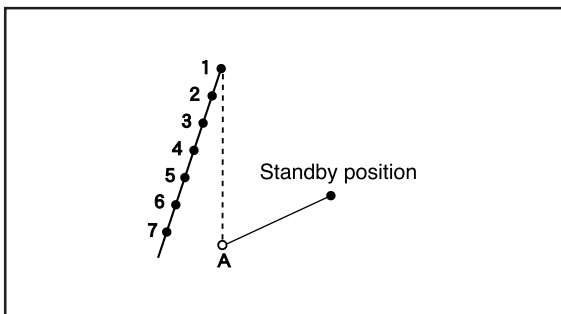



The shunting point is deleted. The example in the left is used for explanation of deleting A.

## 1 Calling data

- Specify the program number on the operation panel, then press  switch to read the data.

Refer to "Using the operation panel of the main body"(page 128) for detailed operation.

## 2 Moving to position A.

- Press  and press .
- The needle moves to the shunting point.

## 3 Deleting A

1. Press **C**.
2. Input the number of stitches to be deleted, then press **+**.  
The example is deleting 1 stitch. Press **1** **+**.
3. The needle point moves to 1.

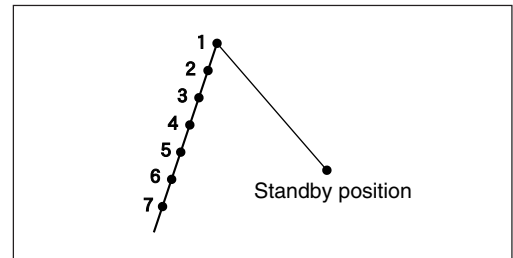

## 4 Saving

1. Specify the program number on the operation panel, then press **DISK** switch for writing into the floppy disk.

Refer to "Using the operation panel of the main body"(page 131) for detailed operation.

## 5 Ending program

1. Press **P**.

### Moving the entire pattern in parallel

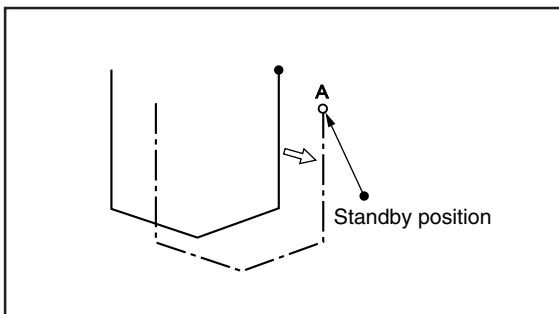

The entire program data is moved in parallel. The example in the left is used for explanation of moving the program data in parallel.

## 1 Calling data

1. Specify the program number on the operation panel, then press **DATA** switch to read the data.  
Refer to "Using the operation panel of the main body"(page 128) for detailed operation.



## 2 Moving in parallel

1. Move the needle with  $\Delta \nabla \triangleleft \triangleright$ . Press **L** when the needle point is at A of the pattern.

## 3 Saving

1. Specify the program number on the operation panel, then press  switch for writing into the floppy disk.

Refer to "Using the operation panel of the main body"(page 131) for detailed operation.

## 4 Ending program

1. Press **P**.

### Deleting a part of the program during programming

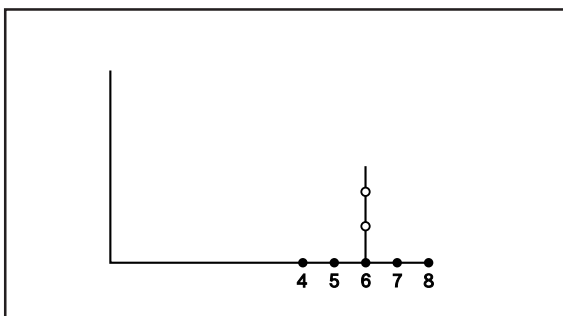

A program can be modified during programming. The example in the left is used for explanation of deleting 2 stitches at 8 and creating a new program.

1. Press **ESC** in the position 8 to display the screen on the right.
2. Input the number of stitches to be deleted, then press **-**.  
The example is deleting 2 stitches backward. Press **2** **-**.
3. The needle point moves to 6.

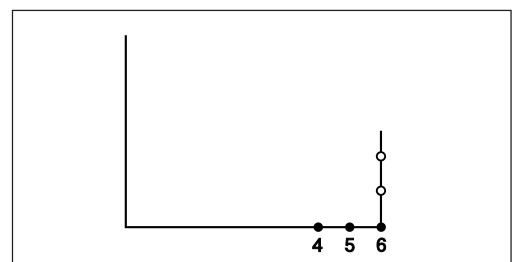







4. Continue programming.

# Programming

## Creating a line

Command to be used

    Input the stitch length in   .

Example	Pitch	Input
	0.5 mm	005
	6.0 mm	060

1. Select the sewing start position with , then press  .



2. Input the stitch length in 3 digits, then press  .



3. Move the needle with , then press  .



## Creating a curve

Command to be used

**0** **0** **0** **M**      Input the stitch length in **00** .

Example	Pitch	Input
	0.5mm	005
	3.0mm	030

**7** **8** **9** **L**      This command represents completing creation of a curve.

Increase the number of plotting points to create a smoother curve.  
One to 99 points are available for plotting.

1. Select the start point with **Δ▽◀▶**, then press **L** .



2. Input the stitch length in 3 digits, then press **M** .



Displays the number of the command input.

3. Move the needle with **Δ▽◀▶**, then press **L** in the position to be plotted.



4. Input **7** **8** **9** **L** at the end position of the needle.



Displays the number of the command input.

## Creating double stitch

### Command to be used

<input type="text" value="2"/> <input type="text"/> <input type="text"/> <input type="text"/> <input type="text"/>	<b>M</b>	Creating double stitch in the reverse direction to the sewing path. Input the width of double stitch in <input type="text"/> <input type="text"/> . Values 0.0 - 9.9 mm are available for the width.
Example	Width	Input
	1.5 mm	215
<input type="text"/> <input type="text"/> <input type="text"/> <input type="text"/>	<b>M</b>	Input the stitch length in <input type="text"/> <input type="text"/> <input type="text"/> .
<input type="text" value="7"/> <input type="text" value="8"/> <input type="text" value="9"/>	<b>L</b>	Input the point to be a corner. Carrying out double stitch on the left side to the sewing path.
<input type="text" value="1"/> <input type="text" value="1"/> <input type="text" value="1"/>	<b>E</b>	Starting double stitch calculations.

If sharp angles or fine curves are included in the pattern sheet, the desired double stitch may not be achieved.

1. Select the sewing start position with  $\Delta \nabla \triangleleft \triangleright$ , then press **L** .

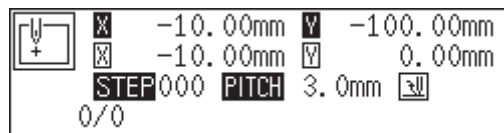

2. Determine the width, then input **M** .

To change the stitch length, input it after this procedure.



Displays the number of the command input.

3. Move the needle with  $\Delta \nabla \triangleleft \triangleright$  to select the second point, then press **L** .



4. Move the needle to the corner point, then input **L** .

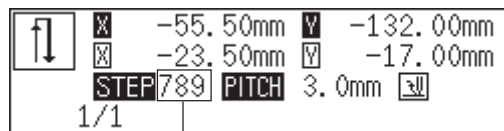

Displays the number of the command input.

- Repeat steps 3 and 4 and move the needle to the end point. Input **1 1 1 E**.

When the alarm sound is complete, the needle point moves to the end position.

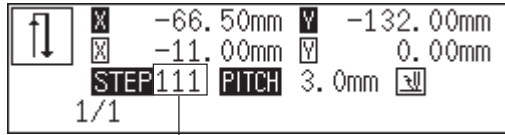

Displays the number of the command input.

## Creating feed data

Create (feed) data of the needle to move the needle from the current position to the next without dropping it.

Command to be used



Moving in parallel for the feed

- Move to the point immediately preceding the point to be fed.



- Press **F**.



- Determine the feed point with **Δ▽◀▶**, then press **L**.



## Creating tacking data

Command to be used



Create needle tacking data. Input stitch length in  .  
Values 0.1 to 1.0 mm are available for the stitch length.

Tacking width of the needle is set with the dial on the back of the top part of the machine. Values 1.0 to 3.5 mm are available for the tacking width.

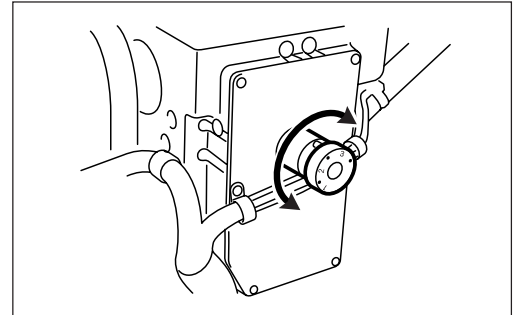

1. Determine the sewing start position with  $\Delta \nabla \triangleleft \triangleright$ , then press **L**.



2. Determine the stitch length, then input    **L**.

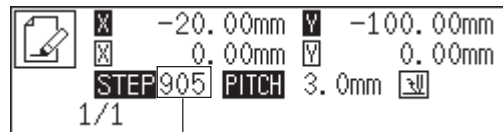

Displays the number of the command input.

3. Move the needle with  $\Delta \nabla \triangleleft \triangleright$ , then press **L**.



## Ending programming

When programming is completed, input an end code.

Command to be used

**1** **1** **1** **E**

Ending programming

1. When the data is created, input the end code.



Displays the number of the command input.

Data after the end code is input is deleted.



# Checking the program setting and setting attribute

Checking the program setting and setting attribute

The following items are displayed.

Current coordinate	
Distance from the previous position in the X and Y axial directions	
Stitch length	
End code	
Current needle position / Total stitch count	
Stitch data type	is displayed.
Needle tacking (*)	Needle tacking is set for each stitch.
Two step tension setting (*)	Two step tension output is set in the current needle position.
Two row switch (*)	The clamp is set inside when it is set to ON and is set outside when it is changed from ON to OFF.
Option output (*)	Whether option output is conducted or not is set.
Slow conversion (*)	Three successive stitches at low speed are set. Values 500 to 33500 rpm are available for the speed.
Feed data type	is displayed.
Option output (*)	Whether option output is conducted or not is set.

The cylinder operates when changing option output, two row switch, and two step tension setting.

The option output is connected to the following ports

Number of connector	P26(MN-OPT-OUT)
Number of common pin	5 or 6 (+24V)
Number of signal pin	1

Two row switch can be set only in one position in one program. The newly set point becomes valid if two row switch is already set in the program.

Attribute of items marked with \* are available for setting.

An example of stitch data is shown below.

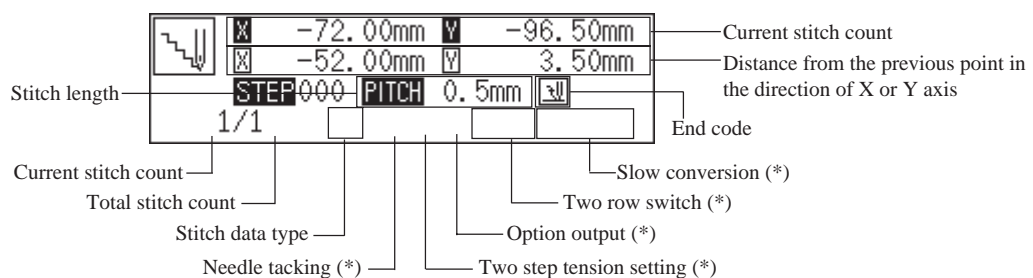



## Checking attributes

Attributes in the current needle position are displayed on the programmer screen.

The needle position can be moved as follows.

- \* Check each stitch.
- \* Check a series of stitches automatically.

### Checking each stitch

1. Press **+** to move forward, **-** to backward.

The needle steps by each stitch and the setting of the data is displayed.

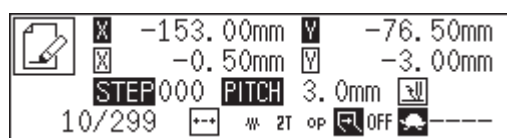

### Checking a series of stitches automatically

1. Input the stitch count to check.
2. Press **+** to move forward, **-** to backward.

The needle moves by the input count and the setting of the data is displayed.

Input "999" to check all stitches.



This screen is displayed while the needle is moving.

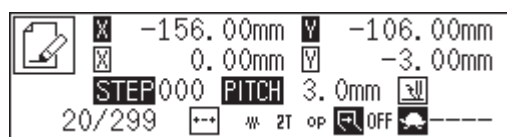

This screen is displayed after the needle has stopped.

## Setting needle tacking in a unit of one stitch

Command to be used

3	3	3	L	Setting needle tacking.
3	3	4	L	Canceling needle tacking.

1. Move to the desired needle position.  
Refer to page 112 on how to move the needle position.
2. Input the command of needle tacking.

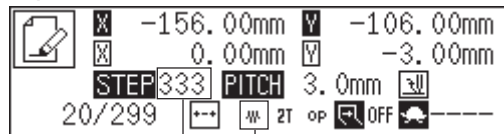

Indicates ○ when it is set.

Displays the number of the command input.

## Setting two step tension output

Command to be used

3	3	3	L	Setting two step tension output.
3	3	4	L	Canceling two step tension output.

1. Move to the desired needle position.  
Refer to page 112 on how to move the needle position.
2. Input the command of two step tension output.



Indicates ○ when it is set.

Displays the number of the command input.

## Setting the option output

This is set to flip/flop the option output.

Command to be used

7	7	3	<b>L</b>	Setting option output
7	7	4	<b>L</b>	Canceling option output setting

1. Move the needle to the desired position.
2. Input the command for option output.

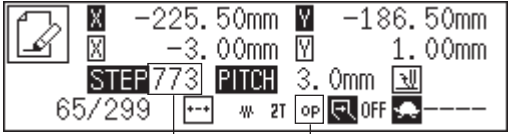

Indicates ○ when it is set.  
 Displays the number of the command input.

## Setting two row switch

Command to be used

8	1	0	<b>L</b>	Setting two row switch
8	1	1	<b>L</b>	Canceling two row switch

1. Move the needle to the desired position.
2. Input the command of two row switch.

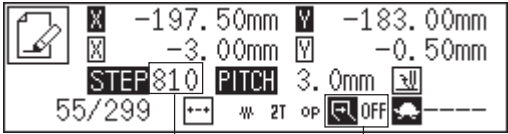

Indicates "ON" when it is set.  
 Displays the number of the command input.

## Low-speed sewing

Set to sew at low speed.

Command to be used

6 0 5 L	Sewing speed of successive three stitches becomes 500 rpm.
6 0 6 L	Canceling 6 0 5 L .
6 1 0 L	Sewing speed of successive three stitches becomes 1000 rpm.
6 1 1 L	Canceling 6 1 0 L .
6 1 5 L	Sewing speed of successive three stitches becomes 1500 rpm.
6 1 6 L	Canceling 6 1 5 L .
6 2 0 L	Sewing speed of successive three stitches becomes 2000 rpm.
6 2 1 L	Canceling 6 2 0 L .
6 2 5 L	Sewing speed of successive three stitches becomes 2500 rpm.
6 2 6 L	Canceling 6 2 5 L .
6 3 0 L	Sewing speed of successive three stitches becomes 3000 rpm.
6 3 1 L	Canceling 6 3 0 L .
6 3 5 L	Sewing speed of successive three stitches becomes 3500 rpm.
6 3 6 L	Canceling 6 3 5 L .

1. Move to the desired needle position for setting.
2. Select the type of low speed sewing, then input the command.

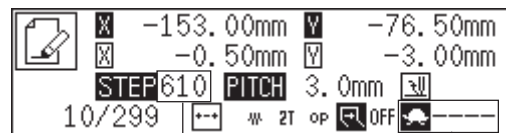

Displays the number of the command input.

Displays speed when it is set.

If multiple settings are required, input the stitch counts in 3 digits continuously and press **+**.

# Editing data

## Changing stitch length of the program

Command to be used

**1 1 1 M** Changing the stitch length of the program

This function is available only when the needle is at the standby position.

The pitch of the needle tacking data is not changed. The following settings of attributes become invalid when changing the pitch. Set them again after changing the pitch.

- \* Two step tension setting
- \* Two row switch
- \* Option output
- \* Slow conversion

1. Check to see that the needle is at in the standby position.

Press **R** if it is not at the standby position.

2. Input **1 1 1 M** .



Displays the number of the command input.

3. Input the stitch length in 3 digits, then press **L** .

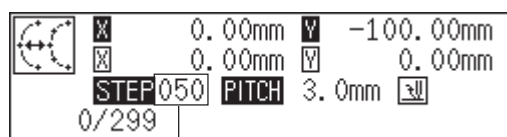

Stitch length

## Offset

### Command to be used

4	<input type="text"/>	<input type="text"/>	<input type="text"/>	<b>M</b>	Creating offset. Input the width of offset in <input type="text"/> <input type="text"/> . Values 1.0 - 9.9 mm are available for the width
	Example	Width		Input	
		1.5 mm		415	
5	<input type="text"/>	<input type="text"/>	<input type="text"/>	<b>M</b>	Offsetting the data to the right side of the sewing path. Input the width to be offset in <input type="text"/> <input type="text"/> .
<input type="text"/>	<input type="text"/>	<input type="text"/>	<input type="text"/>	<b>M</b>	Input the stitch length in <input type="text"/> <input type="text"/> <input type="text"/> .
<input type="text"/>	<input type="text"/>	<input type="text"/>	<input type="text"/>	<b>+</b>	Moving to <input type="text"/> <input type="text"/> <input type="text"/> stitches ahead.
<input type="text"/>	<input type="text"/>	<input type="text"/>	<input type="text"/>	<b>-</b>	Moving to <input type="text"/> <input type="text"/> <input type="text"/> stitches back.

It will automatically become the first point to be offset.

1. Move the needle to the first point to be offset.

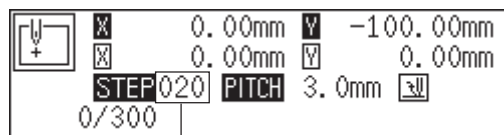

Stitch count to be moved

2. Determine the stitch width, then input **M** or **M** .  
To change the stitch length, input it after this procedure.

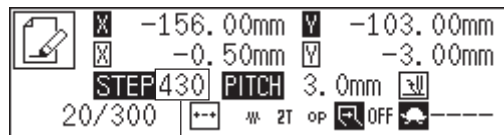

Displays the number of the command input.

3. Move to the last point to be offset.

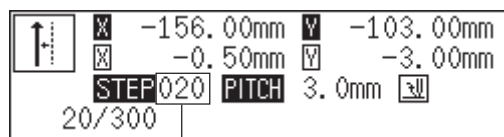

Stitch count to be moved

4. Press **L** twice.



## Rotating a pattern clockwise (counterclockwise)

Command to be used

<b>6</b> <b>6</b> <b>6</b> <b>M</b>	Rotating clockwise.
<b>6</b> <b>6</b> <b>7</b> <b>M</b>	Rotating counterclockwise.

This function is available only when the needle is at the home position.  
 Values of 1 - 359 degrees are available for input.  
 The reference point of rotation is the center of the external shape of the data.

1. Make sure that the needle is at the home position.  
 Press **R** if the needle is not at the home position.

2. Input **6 6 6 M** or **6 6 7 M**.



3. Input the angle in 3 digits, then press **L**.



## Resizing

Command to be used

<b>8 8 8 M</b>	Resizing a pattern in the X and Y directions
<b>0 0 0 F</b>	Used to input magnification in the X direction. Values 90 to 110 % are available for resizing.
<b>0 0 0 M</b>	Used to input magnification in the Y direction. Values 90 to 110 % are available for resizing.

This function is available only when the needle is at the home position.

The center point (reference point) of resizing is as follows.

X coordinate : Center of the outer shape of the data

Y coordinate : Uppermost position of the data

All the settings of attributes become invalid if the pattern is resized without changing the stitch length. Set the attributes after resizing the pattern.

1. Make sure that the needle is at the home position.

Press **R** if the needle is not at the home position.

2. Input **8 8 8 M** .



Displays the number of the command input.

3. Input the magnification in 3 digits in the X direction, then press **F** .

Magnification values of 0 - 400 are available for input.

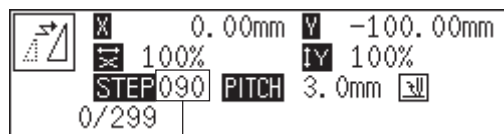

Displays the number of the magnification input.

4. Input the magnification in 3 digits in the Y direction, then press **M** .

Magnification values of 0 - 400 are available for input.

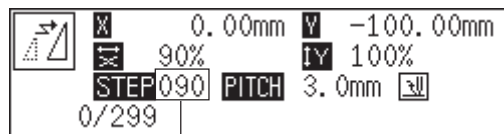

Displays the number of the magnification input.

5. Input the stitch length in 3 digits, then press **L** .

If the value is "000", the stitch count remains unchanged. The stitch length increases or decreases.

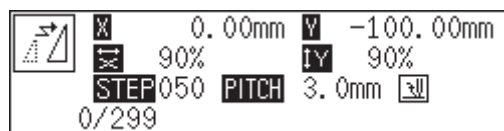



# Moving in parallel

Command to be used

**F** **7** **7** **7** **L** Moving data of the needle position after the current position in parallel by feeding

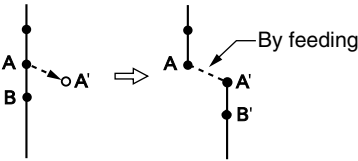

**L** **7** **7** **7** **L** Moving data of the needle position after the current position in parallel by stitching with the specified stitch length. Specify the stitch length in 3 digits before pressing ?.

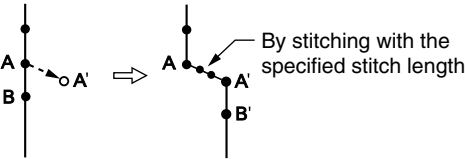

**7** **7** **7** **L** **L** Moving data of the needle position after the current position in parallel by stitching when the moving distance is 6.0 mm or less and by feeding when it is more than 6.0 mm.

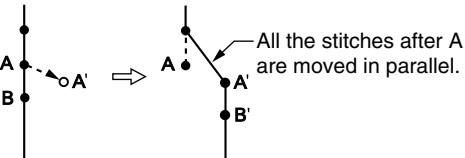

1. Move to the desired needle position.  
Refer to page 112 on how to move the needle position.

When **F** **7** **7** **7** **L**

2. Press **F**.
3. Determine the destination with **Δ****▽****◀****▶**, then press **7** **7** **7** **L**.

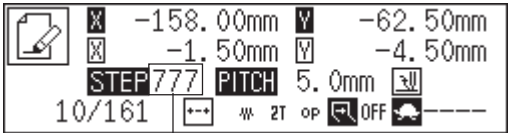

Displays the number of the command input.

When **L** **7** **7** **7** **L**

- 2. Press **L**.
- 3. Determine the destination with **Δ****▽****◀****▶**, then press **7** **7** **7** **L**.



Displays the number of the command input.

When **7** **7** **7** **L**

- 2. Press **7** **7** **7** **L**.

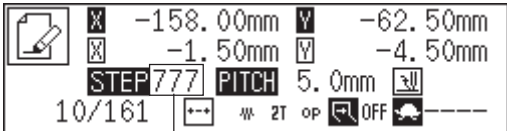

Displays the number of the command input.

- 3. Determine the destination with **Δ****▽****◀****▶**, then press **L**.

# Displaying image

A data image is displayed during programming or editing.

1. Press **J**.

Pattern image is displayed. Press **ESC** or **C** to return to the main menu.

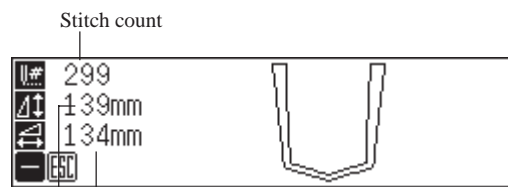

Press **-** to display the overall sewing area.

The data width is displayed in mm.

The data height is displayed in mm.



Press **+** to display the overall view of the data.

# Deleting data

Deletes the data during creating and displaying.

## Deleting a part of data

Command to be used

**C**    **+**

Deletes data after    stitches.

If this command is used at the sewing start position, the sewing start position is also deleted and the needle position after (number of stitches input + 1) stitches becomes the sewing start position.

**C**    **-**

Deletes data before    stitches.

If this command is used at the sewing end position, the end code is deleted.

1. Move the needle to the desired position.
2. Input the command.



Displays the number of the command input.

Input **C**    **+** to delete data after the current needle position.

Input **C**    **-** to delete data before the current needle position.

## Deleting program data

Command to be used

**2** **2** **2** **R**

Deleting all the data input

1. Press **2** **2** **2** **R** .



Displays the number of the command input.

An alarm sound is issued and input data is deleted.



# Chapter 4

## Reading / Writing Data



## Reading data

Reads data from a floppy disk.

Data can be read as follows.

- \* Using the help function



The data created with BAS-760 series can also be read. It is not available in the command mode.

- \* Using the operation panel of the main body

The data created with BAS-760 series can also be read. It is available both in the help mode and the command mode.

1. Select , then press .



2. Make sure that  is selected, then press .



3. Input the number of program with a numeric key.

If there is data,  appears.

If there is no data,  appears. If  appears, the data is from BAS-760 series.



## Checking the image display (go to 7 when not checking)

4. Press **▽** and select .



OFF is highlighted if selected.

5. Press **+** to turn ON.

Press **-** to turn OFF again.



6. Press **↵**.

An image is displayed. Press **ESC** or **C** to return to the submenu.

Displays the stitch count.

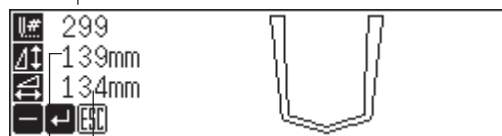

Press **-** to display the overall sewing area.

Displays the lateral length.

Displays the longitudinal length.

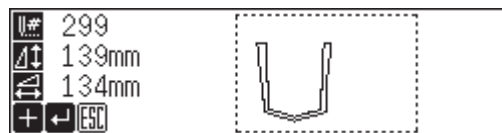

Press **+** to display the overall view of the sewing data.

7. Press **↵** to read the data.

To cancel reading, press **ESC**.



## Using the operation panel of the main body

1. Input the number of the program to be called up.

Select the digit with  and select the number with .

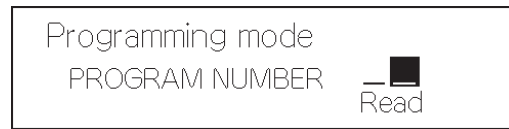

2. Press  switch.

The following screen is displayed while reading.

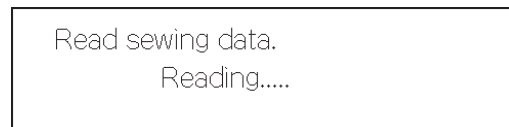

The following screen is displayed when reading is completed.

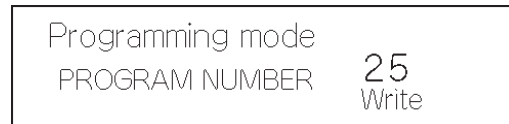



## Writing data

Writes data from the programmer to a floppy disk.

Be sure to use a formatted 2HD floppy disk. The floppy disk accompanying this product is already formatted.

Format a 2HD floppy disk according to the procedure described in page 132 if it is not formatted.

\* Data can be written as follows.

\* Using the help function

This is not available in the command mode.

\* Using the operation panel of the main body.

This is available both in the help mode and the command mode.

1. Select , then press .



2. Select , then press .



3. Input the number of program with a numeric key.

If there is data,  appears.

If there is no data,  appears. If  appears, the data is from BAS-760 series.



## Checking the image display (go to 7 when not checking)

4. Press **▽** and select .



OFF is highlighted if selected.

5. Press **+** to turn ON.  
Press **-** to turn OFF again.



6. Press **↵**.

An image is displayed. This is the image from data saved in a floppy disk, not the image currently in editing. Press **ESC** or **C** to return to the submenu.

Displays the stitch count.

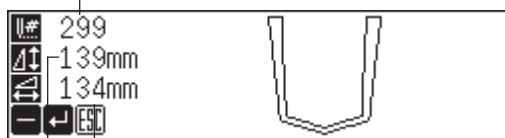

Press **-** to display the overall sewing area.

Displays the lateral length.

Displays the longitudinal length.







Press **+** to display the overall view of the sewing data.

7. Press **↵** to write the data.

To cancel writing, press **ESC**.

## Using the operation panel of the main body

1. Input the number of the program to be written.

Select the digit with   and select the number with  .

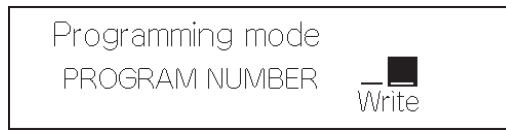

2. Press  switch.

The following screen is displayed while writing.



The following screen is displayed when writing is completed.

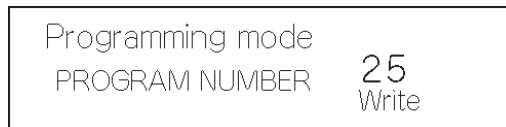

# Deleting data in a floppy disk

Deletes data saved in a floppy disk.

This operation cannot be available in command mode.

1. Select , then press .



2. Select , then press .



3. Input the number of program to be deleted with a numeric key.

If there is data,  appears.

If there is no data,  appears. If  appears, the data is from BAS-760 series.



## Checking the image display (go to 7 when not checking)

4. Press  and select .





OFF is highlighted if selected.

5. Press  to turn ON.

Press  to turn OFF again.



6. Press .

An image is displayed. This is the image from data saved in a floppy disk, not the image currently in editing. Press  or  to return to the submenu.

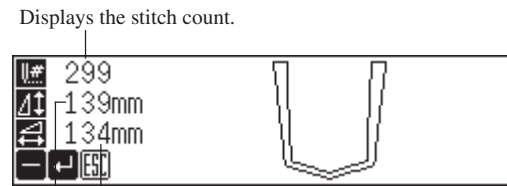

Press  to display the overall sewing area.

Displays the lateral length.

Displays the longitudinal length.



Press  to display the overall view of the sewing data.

7. Press .

To cancel deletion, press .



## Formatting a floppy disk

Formats a floppy disk for the programmer.

This operation cannot be available in command mode.

Formatting a floppy disk will erase all the data in it.

1. Select , then press  .



2. Select , then press  .



3. Press  for formatting and press  for not formatting.

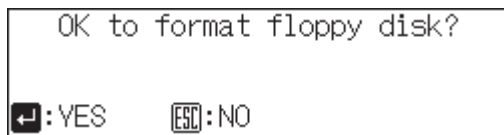

# Chapter 5

## Practical Programming Examples



# Programming examples

---

This chapter describes procedures to program the following frequently created patterns in each mode. The following two patterns are programmed and the standard retractable clamp is used.

## Example 1

---

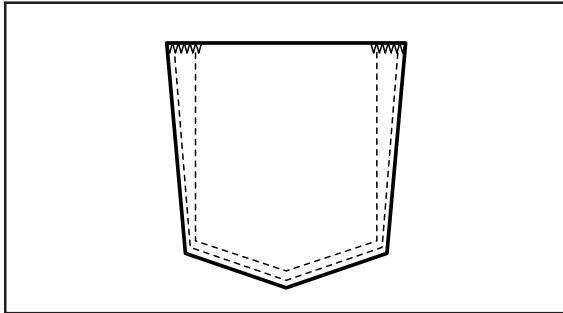

Only straight lines are programmed. Both ends of the pocket are reinforced with the needle tacking data.

## Example 2

---

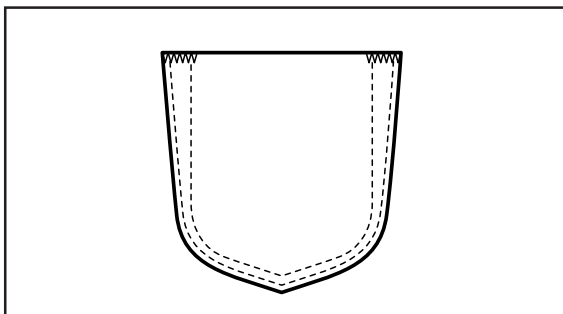

Straight lines and curves are programmed. Both ends of the pocket are reinforced with the needle tacking data.

# Example 1 (Help function)

## Programming procedure

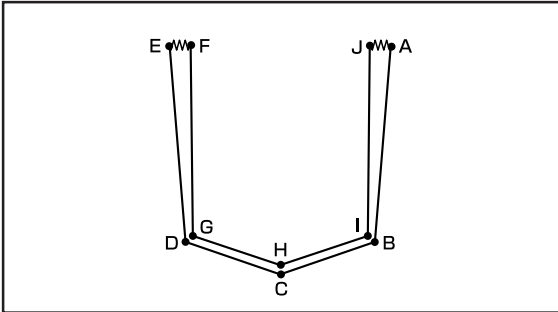

Functions to be used

- Straight line (page 58)
- Needle tacking (page 58)
- Checking the program setting and setting attribute (page 69)

## Flow of programming

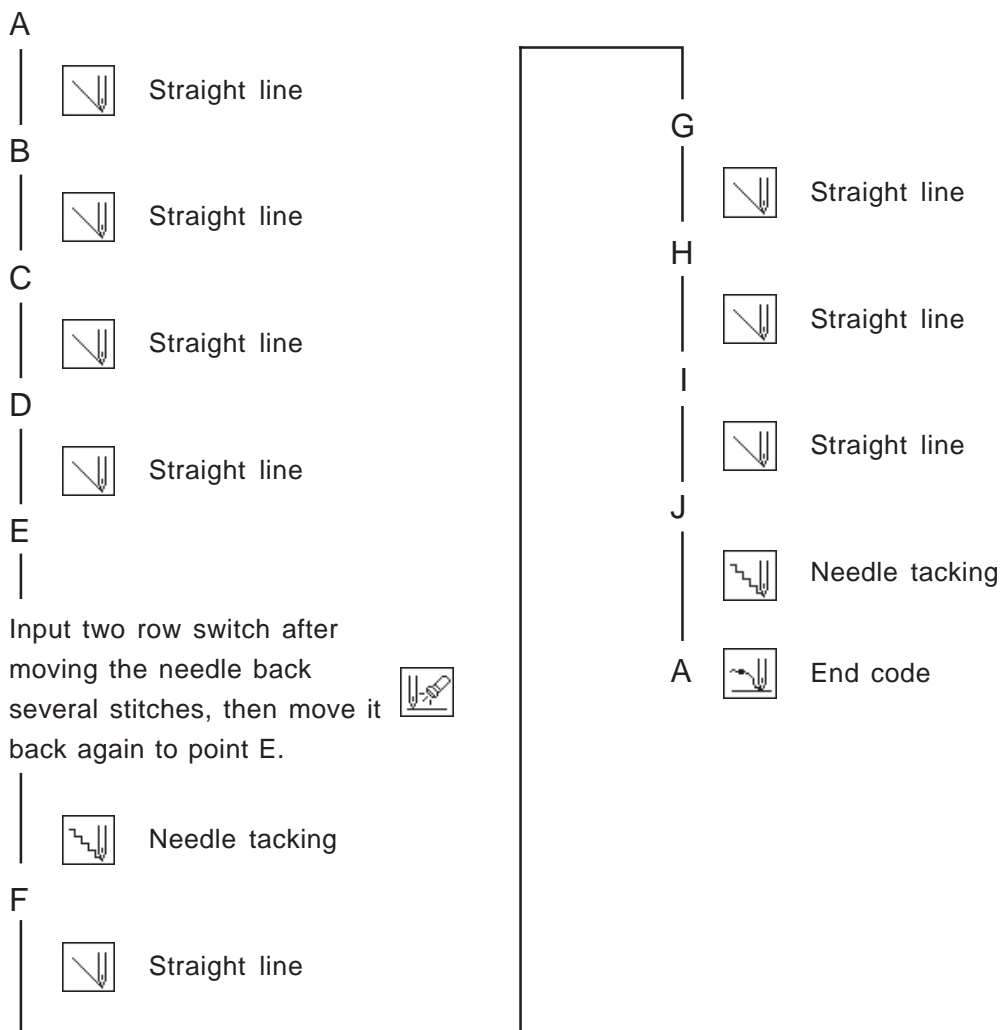

## Operating procedure

### 1 Programming

1. Press **P**.  
The work clamp comes down and the programmer screen is displayed.

2. Select  with **◀▶**, then press **↵**.



3. Move the needle with **Δ▽◀▶**. Press **↵** when the needle point is at point A of the pattern.  
The first stitch (point A) is programmed.



4. Select  with **Δ▽◀▶**, then press **↵**.

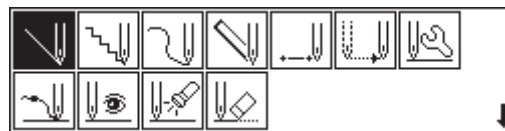

5. Input the stitch length, then press **↵**.  
3.0 mm is input in the example.  
Input 030 to make the stitch length to 3.0 mm.



6. Move the needle with **Δ▽◀▶**. Press **↵** when the needle point is at point B of the pattern.

7. Repeat step 6 and create the program to point E.

8. When point E is programmed, press **ESC** twice.

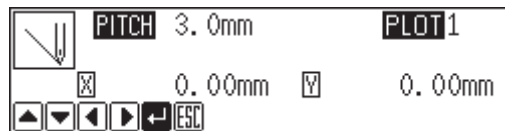

9. Select  icon with **Δ▽◀▶**, then press **↵**.

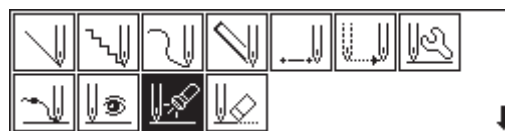

10. Input the number of stitches to return the needle to the position where two row switch is input, then press **-**.

5 is input in the example. The needle moves 5 stitches back.



11. Press .

The attribute setting screen appears.



12. Select  with , then press .

It is set to ON.



13. Press .



14. Input the number of stitches to proceed the needle to point E, then press .

5 is input in the example. The needle moves 5 stitches ahead.

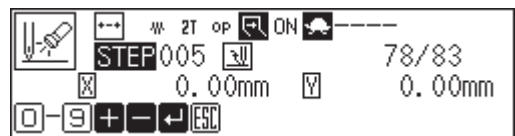

15. Press .

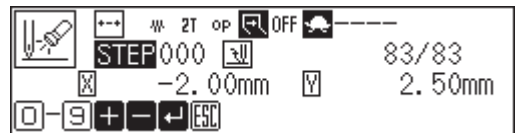

16. Select  with , then press .

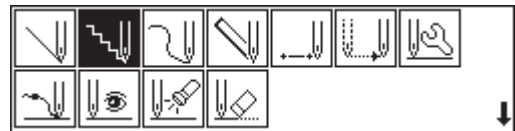

17. Input the stitch length of needle tacking, then press .

0.5 mm is input in the example.

Input 005 to make the stitch length to 0.5 mm.



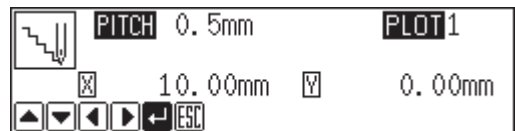

18. Move the needle with . Press  when the needle point is at point F of the pattern.



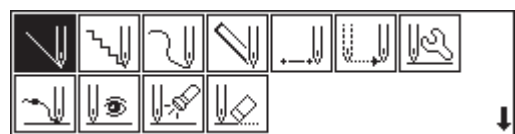

19. Press  twice.

20. Select  with , then press .



- Input the stitch length, then press .  
3.0 mm is input in the example.  
Input 030 to make the stitch length to 3.0 mm.



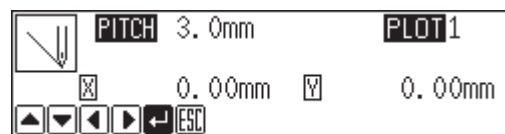

- Move the needle with . Press  when the needle point is at point G of the pattern.
- Repeat step 22 and create the program to point J.

- When point J is programmed, press  twice.

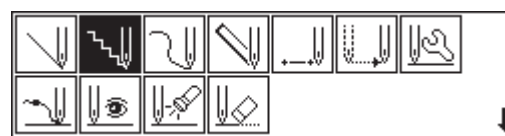

- Select  with , then press .



- Input the stitch length of needle tacking, then press .  
0.5 mm is input in the example.  
Input 005 to make the stitch length to 0.5 mm.



- Move the needle with . Press  when the needle point is at point A of the pattern.

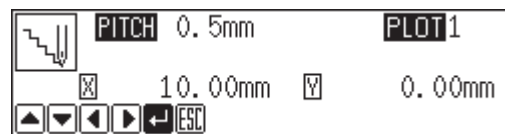

- Press  twice.

## Input the end code

- Select  with , then press .

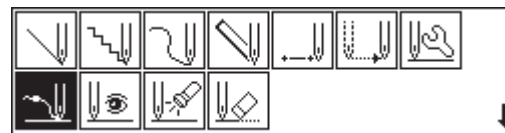

- Press .  
The needle goes back to the sewing start position and the retractable clamp is positioned outside.

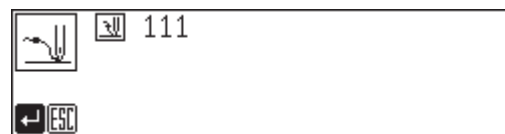

# Example 1 (Command function)

## Programming procedure

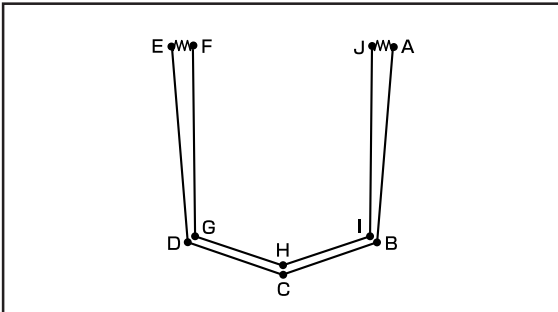

Functions to be used

- Straight line (page 105)
- Needle tacking (page 109)
- Checking attributes (page 112)
- Two row switch (page 114)

## Flow of programming

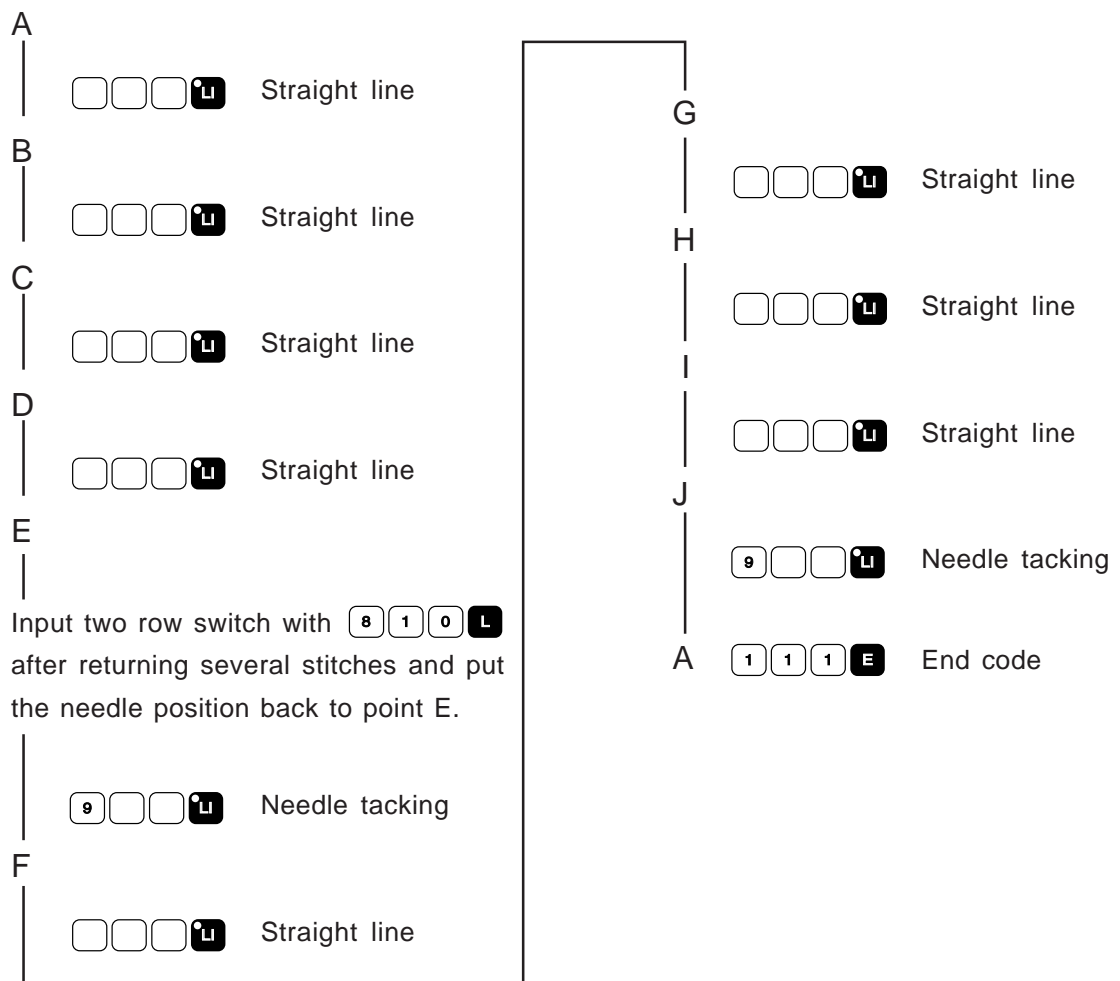

## Operating procedure

### 1 Programming

1. Press **P**.

The work clamp comes down and the programmer screen is displayed.

2. Move the needle with **Δ▽◀▶**. Press **L** when the needle point is at point A of the pattern.

The first stitch (point A) is programmed.

3. Input the stitch length.

3.0 mm is input in the example.

Input 030 to make the stitch length to 3.0 mm.



4. Press **L**.

5. Move the needle with **Δ▽◀▶**. Press **L** when the needle point is at point B of the pattern.

6. Repeat steps 4 and 5 and create the program to point E.

7. Input the number of stitches to return the needle to the position where two row switch is input, then press **-**.

5 is input in the example. The needle moves 5 stitches back.



8. Press **8 1 0**, then press **L**.

The screen to set the attributes appear and two row switch is set.



9. Input the number of stitches to proceed the needle to point E, then press **+**.

5 is input in the example. The needle moves 5 stitches ahead.



10. Press **9 0 0**, then press **L**.

**9 0 0** is a command for needle tacking. Input the stitch length in **0 0**. 0.5 mm is input in the example.



11. Move the needle with  $\Delta \nabla \triangleleft \triangleright$ . Press **L** when the needle point is at point F of the pattern
12. Press **U**.
13. Move the needle with  $\Delta \nabla \triangleleft \triangleright$ . Press **L** when the needle point is at point G of the pattern
14. Repeat steps 12 and 13 and create the program to point J.
15. Press **9**, then press **U**.  
**9** is a command for needle tacking. Input the stitch length in . 0.5 mm is input in the example.
16. Move the needle with  $\Delta \nabla \triangleleft \triangleright$ . Press **L** when the needle point is at point A of the pattern.



## 2 Input the end code

1. Press **1****1****1****E**.  
 The needle goes back to the sewing start position and the retractable clamp is positioned outside.



# Example 2 (Help function)

## Programming procedure

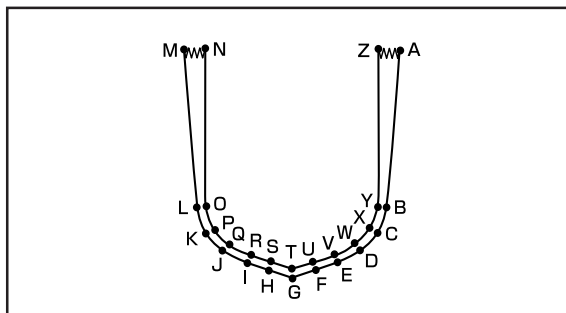

Functions to be used

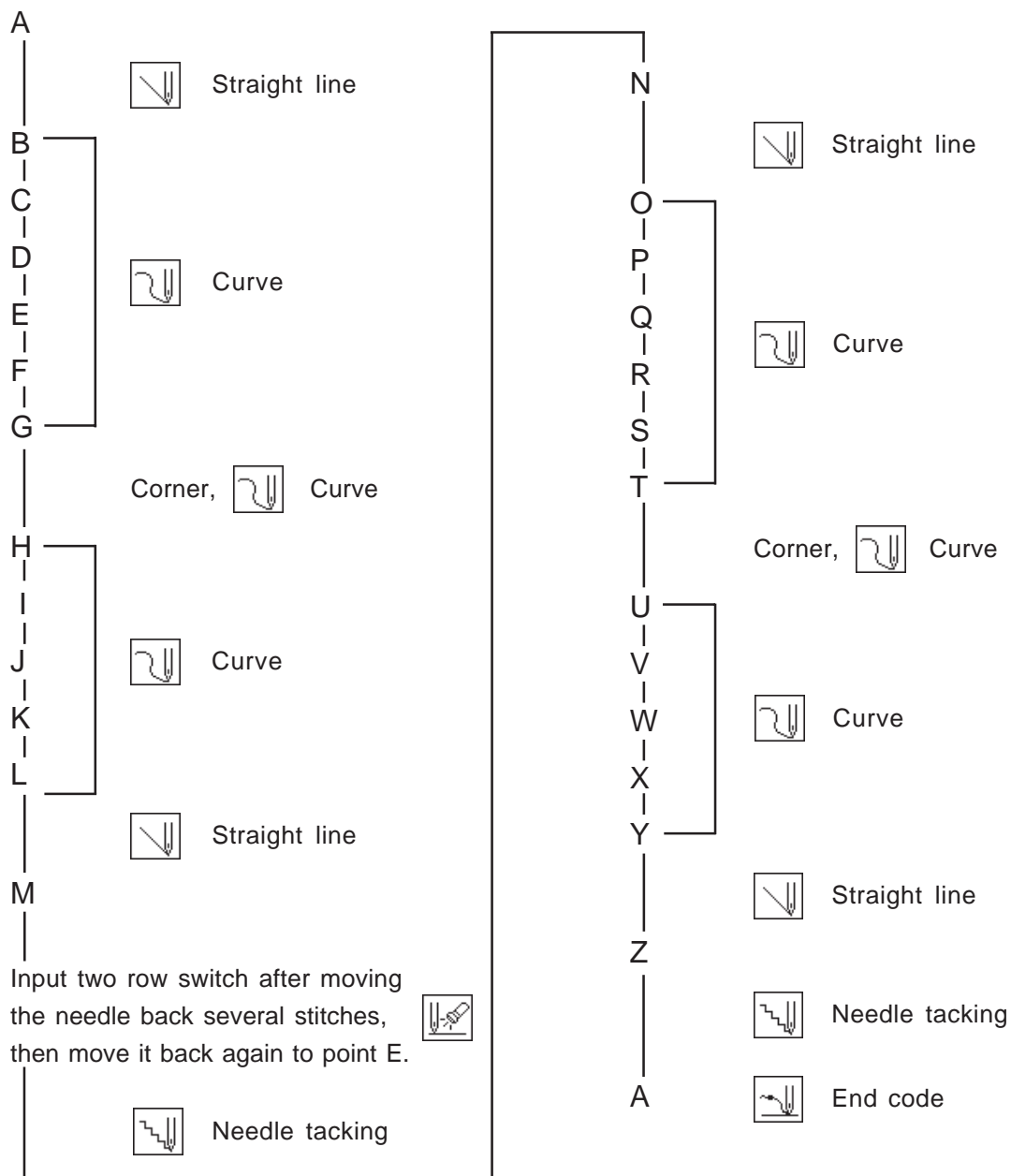

- Straight line (page 58)
- Curve (page 59)
- Needle tacking (page 58)
- Checking the program setting and setting attribute (page 69)

## Flow of programming



## Operating procedure

### 1 Programming

- Press **P**.  
The work clamp comes down and the programmer screen is displayed.
- Select  with **◀▶**, then press **↵**.
- Move the needle with **Δ▽◀▶**. Press **↵** when the needle point is at point A of the pattern.  
The first stitch (point A) is programmed.
- Select  with **Δ▽◀▶**, then press **↵**.
- Input the stitch length, then press **↵**.  
3.0 mm is input in the example.  
Input 030 to make the stitch length to 3.0 mm.
- Move the needle with **Δ▽◀▶**. Press **↵** when the needle point is at point B of the pattern.
- When point B is programmed, press **ESC** twice.
- Select  with **Δ▽◀▶**, then press **↵**.
- Input the stitch length, then press **↵**.  
3.0 mm is input in the example.  
Input 030 to make the stitch length to 3.0 mm.
- Move the needle with **Δ▽◀▶**. Press **↵** when the needle point is at point C of the pattern.

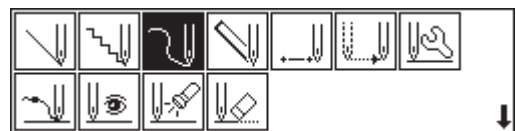
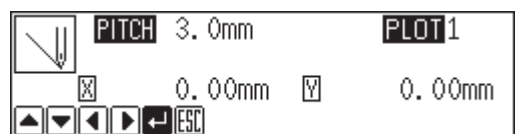
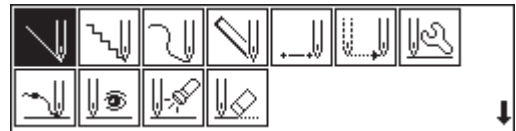
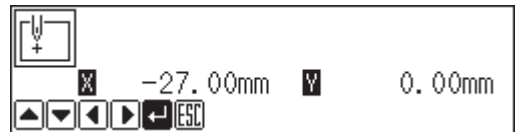

11. Repeat step 10 and create the program to point G.

12. When point G is programmed, press **↵** again.  
Point G is programmed to be a corner. To change the stitch length, press **ESC** to set it again.

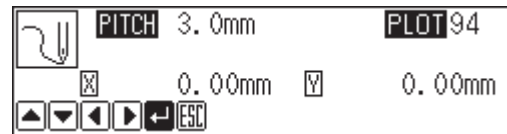

13. Create the program to point L.

14. When point L is programmed, press **↵** again.

15. Press **ESC** twice.

16. Select  with **Δ▽◀▶**, then press **↵**.

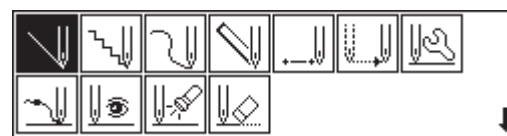

17. Press **↵**.



18. Move the needle with **Δ▽◀▶**. Press **↵** when the needle point is at point M of the pattern.

19. When point M is programmed, press **ESC** twice.

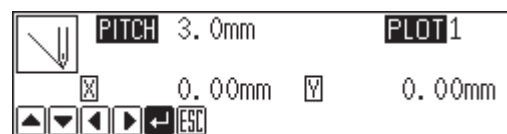

20. Select  with **Δ▽◀▶**, then press **↵**.

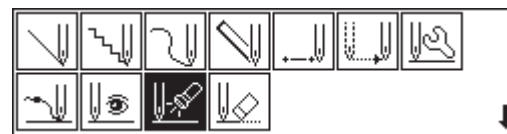

21. Input the number of stitches to return the needle to the position where two row switch is input, then press **[-]**.  
5 is input in the example. The needle moves 5 stitches back.



22. Press **↵**.  
The attribute setting screen appears.



23. Select  with  $\triangleleft \triangleright$ , then press  $\oplus$ .  
It is set to ON.



24. Press  $\downarrow$ .



25. Input the number of stitches to proceed the needle to point M, then press  $\oplus$ .  
5 is input in the example. The needle moves 5 stitches ahead.



26. Press  $\text{ESC}$ .



27. Select  with  $\triangle \nabla \triangleleft \triangleright$ , then press  $\oplus$ .

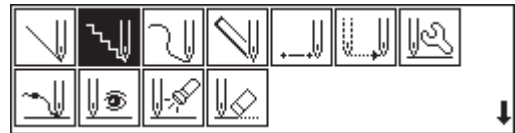

28. Input the stitch length of needle tacking, then press  $\downarrow$ .  
0.5 mm is input in the example.  
Input 005 to make the stitch length to 0.5 mm.



29. Move the needle with  $\triangle \nabla \triangleleft \triangleright$ . Press  $\downarrow$  when the needle point is at point N of the pattern.

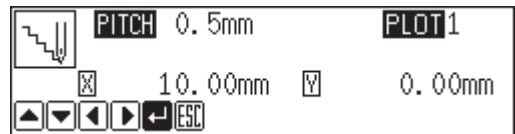

30. Press  $\text{ESC}$  twice.

31. Select  with  $\triangle \nabla \triangleleft \triangleright$ , then press  $\oplus$ .

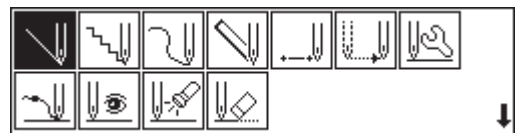

32. Input the stitch length, then press  $\downarrow$ .  
3.0 mm is input in the example.  
Input 030 to make the stitch length to 3.0 mm.



33. Move the needle with  $\Delta \nabla \triangleleft \triangleright$ . Press  $\downarrow$  when the needle point is at point O of the pattern.

34. When point O is programmed, press  $\text{ESC}$  twice.

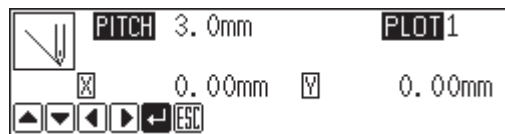

35. Select  $\downarrow$  with  $\Delta \nabla \triangleleft \triangleright$ , then press  $\downarrow$ .

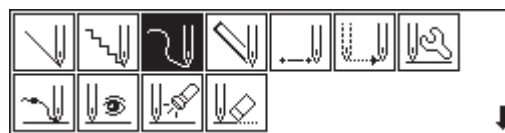

36. Press  $\downarrow$ .



37. Move the needle with  $\Delta \nabla \triangleleft \triangleright$ . Press  $\downarrow$  when the needle point is at point P of the pattern.

38. Repeat step 37 and create the program to point T.

39. When point T is programmed, press  $\downarrow$  again. Point T is programmed to be a corner. To change the stitch length, press  $\text{ESC}$  to set it again.

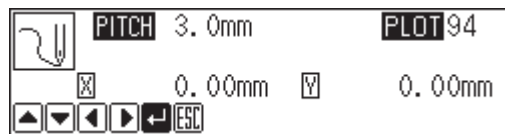

40. Create the program to point Y.

41. When point Y is programmed, press  $\downarrow$  again.

42. Press  $\text{ESC}$  twice.

43. Select  $\downarrow$  with  $\Delta \nabla \triangleleft \triangleright$ , then press  $\downarrow$ .

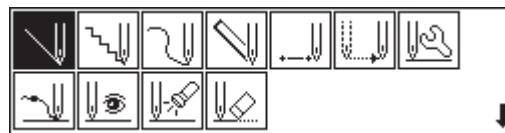

44. Press  $\downarrow$ .



45. Move the needle with  $\Delta \nabla \triangleleft \triangleright$ . Press  $\downarrow$  when the needle point is at point Z of the pattern.

46. When point Z is programmed, press **ESC** twice.

47. Select  with **Δ▽◀▶**, then press **↵**.

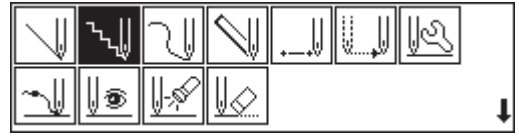

48. Input the stitch length of needle tacking, then press **↵**.

0.5 mm is input in the example.

Input 005 to make the stitch length to 0.5 mm.



49. Move the needle with **Δ▽◀▶**. Press **↵** when the needle point is at point A of the pattern

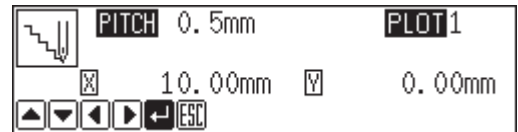

50. Press **ESC** twice.

## 2 Input the end code

1. Select  with **Δ▽◀▶**, then press **↵**.

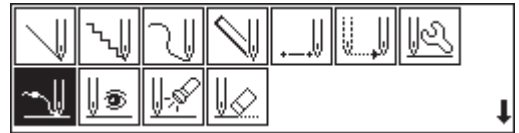

2. Press **↵**.

The needle goes back to the sewing start position and the retractable clamp is positioned outside.



# Example 2 (Command function)

## Programming procedure

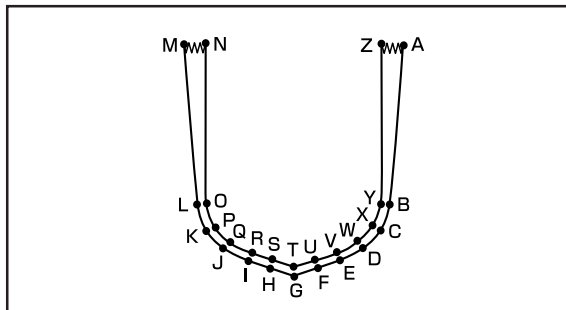

Functions to be used

- Straight line (page 105)
- Curve (page 106)
- Needle tacking (page 109)
- Checking attributes (page 112)
- Two row switch (page 114)

## Flow of programming

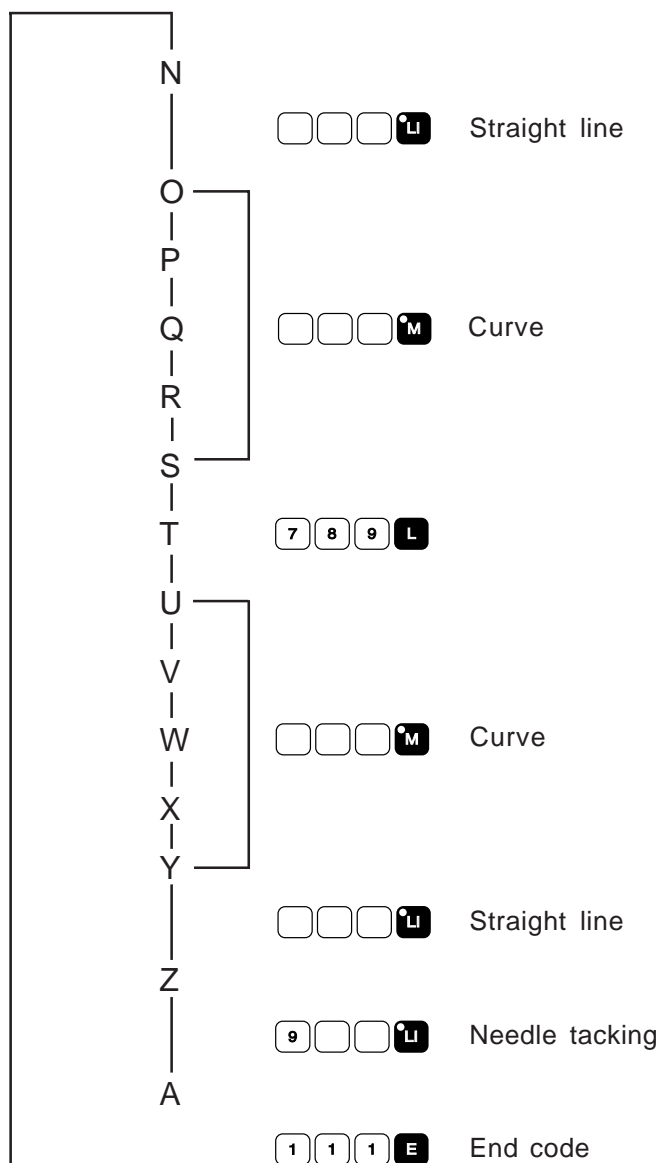
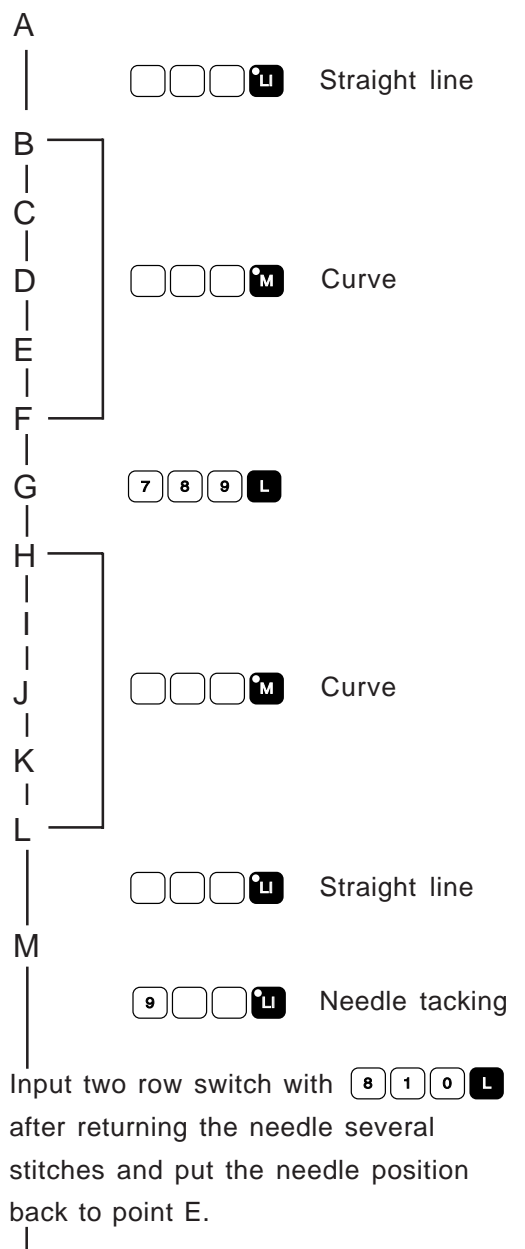

## Operating procedure

### 1 Programming

1. Press **P**.

The work clamp comes down and the programmer screen is displayed.

2. Move the needle with **Δ▽◀▶**. Press **L** when the needle point is at point A of the pattern.

The first stitch (point A) is programmed.

3. Input the stitch length.

3.0 mm is input in the example.



4. Press **U**.

To change the stitch length, specify it before pressing **U**.

5. Move the needle with **Δ▽◀▶**. Press **L** when the needle point is at point B of the pattern.

6. Press **M**.



7. Move the needle with **Δ▽◀▶**. Press **L** when the needle point is at point C of the pattern.



8. Repeat step 7 and create the program to point F.

9. Move the needle with **Δ▽◀▶**. Press **7 8 9 L** when the needle point is at point G of the pattern.

Point E is programmed to be a corner.

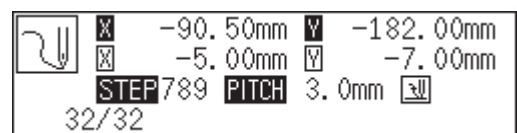

10. Press **M**.

11. Repeat steps 7, 8, and 9 and create the program to point L.



12. Press **L**.

13. Move the needle with **△▽◀▶**. Press **L** when the needle point is at point M of the pattern.

14. Input the number of stitches to return the needle to the position where two row switch is input, then press **-**.

5 is input in the example. The needle moves 5 stitches back.

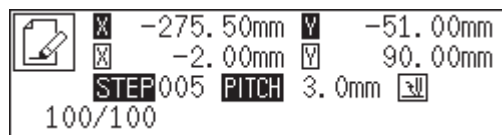

15. Press **8 1 0**, then press **L**.

The screen to set the attributes appear and two row switch is set.

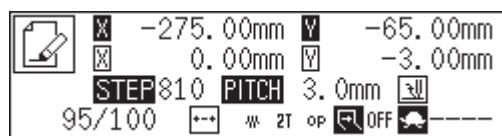

16. Input the number of stitches to proceed the needle to point M, then press **+**.

5 is input in the example. The needle moves 5 stitches ahead.

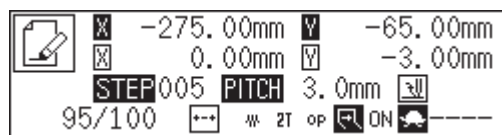

17. Press **9**, then press **L**.

**9** is a command for needle tacking. Input the stitch length in **0 0**. 0.5 mm is input in the example.



18. Move the work clamp with **△▽◀▶**. Press **L** when the needle point is at point N of the pattern.



19. Press **L**.

20. Move the needle with **△▽◀▶**. Press **L** when the needle point is at point O of the pattern.

21. Press **M**.



22. Move the needle with **△▽◀▶**. Press **L** when the needle point is at point P of the pattern.



23. Repeat step 22 and create the program to point S.

24. Move the needle with  $\Delta \nabla \triangleleft \triangleright$ . Press  $\boxed{7} \boxed{8} \boxed{9} \mathbf{L}$  when the needle point is at point T of the pattern.

Point N is programmed to be a corner.



25. Press  $\mathbf{M}$ .

26. Repeat step 22 and create the program to point Y.

27. Press  $\mathbf{U}$ .

28. Move the needle with  $\Delta \nabla \triangleleft \triangleright$ . Press  $\mathbf{L}$  when the needle point is at point Z of the pattern.

29. Press  $\boxed{9} \boxed{\phantom{0}} \boxed{\phantom{0}}$ , then press  $\mathbf{U}$ .  
 $\boxed{9} \boxed{\phantom{0}} \boxed{\phantom{0}}$  is a command for needle tacking. Input the stitch length in  $\boxed{\phantom{0}} \boxed{\phantom{0}}$ . 0.5 mm is input in the example.



30. Move the needle with  $\Delta \nabla \triangleleft \triangleright$ . Press  $\mathbf{L}$  when the needle point is at point A of the pattern.

## 2 Input the end code

1. Press  $\boxed{1} \boxed{1} \boxed{1} \mathbf{E}$ .

The needle goes back to the sewing start position and the retractable clamp is positioned outside.

**brother**<sup>®</sup>

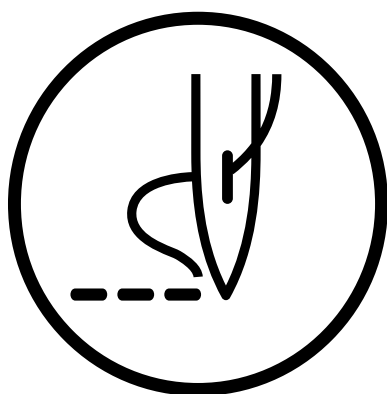

INSTRUCTION MANUAL

**BROTHER INDUSTRIES,LTD. NAGOYA,JAPAN**

Printed in Japan

151-761  
S93761-012  
1999. 1. B (1)