

DT4-B266

Flat bed double chain stitcher
with thread trimmer

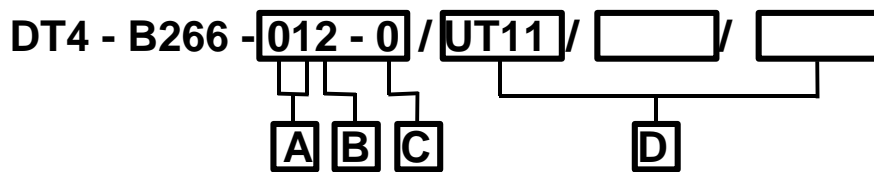

Specifications





| A | Feed type |
|----|-------------------|
| 01 | Uniform feed |
| 0D | Differential feed |





| B | Specifications |
|---|-------------------------------------|
| 2 | Standard gauge for medium materials |

| C | No. of needles / Needle gauge |
|---|-------------------------------|
| 0 | Single needle |

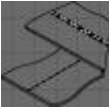
| D | | | | |
|------------|-------------------------|------------------------------|--------------------------|-------------------------------|
| Device No. | Device | | | |
| | Solenoid thread trimmer | Solenoid presser foot lifter | Pneumatic thread trimmer | Pneumatic presser foot lifter |
| UT11 | ○ | - | - | - |
| UT13 | ○ | ○ | - | - |
| UT21 | - | - | ○ | - |
| UT23 | - | - | ○ | ○ |

Specifications

| Sub-class | | Application | Stitch pattern |  No. of needle |  No. of thread |  Needle gauge (mm) |
|---------------|--------|---|--|---|---|---|
| Single needle | -012-0 | Plain stitching Medium materials (For general sewing of medium materials such as the side of slacks.) |  | 1 | 2 | - |
| | -0D2-0 | Plain stitching Medium materials (For general sewing of stretch materials such as knitted wear.) | | 1 | 2 | - |

| Feed method |  Max. stitch length (mm) |  Differential feed ratio |  Height of presser foot (mm) |  Needle type (UY128GAS) |  Max. sewing speed (rpm) |
|-------------------|---|---|---|--|---|
| Lower feed | 3.6 | - | - | SCHMETS #80- #120 ORGAN #12- #19 | 6,500 |
| Differential feed | 3.6 | 0.7 – 1.6 | 7 | SCHMETS #80- #120 ORGAN #12- #19 | 6,000 |

Optional parts

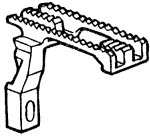
| | | | | |
|---|--|--|------------|-------|
|  | | Feeding presser foot (For preventing seam slippage) | S40548-301 | 012-0 |
|  | | Feed dog (For thin materials) | S40564-001 | |

Optional device

Thread wiper set

Solenoid type

| Part name | Part code | Q' ty |
|---------------------|------------|-------|
| Thread wiper set, B | S44920-001 | 1 |

Air type

| Part name | Part code | Q' ty |
|------------------|------------|-------|
| Thread wiper set | S28896-001 | 1 |

Presser foot lifter set

Solenoid type

| Part name | Part code | Q' ty |
|--------------------------------------|------------|-------|
| Solenoid presser foot lifter set (A) | 183795-401 | 1 |

* With the knee switch

Solenoid type

| Part name | Part code | Q' ty |
|--------------------------------------|------------|-------|
| Solenoid presser foot lifter set (B) | 183796-401 | 1 |

* Without the knee switch

Air type

| Part name | Part code | Q' ty |
|-----------------------------------|------------|-------|
| Pneumatic presser foot lifter set | S28904-001 | 1 |

* Without the knee switch

Thread trimmer set

Solenoid type

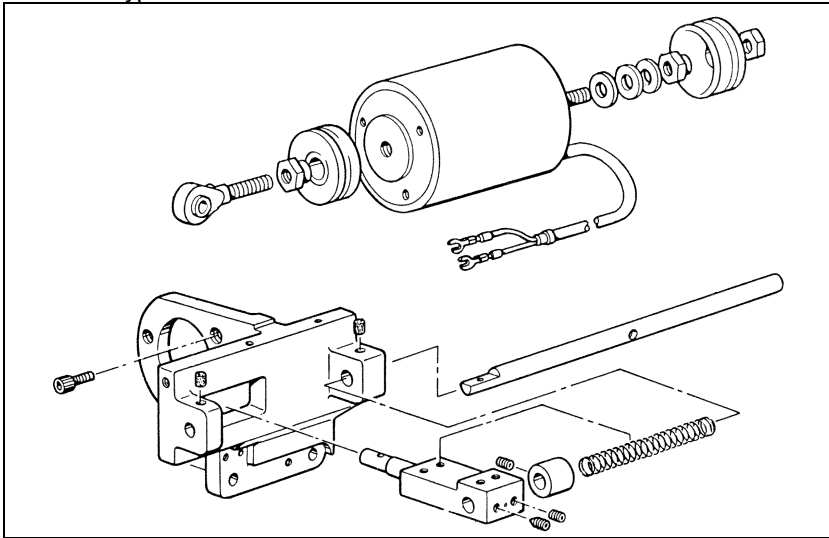

| Part name | Part code | Q' ty |
|-----------------------------|------------|-------|
| Solenoid thread trimmer set | S28906-001 | 1 |



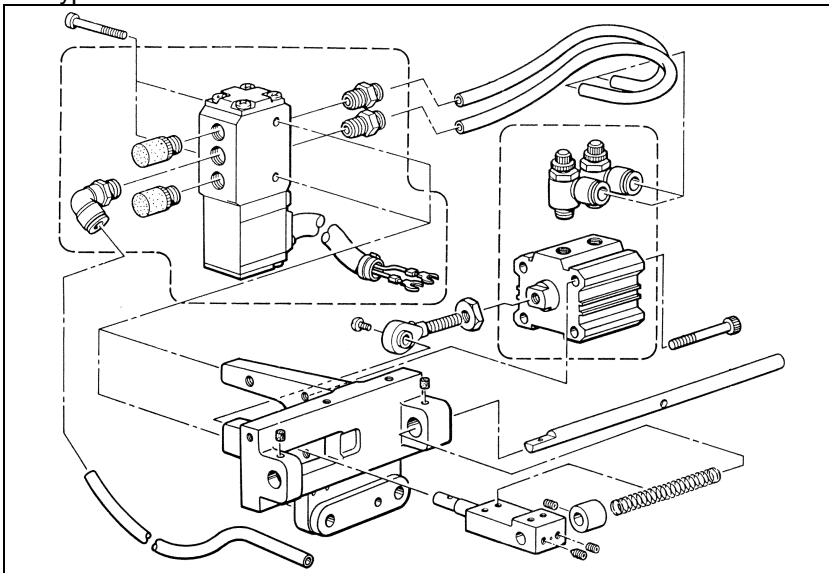

Air type

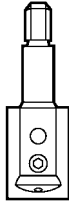
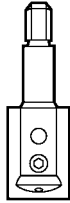
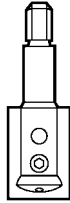
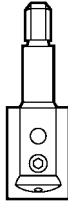
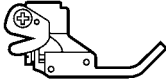
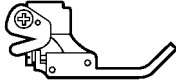
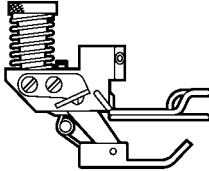
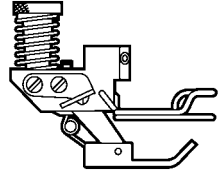

| Part name | Part code | Q' ty |
|------------------------------|------------|-------|
| Pneumatic thread trimmer set | S28908-001 | 1 |

GAUGE PARTS LIST

[Model DT4-B266]

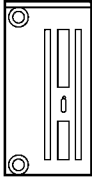
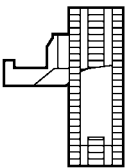
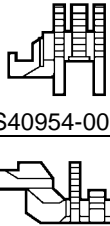
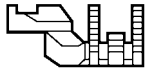
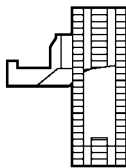
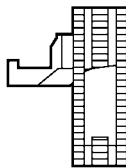
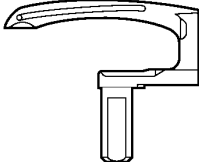
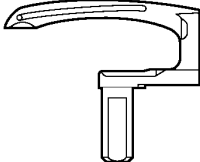
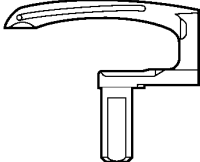
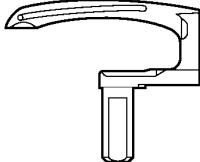
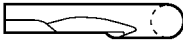
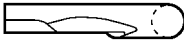
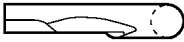
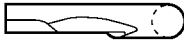
| Specifications | 012-0 | 0D2-0 | for 012-0 | for 012-0 |
|--------------------------|---|--|--|---|
| Label | S28933-003 | S28933-006 | Option | Option |
| Application | Plain stitching | Plain stitching | Plain stitching (Thin W / feeding presser foot) | Plain stitching (Medium thick W / feeding presser foot) |
| No. of needles | 1 | 1 | 1 | 1 |
| Needle spacing (mm) | - | - | - | - |
| Needle clamp assembly |  S17480-201 |  S17480-201 |  S17480-201 |  S17480-201 |
| Presser foot assembly |  S40541-101 |  S40952-101 |  S40548-301 |  S40548-301 |
| Needle plate |  S40538-001 |  S40538-001 |  S40538-001 |  S40538-001 |
| Feed dog |  S40565-001 |  S40954-001  S40955-001 |  S40564-001 |  S40565-001 |
| Looper |  S40569-001 |  S40569-001 |  S40569-001 |  S40569-001 |
| Needle guard |  S08756-001 |  S08756-001 |  S08756-001 |  S08756-001 |