

DT4-B266

Flat bed double chain stitcher
with thread trimmer

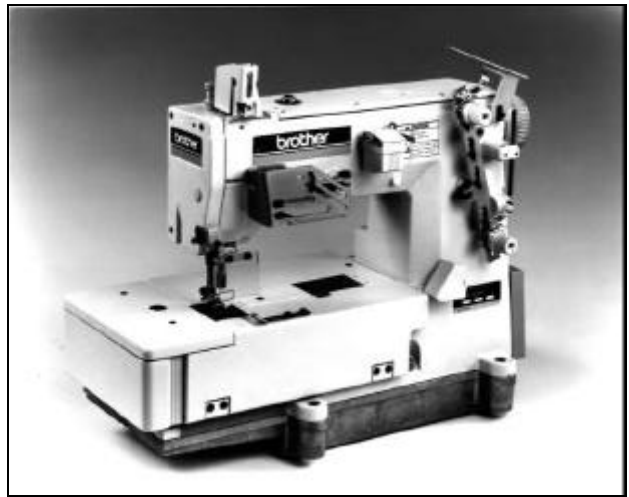

Specifications

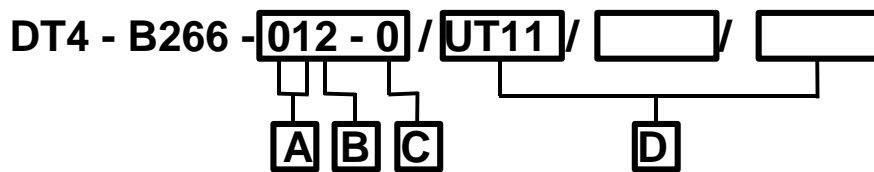



A	Feed type
01	Uniform feed
0D	Differential feed





B	Specifications
2	Standard gauge for medium materials

C	No. of needles / Needle gauge
0	Single needle

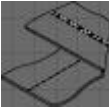
D				
Device No.	Device			
	Solenoid thread trimmer	Solenoid presser foot lifter	Pneumatic thread trimmer	Pneumatic presser foot lifter
UT11	○	-	-	-
UT13	○	○	-	-
UT21	-	-	○	-
UT23	-	-	○	○

Specifications

Sub-class		Application	Stitch pattern	 No. of needle	 No. of thread	 Needle gauge (mm)
Single needle	-012-0	Plain stitching Medium materials (For general sewing of medium materials such as the side of slacks.)		1	2	-
	-0D2-0	Plain stitching Medium materials (For general sewing of stretch materials such as knitted wear.)		1	2	-

Feed method	 Max. stitch length (mm)	 Differential feed ratio	 Height of presser foot (mm)	 Needle type (UY128GAS)	 Max. sewing speed (rpm)
Lower feed	3.6	-	-	SCHMETS #80- #120 ORGAN #12- #19	6,500
Differential feed	3.6	0.7 – 1.6	7	SCHMETS #80- #120 ORGAN #12- #19	6,000

Optional parts

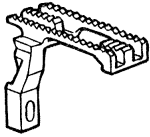
		Feeding presser foot (For preventing seam slippage)	S40548-301	012-0
		Feed dog (For thin materials)	S40564-001	

Optional device

Thread wiper set

Solenoid type

Part name	Part code	Q' ty
Thread wiper set, B	S44920-001	1

Air type

Part name	Part code	Q' ty
Thread wiper set	S28896-001	1

Presser foot lifter set

Solenoid type

Part name	Part code	Q' ty
Solenoid presser foot lifter set (A)	183795-401	1

* With the knee switch

Solenoid type

Part name	Part code	Q' ty
Solenoid presser foot lifter set (B)	183796-401	1

* Without the knee switch

Air type

Part name	Part code	Q' ty
Pneumatic presser foot lifter set	S28904-001	1

* Without the knee switch

Thread trimmer set

Solenoid type

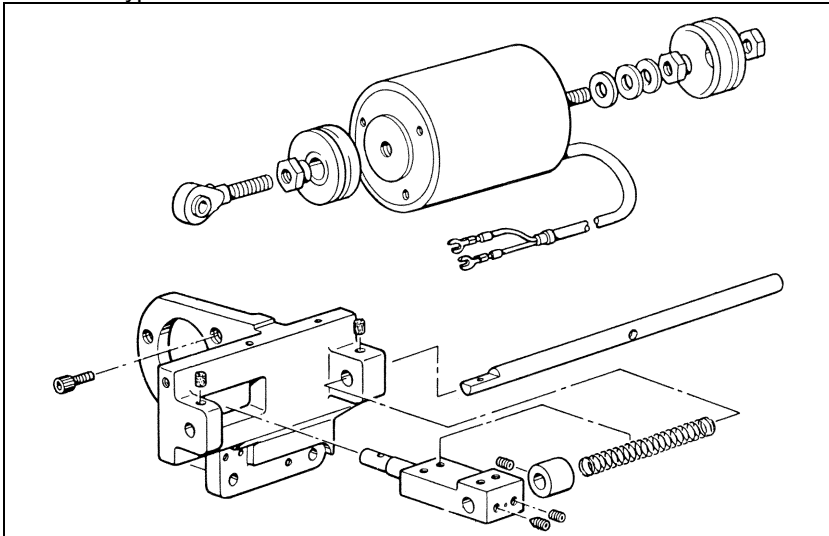

Part name	Part code	Q' ty
Solenoid thread trimmer set	S28906-001	1

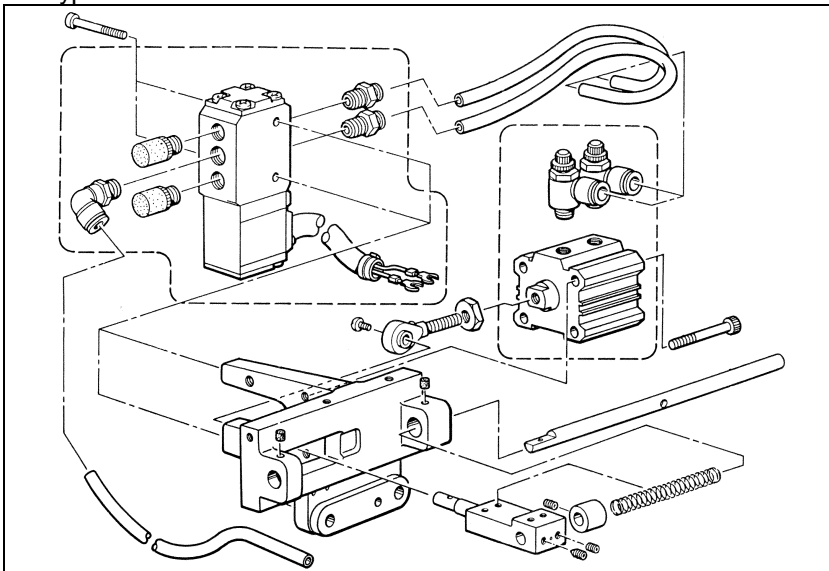

Air type



Part name	Part code	Q' ty
Pneumatic thread trimmer set	S28908-001	1

GAUGE PARTS LIST

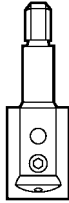
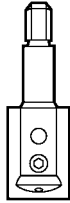
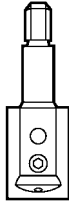
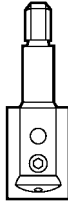
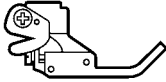
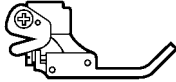
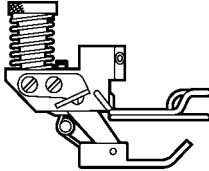
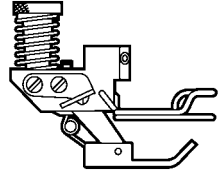
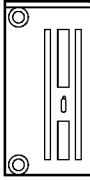
[Model DT4-B266]

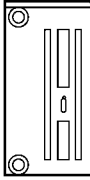
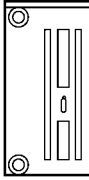
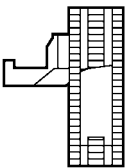
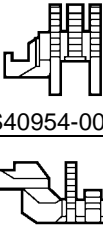
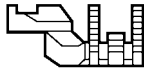
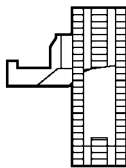
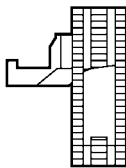
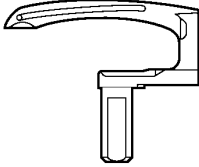
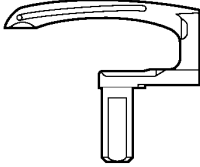
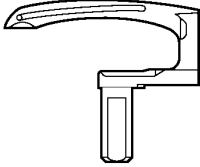
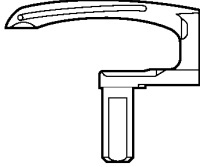
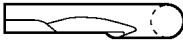
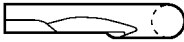
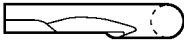
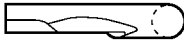
Specifications	012-0	0D2-0	for 012-0	for 012-0
Label	S28933-003	S28933-006	Option	Option
Application	Plain stitching	Plain stitching	Plain stitching (Thin W / feeding presser foot)	Plain stitching (Medium thick W / feeding presser foot)
No. of needles	1	1	1	1
Needle spacing (mm)	-	-	-	-
Needle clamp assembly	 S17480-201	 S17480-201	 S17480-201	 S17480-201
Presser foot assembly	 S40541-101	 S40952-101	 S40548-301	 S40548-301
Needle plate	 S40538-001	 S40538-001	 S40538-001	 S40538-001
Feed dog	 S40565-001	 S40954-001  S40955-001	 S40564-001	 S40565-001
Looper	 S40569-001	 S40569-001	 S40569-001	 S40569-001
Needle guard	 S08756-001	 S08756-001	 S08756-001	 S08756-001