

RH-981A

Electronic Eyelet Button Holer

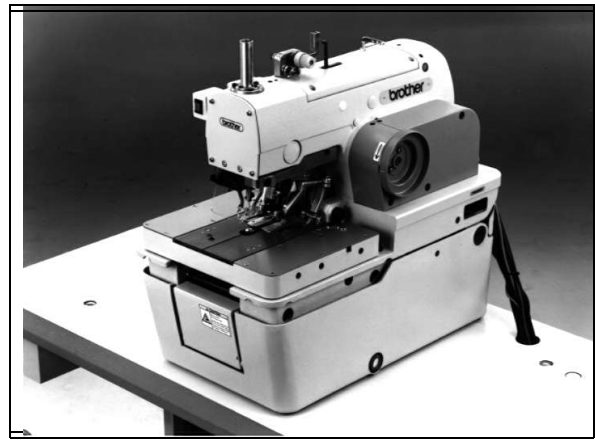

RH-981A-□□

	Upper thread trimmer	Lower thread trimmer		Fly indexer	Upper gimp guide	Special label cutting device
		Long type	Short type			
-00	○	-	-	-	Option	Option
-01	○	○	-	-	Option	Option
-02	○	-	○	Option	Option	-
-52	○	-	○	○	Option (L1-L4)	-

*-02 and -52 specifications are further divided into L1 – L7 specifications in accordance with the stitch length. Please be sure to specify the stitch length when ordering.

Specifications

Specification	-00	-01	-02 & -52
Application	Men's and ladies' clothes		Jeans and work clothes
Sewing speed	1,000 – 2,200 rpm (100-rpm steps)		
Stitch length	5 – 50 mm	5 – 38 mm	L1: 14 - 18 mm L5: 28 - 32 mm L2: 18 - 22 mm L6: 32 - 36 mm L3: 22 - 26 mm L7: 36 - 40 mm L4: 26 - 30 mm
Stitch pitch	0.5 – 2.0 mm		
Stitch width	1.5 – 3.2 mm		
Tacking length	0 – 20 mm		
Work clamp height	12 mm		16 mm
Starting method	Dual switch (cloth presser switch and start switch) or single switch		
Feed method	Intermittent feed by three pulse motors (X, Y, θ)		
Needle	DO × 558 Nm 80 – Nm 120 (Schumetz)		
Safety equipment	Built-in emergency stop function and automatic stopping device which stops the machine when the safety circuit is activated.		
Motor	Inverter-type induction motor		
Air pressure	Main regulator: 0.5 Mpa Knife pressure regulator: 0.3 Mpa		
Air consumption	43.2 l / min (8 cycle / min)		
Noise level	85 dB at max. speed of 2,200 rpm, measured according to ISO 10821		
Dimensions	1,200 mm (W) × 590 mm (D) × 1,120 mm (H)		
Work table legs	T-shaped height-adjustable type		
Power supply	Single-phase 110, 220, 230, 240 V Three phase 220, 380, 415 V Max. electric power consumption: 1kVA		
Weight	163.5 kg		

Replacement parts list for specification changes

The sewing machine can be changed to any one of L1 to L7 for -02 and -52 specifications by replacing the specified parts with the appropriate parts given below.

-02 specifications

Specifications (buttonhole length)	Replacement parts set	Plate R assembly Plate L assembly	Hammer	Specification harness
L1 (14 - 18mm)	S44238-001	S38576-301 S38577-201	S37702-001 (S12) S37704-001 (S16)	S43337-000
L2 (18 - 22mm)	S44239-001	S38578-301 S38579-201	S37704-001 (S16) S37706-001 (S20)	S43338-000
L3 (22 - 26mm)	S44240-001	S38580-301 S38581-201	S37706-001 (S20) S37708-001 (S24)	S43339-000
L4 (26 - 30mm)	S44271-001	S38582-301 S38583-201	S37708-001 (S24) S42053-001 (S28)	S43340-000
L5 (28 - 32mm)	S44272-001	S41470-101 S41471-101	S37197-001 (26) S37199-001 (30)	S43341-000
L6 (32 - 36mm)	S44273-001	S41472-101 S41473-101	S37199-001 (30) S37201-001 (34)	S43342-000
L7 (36 - 40mm)	S44274-001	S41474-101 S41475-101	S37201-001 (34) S35093-001 (38)	S43343-000

Note: There is 10 mm of difference in the knife cutting position between L1 – L4 and L5 – L7 specifications.

-52 specifications

Specifications (buttonhole length)	Plate R assembly Plate L assembly	Hammer	Specification harness	Cloth feed plate R
L1 (14 - 18mm)	S38576-301 S38577-201	S37702-001 (S12) S37704-001 (S16)	S43360-000	S43809-001
L2 (18 - 22mm)	S38578-301 S38579-201	S37704-001 (S16) S37706-001 (S20)	S43361-000	S43809-001
L3 (22 - 26mm)	S38580-301 S38581-201	S37706-001 (S20) S37708-001 (S24)	S43362-000	S42139-101
L4 (26 - 30mm)	S38582-301 S38583-201	S37708-001 (S24) S42053-001 (S28)	S43363-000	S42139-101
L5 (28 - 32mm)	S41470-101 S41471-101	S37197-001 (26) S37199-001 (30)	S43364-000	S43809-001
L6 (32 - 36mm)	S41472-101 S41473-101	S37199-001 (30) S37201-001 (34)	S43365-000	S42139-101
L7 (36 - 40mm)	S41474-101 S41475-101	S37201-001 (34) S35093-001 (38)	S43366-000	S42139-101

Note: There is 10 mm of difference in the knife cutting position between L1 – L4 and L5 – L7 specifications.

Special lapel cutting device

*When sewing straight buttonholes, needle rotates 6 mm in front of the tip of the eyelet buttonhole knife, so that the seam length for straight buttonholes will be as shown in the table.

*The standard hammers are 5 mm and 7 mm.

*The special lapel cutting device can be used only when the feed bracket is set to the front position.

Specifications	Eyelet buttonhole	Straight buttonhole
RH-981A-00	5 – 50 mm	5 – 44 mm
RH-981A-01	5 – 38 mm	5 – 32 mm

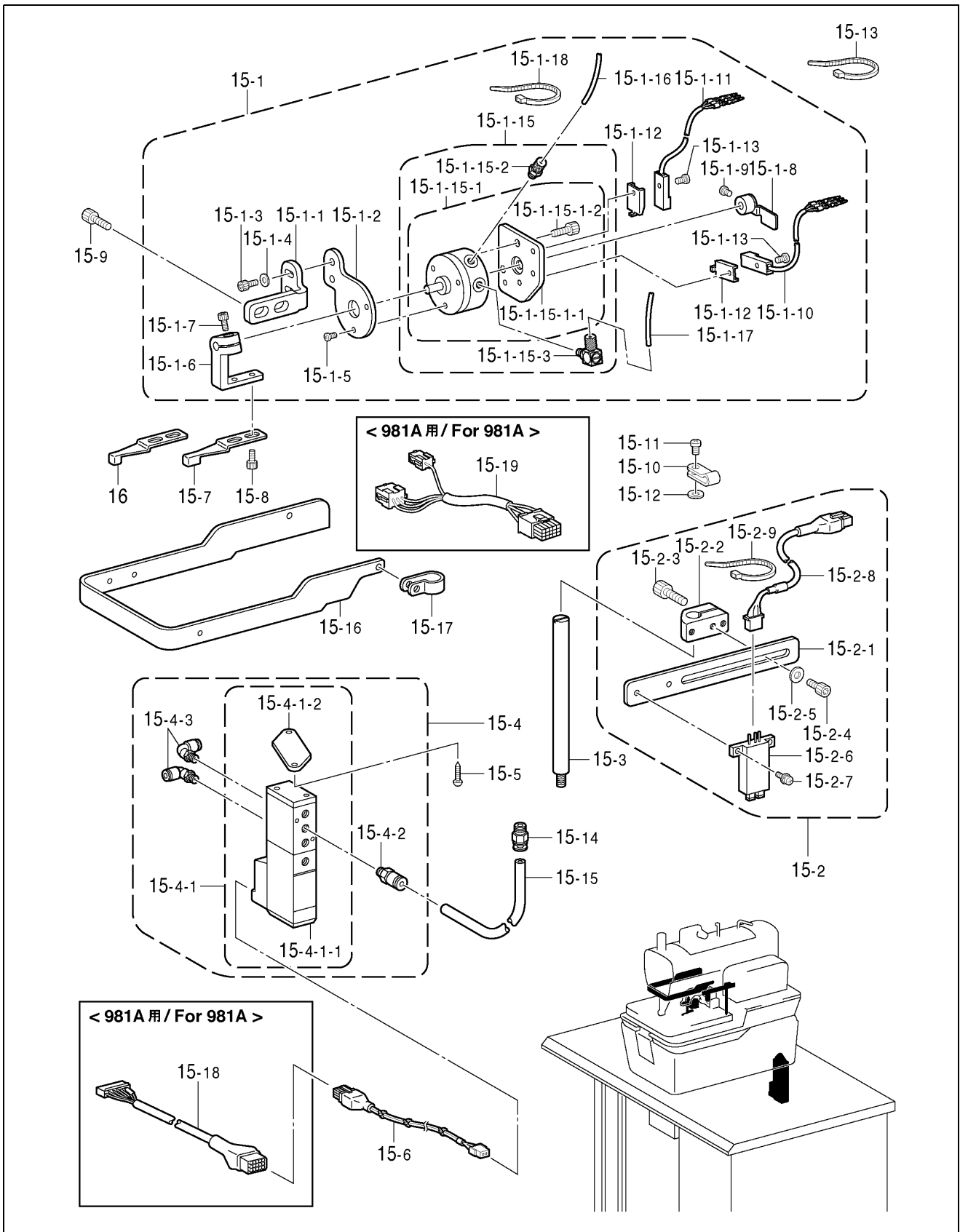

Ref. No.	Part name	Part code	Q'ty
15	Special lapel cutting device	S53906-101	1
15-1	Selector assy, hammer	S53907-001	1
15-1-1	Support plate, cylinder	S53908-001	1
15-1-2	Setting plate, cylinder	S53909-001	1
15-1-3	Bolt, socket SM3.57x8	154965-001	2
15-1-4	Washer, plain	105161-004	2
15-1-5	Screw, pan M3x6	062300-605	2
15-1-6	Setting lever, hammer	S53910-001	1
15-1-7	Bolt, socket SM3.57x8	154965-001	1
15-1-8	Partition plate, sensor	S53914-001	1
15-1-9	Set screw, SM3.57-40x4.5	144458-001	1
15-1-10	Sensor, hammer home position	S53915-000	1
15-1-11	Sensor, hammer position	S53916-000	1
15-1-12	Sensor bracket, MS-GL8	S53917-000	2
15-1-13	Screw, pan M3x8	062300-805	2
15-1-15	Rotary cylinder assy	S53918-001	1
15-1-1	Rotary cylinder plate assy	S54026-001	1
15-1-15-1-1	Setting plate, sensor	S53913-001	1
15-1-15-1-2	Bolt, socket M3x16	018301-636	2
15-1-15-2	Throttle tube joint	S19900-000	1
15-1-16	Tube elbow, w/valve	S16603-000	1
15-1-17	Air tube, 4x2.5-60	S53920-000	1
15-1-18	Air tube, 4x2.5-61	S53921-000	1
15-2	Band, PLT1M	S04557-000	1
15-2-	Sensor plate assy, B-hole	S53923-001	1
15-2-1	Setting plate, cloth sensor	S53924-001	1
15-2-2	Y-driving shaft holder	S31568-000	1
15-2-3	Bolt, socket M5x16	018501-622	1
15-2-4	Bolt, socket SM4.37x8	018680-822	2
15-2-5	Washer	100645-003	2
15-2-6	Photo sensor	S53925-000	1
15-2-7	Screw, pan (S/P washer) M3x8	0A4300-805	2
15-2-8	Harness, B-hole sensor	S53926-000	1
15-2-9	Band, PLT1M	S04557-000	1
15-3	Setting shaft, sensor	S53922-001	1
15-4	Valve assy	S53927-000	1
15-4-1	Valve, VZ3120-F	S53928-001	1
15-4-1-1	Valve, VZ3120	S13578-000	1
15-4-1-2	Bracket	S53929-000	1
15-4-2	Half union	S04905-000	1
15-4-3	Elbow union, 4M5	S11426-000	2
15-5	Wood screw, round M3.5x16	032361-602	2
15-6	Valve harness	S53930-000	1
15-7	Hammer plate, 7	S53911-001	1
15-8	Bolt, socket M3x5	018300-536	2
15-9	Bolt, socket M4x8	018400-832	2
15-10	Cord holder, 6N	146202-000	1
15-11	Screw, pan M4x16	062401-616	1
15-12	Washer, plain M6	025060-236	1
15-13	Band, PLT1M	S04557-000	3
15-14	Half union, ;KQH04-01S	S04910-000	1
15-15	Air tube, 4x2.5-62	S53939-000	1
15-16	Cover, H ;N-rotation	S53937-001	1
15-17	Cord holder, 10N	552907-000	1
15-18	Indexer cord	S43359-000	1
15-19	Selector harness	S59739-000	1
16	Hammer plate, 5	S53912-001	1

Fly indexer specifications (-52 specifications)

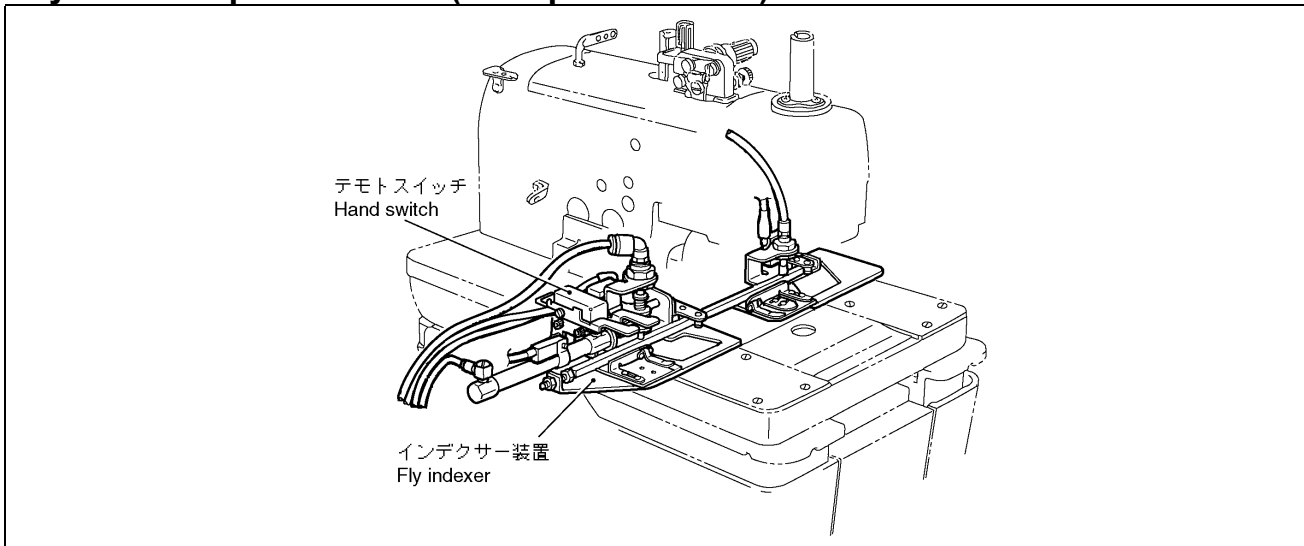

	Standard size	Large size
Applicable specifications	L1 (Buttonhole length : 14 - 18 mm), L2 (Buttonhole length : 18 - 22 mm), L3 (Buttonhole length : 22 - 26 mm), L4 (Buttonhole length : 26 - 30 mm)	L5 (Buttonhole length : 28 - 32 mm), L6 (Buttonhole length : 32 - 36 mm), L7 (Buttonhole length : 36 - 40 mm)
Distance between button holes	38.1 mm, 50.8 mm, 44.45 mm	38.1 mm, 50.8 mm, 44.45 mm, 57.15 mm
No. of buttonholes	1 - 4 holes	1 - 6 holes
Horizontal sewing margin	(L1 - L4) 9 - 21 mm, (L5 - L7) 9 - 11 mm	
Vertical sewing margin	30 - 40 mm	
Max. horizontal feed amount	152.4 mm	285.75 mm

*If the standard-sized fly indexer is used for sewing with a non-standard distance between buttonholes and a non-standard number of buttonholes (up to 9), you need to make additional holes in the cloth feed bar (F) assy (optional part). For this processing, refer to the instruction manual supplied with this optional part.

Part name	Part code	Applicable specifications
Cloth feed bar (F) assy (L1, L2)	S45193-101	L1, L2, L5
Cloth feed bar (F) assy (L3, L4)	S45194-101	L3, L4, L6, L7

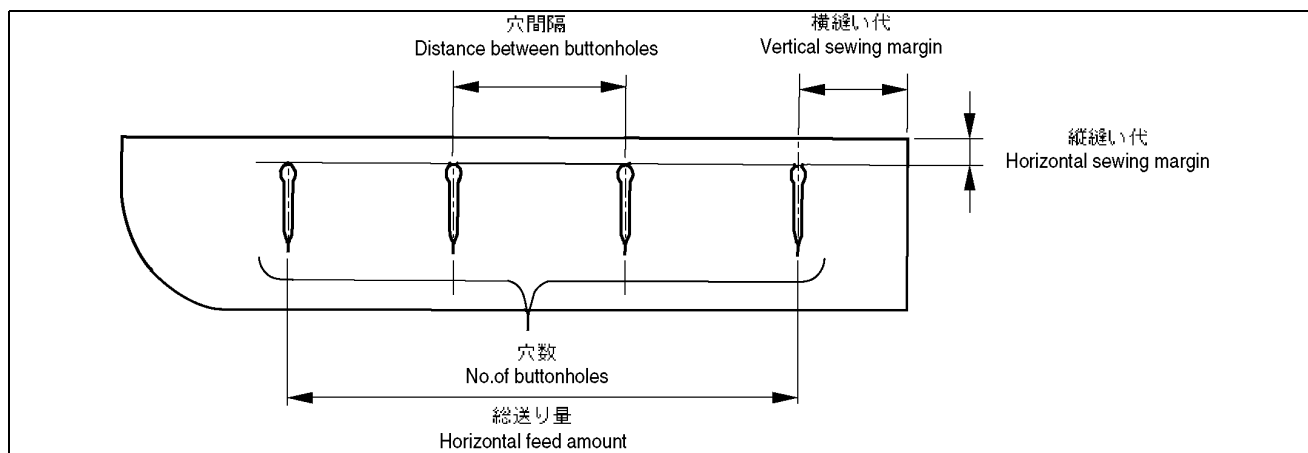

Part name	Part code	Applicable specifications
Fly indexer assy, 981	S44279-101	L1, L2, L5
	S44281-101	L3, L4, L6, L7

Different parts list

Work clamp

*10mm to 50mm work clamps are available for -00.

*10 to 38 mm work clamps are available for -01.

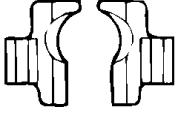
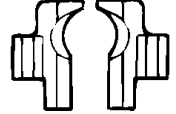
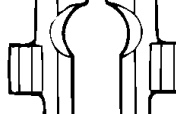
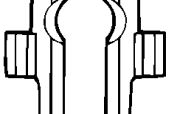
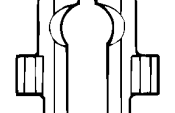
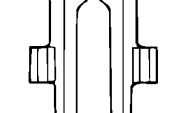
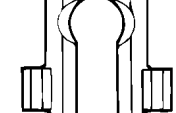
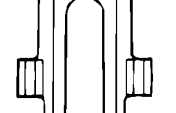
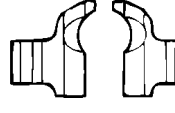
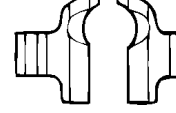
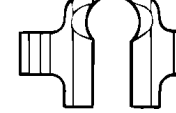
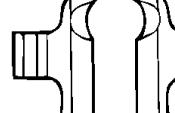
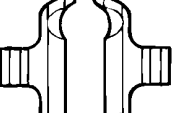
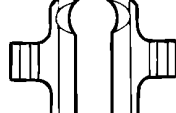
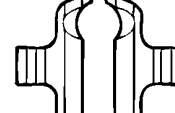
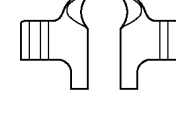
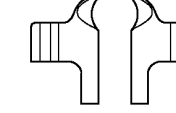
L	S35455-001	S39929-001	S35197-001	S39931-001
R	S35454-001	S39930-001	S35198-001	S39932-001
-00 & -01	<10 - 18 mm>	<18 - 22 mm>	<22 - 26 mm>	<26 - 30 mm>
				
	S35453-001	S35200-101	S37679-001	S37677-101
	S35452-001	S35199-101	S37680-001	S37678-101
	<26 - 38 mm>	<38 mm>	<50 mm>	<50 mm>
				
L	S37755-001	S37689-001	S37691-001	S37759-001
R	S37754-001	S37690-001	S37692-001	S37758-001
-02 & -52	L1 <14 - 18 mm>	L2 <18 - 22 mm>	L3 <22 - 26 mm>	L4 <26 - 30 mm>
				
	S41848-001	S41486-101	S41488-001	S43408-001
	S41483-001	S41485-101	S41487-001	S43409-001
	S41483-001	S41485-101	S41487-001	S43411-001
	L5 <28 - 32 mm>	L6 <32 - 36 mm>	L7 <36 - 40 mm>	L3W <22 - 26 mm>
				
				L4W <26 - 30 mm>
				
				<For waist belt presser>

Different parts list

Needle plate

*Both 38 mm and 50 mm needle plates are available for -00.

*Only 38 mm needle plates are available for -01.

L	S35308-101 (L)	S35307-101 (SL)	S37683-101 (L-50)	S37681-101 (SL-50)
R	S35309-101 (R)	S35306-101 (SR)	S37684-101 (R-50)	S37682-101 (SR-50)
-00 & -01	<38 mm>	<38 mm>	<50 mm>	<50 mm>
L	S37643-101 (L1L)	S37645-101 (L2L)	S37647-101 (L3L)	S37649-101 (L4L)
R	S37644-101 (L1R)	S37646-101 (L2R)	S37648-101 (L3R)	S37650-101 (L4R)
-02 & -52	L1 <14 - 18 mm>	L2 <18 - 22 mm>	L3 <22 - 26 mm>	L4 <26 - 30mm>
	S40823-001 (L5L)	S41480-001 (L6L)	S41482-001 (L7L)	
	S40822-001 (L5R)	S41479-001 (L6R)	S41481-001 (L7R)	
	L5 <28 - 32 mm>	L6 <32 - 36 mm>	L7 <36 - 40 mm>	

Knife

S35439-101 <38 mm>	S35437-101 <38 mm>	S35480-101 <38 mm>	S35482-101 <38 mm>	S55247-001 <38 mm>	S35408-101 (S) <38 mm>
S35438-101 <50 mm>	S35436-101 <50 mm>	S35481-101 <50 mm>	S35483-101 <50 mm>	S35409-101 (S) <50 mm>	

Different parts list Hammer





-00 & -01	Size (mm)	10	12	14	16
	Part code	S37211-001	S37210-001	S37209-001	S37208-001
	Size (mm)	18	20	22	24
	Part code	S37194-001	S35092-001	S37195-001	S37196-001
	Size (mm)	26	28	30	32
	Part code	S37197-001	S37198-001	S37199-001	S37200-001
	Size (mm)	34	36	38	50
	Part code	S37201-001	S37202-001	S35093-001	S35479-001
-02 & -52	Size (mm)	S10	S12	S14	S16
	Part code	S37701-001	S37702-001	S37703-001	S37704-001
	Size (mm)	S18	S20	S22	S24
	Part code	S37705-001	S37706-001	S37707-001	S37708-001
	Size (mm)	S26	S28		
	Part code	S37709-001	S42053-001		

Harness

-00 & -01	Specification	-			
	Part code	S43336-000			
-02	Specification	L1	L2	L3	L4
	Part code	S43337-000	S43338-000	S43339-000	S43340-000
	Specification	L5	L6	L7	
	Part code	S43341-000	S43342-000	S43343-000	
-52	Specification	L1	L2	L3	L4
	Part code	S43360-000	S43361-000	S43362-000	S43363-000
	Specification	L5	L6	L7	
	Part code	S43364-000	S43365-000	S43366-000	

Optional parts

Double chain stitch looper mechanism

Use	Eye Looper	Looper, R	Spreader, L	Spreader, R
				
Standard	S35411-001	S35410-001	S35413-101	S35412-101
For heavy	S35471-001		S35472-101	
For single chain stitch	S49078-001		S49079-001	

Throat plate

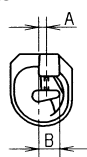
Use	Throat plate
	 
-00 and -01	A = 1.8 mm B = 4.6 mm S47033-001
-00 and -01 (For small hole)	A = 1.8 mm B = 4.6 mm S47034-001
-02	A = 1.8 mm B = 4.6 mm S37752-001
For straight bar tack	A = ----- B = 4.6 mm S39923-101