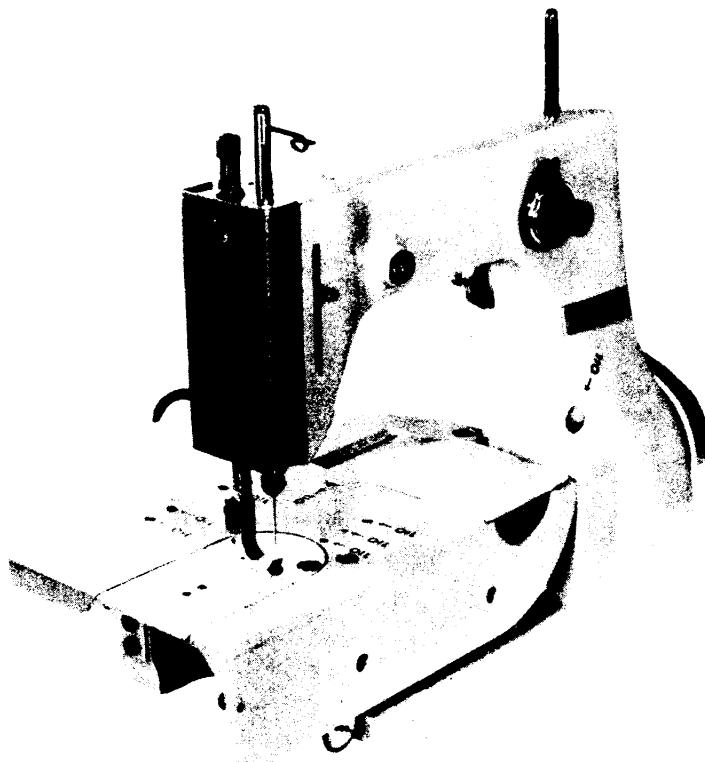

PARTS LIST

Cat. No. 9571

Dec. 1980

DM SERIES

MODELS: DM-10. DM-20. DM-50



PEGASUS®

IN ORDERING PARTS

This book has been arranged to simplify ordering repair parts for DM series machines, on the basis of model DM-10.

Various sections of the mechanisms are shown on each page. On the page opposite the illustrations will be found a listing of the parts with their reference numbers, parts numbers, names, the number of pieces required and the remarks.

At the back of this book, a numerical index of all parts is shown. This will facilitate locating the illustration and descriptions when only the part number is known.

Where parts for model DM-10 and other DM series machines are not the same, the difference is shown in the remarks column and on the page 10 to 15. When a part is used for all DM series machines covered by page 2 to 9 of this book, no machine model is mentioned in the remarks column.

In ordering parts from this book, the part number MUST be quoted exactly as it is shown in the second column on the page opposite the illustration. Reference number should never be used in ordering parts.

部品表御利用に際して

本部品表はDMシリーズ型の修理用部品を容易に御利用戴けます様にDM-10型を基本型に編集されています。

各頁には機構別に収録され、部品図解頁(左開き)の反対頁(右開き)には参照番号、部品番号、名称、使用数及び備考の順で記載されています。

本部品表の最終頁(18頁)には部品番号索引表を示し、部品番号のみでその図解、名称等が容易に引き出せる様になっています。

DM-10型用と他のDMシリーズ型用と異なる部品は備考欄に注記し10頁から15頁に異なる機種専用の部品を網羅しています。2頁から9頁にわたり備考欄に機種名の記載のない部品はDMシリーズの全機種に共通です。

部品御注文の際は、参照番号は絶対に使用せず、必ず部品番号のみを明示下さい。

本部品表は1970年10月現在製造中のDM型ミシン用に作成されております。

CONTENTS

| | 目次 | PAGE 頁 |
|--|---------------|-----------|
| ARM-BED AND MACHINE FRAME AND MISCELLANEOUS COVERS | アーム・ベッド・外部機構 | 2 ~ 3 |
| PRESSER FOOT AND NEEDLE BAR LINKAGE AND THREAD GUIDE MECHANISM ... | 押エ・針棒・糸道機構 | 4 ~ 5 |
| LOOPER DRIVE MECHANISM | ルーバー機構 | 6 ~ 7 |
| FEEDING AND LOWER SHAFT MECHANISM | 送り・主軸機構 | 8 ~ 9 |
| PARTS FOR MODEL DM-20 ONLY | DM-20型専用部品 | 10 ~ 11 |
| PARTS FOR MODEL DM-50 ONLY (1) | DM-50型専用部品(1) | 12 ~ 13 |
| PARTS FOR MODEL DM-50 ONLY (2) | DM-50型専用部品(2) | 14 ~ 15 |
| ACCESSORIES | 附属品 | 16 ~ 17 |
| INDEX | 部品番号索引 | 18 |



1

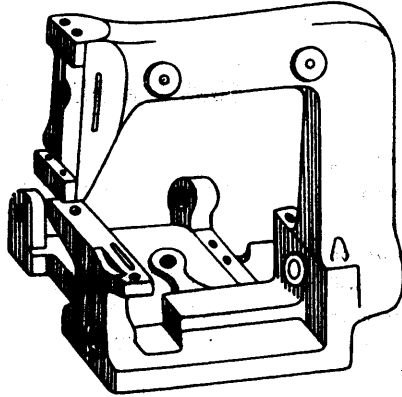

2



3



4

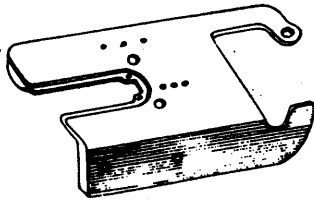

5



6



7

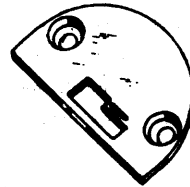

8



9

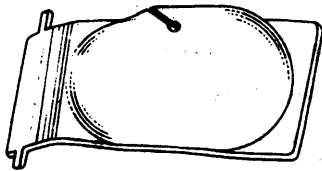

10



11



12



13

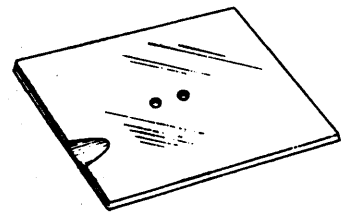

14



15



16

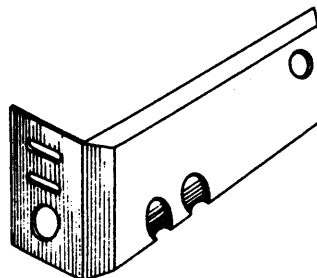

17



18

ARM-BED AND MACHINE FRAME AND MISCELLANEOUS COVERS

アーム・ベッド・外部機構

| Ref. No. | Parts No. | Name | 名称 | Qt. | Remarks |
|----------|-----------|------------------------|----------|-----|------------------|
| 参照番号 | 部品番号 | | | 数量 | 備考 |
| 1 | 200414 | Model plate | 形式板 | 1 | DM-10 only用 |
| 2 | 200405 | Machine arm-bed | アームベッド | 1 | DM-10 & 20 only用 |
| 3 | 200413 | Head cover | 面板 | 1 | DM-10 & 20 only用 |
| 4 | 1196 | ◇ ◇ screw | ◇ 止ネジ | 2 | |
| 5 | 167002 | Cloth plate | 平カバー | 1 | DM-10 & 50 only用 |
| 6 | 1382 | ◇ ◇ center-sunk screw | ◇ 止ネジ(皿) | 2 | |
| 7 | 2902 | ◇ ◇ screw | ◇ ◇ | 1 | |
| 8 | 167069 | Needle plate | 針板 | 1 | DM-10 only用 |
| 9 | 2905 | ◇ ◇ screw | ◇ 止ネジ | 2 | |
| 10 | 167064 | Looper thread cover | 裏糸調節器カバー | 1 | |
| 11 | 167065 | ◇ ◇ ◇ latch | ◇ 板バネ | 1 | |
| 12 | 1206 | ◇ ◇ ◇ ◇ screw | ◇ ◇ 止ネジ | 1 | |
| 13 | 167066 | ◇ ◇ ◇ ◇ washer | ◇ ◇ 座金 | 1 | |
| 14 | 200326 | Slide plate | 差板 | 1 | |
| 15 | 200327 | ◇ ◇ spring | ◇ 裏バネ | 1 | |
| 16 | 2906 | ◇ ◇ ◇ screw | ◇ ◇ 止ネジ | 2 | |
| 17 | 200582 | Machine bed rear cover | 後カバー | 1 | |
| 18 | 1216 | ◇ ◇ ◇ ◇ screw | ◇ 止ネジ | 3 | |

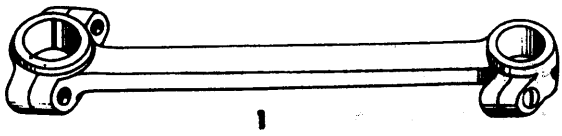

1



2



3

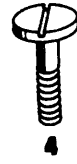

4



5

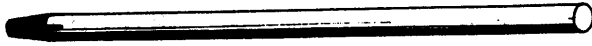

6



7



8



9



10



11



12



13



14



15

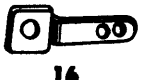

16



17

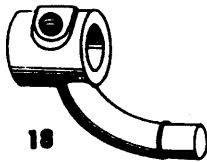

18



19

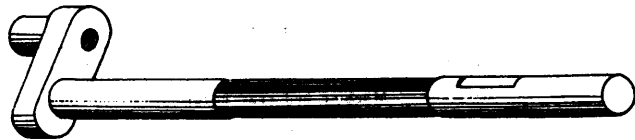

20



21



22



23



24



25



26



27



28



29



30



31



32



33



34



35



36



37



38



39



40



41



42



43



44



45



46



47

PRESSER FOOT AND NEEDLE BAR LINKAGE AND THREAD GUIDE MECHANISM

押エ・針棒・糸道機構

| Ref. No. 参照番号 | Parts No. 部品番号 | Name | 名称 | Qt. 数量 | Remarks 備考 |
|------------------|-------------------|--------------------------------|-------------|-----------|---------------|
| 1 | 200406 | Needle bar drive connection | 立ロッド | 1 | |
| 2 | 1174 | ◇ ◇ ◇ ◇ cap screw | ◇ 蓋止ネジ | 2 | |
| 3 | 1998 | ◇ ◇ ◇ ◇ screw | ◇ 調子ネジ | 1 | |
| 4 | 5124 | ◇ ◇ ◇ ◇ stud | ◇ スラストネジ | 1 | |
| 5 | 3044 | ◇ ◇ ◇ ◇ ◇ nut | ◇ ◇ ナット | 1 | |
| 6 | 167011 | ◇ bar | 針棒 | 1 | |
| 7 | 137123 | ◇ ◇ bushing | ◇ ブッシュ | 2 | |
| 8 | 1457 | ◇ ◇ ◇ screw | ◇ ◇ 止ネジ | 2 | |
| 9 | 167012 | ◇ clamp nut | 針止ナット | 1 | DM-10 & 20 専用 |
| 10 | 167013 | ◇ bar thread eyelet | 針棒糸道 | 1 | |
| 11 | 2921 | ◇ ◇ ◇ ◇ screw | ◇ 止ネジ | 1 | |
| 12 | 155124 | ◇ ◇ clamp | 針棒抱キ | 1 | |
| 13 | 1998-2 | ◇ ◇ ◇ screw | ◇ 止ネジ | 1 | |
| 14 | 167009 | ◇ ◇ drive link | 針棒リング | 1 | |
| 15 | 2297 | ◇ ◇ ◇ ◇ screw | ◇ ◇ 止ネジ | 2 | |
| 16 | 167078 | ◇ thread take-up | ◇ ◇ 糸道 | 1 | |
| 17 | 2922 | ◇ ◇ ◇ screw | ◇ ◇ ◇ 止ネジ | 1 | |
| 18 | 167008 | Arm shaft drive lever | 上軸レバー | 1 | DM-10 & 20 専用 |
| 19 | 2022 | ◇ ◇ ◇ ◇ screw | ◇ 止ネジ | 2 | |
| 20 | 200407 | ◇ shaft | 上軸 | 1 | DM-10 & 20 専用 |
| 21 | 200409 | ◇ ◇ collar | ◇ スラストカラー | 1 | |
| 22 | 1457-1 | ◇ ◇ ◇ screw | ◇ ◇ 止ネジ | 2 | |
| 23 | 200410 | ◇ ◇ bushing | ◇ ブッシュ | 1 | |
| 24 | 1435 | ◇ ◇ ◇ screw | ◇ ◇ 止ネジ | 1 | |
| 25 | 202033 | ◇ ◇ ◇ oil wick | 上軸給油フェルト | 1 | |
| 26 | 167048 | Presser bar | 押エ棒 | 1 | DM-10 & 50 専用 |
| 27 | 167049A | ◇ ◇ clamp | ◇ 案内金 | 1 | DM-10 & 20 専用 |
| 28 | 1448 | ◇ ◇ ◇ screw | ◇ ◇ 止ネジ | 1 | |
| 29 | 167050 | ◇ ◇ ◇ guide | ◇ ◇ 止板 | 1 | |
| 30 | 2918 | ◇ ◇ ◇ screw | ◇ ◇ ◇ 止ネジ | 2 | |
| 31 | 167052 | ◇ bar spring | 押エバネ | 1 | DM-10 & 20 専用 |
| 32 | 2106 | ◇ ◇ ◇ adjusting screw | ◇ 調節ネジ | 1 | |
| 33 | 167054 | ◇ foot | 押エ | 1 | DM-10 専用 |
| 34 | 1196 | ◇ ◇ screw | ◇ 止ネジ | 1 | |
| 35 | 167055 | ◇ ◇ hand lifting lever | 押エ手上げ | 1 | DM-10 & 20 専用 |
| 36 | 155148 | ◇ ◇ ◇ ◇ ◇ stud | ◇ ピン | 1 | |
| 37 | 1458 | ◇ ◇ ◇ ◇ ◇ screw | ◇ ◇ 止ネジ | 1 | |
| 38 | 167079 | Needle thread eyelet | 前糸道 | 1 | |
| 39 | 2905 | ◇ ◇ ◇ screw | ◇ 止ネジ | 1 | |
| 40 | 167071 | Looper thread eyelet | 裏糸道 | 1 | DM-10 & 50 専用 |
| 41 | 1206 | ◇ ◇ ◇ screw | ◇ 止ネジ | 1 | |
| 42 | 167072 | Thread tension post | 糸調子棒 | 2 | |
| 43 | 3056 | ◇ ◇ ◇ nut | ◇ ナット | 2 | |
| 44 | 167075 | ◇ ◇ spring (for needle thread) | 渦巻バネ太(針糸用) | 1 | |
| 45 | 167077 | ◇ ◇ ◇ (for looper thread) | ◇ 細(ルーバー糸用) | 1 | |
| 46 | 101111 | ◇ ◇ disc | 糸調子皿 | 4 | |
| 47 | 137106 | ◇ ◇ plate | ◇ 台 | 2 | |

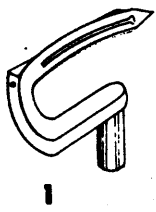

1



2

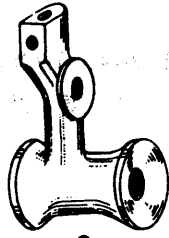

3



4



5

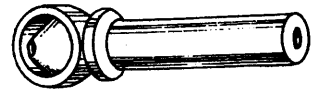

6



7



8

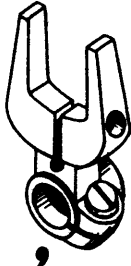

9



10



11

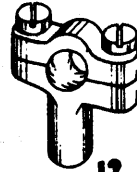

12



13



14



15



16



17



18



19

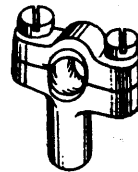

20



21



22

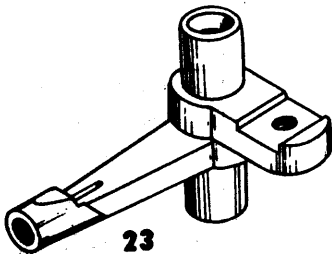

23



24



25



26



27

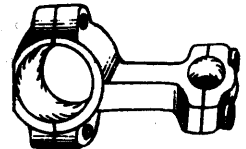

28



29



30



31

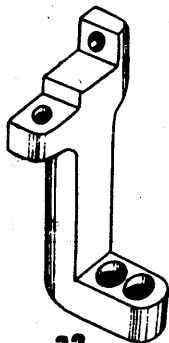

32



33

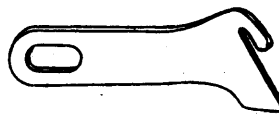

34



35



36



37



38



39



40



41



42



43

LOOPER DRIVE MECHANISM

ル ー パ ー 機 構

| Ref. No. | Parts No. | Name | 名 称 | Qt. | Remarks |
|----------|-----------|---|-----------------|-----|---------|
| 参照番号 | 部品番号 | | | 数量 | 備考 考 |
| 1 | 167030 | Looper | ルーバー | 1 | |
| 2 | 2924 | ◇ screw | ◇ 止ネジ | 1 | |
| 3 | 200399 | ◇ holder | ルーバー台 | 1 | |
| 4 | 167027 | ◇ ◇ cone head screw | ◇ テーパー軸 | 1 | |
| 5 | 3018 | ◇ ◇ ◇ ◇ ◇ nut | ◇ ◇ ナット | 1 | |
| 6 | 167028 | ◇ avoiding shaft | ルーバーシャフト | 1 | |
| 7 | 167029 | ◇ ◇ ◇ collar | ◇ カラー | 1 | |
| 8 | 1457 | ◇ ◇ ◇ ◇ screw | ◇ ◇ 止ネジ | 1 | |
| 9 | 167032 | ◇ ◇ ◇ drive arm | ルーバー前後レバー | 1 | |
| 10 | 2928 | ◇ ◇ ◇ ◇ ◇ adjusting screw | ◇ 調節止ネジ | 1 | |
| 11 | 2902 | ◇ ◇ ◇ ◇ ◇ screw | ◇ 止ネジ | 1 | |
| 12 | 200397 | ◇ drive connection head (left) | ルーバー振りロッド球受左 | 1 | |
| 13 | 1174 | ◇ ◇ ◇ ◇ ◇ cap screw | ◇ 蓋止ネジ | 2 | |
| 14 | 200400 | ◇ ◇ ◇ ◇ ◇ ball stud | ルーバー振りロッド球(C) | 1 | |
| 15 | 3018 | ◇ ◇ ◇ ◇ ◇ ◇ ◇ nut | ◇ ナット | 1 | |
| 16 | 200398 | ◇ ◇ ◇ ◇ ◇ silencer | ルーバー振りロッド球受振レ止メ | 1 | |
| 17 | 167023 | ◇ ◇ ◇ connecting rod | 連結棒 | 1 | |
| 18 | 3091 | ◇ ◇ ◇ ◇ ◇ nut (right thread) | ◇ ナット(右ネジ) | 1 | |
| 19 | 3092 | ◇ ◇ ◇ ◇ ◇ ◇ (left thread) | ◇ ◇ (左ネジ) | 1 | |
| 20 | 200396 | ◇ ◇ ◇ ◇ ◇ connection head (right) | ルーバー振りロッド球受右 | 1 | |
| 21 | 1174 | ◇ ◇ ◇ ◇ ◇ ◇ cap screw | ◇ 蓋止ネジ | 2 | |
| 22 | 200395 | ◇ ◇ ◇ ◇ ◇ connection head (right) | ルーバー振りロッド球(B) | 1 | |
| 23 | 200393 | ◇ ◇ ◇ ◇ ◇ lever | ルーバーレバー | 1 | |
| 24 | 167020 | ◇ ◇ ◇ ◇ ◇ stud | 立シャフト | 1 | |
| 25 | 200492 | ◇ ◇ ◇ ◇ ◇ ◇ oil wick | ◇ 給油フェルト | 1 | |
| 26 | 200394 | ◇ ◇ ◇ ◇ ◇ ◇ connection ball stud | ルーバー振りロッド球(A) | 1 | |
| 27 | 3094 | ◇ ◇ ◇ ◇ ◇ ◇ ◇ nut | ◇ ナット | 1 | |
| 28 | 200391 | ◇ ◇ ◇ ◇ ◇ ◇ connection | ルーバー振りロッド | 1 | |
| 29 | 2213-1 | ◇ ◇ ◇ ◇ ◇ ◇ cap screw (large) | ◇ 蓋止ネジ大 | 2 | |
| 30 | 1174 | ◇ ◇ ◇ ◇ ◇ ◇ ◇ (small) | ◇ ◇ 小 | 2 | |
| 31 | 200392 | ◇ ◇ ◇ ◇ ◇ ◇ silencer | ◇ 振り止メ | 1 | |
| 32 | 200412 | ◇ ◇ ◇ ◇ ◇ thread stand | 裏糸調子台 | 1 | |
| 33 | 2133-1 | ◇ ◇ ◇ ◇ ◇ ◇ screw | ◇ 止ネジ | 2 | |
| 34 | 167060 | ◇ ◇ ◇ ◇ ◇ ◇ cast-off | 糸サバキ | 1 | |
| 35 | 1175-2 | ◇ ◇ ◇ ◇ ◇ ◇ screw | ◇ 止ネジ | 1 | |
| 36 | 167061 | ◇ ◇ ◇ ◇ ◇ ◇ washer | ◇ 座金 | 1 | |
| 37 | 167058 | ◇ ◇ ◇ ◇ ◇ ◇ staple | 二又糸道 | 1 | |
| 38 | 1175-2 | ◇ ◇ ◇ ◇ ◇ ◇ ◇ screw | ◇ 止ネジ | 1 | |
| 39 | 167059 | ◇ ◇ ◇ ◇ ◇ ◇ ◇ take-up thread guide eyelet | 二又糸道案内 | 2 | |
| 40 | 2935 | ◇ ◇ ◇ ◇ ◇ ◇ ◇ ◇ screw | ◇ 止ネジ | 2 | |
| 41 | 167062 | ◇ ◇ ◇ ◇ ◇ ◇ ◇ nipper | 裏糸道調節板バネ上 | 1 | |
| 42 | 167063 | ◇ ◇ ◇ ◇ ◇ ◇ ◇ plate | ◇ 下 | 1 | |
| 43 | 1175-2 | ◇ ◇ ◇ ◇ ◇ ◇ ◇ ◇ screw | ◇ 止ネジ | 1 | |

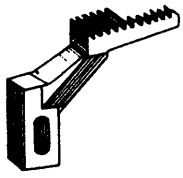

1



2

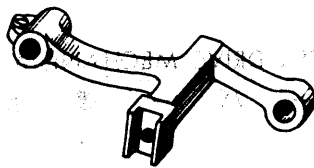

3



4

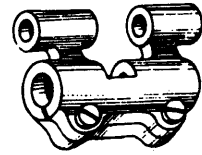

5



6



7



8



9

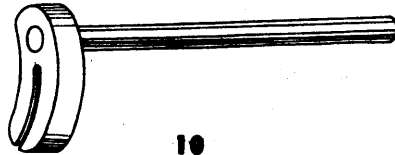

10

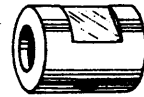

11



12

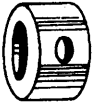

13



14

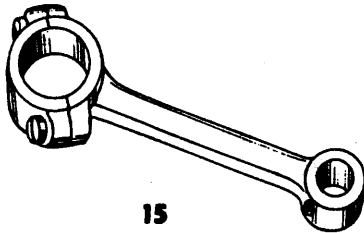

15



16



17



18



19



20

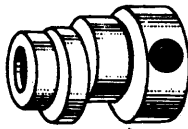

21



22

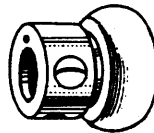

23



24

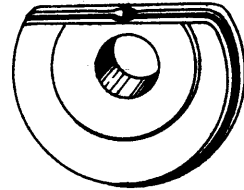

25



26



27



28



29

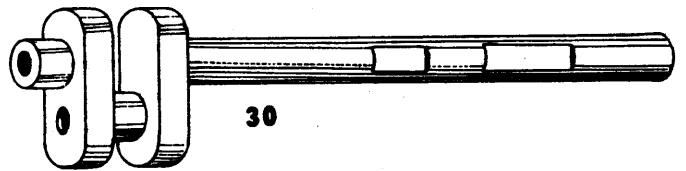

30

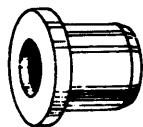

31



32

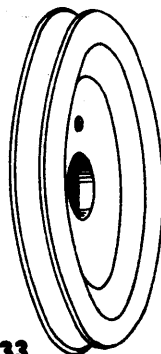

33



34

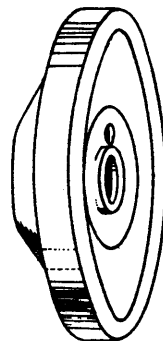

35



36

FEEDING AND LOWER SHAFT MECHANISM

送 り ・ 主 軸 機 構

| Ref. No. 参照番号 | Parts No. 部品番号 | Name | 名 称 | Qt. 数量 | Remark 備 考 |
|------------------|-------------------|--|-----------------------------------|-----------|------------------|
| 1 | 167047 | Feed dog | 送り歯 | 1 | DM-10 only用 |
| 2 | 1175-2 | ◇ ◇ screw | ◇ 止ネジ | 1 | |
| 3 | 167045 | ◇ bar | 送り台 | 1 | |
| 4 | 2924 | ◇ ◇ screw | ◇ 止ネジ | 1 | |
| 5 | 200411 | ◇ rocker | 送り二又リンク | 1 | |
| 6 | 2213-1 | ◇ ◇ screw | ◇ 止ネジ | 2 | |
| 7 | 167042A | ◇ ◇ drive shaft | 送り台リンクピン | 1 | |
| 8 | 200425 | ◇ ◇ ◇ ◇ collar | ◇ 二又リンクスラストカラー | 1 | |
| 9 | 5053 | ◇ ◇ ◇ ◇ ◇ screw | ◇ ◇ 止ネジ | 1 | |
| 10 | 167043 | ◇ ◇ shaft, complete with 167044, 167039, 5084 | 送り調節レバー-167044, 167039 5084トノ組 | 1 | DM-10 & 20 only用 |
| 11 | 167038-2 | ◇ ◇ ◇ bushing | 送りシャフトブッシュ | 1 | |
| 12 | 1435 | ◇ ◇ ◇ ◇ screw | ◇ ◇ 止ネジ | 1 | |
| 13 | 167041 | ◇ ◇ ◇ collar | ◇ カラー | 1 | |
| 14 | 1206 | ◇ ◇ ◇ ◇ screw | ◇ ◇ 止ネジ | 1 | |
| 15 | 167034 | ◇ drive connection | 送り前後ロッド | 1 | |
| 16 | 2213-1 | ◇ ◇ ◇ cap screw | ◇ 蓋止ネジ | 2 | |
| 17 | 167035 | ◇ ◇ ◇ bushing | ◇ ブッシュ | 1 | |
| 18 | 167036 | ◇ ◇ segment stud | 送り調節ネジ | 1 | |
| 19 | 5067 | ◇ ◇ ◇ ◇ nut | ◇ ナット | 1 | |
| 20 | 167046 | ◇ lift connection | 送り上下ロッド | 1 | |
| 21 | 167031 | ◇ ◇ eccentric | 送り上下ルーバー前後カム | 1 | DM-10 & 50 only用 |
| 22 | 2913-1 | ◇ ◇ ◇ screw | ◇ 止ネジ | 2 | |
| 23 | 167016 | Looper drive eccentric | ルーバー振りカム | 1 | |
| 24 | 2913-1 | ◇ ◇ ◇ ◇ screw | ◇ 止ネジ | 2 | |
| 25 | 167056 | ◇ thread take-up | 裏糸調節器 | 1 | |
| 26 | 1457-1 | ◇ ◇ ◇ ◇ screw | ◇ 止ネジ | 1 | |
| 27 | 167033 | Feed drive eccentric | 送り前後カム | 1 | DM-10 only用 |
| 28 | 2913-1 | ◇ ◇ ◇ ◇ screw (long) | ◇ 止ネジ(長) | 1 | |
| 29 | 2913-2 | ◇ ◇ ◇ ◇ ◇ (short) | ◇ ◇ (短) | 1 | |
| 30 | 167014 | Lower shaft | クランクシャフト | 1 | |
| 31 | 167082 | ◇ ◇ bushing | 下軸ブッシュ | 2 | |
| 32 | 201767 | ◇ ◇ ◇ ◇ oil wick | ◇ 給油フェルト(右) | 1 | |
| 33 | 167003 | Pulley | プーリー | 1 | |
| 34 | 2947 | ◇ screw | ◇ 止ネジ | 1 | |
| 35 | 200419 | Hand wheel | フライホイール | 1 | |
| 36 | 2948 | ◇ ◇ screw | ◇ 止ネジ | 1 | |

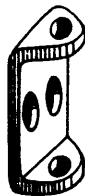
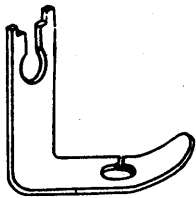
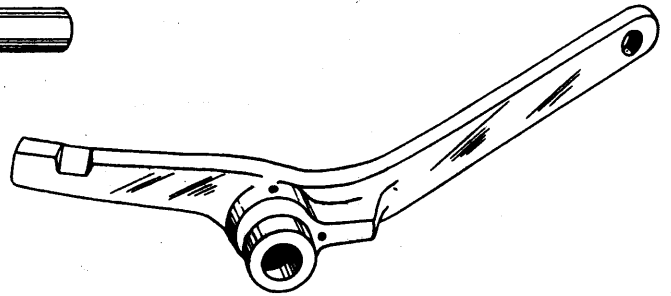
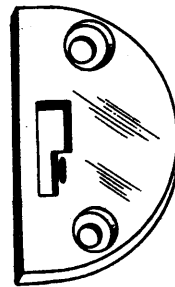
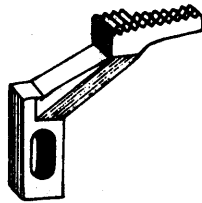
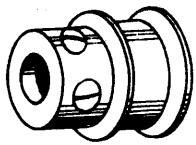
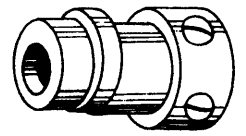
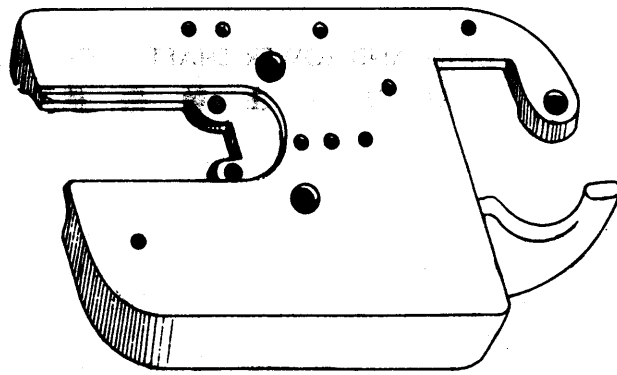

PARTS FOR MODEL DM-20 ONLY
DM-20 専用部品

| Ref. No. 参照番号 | Parts No. 部品番号 | Name | 名称 | Qt. 数量 | Remarks 備考 |
|------------------|-------------------|--|--------------|-----------|--------------------------|
| 1 | 200416 | Model plate | 形式板 | 1 | |
| 2 | 168002 | Cloth plate | 平カバー | 1 | |
| 3 | 168031 | Feed lift eccentric | 送り上下ルーバー前後カム | 1 | |
| 4 | 168033 | ◇ drive eccentric | 送り前後カム | 1 | Also for DM-20 & 50共用 |
| 5 | 168047 | ◇ dog | 送り歯 | 1 | |
| 6 | 168069 | Needle plate | 針板 | 1 | |
| 7 | 155141 | Presser bar | 押エ棒 | 1 | |
| 8 | 155160 | ◇ foot screw | 押エ | 1 | |
| 9 | 1205 | ◇ ◇ screw | ◇ 止ネジ | 1 | |
| 10 | 200417 A | ◇ ◇ lifting lever | 押エ足揚ゲ | 1 | |
| 11 | 2900-1 | ◇ ◇ ◇ pivot screw | ◇ 取付ネジ | 1 | Also for DM-20 & 50共用 |
| 12 | 137147 | ◇ ◇ ◇ spring | ◇ バネ | 1 | |
| 13 | 201167 A | ◇ ◇ ◇ stop bracket | ◇ 調節台(コ形) | 1 | |
| 14 | 5142 | ◇ ◇ ◇ ◇ screw | ◇ ◇ 止ネジ | 2 | |
| 15 | 2133 | ◇ ◇ ◇ ◇ screw | ◇ 調節ネジ | 2 | |
| 16 | 3044 | ◇ ◇ ◇ ◇ ◇ nut | ◇ ◇ ナット | 2 | |
| 17 | 168071 | Looper thread eyelet | 裏糸道 | 1 | |
| 18 | 167066 | ◇ ◇ ◇ washer | ◇ 座金 | 1 | |
| 19 | 200488 | Presser foot lifting lever connecting link | 足揚ゲ連結桿 | 1 | |
| 20 | 5099 | ◇ ◇ ◇ ◇ ◇ nut | ◇ ◇ ナット | 2 | |

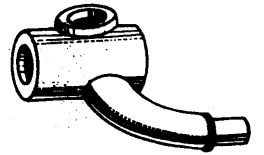
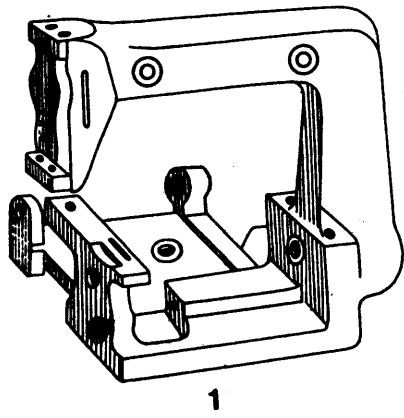

2

3

1



4

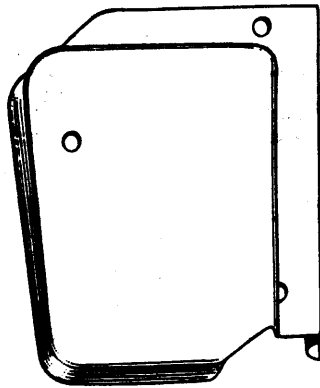

5



6



7

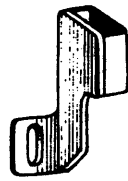

8



9

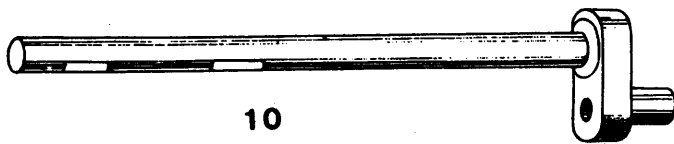

10



11



12

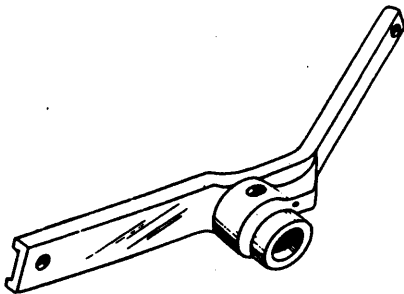

13

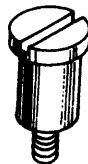

14

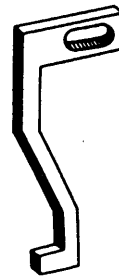

15



16



17



18

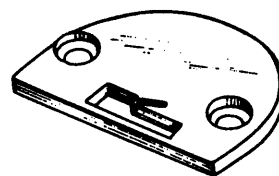

19

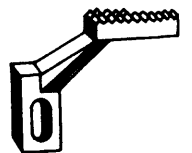

20

PARTS FOR MODEL DM-50 ONLY(1)

DM-50 専用部品(その1)

| Ref. No. | Parts No. | Name | 名称 | Qt. | Remarks |
|----------|-----------|---------------------------------|---------|-----|---------|
| 参照番号 | 部品番号 | | | 数量 | 備考 |
| 1 | 200540 | Machine arm-bed | アームベッド | 1 | |
| 2 | 200541 | Model plate | 形式板 | 1 | |
| 3 | 200542 | Arm shaft drive lever | 上軸レバー | 1 | |
| 4 | 200543 | Presser bar spring | 押エバネ | 1 | |
| 5 | 200544 | Head cover | 面板 | 1 | |
| 6 | 1196 | ◇ ◇ screw | ◇ 止ネジ | 3 | |
| 7 | 200545 | ◇ ◇ stud | ◇ ◇ 座 | 1 | |
| 8 | 200546 A | Needle guard, complete | 針受(組) | 1 | |
| 9 | 1175-2 | ◇ ◇ screw | ◇ 止ネジ | 1 | |
| 10 | 200547 | Arm shaft | 上シャフト | 1 | |
| 11 | 200570 | Presser foot hand lifting lever | 押エ手揚ゲ | 1 | |
| 12 | 200571 | Needle clamp nut | 針止メナット | 1 | |
| 13 | 200548 | Presser foot lifting lever | 押エ足揚ゲ | 1 | |
| 14 | 2900-1 | ◇ ◇ ◇ ◇ stop bracket | ◇ 取付ネジ | 1 | |
| 15 | 200549 | ◇ ◇ ◇ link | ◇ 掛金 | 1 | |
| 16 | 1202 | ◇ ◇ ◇ ◇ screw | ◇ ◇ 止ネジ | 1 | |
| 17 | 200550 | Feed rocker drive shaft | 送りシャフト | 1 | |
| 18 | 200551 | Presser foot | 押エ | 1 | |
| 19 | 200572 | Needle plate | 針板 | 1 | |
| 20 | 200574 | Feed dog | 送り歯 | 1 | |

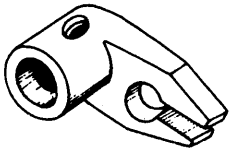

1



2

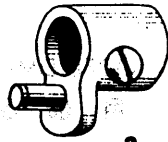

3



4



5



6



7

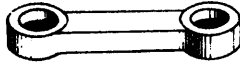

8



9

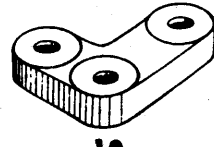

10

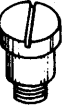

11

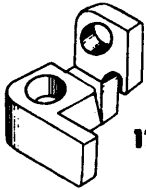

12



13



14

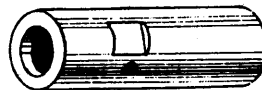

15



16



17



18



19



20

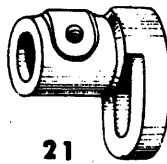

21



22



23

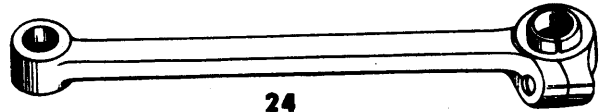

24



25



26



27



28



29

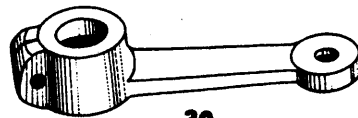

30



31

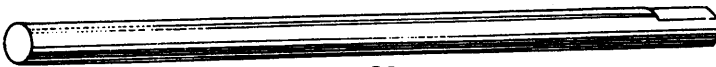

32



33



34



35



36



37



38

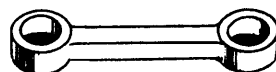

39



40

PARTS FOR MODEL DM-50 ONLY(2)

DM-50 専用部品(その2)

| Ref. No. | Parts No. | Name | 名称 | Qt. | Remarks |
|----------|-----------|---------------------------------|---------------|-----|---------|
| 参照番号 | 部品番号 | | | 数量 | 備考 |
| 1 | 200552 | Walking foot lift fork | 上送り上下二又 | 1 | |
| 2 | 5060 | ◇ ◇ ◇ ◇ screw | ◇ 止ネジ | 2 | |
| 3 | 200553 | ◇ ◇ ◇ drive connection | 上送り上下レバー | 1 | |
| 4 | 2913-2 | ◇ ◇ ◇ ◇ ◇ screw | ◇ 止ネジ | 2 | |
| 5 | 200554 | ◇ ◇ ◇ ◇ ◇ roller | ◇ ローラー | 1 | |
| 6 | 200555 | ◇ ◇ ◇ ◇ ◇ roller retaining ring | ◇ ◇ 抜止 | 1 | |
| 7 | 200556 | ◇ ◇ ◇ ◇ shaft | 送り上下シャフト | 1 | |
| 8 | 200557 | ◇ ◇ ◇ ◇ link | 上送り上下ロッド | 1 | |
| 9 | 5148 | ◇ ◇ ◇ ◇ ◇ stud | ◇ 段ネジ | 2 | |
| 10 | 200558 | ◇ ◇ ◇ ◇ bell crank | 上送り上下L形レバー | 1 | |
| 11 | 5148 | ◇ ◇ ◇ ◇ link stud | ◇ 段ネジ | 1 | |
| 12 | 200559 | Presser bar clamp | 押エ棒抱キ | 1 | |
| 13 | 200560 | Walking foot link | 上送り台 | 1 | |
| 14 | 5148 | ◇ ◇ ◇ stud | ◇ 段ネジ | 1 | |
| 15 | 200561 | ◇ ◇ lift drive shaft bushing | 上送り上下シャフトブッシュ | 1 | |
| 16 | 2022 | ◇ ◇ ◇ ◇ ◇ ◇ screw | ◇ ◇ 止ネジ | 1 | |
| 17 | 167050 | ◇ ◇ link guide | 上送り台案内金 | 1 | |
| 18 | 2918 | ◇ ◇ ◇ ◇ screw | ◇ 止ネジ | 2 | |
| 19 | 200562 | ◇ foot | 上送り歯 | 1 | |
| 20 | 1196 | ◇ ◇ screw | ◇ 止ネジ | 1 | |
| 21 | 200563 | ◇ ◇ adjusting bell lever | 上送り前後調節器 | 1 | |
| 22 | 5059 | ◇ ◇ ◇ ◇ ◇ screw (long) | ◇ 止ネジ | 1 | |
| 23 | 5060 | ◇ ◇ ◇ ◇ ◇ (short) | ◇ ◇ | 1 | |
| 24 | 200564 | ◇ ◇ drive connection | 上送り前後立ロッド | 1 | |
| 25 | 137420 | ◇ ◇ ◇ ◇ stud | ◇ 段ネジ | 1 | |
| 26 | 200565 | ◇ ◇ ◇ ◇ nut | ◇ ナット | 1 | |
| 27 | 137441 | ◇ ◇ ◇ ◇ washer | ◇ 座金 | 1 | |
| 28 | 2366 | ◇ ◇ ◇ ◇ conical stud | ◇ テーパーネジ | 1 | |
| 29 | 3018 | ◇ ◇ ◇ ◇ ◇ nut | ◇ ナット | 1 | |
| 30 | 200566 | ◇ ◇ ◇ arm (right) | 上送り前後レバー(右) | 1 | |
| 31 | 1175-2 | ◇ ◇ ◇ ◇ ◇ screw | ◇ 締ネジ | 1 | |
| 32 | 200567 | ◇ ◇ ◇ shaft | 上送り前後シャフト | 1 | |
| 33 | 200575 | ◇ ◇ ◇ ◇ washer retaining | ◇ 止輪 | 1 | |
| 34 | 200576 | ◇ ◇ ◇ ◇ washer | ◇ 座金 | 1 | |
| 35 | 200408 | ◇ ◇ ◇ ◇ collar | ◇ カラー | 1 | |
| 36 | 1457-1 | ◇ ◇ ◇ ◇ ◇ screw | ◇ ◇ 止ネジ | 2 | |
| 37 | 200568 | ◇ ◇ ◇ arm (left) | 上送り前後レバー(左) | 1 | |
| 38 | 5060 | ◇ ◇ ◇ ◇ ◇ screw | ◇ 止ネジ | 2 | |
| 39 | 200569 | ◇ ◇ ◇ link | 上送り前後ロッド | 1 | |
| 40 | 5148 | ◇ ◇ ◇ ◇ stud | ◇ 段ネジ | 2 | |

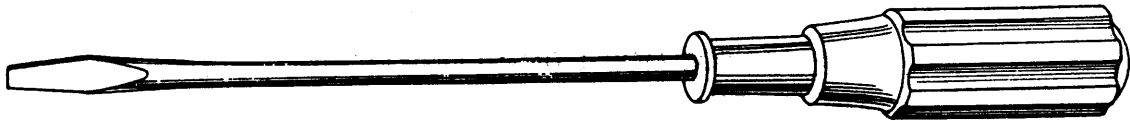

1

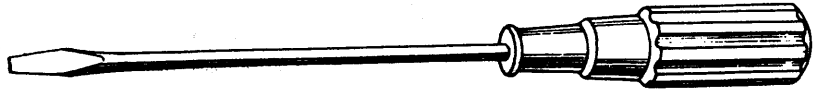

2



3

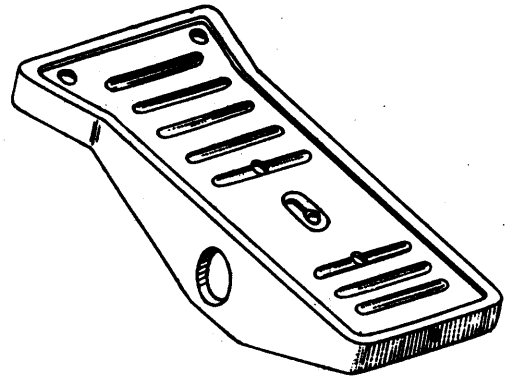
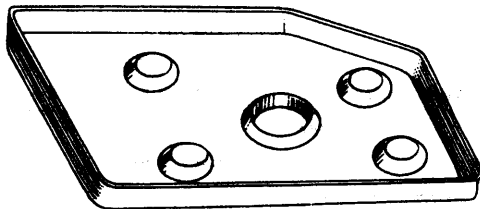

5

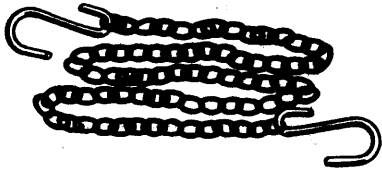

6

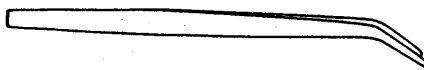

7

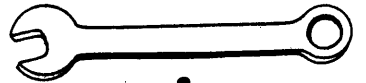

8

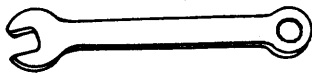

9



10

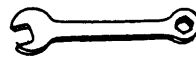

11

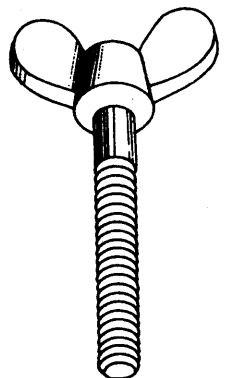

12



13



14



15



16



17

ACCESSORIES

付 属 品

| Ref. No. 参照番号 | Parts No. 部品番号 | Name | 名 称 | Qt. 数量 | Remarks 備 考 |
|------------------|-------------------|--|----------------------|-----------|----------------|
| 1 | 127 | Screw driver (large) | ドライバー(大) | 1 | |
| 2 | 128 | ◇ ◇ (medium) | ◇ (中) | 1 | |
| 3 | 132 | Oiler (containing 50cc oil) | 油差し | 1 | |
| 4 | 200415 | Oil pan | オイルパン | 1 | |
| 5 | 121 | Treadle | 鞆(組) | 1 | |
| 6 | 126 | ◇ chain | 鎖 | 1 | |
| 7 | 131 A | Tweezers | ピンセット | 1 | |
| 8 | 130 A-9.5 | Wrench (9.5mm) | スパナ(9.5mm用) | 1 | |
| 9 | 130 A-7 | ◇ (7.0mm) | ◇ (7.0mm用) | 1 | |
| 10 | 130 A-6 | ◇ (6.0mm) | ◇ (6.0mm用) | 1 | |
| 11 | 130 A-4 | ◇ (4.0mm) | ◇ (4.0mm用) | 1 | |
| 12 | 155138 | Machine mount screw | 機ネジ | 1 | |
| 13 | 167081 | Cloth guide | 定規 | 1 | |
| 14 | 1285 | ◇ ◇ screw | ◇ 止ネジ | 1 | |
| 15 | DM x 13 | Needle, size No.9 (for model DM-10 only) | 針(DM×13#9)(DM-10型用) | 10 | |
| 16 | DM x 13 | ◇ ◇ No.11 (for model DM-20 only) | ◇(DM×13#11)(DM-20型用) | 10 | |
| 17 | DM x 13 | ◇ ◇ No.14 (for model DM-50 only) | ◇(DM×13#14)(DM-50型用) | 10 | |

NUMERICAL INDEX OF PARTS

部 品 番 号 索 引

| Parts No. | Page | Ref. No. | Parts No. | Page | Ref. No. | Parts No. | Page | Ref. No. | Parts No. | Page | Ref. No. |
|-----------|------|----------|-----------|------|----------|-----------|------|----------|-----------|------|----------|
| 部品番号 | 頁 | 参照番号 | 部品番号 | 頁 | 参照番号 | 部品番号 | 頁 | 参照番号 | 部品番号 | 頁 | 参照番号 |
| 121 | 17 | 5 | 2913-1 | 9 | 22 | 167028 | 7 | 6 | 200400 | 7 | 14 |
| 126 | 17 | 6 | 2913-1 | 9 | 24 | 167029 | 7 | 7 | 200405 | 3 | 2 |
| 127 | 17 | 1 | 2913-1 | 9 | 28 | 167030 | 7 | 1 | 200406 | 5 | 1 |
| 128 | 17 | 2 | 2913-2 | 9 | 29 | 167031 | 9 | 21 | 200407 | 5 | 20 |
| 130 A-4 | 17 | 11 | 2913-2 | 15 | 4 | 167032 | 7 | 9 | 200408 | 15 | 35 |
| 130 A-6 | 17 | 10 | 2918 | 5 | 30 | 167033 | 9 | 27 | 200409 | 5 | 21 |
| 130 A-7 | 17 | 9 | 2918 | 15 | 18 | 167034 | 9 | 15 | 200410 | 5 | 23 |
| 130 A-9.5 | 17 | 8 | 2921 | 5 | 11 | 167035 | 9 | 17 | 200411 | 9 | 5 |
| 131 A | 17 | 7 | 2922 | 5 | 17 | 167036 | 9 | 18 | 200412 | 7 | 32 |
| 132 | 17 | 3 | 2924 | 7 | 2 | 167038-2 | 9 | 11 | 200413 | 3 | 3 |
| 1174 | 5 | 2 | 2924 | 9 | 4 | 167041 | 9 | 13 | 200414 | 3 | 1 |
| 1174 | 7 | 13 | 2928 | 7 | 10 | 167042 A | 9 | 7 | 200415 | 17 | 4 |
| 1174 | 7 | 21 | 2935 | 7 | 40 | 167043 | 9 | 10 | 200416 | 11 | 1 |
| 1174 | 7 | 30 | 2947 | 9 | 34 | 167045 | 9 | 3 | 200417 A | 11 | 10 |
| 1175-2 | 7 | 35 | 2948 | 9 | 36 | 167046 | 9 | 20 | 200419 | 9 | 35 |
| 1175-2 | 7 | 38 | 3018 | 7 | 5 | 167047 | 9 | 1 | 200425 | 9 | 8 |
| 1175-2 | 7 | 43 | 3018 | 7 | 15 | 167048 | 5 | 26 | 200488 | 11 | 19 |
| 1175-2 | 9 | 2 | 3018 | 15 | 29 | 167049 A | 5 | 27 | 200492 | 7 | 25 |
| 1175-2 | 13 | 9 | 3044 | 5 | 5 | 167050 | 5 | 29 | 200540 | 13 | 1 |
| 1175-2 | 15 | 31 | 3044 | 11 | 16 | 167050 | 15 | 17 | 200541 | 13 | 2 |
| 1196 | 3 | 4 | 3056 | 5 | 43 | 167052 | 5 | 31 | 200542 | 13 | 3 |
| 1196 | 5 | 34 | 3091 | 7 | 18 | 167054 | 5 | 33 | 200543 | 13 | 4 |
| 1196 | 13 | 6 | 3092 | 7 | 19 | 167055 | 5 | 35 | 200544 | 13 | 5 |
| 1196 | 15 | 20 | 3094 | 7 | 27 | 167056 | 9 | 25 | 200545 | 13 | 7 |
| 1202 | 13 | 16 | 5053 | 9 | 9 | 167058 | 7 | 37 | 200546 A | 13 | 8 |
| 1205 | 11 | 9 | 5059 | 15 | 22 | 167059 | 7 | 39 | 200547 | 13 | 10 |
| 1206 | 3 | 12 | 5060 | 15 | 2 | 167060 | 7 | 34 | 200548 | 13 | 13 |
| 1206 | 5 | 41 | 5060 | 15 | 23 | 167061 | 7 | 36 | 200549 | 13 | 15 |
| 1206 | 9 | 14 | 5060 | 15 | 38 | 167062 | 7 | 41 | 200550 | 13 | 17 |
| 1216 | 3 | 18 | 5067 | 9 | 19 | 167063 | 7 | 42 | 200551 | 13 | 18 |
| 1285 | 17 | 14 | 5099 | 11 | 20 | 167064 | 3 | 10 | 200552 | 15 | 1 |
| 1382 | 3 | 6 | 5124 | 5 | 4 | 167065 | 3 | 11 | 200553 | 15 | 3 |
| 1435 | 5 | 24 | 5142 | 11 | 14 | 167066 | 3 | 13 | 200554 | 15 | 5 |
| 1435 | 9 | 12 | 5148 | 15 | 9 | 167066 | 11 | 18 | 200555 | 15 | 6 |
| 1448 | 5 | 28 | 5148 | 15 | 11 | 167069 | 3 | 8 | 200556 | 15 | 7 |
| 1457 | 5 | 8 | 5148 | 15 | 14 | 167071 | 5 | 40 | 200557 | 15 | 8 |
| 1457 | 7 | 8 | 5148 | 15 | 40 | 167072 | 5 | 42 | 200558 | 15 | 10 |
| 1457-1 | 5 | 22 | 101111 | 5 | 46 | 167075 | 5 | 44 | 200559 | 15 | 12 |
| 1457-1 | 9 | 26 | 137106 | 5 | 47 | 167077 | 5 | 45 | 200560 | 15 | 13 |
| 1457-1 | 15 | 36 | 137123 | 5 | 7 | 167078 | 5 | 16 | 200561 | 15 | 15 |
| 1458 | 5 | 37 | 137147 | 11 | 12 | 167079 | 5 | 38 | 200562 | 15 | 19 |
| 1998 | 5 | 3 | 137420 | 15 | 25 | 167081 | 17 | 13 | 200563 | 15 | 21 |
| 1998-2 | 5 | 13 | 137441 | 15 | 27 | 167082 | 9 | 31 | 200564 | 15 | 24 |
| 2022 | 5 | 19 | 155124 | 5 | 12 | 168002 | 11 | 2 | 200565 | 15 | 26 |
| 2022 | 15 | 16 | 155138 | 17 | 12 | 168031 | 11 | 3 | 200566 | 15 | 30 |
| 2106 | 5 | 32 | 155141 | 11 | 7 | 168033 | 11 | 4 | 200567 | 15 | 32 |
| 2133 | 11 | 15 | 155148 | 5 | 36 | 168047 | 11 | 5 | 200568 | 15 | 37 |
| 2133-1 | 7 | 33 | 155160 | 11 | 8 | 168069 | 11 | 6 | 200569 | 15 | 39 |
| 2213-1 | 7 | 29 | 167002 | 3 | 5 | 168071 | 11 | 17 | 200570 | 13 | 11 |
| 2213-1 | 9 | 6 | 167003 | 9 | 33 | 200326 | 3 | 14 | 200571 | 13 | 12 |
| 2213-1 | 9 | 16 | 167008 | 5 | 18 | 200327 | 3 | 15 | 200572 | 13 | 19 |
| 2297 | 5 | 15 | 167009 | 5 | 14 | 200391 | 7 | 28 | 200574 | 13 | 20 |
| 2366 | 15 | 28 | 167011 | 5 | 6 | 200392 | 7 | 31 | 200575 | 15 | 33 |
| 2900-1 | 11 | 11 | 167012 | 5 | 9 | 200393 | 7 | 23 | 200576 | 15 | 34 |
| 2900-1 | 13 | 14 | 167013 | 5 | 10 | 200394 | 7 | 26 | 200582 | 3 | 17 |
| 2902 | 3 | 7 | 167014 | 9 | 30 | 200395 | 7 | 22 | 201167 A | 11 | 13 |
| 2902 | 7 | 11 | 167016 | 9 | 23 | 200396 | 7 | 20 | 201767 | 9 | 32 |
| 2905 | 3 | 9 | 167020 | 7 | 24 | 200397 | 7 | 12 | 202033 | 5 | 25 |
| 2905 | 5 | 39 | 167023 | 7 | 17 | 200398 | 7 | 16 | DMx13 #9 | 17 | 15 |
| 2906 | 3 | 16 | 167027 | 7 | 4 | 200399 | 7 | 3 | DMx13 #11 | 17 | 16 |
| | | | | | | | | | DMx13 #14 | 17 | 17 |

■ PEGASUS
SEWING MACHINE MFG.
CO., LTD.®

