

---

**PARTS LIST**

Dec. 1980

# **DV.DW**SERIES

**MODELS: DV.DW**

---

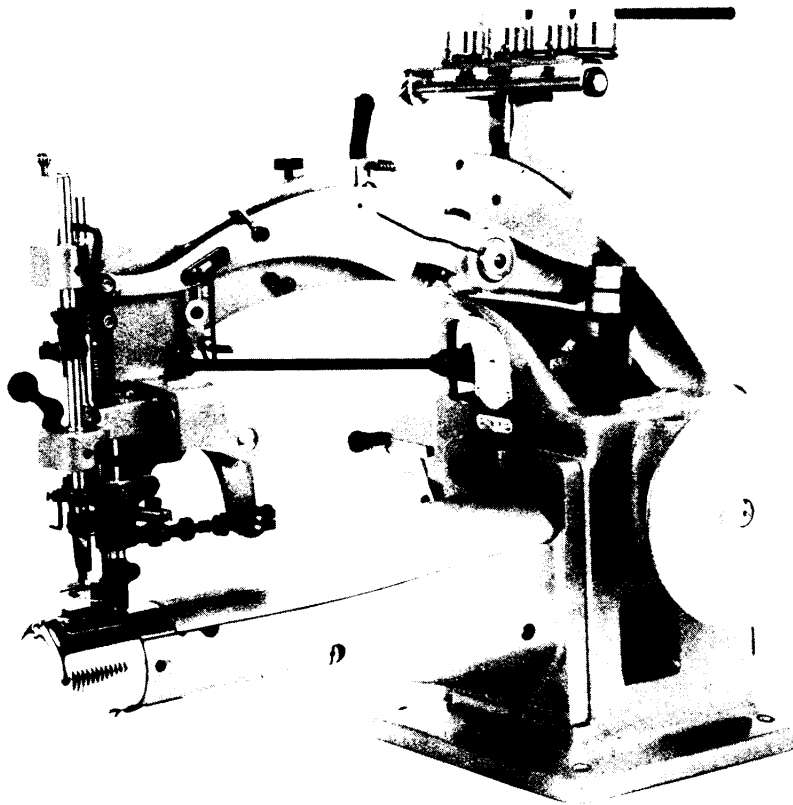

**PEGASUS<sup>®</sup>**



## IN ORDERING PARTS

This book has been arranged to simplify ordering repair parts for model DW-3, DW-7 and DV-1, on the basis of model DW-3.

Various sections of the mechanisms are shown on each page. On the page opposite the illustrations will be found a listing of the parts with their reference numbers, parts numbers, names and the number of pieces required.

Parts whose numbers are marked with an asterisk (\*), appeared in from page 3 to 17 except page 15, e.g. \*192138, Ref. No. 23, Page 3, are used for model DW-3 and DW-7 only, not for model DV-1. Parts used for model DV-1 only are illustrated and listed in page 18 and 19.

All the gauge parts such as needle clamp, needle plate, feed dog and presser foot for each model are illustrated and listed on the pages 20 and 21.

At the back of this list, a numerical index of all parts is shown. This will facilitate locating the illustrations and descriptions when only the part number is known.

In ordering parts from this list, the part number MUST be quoted exactly as it is shown in the second column on the page opposite the illustrations. Reference number should never be used in ordering parts.

## CONTENTS

MACHINE ARM-BED & COVERS .....	アーム・ベッド・外部機構 .....	2 ~ 3
MAIN SHAFT MECHANISM .....	主軸機構 .....	4 ~ 5
NEEDLE BAR DRIVE MECHANISM & THREAD PARTS .....	針棒機構 .....	6 ~ 7
LOOPER DRIVE MECHANISM .....	ルーバー機構 .....	8 ~ 9
FEED MECHANISM .....	送り機構 .....	10 ~ 11
PRESSER FOOT & LIFTING MECHANISM .....	押エ機構 .....	12 ~ 13
SPREADER DRIVE MECHANISM & THREAD PARTS .....	飾り振り機構 (DW-3、DW-7型専用) .....	14 ~ 15
(FOR MODEL DW-3 & DW-7 ONLY)		
LOOPER THREAD PARTS .....	裏糸調子機構 .....	16 ~ 17
PARTS FOR MODEL DV-1 ONLY .....	DV-1型専用部品 .....	18 ~ 19
LIST OF GAUGE PARTS .....	ゲージパーツ表 .....	20 ~ 21
ACCESSORIES .....	付属品 .....	22 ~ 23
NUMERICAL INDEX OF PARTS .....	部品番号索引 .....	24

## 部品表御利用に際して

本部品表はDW-3型を基本にDW-7、DV-1型ミシンの修理用部品を容易に御利用頂ける様編集されている。

機構別に各頁に収録され、部品図解頁(左開き)の反対頁(右開き)には参照番号、部品番号、名称、使用数量の順で記載されている。

3頁から17頁(15頁を除く)にわたり\*印の付された部品番号(例 参照番号23、3頁)はDW-3、DW-7型にのみ共通で、DV-1型には使用されない。DV-1型専用部品は18、19頁に収録されている。

全ての機種針抱、針板、送り歯、押エ等のゲージパーツは20頁、21頁のゲージパーツ表に収録されている。

本部品表の最終頁(24頁)には部品番号索引表を付し、部品番号のみでその図解、名称等が容易に引き出せる。

本部品表に基き部品御注文の際、参照番号は絶対に使用されず必ず部品番号のみを明示下さい。

本部品表は1970年11月現在製造中のDW/DV型ミシン用に作成されております。

## 目次

PAGE  
頁

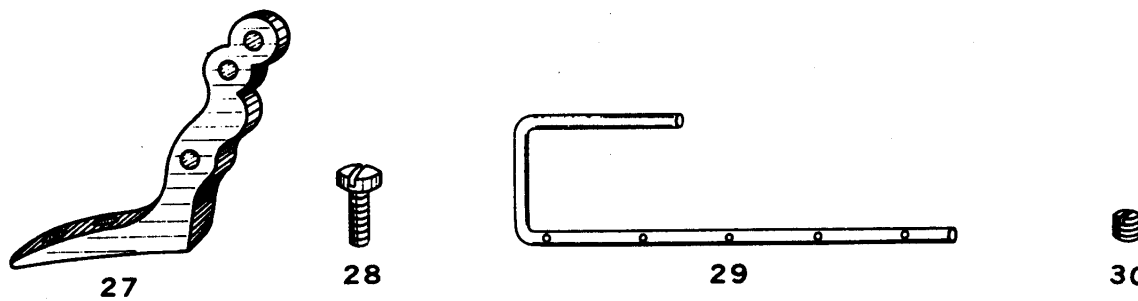
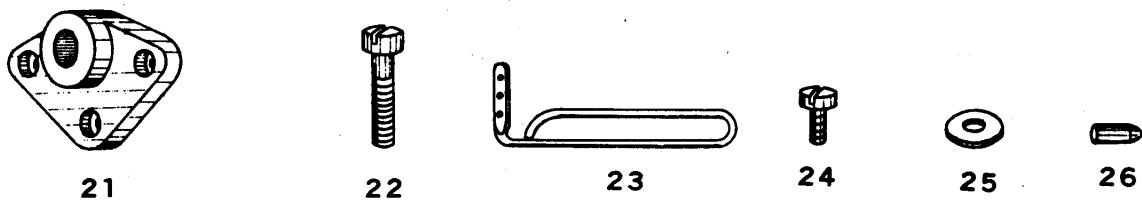
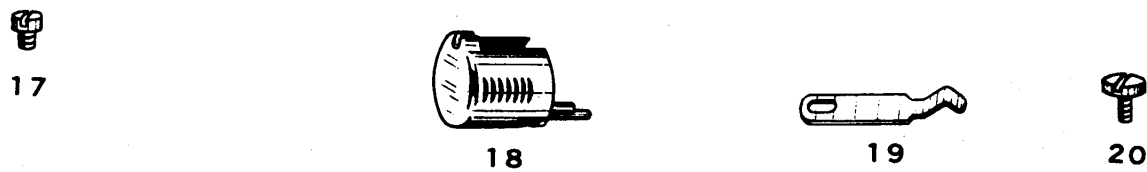
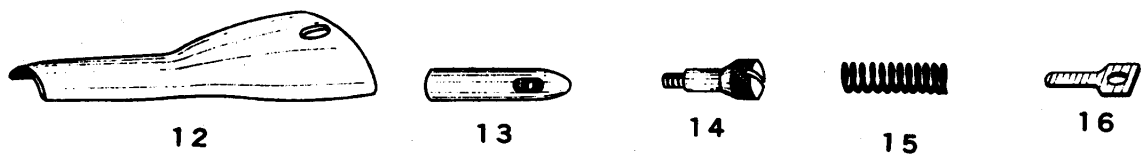
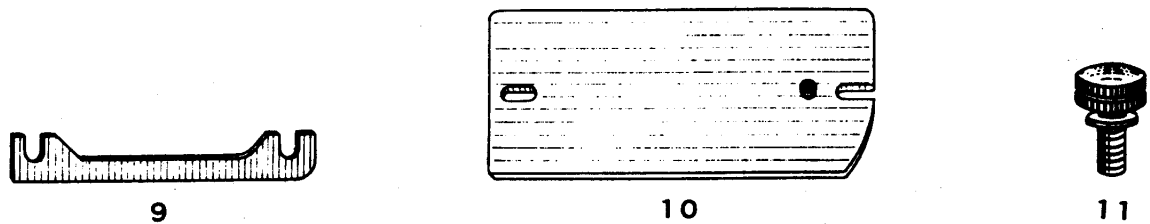
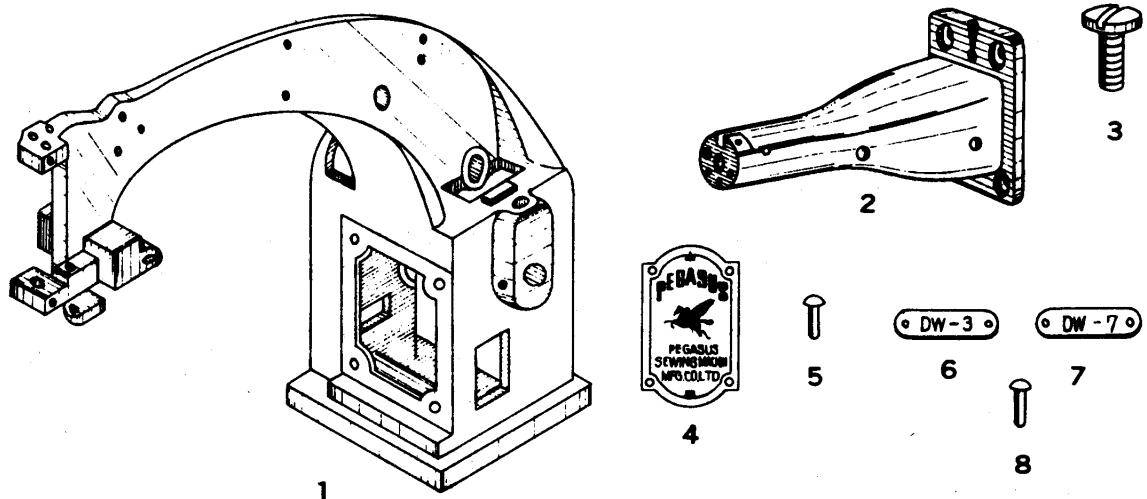

## MACHINE ARM-BED & COVERS

### アーム・ベッド・外部機構

Ref. No. 参照番号	Parts No. 部品番号	Name	名称	Qt. 数量
1	*192001	Machine arm	アーム ベッド	1
2	192002A	" cylinder bed	筒	1
3	5311	" " " screw	＊止ネジ	4
4	202046	Name plate	銘板	1
5	137011G	" " pin	＊止ピン	4
6	149038	Model plate, for model DW-3 only	型式板 (DW-3)	1
7	149039	" plate, for model DW-7 only	＊ (DW-7)	1
8	137011G	" plate pin	＊止ピン	2
9	200384	Machine cylinder bed shim	筒取付用鉄板	1
10	192128	" arm rear cover	後カバー	1
11	128-2	" " " " screw	＊止ネジ	2
12	192129 A	" cylinder bed cover	前カバー	1
13	192131	" " " " plunger	＊ピン	1
14	5337	" " " " " screw	＊＊引ネジ	1
15	192130	" " " " " spring	＊＊押バネ	1
16	192132	" " " " latch	＊前板バネ	1
17	132-1	" " " " " screw	＊＊止ネジ	1
18	191134A	Looper cover	ルーパーカバー	1
19	192133	" " latch	＊止板バネ	1
20	62-1	" " " " screw	＊＊止ネジ	1
21	192137	" shaft bushing	筒メタル	1
22	5310	" " " " screw	＊止ネジ	3
23	*192138	Needle thread guide	土台糸道	1
24	42-1	" " " " screw	＊止ネジ	1
25	137142	" " " " " washer	＊＊座金	1
26	198016	" " " " pin	＊止ピン	1
27	149027	Thread guide stand	L型糸道土台	1
28	144-2	" " " " screw	＊止ネジ	2
29	*192145A	" guide	L型糸道	1
30	11-1	" " " " screw	糸道棒止ネジ	1

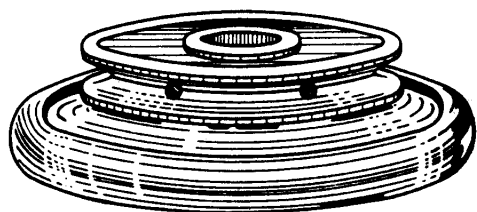

1



2



3

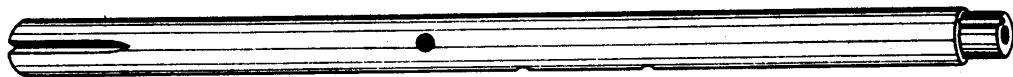

4

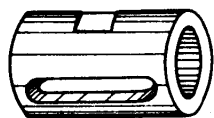

5



6



7



8

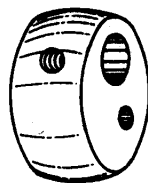

9



10



11

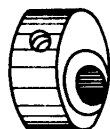

12



13

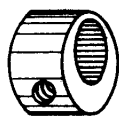

14



15

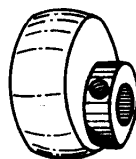

16



17



18

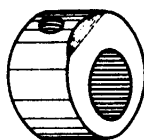

19



20

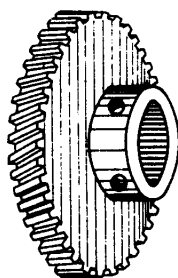

21



22

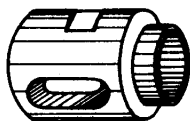

23



24



25



26

## MAIN SHAFT MECHANISM

### 主 軸 機 構

Ref. No. 参照番号	Parts No. 部品番号	Name	名 称	Qt. 数量
1	192003	Pulley	プーリー	1
2	3-1	" spot screw	＊ 止ネジ(先有)	1
3	3-2	" set screw	＊ ＊ (先無)	1
4	192004	Main shaft	主軸大シャフト	1
5	192005	" " bushing (right)	大シャフトブッシュ大	1
6	2022-3	" " " " screw	＊ 止ネジ	1
7	200493	" " " " oil wick	＊ 給油フェルト	1
8	200390	" " " " " hole wick	＊ ＊	2
9	192006	Needle bar drive eccentric	針棒上下ロッド球大	1
10	6-1	" " " " spot screw	＊ 止ネジ(先有)	1
11	6-2	" " " " set screw	＊ ＊ (先無)	1
12	192007	Feed rocker eccentric	送り変動ロッド球A(段付)	1
13	6-1	" " " " spot screw	＊ 止ネジ(先有)	1
14	192008	Looper lever eccentric	ルーバー前後ロッド球	1
15	8-1	" " " " spot screw	＊ 止ネジ(先有)	1
16	192009	" shaft rocker eccentric	ルーバーロッド球大	1
17	6-1	" " " " spot screw	＊ 止ネジ(先有)	1
18	6-2	" " " " set screw	＊ ＊ (先無)	1
19	192010	Feed lift eccentric	送り変動ロッド球B(段無)	1
20	6-1	" " " " spot screw	＊ 止ネジ(先有)	1
21	*193011	Spreader drive gear	片振り下ギヤー	1
22	11-1	" " " " screw	＊ 止ネジ	2
23	*192012	Main shaft bushing (left)	大シャフトブッシュ小(段付)	1
24	2022-3	" " " " screw	＊ 止ネジ	1
25	*200334	" " " " oil wick	＊ 給油フェルト	2
26	*202024	" " " " " hole wick	＊ 立油穴給油フェルト	1

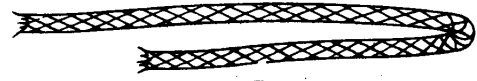
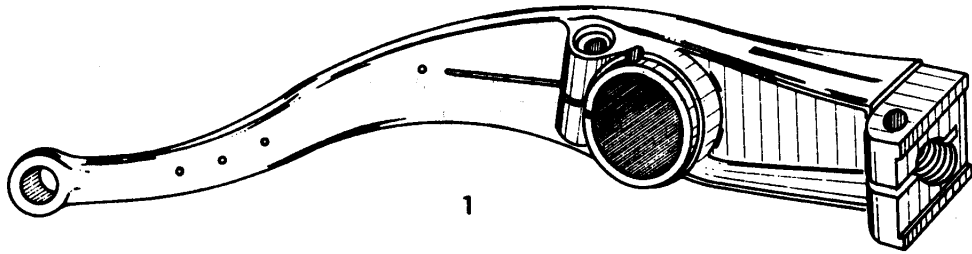

2



3

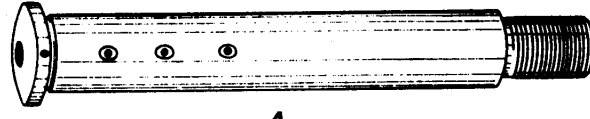

4



6



7

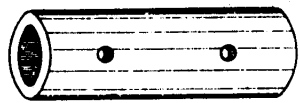

8



9



10

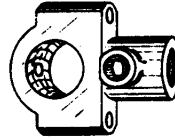

11



12



13

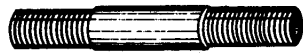

14



16



17

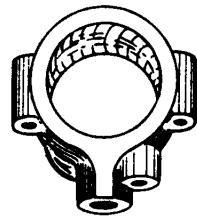

18



19



20



21



15



22



23



24



25

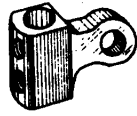

26



27



28



29



30



31

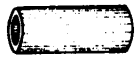

32



33



34



35

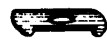

36



37



38



39



40



41



42



43

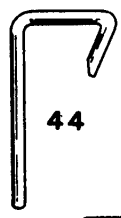

44



45



46



47



48



49



50



51



52



53



54



55



56



57



## NEEDLE BAR DRIVE MECHANISM & THREAD PARTS

### 針 棒 機 構

Ref. No. 参照番号	Parts No. 部品番号	Name	名 称	Qt. 数量	Remarks 備 考
1	200387	Needle bar drive arm	針棒クランク	1	
2	5307	" " " " clamp screw	締付ネジ	2	
3	5308	" " " " " " nut	ナット	2	
4	192055	" " " " stud	軸	1	
5	202175	" " " " " " oil wick	給油紐	1	
6	55-1	" " " " " " nut	ナット	1	
7	5306	" " " " " " oil plug screw	油穴蓋ネジ	1	
8	192056	" " " " " " collar	カラー	1	
9	192057	" " " " " " ball stud	針棒ロッド球小	1	
10	192058	" " " " " " guide	振り止メ	1	
11	192059	" " " " rod head (small)	針棒ロッド小	1	
12	59-1	" " " " " " cap screw	蓋止ネジ	2	
13	192059-1	" " " " " " oil cap	オイルカップ組	1	
14	192060	" " " " rod	針棒ロッド連結パイプ	1	
15	202175	" " " " " " oil wick	給油紐	1	
16	60-1	" " " " " " nut (right)	ナット右	1	
17	60-2	" " " " " " nut (left)	ナット左	1	
18	192061	" " " " " " head (large)	針棒ロッド大	1	
19	59-1	" " " " " " cap screw	蓋止ネジ	2	
20	200390	" " " " " " oil wick	給油フエルト	1	
21	200389	" " " " " " hole wick		1	
22	*192062	" " " " " " thread eyelet	針棒クランク糸道	1	
23	62-1	" " " " " " screw	止ネジ	1	
24	192064	" " " " " " thread eyelet	針棒糸道	1	
25	64-1	" " " " " " screw	止ネジ	1	
26	200388	" " " " clamp	針棒抱キ	1	
27	65-1	" " " " screw	止ネジ	3	
28	200653	" " " " drive link	針棒リンク	1	
29	200654	" " " " " " pin	ピン	2	
30	202175	" " " " " " oil wick	給油紐	2	
31	44-3	" " " " " " screw	止ネジ	1	
32	192068	" " " " bushing	針棒ブッシュ	2	
33	24-1	" " " " " " screw	止ネジ	2	
34	192069	" " " " thread nipper bracket	針棒糸調子台	1	
35	24-1	" " " " " " screw	止ネジ	1	
36	192070	" " " " nipper	糸調子皿	1	
37	198034	" " " " " " spring	バネ	1	
38	9070-2	" " " " " " stud screw	止ネジ	1	
39	*192071-3	" " " " clamp thread guide wire	針抱糸道	1	
40	* 71-4	" " " " " " screw	止ネジ	1	
41	200371	" " " " guard	針受	1	
42	200372	" " " " stud	軸	1	
43	6-2	" " " " " " screw	止ネジ	1	
44	191143	" " " " bar thread take-up wire	針棒糸掛	1	
45	143-1	" " " " " " screw	止ネジ	1	
46	71-1	" " " " clamp screw, for center needle	針抱止ネジ(先有)	1	
47	65-1	" " " " " " screw, for left & right needles	針抱止ネジ(先無)	2	
48	5373	" " " " plate screw	針板止ネジ	2	
49	192150	" " " " thread tension post (long)	針糸調子棒(長)	1	
50	192153A	" " " " " " spacer	パイプA	1	
51	192123	" " " " " " post (short)	棒(短)	2	1 pc. only for DW-7 & DV-1
52	192127A	" " " " " " spacer	パイプB	2	DW-7, DV-1は1ヶのみ
53	192152	" " " " " " spring	糸調子バネ(強)	3	
54	200361	" " " " " " guide	台	3	2 pcs. only for DW-7 & DV-1
55	5372	" " " " " " nut	ナット	3	DW-7, DV-1は2ヶのみ
56	192124	" " " " " " spring bushing	止パイプ	3	
57	192126	" " " " " " disc	皿	6	4 pcs. only for DW-7 & DV-1 DW-7, DV-1は4ヶのみ

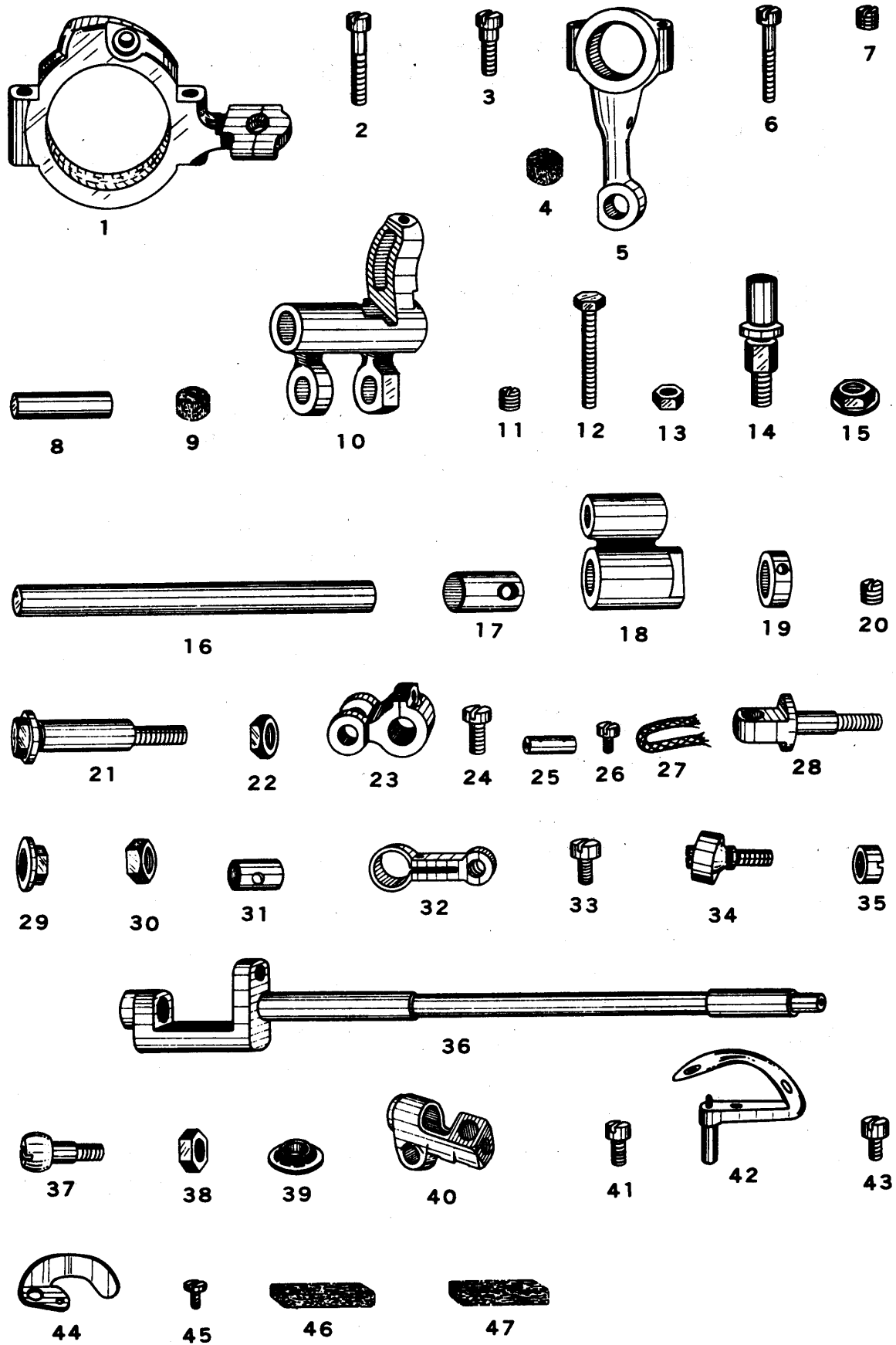

## LOOPER DRIVE MECHANISM

### ルーバー機構

Ref. No. 参照番号	Parts No. 部品番号	Name	名称	Qt. 数量
1	192032	Looper shaft rocker connection	ルーバー振りロッド	1
2	16-2	" " " " cap screw (long)	〃 蓋止ネジ(大)	2
3	5376	" " " " " screw (short)	〃 〃 (小)	2
4	200389	" " " " oil wick	〃 給油フェルト	2
5	192033	" lever connection	ルーバー前後ロッド	1
6	16-2	" " " cap screw	〃 蓋止ネジ	2
7	11-1	" " " set screw	〃 軸止ネジ	1
8	192029	" " " pin	〃 小軸	1
9	200389	" " " oil wick	〃 給油フェルト	1
10	192035	" lever	ルーバー前後調節器	1
11	11-1	" " screw	〃 止ネジ	2
12	35-2	" " lock screw	〃 押ネジ	1
13	35-3	" " " " nut	〃 〃 ナット	1
14	192036	" " stud	〃 ネジ	1
15	26-1	" " " nut	〃 〃 座付ナット	1
16	192037	" " shaft	〃 軸	1
17	192154	" " " bushing	〃 〃 ブッシュ	2
18	192038	" shaft rocker connection brace	ルーバーロッド振り止連結器	1
19	192040	" " " " " collar	〃 〃 軸カラー	3
20	11-1	" " " " " " screw	〃 〃 〃 〃 止ネジ	3
21	192041	" " " " " stud	〃 〃 連結六角ネジ	1
22	28-1	" " " " " " nut	〃 〃 〃 〃 ナット	1
23	200385	" lever link	ルーバー調節器リンク	1
24	42-1	" " " screw	〃 止ネジ	1
25	200654	" " " pin	〃 ピン	1
26	44-3	" " " " screw	〃 〃 止ネジ	1
27	202175	" " " " oil wick	〃 〃 給油紐	1
28	200386	" shaft rocker stud	ルーバー調節器長ネジ	1
29	26-1	" " " " nut	〃 〃 座付ナット	1
30	28-1	" " " " lock nut	〃 リンクピン長ネジナット	1
31	192045	" shaft rocker bushing	ルーバーシャフトブッシュ	1
32	192046	" " " connection link	ルーバーロッド振り止メ	1
33	5328	" " " " " screw	〃 〃 止ネジ	1
34	192047	" " " " ball stud	〃 球	1
35	47-1	" " " " " nut	〃 〃 ナット	1
36	192048	" shaft	ルーバーシャフト	1
37	192049	" " rocker ball	ルーバー振りロッド球小	1
38	28-1	" " " " nut	〃 〃 ナット	1
39	192050	" " " " collar	〃 〃 座金	1
40	192051	" holder	ルーバー台	1
41	51-1	" " screw	〃 止ネジ	1
42	*192052	Looper	ルーバー	1
43	51-2	" screw	〃 止ネジ	1
44	192053	" guard	〃 補助器	1
45	1231	" " screw	〃 〃 止ネジ	1
46	202473	" lever shaft bushing oil wick	ルーバー前後調節器軸ブッシュ給油フェルト	2
47	202473	" shaft bushing oil wick	筒前後メタル給油フェルト	2

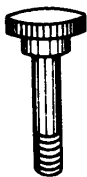
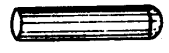
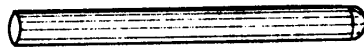
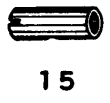
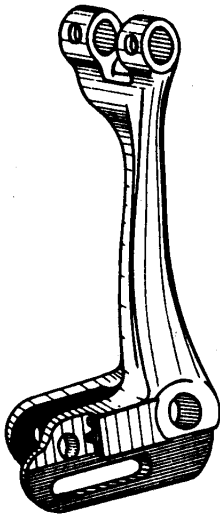
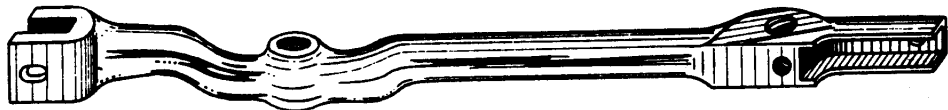
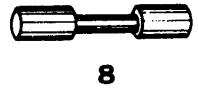
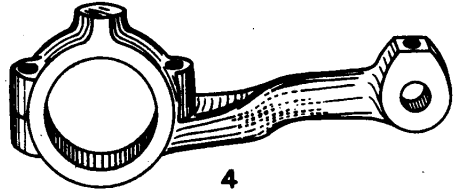
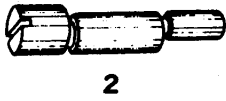
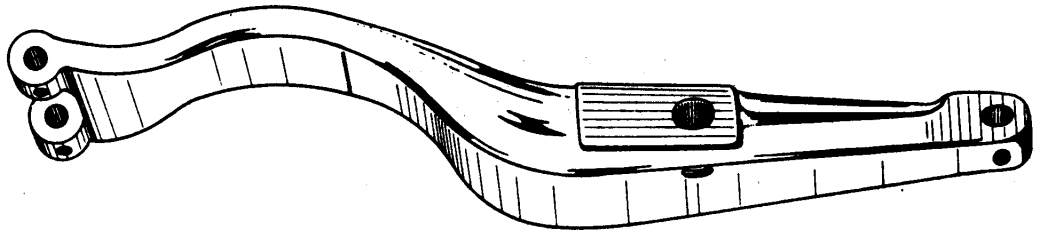

24

25

26

## FEED MECHANISM

### 送 り 機 構

Ref. No. 参照番号	Parts No. 部品番号	Name	名 称	Qt. 数量
1	192013	Feed lift lever	送り上下台	1
2	192014	" dog vertical adjusting pin	送り上下エキセン軸	1
3	14-1	" " " " " screw	止ネジ	2
4	192016	" lift lever & rocker connection	送り変動ロッド	2
5	11-1	" " " " " " pin screw	ピン止ネジ	2
6	16-2	" " " " " " cap screw	蓋止ネジ	4
7	200390	" " " " " " oil wick	給油フェルト	2
8	192017	" bar guide pin	送り台連結軸	1
9	192018	" bar	送り台	1
10	192028	" " link stud	止ネジ	1
11	28-1	" " " " nut	ナット	1
12	192019	" lift lever link pin	連結チエン芯ネジ	2
13	192020	" " " link (right)	(B)	1
14	192021	" " " link (left)	(A)	1
15	192015	" " " " bushing	送り上下台ブッシュ	2
16	192022	" rocker	送り調節器	1
17	192023	" " shaft	軸	1
18	14-1	" " " screw	止ネジ	1
19	192029	" " connection pin	小軸	2
20	192024	" " shaft collar	軸カラー	2
21	24-1	" " " " " screw	止ネジ	2
22	192025	" bar link	送り調節桿	1
23	192027	" " " bushing	カラー	2
24	192026	Stitch regulating stud	送り調節段ネジ	1
25	26-1	" " " nut	座付ナット	1
26	30-1	Feed dog screw	送り歯止ネジ	2

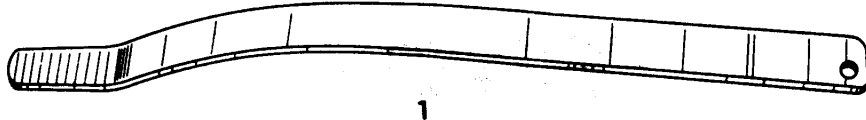

1



2

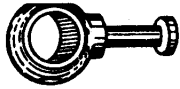

3



4

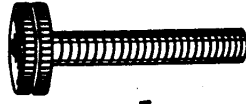

5



6

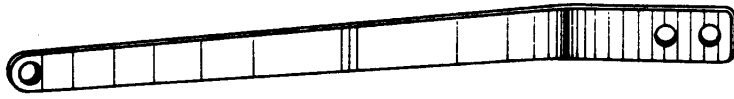

7



8

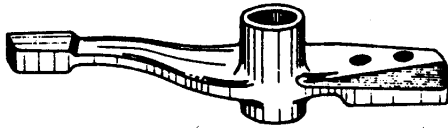

9

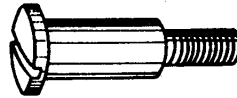

10



11

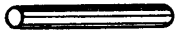

12



13

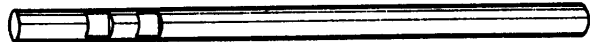

14



15



16

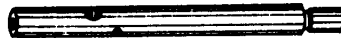

17



18

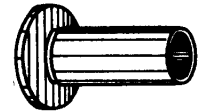

19



20



21

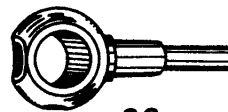

22



23



24

**PRESSER FOOT & LIFTING MECHANISM**

**押 工 機 構**

Ref. No. 参照番号	Parts No. 部品番号	Name	名称	Qt. 数量
1	192072	Presser spring	押エ板バネ	1
2	192072-1	" " pin	＊ ビン	1
3	192077	" " rest	＊ 受	1
4	24-1	" " " screw	＊ ＊止ネジ	1
5	192083	" " adjusting screw	＊ 押シネジ	1
6	83-1	" " " " lock nut	＊ ＊ ナット	1
7	192073	Foot lift lever extension	押エ上板金	1
8	42-1	" " " " screw	＊ 止ネジ	2
9	192074	" " lever	押エ上クランク	1
10	192075	" " " stud	＊ 殺ネジ	1
11	192081	" " " spring	＊ 引バネ	1
12	192081-1	" " " stop pin	＊ ＊ 当リピン	1
13	192081-2	" " " spring pin	＊ ＊ 引ピン	1
14	192076B	Presser guide bar	押エ上棒	1
15	200443	" " " stop collar	押エ上ゲストッパーカラー	1
16	24-1	" " " " " screw	＊ 止ネジ	2
17	*192079	" bar	押エ棒	1
18	44-3	" " connection screw	＊ 止ネジ	1
19	*193080	" " bushing	片振り押エ棒ブッシュ下	1
20	106-2	" " " clamp screw	＊ 止ネジ	1
21	192079-2	" " retaining ring	押エ棒金輪	1
22	192078	" " connection	＊ 抱キ	1
23	24-1	" " " screw	＊ ＊ 止ネジ	1
24	5328	" foot screw	押エ止ネジ	1

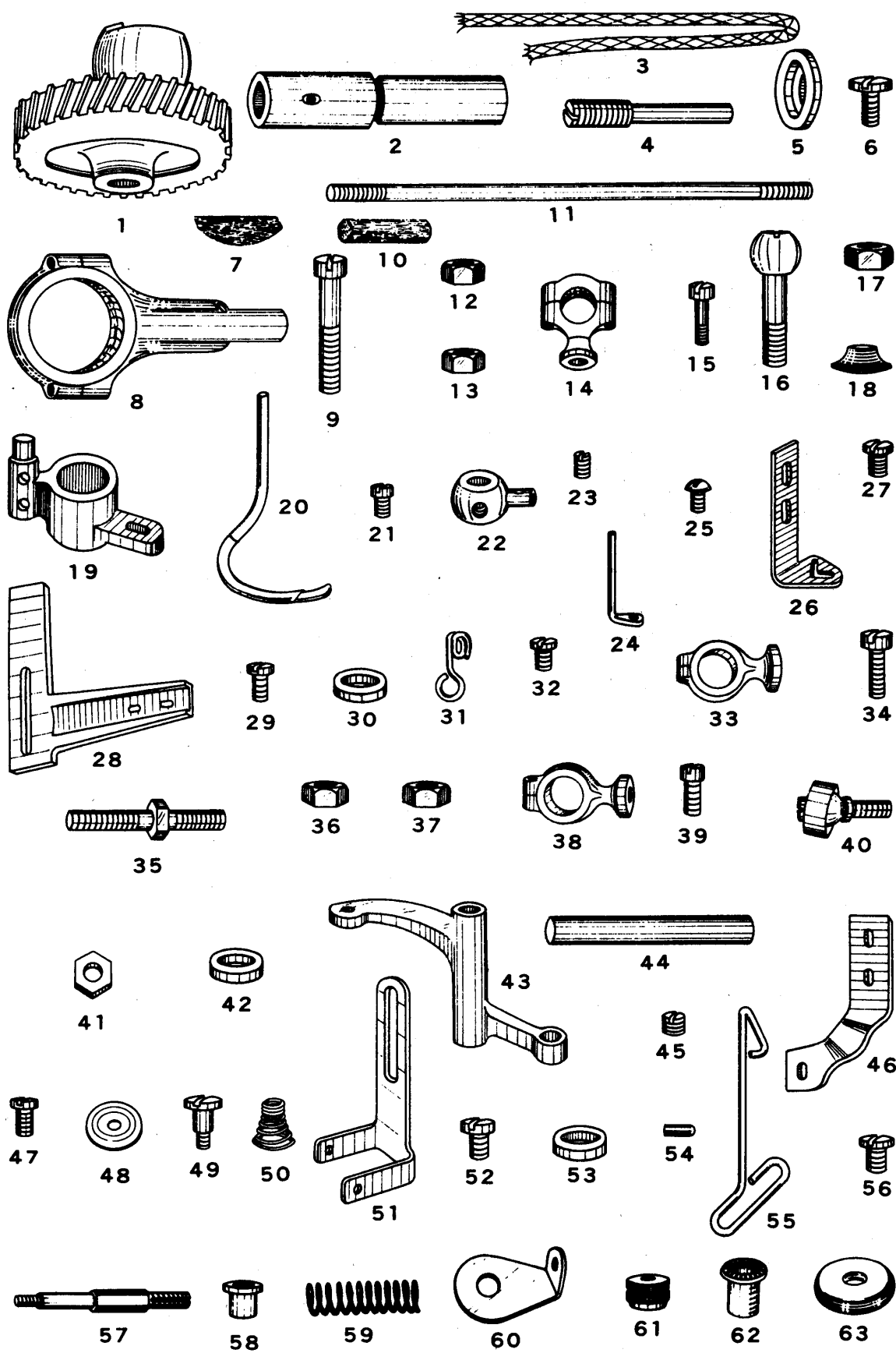



**SPREADER DRIVE MECHANISM & THREAD PARTS (FOR MODEL DW-3 & DW-7 ONLY)**

**飾り振り機構 (DW-3, DW-7 型専用)**

Ref. No. 参照番号	Parts No. 部品番号	Name	名称	Qt. 数量
1	193085	Spreader drive gear	片振り上ギヤ	1
2	192086	" " " shaft	上ギヤ軸	1
3	202175	" " " " oil wick	〃 〃 給油紐	1
4	5309	" " " " screw	〃 〃 止ネジ	1
5	192087	" " " " washer	〃 〃 頭座金	1
6	87-1	" " " " screw	〃 〃 止ネジ	1
7	200492	" " " shaft oil wick	〃 〃 軸給油フェルト	1
8	192088	connecting rod head (large)	飾り振りロッド	1
9	16-2	" " " " " cap screw	〃 〃 蓋止ネジ	2
10	201767	" " " " " oil wick	〃 〃 給油フェルト	1
11	192089	" " " rod	〃 〃 引棒	1
12	89-1	" " " " " nut (left)	〃 〃 ナット左	1
13	28-1	" " " " " (right)	〃 〃 ナット右	1
14	192090	connection rod head (small)	飾り振りロッド小	1
15	5376	" " " " " cap screw	〃 〃 蓋止ネジ	2
16	192091	" " " " " ball stud	〃 〃 球	1
17	28-1	" " " " " " " nut	〃 〃 ナット	1
18	192092	" " " " " " " washer	〃 〃 座金	1
19	193095	" " " carrier	片振り台	1
20	193098	Spreader (cover thread finger)	片振り	1
21	44-3	" " " screw	〃 〃 止ネジ	2
22	193170	thread eyelet holder	〃 〃 針棒糸道台	1
23	65-1	" " " " " screw	〃 〃 〃 止ネジ	1
24	193171	" " " eyelet	〃 〃 第一糸道	1
25	1333	" " " " " screw	〃 〃 〃 止ネジ	1
26	193173	" " " guide	〃 〃 糸道	1
27	64-1	" " " " " screw	〃 〃 〃 止ネジ	2
28	193172	" " " " " bracket	〃 〃 〃 台	1
29	1175-2	" " " " " " " screw	〃 〃 〃 〃 止ネジ	2
30	167061	" " " " " " " washer	〃 〃 〃 〃 座金	2
31	193174	" " " eyelet	〃 〃 第二糸道	1
32	1175-2	" " " " " screw	〃 〃 〃 止ネジ	1
33	192100	carrier connection head (right)	飾り振り台連結ロッド右	1
34	1175-2	" " " " " " " screw	〃 〃 〃 止ネジ	1
35	192102	" " " connecting rod	飾り振りロッド連結棒	1
36	102-1	" " " " " " " nut (right)	〃 〃 ナット右	1
37	102-2	" " " " " " " (left)	〃 〃 ナット左	1
38	192103	carrier connection head (left)	飾り振りロッド左	1
39	46-1	" " " " " " " screw	〃 〃 〃 止ネジ	1
40	192104	" " " connecting rod ball stud	飾り振りロッド球足長	2
41	35-3	" " " " " " " nut	片振りロッド下球ナット	1
42	167061	" " " " " " " washer	〃 〃 〃 〃 座金	1
43	193093	" " " rocker	片振り連結台二又	1
44	192105	" " " shaft	飾り振りロッド連結二又軸	1
45	11-1	" " " " " screw	〃 〃 〃 止ネジ	2
46	193175	thread nipper tension bracket	片振り小調子台	1
47	1175-2	" " " " " " " screw	〃 〃 〃 止ネジ	2
48	137108	" " " " " " " disc	〃 〃 皿	2
49	1092	" " " " " " " stud screw	〃 〃 〃 止ネジ	1
50	137109	" " " " " " " spring	〃 〃 〃 バネ	1
51	193179	" " " take-up eyelet	片振り二又糸道	1
52	1175-2	" " " " " " " screw	〃 〃 〃 止ネジ	1
53	137142	" " " " " " " washer	〃 〃 〃 〃 座金	1
54	193179-2	" " " " " " " guide pin	〃 〃 〃 案内ピン	1
55	193180	" " " take-up	片振り腕糸道	1
56	62-1	" " " " " " " screw	〃 〃 〃 止ネジ	2
57	192123	" " " tension post	飾り糸調子棒(短)	1
58	192127A	" " " " " " " spring spacer	〃 〃 バイブB	1
59	192148	" " " " " " " spring	〃 〃 バネ(中)	1
60	200361	" " " " " " " guide	〃 〃 〃 台	1
61	5372	" " " " " " " nut	〃 〃 ナット	1
62	192124	" " " " " " " spring bushing	〃 〃 〃 止バイブ	1
63	192126	" " " " " " " disc	〃 〃 〃 皿	2

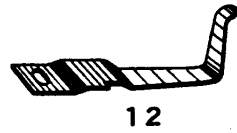
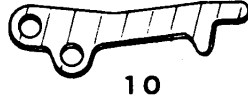
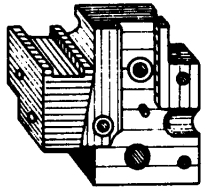
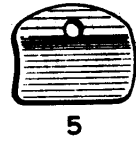
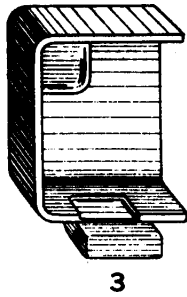
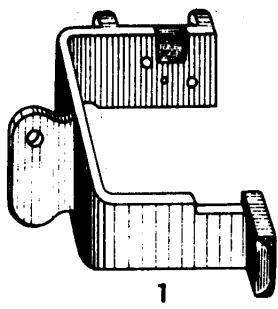

8

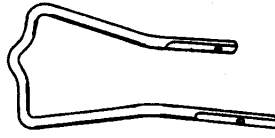
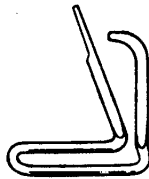

14

15

16

18

20

21

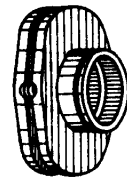

22

23

24

25

26

27

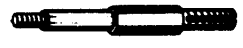
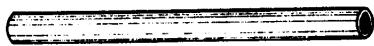

28

29

30

31

32

33

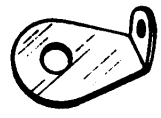

34

35

36

37

38

39



40

41

## LOOPER THREAD PARTS

### 裏糸調子機構

Ref. No. 参照番号	Parts No. 部品番号	Name	名称	Qt. 数量
1	192107 A	Looper thread take-up cover bracket	裏糸道カバー	1
2	107-1	" " " " " screw	止ネジ	2
3	192108	" " " cover	蓋	1
4	107-2	" " " " hinge pin	クビンネジ	1
5	192109	" " " " latch	板バネ	1
6	1175-2	" " " " " screw	止ネジ	1
7	167061	" " " " " washer	座金	1
8	192110	" " " control bracket	下糸調子取付台	1
9	5328	" " " " " screw	止ネジ	2
10	192111	" " " " finger	下糸弛メ	1
11	5328	" " " " " screw	止ネジ	2
12	192112	" " " nipper spring (upper)	下糸調節板バネ上	1
13	1175-2	" " " " " screw	止ネジ	1
14	167063	" " " " (lower)	下	1
15	192114	" " " " cast-off wire	下糸捌キ	1
16	5373	" " " " " screw	止ネジ	1
17	192114-2	" " " " " pin	止ピン	1
18	192116	" " " take-up eyelet	下糸二又糸道	1
19	192115	" " " " " spring	押エバネ	1
20	42-1	" " " " " screw	止ネジ	1
21	1170-3	" " " " " stop screw	当リネジ	1
22	44-3	" " " " " stop lock screw	止ネジ	1
23	192117	" " " controller cam	下糸調節器小	1
24	5373	" " " " " screw	止ネジ	1
25	192118	" " " nipper spring cam	中	1
26	192119	" " " take-up	大	1
27	65-1	" " " " screw	止ネジ	1
28	192120	" " " tube	下糸道パイプ	1
29	198177	" " " " clamp	止金	1
30	30-1	" " " " " screw	止ネジ	1
31	192121	" " " eyelet	筒中糸道	1
32	62-1	" " " " screw	止ネジ	1
33	192123	" " " tension post	下糸調子芯棒	1
34	5372	" " " " nut	ナット	1
35	192124	" " " " spring bushing	止パイプ	1
36	192125	" " " " spring	バネ(細)	1
37	192126	" " " " disc	皿	2
38	192127 A	" " " " post spacer	棒パイプB	1
39	202849	" " " " guide	台	1
40	192122	" " " " guide wire	筒前糸道	1
41	62-1	" " " " " screw	止ネジ	1

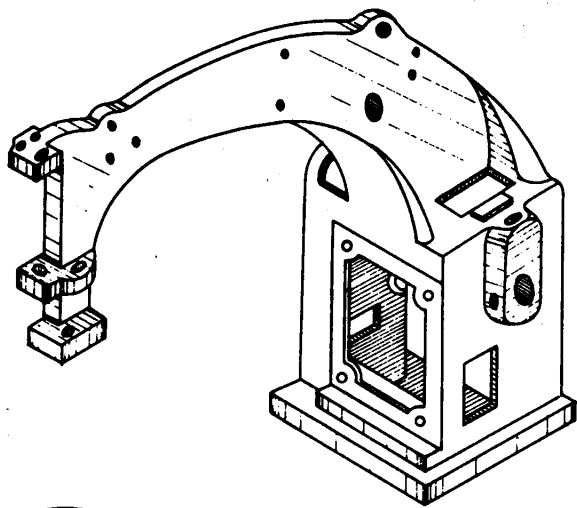

• DV-1 •  
2



3



4



5



6

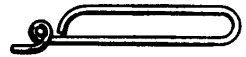

7

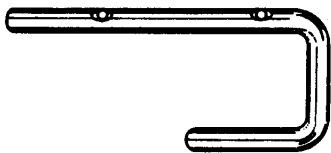

8

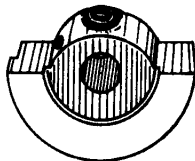

9



10



11



12



13

**PARTS FOR MODEL DV-1 ONLY**

**DV-1型専用部品**

<u>Ref. No.</u> 参照番号	<u>Parts No.</u> 部品番号	<u>Name</u>	<u>名称</u>	<u>Qt.</u> 数量
1	191001	Machine arm	アーム	1
2	200370	Model plate	型式板	1
3	191012	Main shaft bushing (left)	大シャフトブッシュ小(段付)	1
4	200493	" " " " oil wick	" " " 給油フェルト	1
5	191052	Looper	ルーパー	1
6	191079	Presser bar	押工棒	1
7	191138	Needle thread eyelet	土台糸道	1
8	191145A	Thread guide	L型糸道	1
9	191011	Main shaft counter balance	モーション	1
10	6-1	" " " " spot screw	" 止ネジ(先有)	1
11	14-1	" " " " set screw	" " (先無)	1
12	191154	Needle thread take-up eyelet	針棒クランク巻糸道	1
13	62-1	" " " " screw	" 止ネジ	1

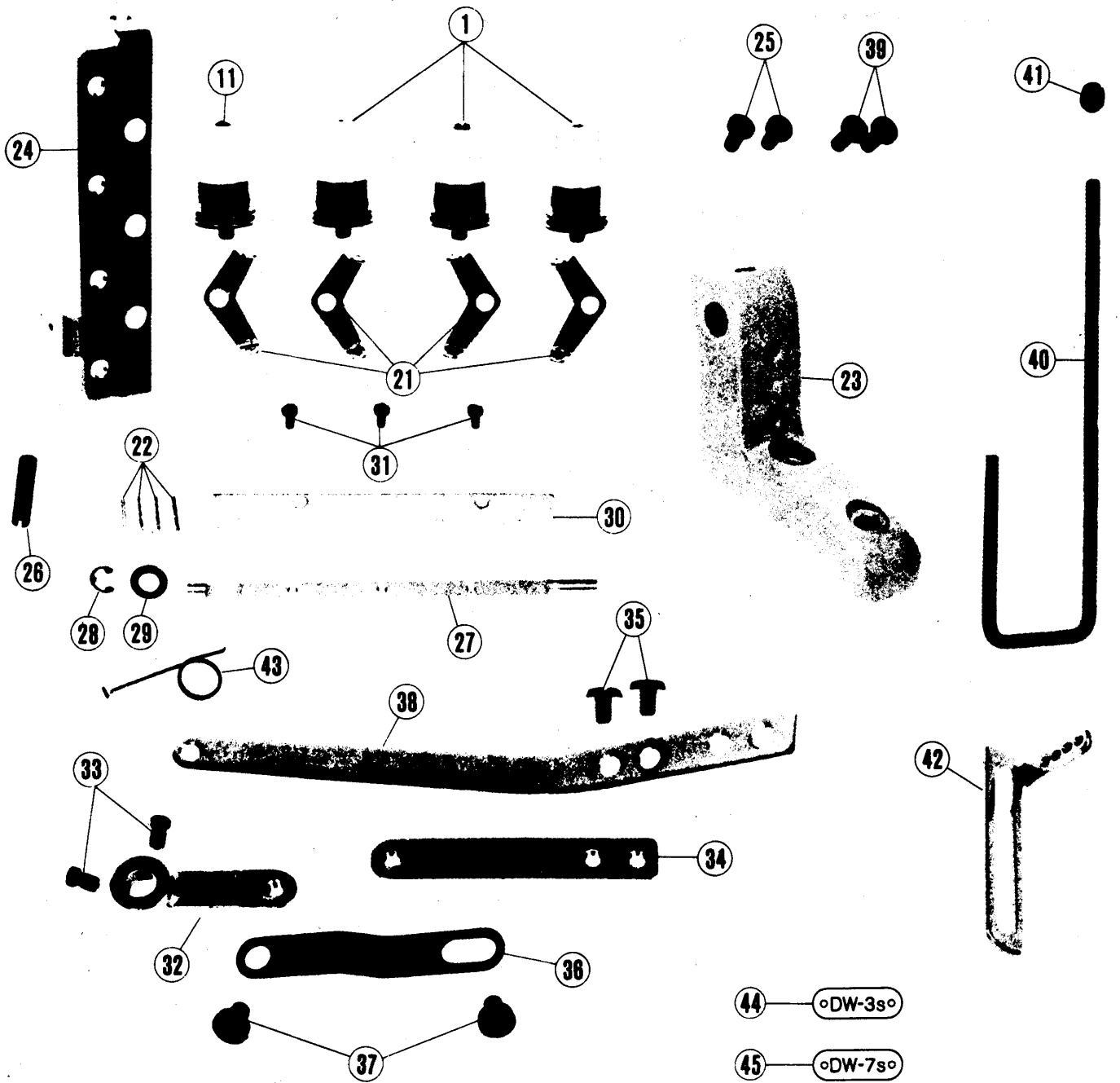
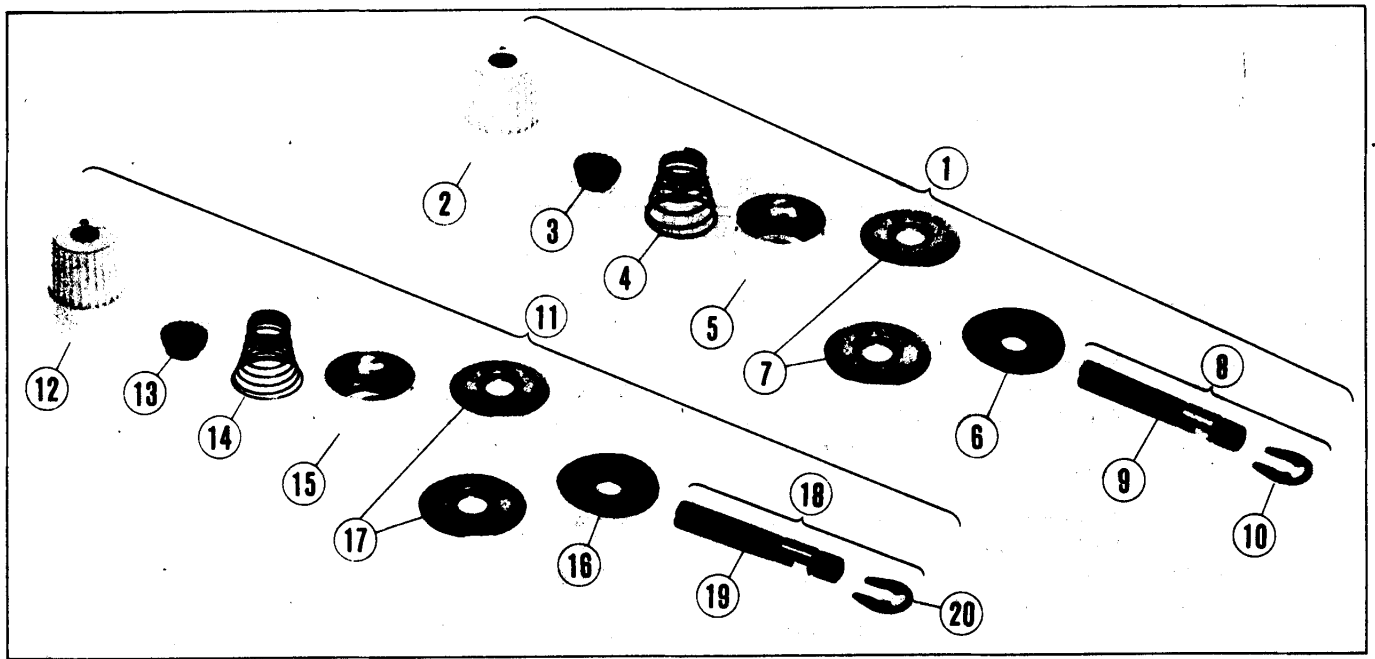

## DW-3s and DW-7s SPECIFIC PARTS

### DW-3s・DW-7s専用

Ref. No. 参照番号	Parts No. 部品番号	Name	名称	Qt. 数量	Remarks 備考
1	207110	Needle thread tension complete	針糸調子(組)	3	Complete with Ref. No. 2~8 参照番号2~8ノ組
2	208447	Tension nut	調子ナット	3	
3	208448	Pipe	パイプ	3	
4	201037	Tension spring (heavy)	圧縮バネ(強)	3	
5	306359	Cup	受皿	3	
6	208449	Felt	フェルト	3	
7	210319	Disc	皿	6	
8	306306	Post complete	段付ネジ(組)	3	Complete with Ref. No. 9~10 参照番号9~10ノ組
9	306307	Post	段付ネジ	3	
10	200983	Retaining ring	止メ輪	3	
11	207112	Spreader thread tension complete	飾り糸調子(組)	1	Complete with Ref. No. 12~18 参照番号12~18ノ組
12	208447	Tension nut	調子ナット	1	
13	208448	Pipe	パイプ	1	
14	201068	Tension spring (light)	圧縮バネ(弱)	1	
15	306359	Cup	受皿	1	
16	208449	Felt	フェルト	1	
17	210319	Disc	皿	2	
18	306306	Post complete	段付ネジ(組)	1	Complete with Ref. No. 19~20 参照番号19~20ノ組
19	306307	Post	段付ネジ	1	
20	200983	Retaining ring	止メ輪	1	
21	207183	Thread guide	糸道	4	
22	149029	Pin	平行ピン	4	
23	149027-ED	Thread tension bracket base	糸調子台ブラケット	1	
24	149028	Thread tension bracket	糸調子台	1	
25	5117	Screw	" 止ネジ	2	
26	201291	Pin	スプリングピン	1	
27	149030	Thread tension release shaft	糸弛メ軸	1	
28	202522	Ring	" 止メ輪	1	
29	202868	Washer	" 座金	1	
30	149031	Thread tension release plate	糸弛メ押し板	1	
31	1189	Screw	" " 止ネジ	3	
32	149032	Upper lever	糸弛メレバー(上)	1	
33	5084	Screw	" " 止ネジ	2	
34	149033	Lower lever	糸弛メレバー(下)	1	
35	5214	Screw	" " 止ネジ	2	
36	206157	Link	糸弛メリンク	1	
37	5386	Screw	" " 止ネジ	2	
38	192073	Foot lift lever	押エ足揚レバー	1	
39	42-1	Screw	" " 止ネジ	2	
40	192145A	Thread guide bar	糸道棒	1	
41	5234	Screw	" 止ネジ	1	
42	149034	Thread guide	糸道	1	
43	149035	Spring	ネジリバネ	1	
44	149038	Type plate for model DW-3s	型式板(DW-3s)	1	
45	149039	Type plate for model DW-7s	" (DW-7s)	1	
46	149036Z	Tension releacer complete DW-3s	糸弛メ装置一式(DW-3s用)	1	参照番号1, 11, 21~43ノ組
47	149037Z	Tension releacer complete DW-7s	糸弛メ装置一式(DW-7s用)	1	参照番号1, 21~43ノ組

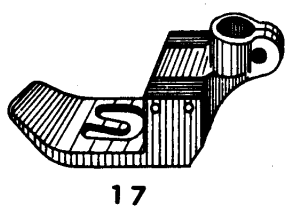
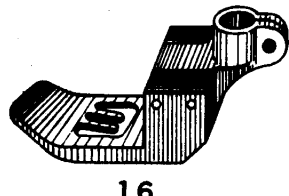
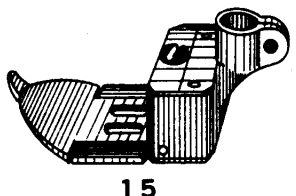
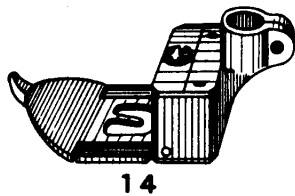
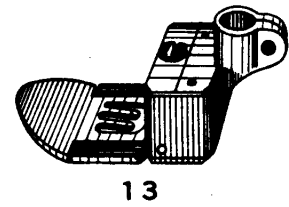
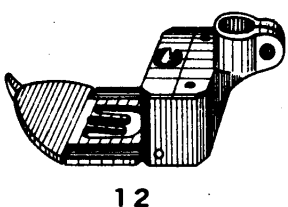
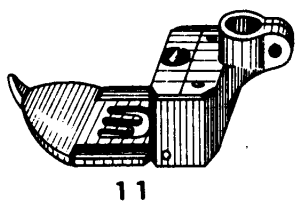
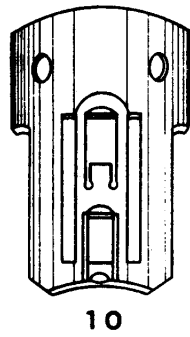
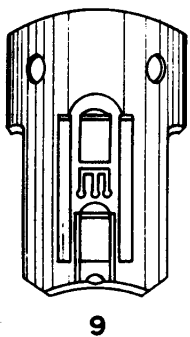
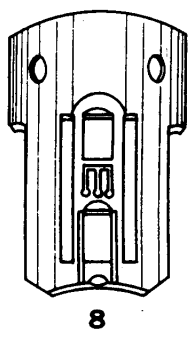
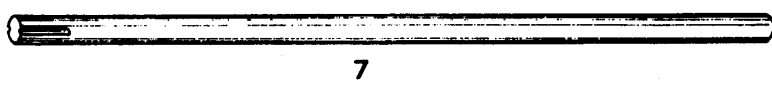
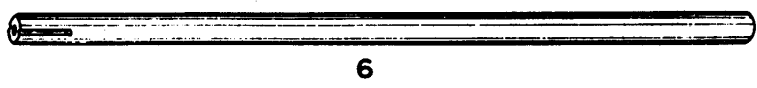
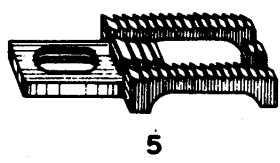
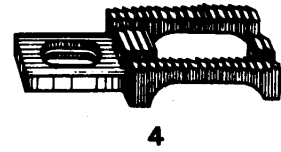
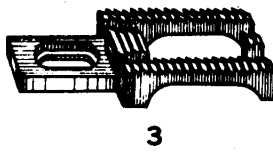



LIST OF GAUGE PARTS  
ゲージパーツ表

Model	Needle gauge	Ref. No.	Needle clamp	Ref. No.	Feed dog	Ref. No.	Needle bar	Ref. No.	Needle plate	Ref. No.	Presser foot (solid)	Ref. No.	Presser foot (hinged)	Remarks
機種	針巾	参照番号	針抱	参照番号	送り曲	参照番号	針棒	参照番号	針板	参照番号	昇工(固定)	参照番号	昇工(自由)	備考
D W-3	5.5mm	1	192071	3	200478	6	192063	8	200475	11	* 200483	16	200585	Standard model (標準型)
										12	** 200482			
	5.5mm	1	192071	4	200477	6	192063	9	*** 200479	13	*** 193084	16	200585	
D W-7	3.2mm	1	192071	5	200442	7	200359	10	200444	14	200451	17	200587	
	4.0mm	1	192071	5	200442	7	200360	10	200445	14	200452	17	200586	Standard model (標準型)
D V-1	5.0mm	2	191071A	5	200442	7	191063	10	191031	15	191084			Standard model (標準型)
	6.35mm	2	191071A	5	200450	7	200449	10	200446	15	200440			

\* 200483.....Chaining-off fingers are of unequal length. (爪差付)  
 \*\* 200482.....Chaining-off fingers are of equal length. (爪差無)  
 \*\*\* 200479.....Without guide tips. (案内金無)  
 \*\*\*\* 193084.....Without guide tip. (案内金無)



1



2

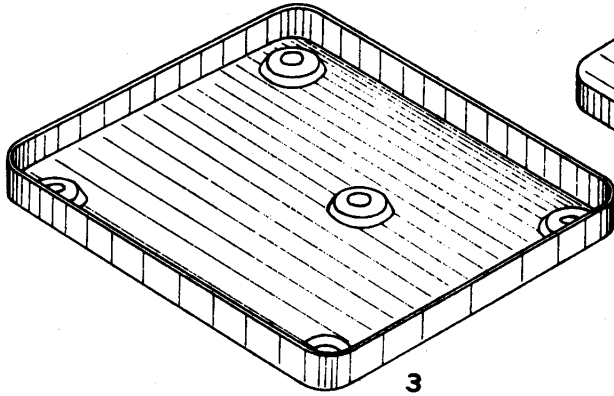

3

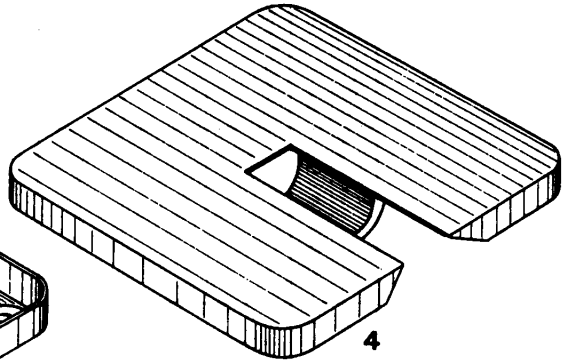

4

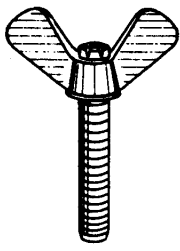

5

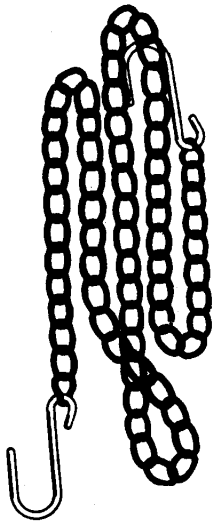

6



7

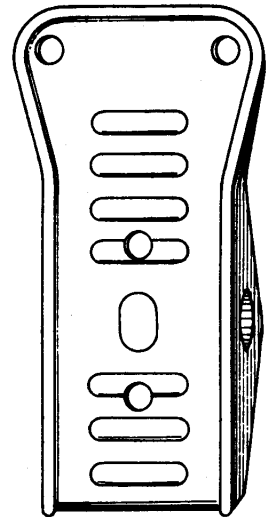

8



9



10

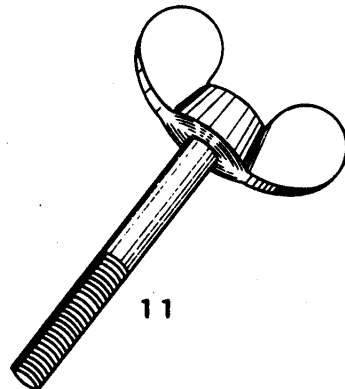

11

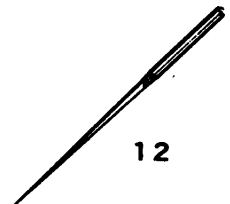

12

**ACCESSORIES**

**付 属 品**

Ref. No. 参照番号	Parts No. 部品番号	Name	名 称	Qt. 数量
1	127	Screw driver (large)	ドライバー(大)	1
2	128	" driver (medium)	〃 (中)	1
3	200486	Oil pan	オイルパン	1
4	191155	Auxiliary plate	差し板	1
5	206	" " thumb screw	〃 蝶ボルト	1
<hr/>				
6	126	Treadle chain	クサリ	1
7	132	Oiler (containing 50cc oil)	油差シ(50cc入り)	1
8	121	Treadle	靴(組)	1
9	130A-9.5	Combination wrench (9.5mm)	スパナ(9.5mm)	1
10	131A	Tweezers	ピンセット	1
<hr/>				
11	9207	Machine thumb screw	蝶ネジ	1
12	DVx1	Needle (DVx1 #11)	針(DVx1 #11)	10

NUMERICAL INDEX OF PARTS

部品番号索引

Parts No. Page Ref. No.	Parts No. Page Ref. No.	Parts No. Page Ref. No.	Parts No. Page Ref. No.	Parts No. Page Ref. No.
部品番号 頁 参照番号	部品番号 頁 参照番号	部品番号 頁 参照番号	部品番号 頁 参照番号	部品番号 頁 参照番号
3-1 5 2	62-1 3 20	191079 19 6	192073 13 7	193095 15 19
3-2 5 3	62-1 7 23	191084 21 15	192074 13 9	193098 15 20
6-1 5 10	62-1 15 32	191134 A 3 18	192075 13 10	193170 15 22
6-1 5 13	62-1 15 47	191138 19 7	192076 B 13 14	193171 15 24
6-1 5 17	62-1 15 56	191143 7 44	192077 13 3	193172 15 28
6-1 5 20	62-1 17 32	191145 A 19 8	192078 13 22	193173 15 26
6-1 19 10	62-1 17 41	191154 19 12	192079 13 17	193174 15 31
6-2 5 11	62-1 19 13	191155 23 4	192079-2 13 21	193175 15 46
6-2 5 18	64-1 7 25	192001 3 1	192081 13 11	193179 15 51
6-2 7 43	64-1 15 27	192002 A 3 2	192081-1 13 12	193179-2 15 54
8-1 5 15	65-1 7 27	192003 5 1	192081-2 13 13	193180 15 55
11-1 3 30	65-1 7 47	192004 5 4	192083 13 5	200334 5 25
11-1 5 22	65-1 15 23	192005 5 5	192086 15 2	200356 3 6
11-1 9 7	65-1 17 27	192006 5 9	192087 15 5	200359 21 7
11-1 9 11	71-1 7 46	192007 5 12	192088 15 8	200360 21 7
11-1 9 20	71-4 7 40	192008 5 14	192089 15 11	200361 7 54
11-1 11 5	83-1 13 6	192009 5 16	192090 15 14	200361 15 60
11-1 15 45	87-1 15 6	192010 5 19	192091 15 16	200361 17 39
14-1 11 3	89-1 15 12	192012 5 23	192092 15 18	200366 3 7
14-1 11 18	102-1 15 36	192013 11 1	192100 15 33	200370 19 2
14-1 19 11	102-2 15 37	192014 11 2	192102 15 35	200371 7 41
16-2 9 2	106-2 13 20	192015 11 15	192103 15 38	200372 7 42
16-2 9 6	107-1 17 2	192016 11 4	192104 15 40	200384 3 9
16-2 11 6	107-2 17 4	192017 11 8	192105 15 44	200385 9 23
16-2 15 9	109-1 15 29	192018 11 9	192107 A 17 1	200386 9 28
24-1 7 33	109-1 15 52	192019 11 12	192108 17 3	200387 7 1
24-1 7 35	109-1 17 6	192020 11 13	192109 17 5	200388 7 26
24-1 11 21	109-1 17 13	192021 11 14	192110 17 8	200389 7 21
24-1 13 4	120-2 17 29	192022 11 16	192111 17 10	200389 9 4
24-1 13 16	121 23 8	192023 11 17	192112 17 12	200389 9 9
24-1 13 23	123-1 7 55	192024 11 20	192114 17 15	200390 5 8
26-1 9 15	123-1 15 61	192025 11 22	192114-2 17 17	200390 7 20
26-1 9 29	123-1 17 34	192026 11 24	192115 17 19	200390 11 7
26-1 11 25	126 23 6	192027 11 23	192116 17 18	200440 21 15
28-1 9 22	127 23 1	192028 11 10	192117 17 23	200442 21 5
28-1 9 30	128 23 2	192029 9 8	192118 17 25	200443 13 15
28-1 9 38	128-2 3 11	192029 11 19	192119 17 26	200444 21 10
28-1 11 11	129-1 3 14	192032 9 1	192120 17 28	200445 21 10
28-1 15 13	130 A-9.5 23 9	192033 9 5	192121 17 31	200446 21 10
28-1 15 17	131 A 23 10	192035 9 10	192122 17 40	200449 21 7
30-1 11 26	132 23 7	192036 9 14	192123 7 51	200450 21 5
30-1 17 30	132-1 3 17	192037 9 16	192123 15 57	200451 21 14
31-1 7 48	143-1 7 45	192038 9 18	192123 17 33	200452 21 14
31-1 17 16	144-2 3 28	192040 9 19	192124 7 56	200475 21 8
31-1 17 24	206 23 5	192041 9 21	192124 15 62	200477 21 4
32-2 9 3	1092 15 49	192045 9 31	192124 17 35	200478 21 3
32-2 15 15	1231 9 45	192046 9 32	192125 17 36	200479 21 9
35-2 9 12	1333 15 25	192047 9 34	192126 7 57	200482 21 12
35-3 9 13	2022-3 5 6	192048 9 36	192126 15 63	200483 21 11
35-3 15 41	2022-3 5 24	192049 9 37	192126 17 37	200486 23 3
42-1 3 24	5306 7 7	192050 9 39	192127 A 17 38	200492 15 7
42-1 9 24	5307 7 2	192051 9 40	192127 A 7 52	200493 5 7
42-1 13 8	5308 7 3	192052 9 42	192127 A 15 58	200493 19 4
42-1 17 20	5309 15 4	192053 9 44	192128 3 10	200585 21 16
44-3 7 31	5310 3 22	192055 7 4	192129 A 3 12	200586 21 17
44-3 9 26	5311 3 3	192056 7 8	192130 3 15	200587 21 17
44-3 13 18	9070-2 7 38	192057 7 9	192131 3 13	200653 7 28
44-3 15 21	9207 23 11	192058 7 10	192132 3 16	200654 7 29
44-3 17 22	137010 3 4	192059 7 11	192133 3 19	200654 9 25
46-1 9 33	137011 G 3 5	192059-1 7 13	192137 3 21	201767 15 10
46-1 13 24	137011 G 3 8	192060 7 14	192138 3 23	202024 5 26
46-1 15 34	137108 15 48	192061 7 18	192138-3 3 26	202175 7 5
46-1 15 39	137109 15 50	192062 7 22	192144 A 3 27	202175 7 15
46-1 17 9	137142 3 25	192063 21 6	192145 A 3 29	202175 7 30
46-1 17 11	137142 15 53	192064 7 24	192150 7 49	202175 9 27
46-1 17 21	167061 15 30	192068 7 32	192152 7 53	202175 15 3
47-1 9 35	167061 15 42	192069 7 34	192153 A 7 50	202473 9 46
51-1 9 41	167061 17 7	192070 7 36	192154 9 17	202473 9 47
51-2 9 43	167063 17 14	192070-1 7 37	192148 15 59	D V x 1 23 12
55-1 7 6	191001 19 1	192071 21 1	193011 5 21	
59-1 7 12	191011 19 9	192071 A 21 2	193080 13 19	
59-1 7 19	191012 19 3	192071-3 7 39	193084 21 13	
60-1 7 16	191052 19 5	192072 13 1	193085 15 1	
60-2 7 17	191063 21 7	192072-1 13 2	193093 15 43	

PART NO.	PAGE	REF. NO.
208448	21	3
208448	21	13
208449	21	6
208449	21	16
210319	21	7
210319	21	17
306306	21	8
306306	21	18
306307	21	9
306307	21	19
306359	21	5
306359	21	15





■ PEGASUS  
SEWING MACHINE MFG.  
CO., LTD.®

