PFAFF[®] 545

Unterklassen-Ausstattung
Subclass parts
Composition des sous-classes
Composición de las subclases

Equipement des sous-classes¹⁾

Dotación de las subclases¹⁾

Unterklasse Subclass Sous-classe Subclase	Ausführung Model Version Tipo de máquina	Nadelstange Needle bar Barre à aiguille Barra de aguja	Stoffschieber Feed dog Griffe Transportador interior	Süßplatte Needle plate Plaque à aiguille Placa de aguja	Nußfuß Presser foot Pied presseur Pie prensaleñas
-2/01	H3 CN; DN	91-710 650-92	91-040 444-04 ⁽¹⁷⁷⁾	91-040 445-04 ⁽¹⁷⁷⁾	91-040 234-04 ⁽¹⁷⁷⁾
-6/01	H3 CN; DN	91-710 650-92	91-047 181-04	91-048 537-05	91-040 475-04 ⁽¹⁷⁷⁾
-6/01	H3 CN8; DN8 H4 CN8; DN8	91-710 650-92	91-026 745-04	91-048 922-04	91-049 585-04
-6/01	H3 CN10; DN10	91-710 650-92	91-047 241-04	91-048 639-04	91-049 573-04
-6/01	H4 CN; DN	91-710 650-92	91-042 944-04	91-042 945-04	91-046 731-04
-6/01	H4 CN10; DN 10	91-710 650-92	91-047 243-04	91-048 640-04	91-049 575-05
-6/01-900/11;/51	H3 CN	91-710 650-92	91-047 933-05	91-058 651-05	91-040 475-04 ⁽¹⁷⁷⁾
-6/01-900/16;/56	H3 CN	91-710 650-92	91-047 933-05	91-058 868-05	91-040 475-04 ⁽¹⁷⁷⁾
-6/01-900/11;/51	H3 CN8	91-710 650-92	91-047 933-05	91-058 651-05	91-049 585-04
-6/01-900/16;/56	H3 CN8	91-710 650-92	91-047 933-05	91-058 868-05	91-049 585-04
-6/01-900/11;/51	H3 CN10	91-710 650-92	91-047 998-05	91-058 684-05	91-049 573-04
-6/01-900/16;/56	H3 CN10	91-710 650-92	91-059 112-04	91-058 940-05	91-049 573-04
-17/01	H3 CN; DN	91-710 650-92	91-045 591-04	91-045 592-04	91-040 432-04 ⁽¹⁷⁷⁾
-17/41	H3 CN; DN	91-710 650-92	91-040 897-04	91-040 898-04	91-040 475-04 ⁽¹⁷⁷⁾
-17/43	H3 CN; DN	91-710 650-92	91-026 745-04	91-026 746-04	91-049 514-04 ⁽¹⁷⁷⁾
-17/43-900/11;/51	H3 CN	91-710 650-92	91-047 933-05	91-058 651-05	91-049 514-04 ⁽¹⁷⁷⁾
-17/43-900/16;/56	H3 CN	91-710 650-92	91-047 933-05	91-058 868-05	91-049 514-04 ⁽¹⁷⁷⁾
-19/01	H3 CN; DN	91-710 650-92	91-026 745-04	91-026 746-04	91-040 475-04 ⁽¹⁷⁷⁾
-19/01-900/11;/51	H3 CN	91-710 650-92	91-047 933-05	91-058 651-05	91-040 475-04 ⁽¹⁷⁷⁾
-19/01-900/16;/56	H3 CN	91-710 650-92	91-047 933-05	91-058 868-05	91-040 475-04 ⁽¹⁷⁷⁾
-19/02	H3 CN; DN	91-710 650-92	91-026 745-04	91-026 746-04	91-040 475-04 ⁽¹⁷⁷⁾
-19/02-900/11;/51	H3 CN	91-710 650-92	91-047 933-05	91-058 651-05	91-040 475-04 ⁽¹⁷⁷⁾
-19/02-900/16;/56	H3 CN	91-710 650-92	91-047 933-05	91-058 868-05	91-040 475-04 ⁽¹⁷⁷⁾
-39/01	H3 CN; DN	91-710 650-92	91-045 591-04	91-045 592-04	91-040 432-04 ⁽¹⁷⁷⁾
-39/21	H3 CN; DN	91-710 650-92	91-045 591-04	91-045 592-04	91-044 227-04 ⁽¹⁷⁷⁾
-39/41	H3 CN; DN	91-710 650-92	91-040 897-04	91-040 898-04	91-040 475-04 ⁽¹⁷⁷⁾
-39/81	H3 CN	91-710 650-92	91-047 399-04	91-048 924-04	91-040 432-04 ⁽¹⁷⁷⁾
-40/01	H3 CN; DN H4 CN; DN	91-710 650-92	91-026 745-04	91-026 746-04	91-044 102-04 ⁽¹⁷⁷⁾
-40/01	H3 CN8; DN8 H4 CN8; DN8	91-710 650-92	91-026 745-04	91-048 922-04	91-044 102-04 ⁽¹⁷⁷⁾
-40/01	H3 CN10; DN10	91-710 650-92	91-047 241-04	91-048 639-04	91-049 576-04 ⁽¹⁷⁷⁾
-40/01	H4 CN10; DN10	91-710 650-92	91-047 243-04	91-048 640-04	91-049 577-04 ⁽¹⁷⁷⁾
-40/01-900/11;/51	H3 CN; CN8	91-710 650-92	91-047 933-05	91-058 651-05	91-044 102-04 ⁽¹⁷⁷⁾
-40/01-900/16;/56	H3 CN; CN8	91-710 650-92	91-047 933-05	91-058 868-05	91-044 102-04 ⁽¹⁷⁷⁾
-40/01-900/11;/51	H3 CN10	91-710 650-92	91-047 998-05	91-058 684-05	91-049 576-04 ⁽¹⁷⁷⁾
-40/01-900/16;/56	H3 CN10	91-710 650-92	91-059 112-04	91-058 940-05	91-049 576-04 ⁽¹⁷⁷⁾
-40/05	H3 CN; DN H4 CN; DN	91-710 650-92	91-026 745-04	91-026 746-04	91-044 102-04 ⁽¹⁷⁷⁾
-40/05	H3 CN8; DN8 H4 CN8; DN8	91-710 650-92	91-026 745-04	91-048 922-04	91-044 102-04 ⁽¹⁷⁷⁾

Equipment des sous-classes¹⁾

Unterklassen-Ausstattung¹⁾

Dotacion de las subclases¹⁾

Subclass organization¹⁾

Unterklasse Subclasse Sous-classe Subclase	Stoffschleifer ¹⁾ Vibrating presser Pied entraîneur Transportador superior	Apparat ¹⁾ Attachement Appareil Aparato	Träger Bracket Support Soporte	Lineal Edge guide Guide-bord Guía recta	Halterwinkel Bracket Equerre de retenue Soporte angular	Bandteiler Tape disc Plateau dérouleur Plato portacintas	Fingerschutz Finger guard Protège-douglas Sarvadecus
-2/01	91-040 233-93 ¹²⁷²			91-040 998-25	91-025 559-25		91-055 203-9
-6/01	91-049 059-93						91-055 203-9
-6/01	91-040 474-93 ¹²⁷²						91-055 203-9
-6/01	91-040 474-93 ¹²⁷²						91-055 203-9
-6/01	91-046 732-93						91-055 203-9
-6/01	91-046 732-93						91-055 203-9
-6/01-900/11;/51	91-049 059-93						91-055 203-9
-6/01-900/16;/56	91-049 059-93						91-055 203-9
-6/01-900/11;/51	91-040 474-93 ¹²⁷²						91-055 203-9
-6/01-900/16;/56	91-040 474-93 ¹²⁷²						91-055 203-9
-6/01-900/11;/51	91-040 474-93 ¹²⁷²						91-055 203-9
-6/01-900/16;/56	91-040 474-93 ¹²⁷²						91-055 203-9
-17/01	91-042 819-93 ¹²⁷²	91-040 533-23	91-045 607-90			91-043 943-91	91-055 203-9
-17/41	91-040 474-93 ¹²⁷²	91-041 111-23	91-040 528-90			91-043 943-91	91-055 203-9
-17/43	91-049 021-93 ¹²⁷²	91-053 132-25	91-040 528-90				91-055 203-9
-17/43-900/11;/51	91-049 021-93 ¹²⁷²	91-053 132-25	91-040 528-90				91-055 203-9
-17/43-900/16;/56	91-049 021-93 ¹²⁷²	91-053 132-25	91-040 528-90				91-055 203-9
-19/01	91-040 474-93 ¹²⁷²	91-041 006-23	91-040 528-90				91-055 203-9
-19/01-900/11;/51	91-040 474-93 ¹²⁷²	91-041 006-23	91-040 528-90				91-055 203-9
-19/01-900/16;/56	91-040 474-93 ¹²⁷²	91-041 006-23	91-040 528-90				91-055 203-9
-19/02	91-040 474-93 ¹²⁷²	91-044 408-23	91-040 528-90				91-055 203-9
-19/02-900/11;/51	91-040 474-93 ¹²⁷²	91-044 408-23	91-040 528-90				91-055 203-9
-19/02-900/16;/56	91-040 474-93 ¹²⁷²	91-044 408-23	91-040 528-90				91-055 203-9
-39/01	91-042 819-93 ¹²⁷²	91-041 969-25	91-045 607-90			91-043 943-91	91-055 203-9
-39/21	91-042 819-93 ¹²⁷²	91-041 382-23	91-045 607-90			91-043 943-91	91-055 203-9
-39/41	91-040 474-93 ¹²⁷²	91-041 113-23	91-040 528-90			91-043 943-91	91-055 203-9
-39/81	91-042 819-93 ¹²⁷²	91-053 674-23	91-040 528-90			91-043 943-91	91-055 203-9
-40/01	91-044 101-93 ¹²⁷²	91-046 330-93	91-042 940-90 ○				91-055 203-9
-40/01	91-044 101-93 ¹²⁷²	91-046 330-93	91-042 940-90 ○				91-055 203-9
-40/01	91-049 070-93 ¹²⁷²	91-046 330-93	91-042 940-90 ○				91-055 203-9
-40/01	91-049 071-93 ¹²⁷²	91-046 330-93	91-042 940-90 ○				91-055 203-9
-40/01-900/11;/51	91-044 101-93 ¹²⁷²	91-046 330-93	91-042 940-90 ⊗				91-055 203-9
-40/01-900/16;/56	91-044 101-93 ¹²⁷²	91-046 330-93	91-042 940-90 ⊗				91-055 203-9
-40/01-900/11;/51	91-049 070-93 ¹²⁷²	91-046 330-93	91-042 940-90 ⊗				91-055 203-9
-40/01-900/16;/56	91-049 070-93 ¹²⁷²	91-046 330-93	91-042 940-90 ⊗				91-055 203-9
-40/05	91-044 101-93 ¹²⁷²	91-053 256-93	91-042 940-90 ○				91-055 203-9
-40/05	91-044 101-93 ¹²⁷²	91-053 256-93	91-042 940-90 ○				91-055 203-9

Erläuterungen siehe nächste Seite
 See next page for explanations
 Explications, voir page suivante
 Para las explicaciones véase la
 página siguiente

Equipement des sous-classes¹⁾

Dotación de las subclases¹⁾

Unterklasse Subclass Sous-classe Subclase	Ausführung Model Version Tipo de máquina	Nadelnlanze Needle bar Barre à aiguille Barra de aguja	Stoffschieber ^[1] Feed dog Griffe Transportador inferior	Silchplatte ^[1] Needle plate Plaque à aiguille Placa de aguja	Nähfuß ^[1] Presser foot Pied presseur Pie prensatejas	Stoffschiebetul ^[1] Vibrating presser Pied enfilaieur Transportador superior
-40/05	H3 CN10; DN10	91-710 650-92	91-047 241-04	91-048 639-04	91-049 576-04 [5]	91-049 070-93 [5]
-40/05	H4 CN10; DN10	91-710 650-92	91-047 243-04	91-048 640-04	91-049 577-04 [5]	91-049 071-93 [5]
-40/05-900/11;/51	H3 CN; CN8	91-710 650-92	91-047 933-05	91-058 651-05	91-044 102-04 [5]	91-044 101-93 [5]
-40/05-900/16;/56	H3 CN; CN8	91-710 650-92	91-047 933-05	91-058 868-05	91-044 102-04 [5]	91-044 101-93 [5]
-40/05-900/11;/51	H3 CN10	91-710 650-92	91-047 998-05	91-058 684-05	91-049 576-04 [5]	91-049 070-93 [5]
-40/05-900/16;/56	H3 CN10	91-710 650-92	91-059 112-04	91-058 940-05	91-049 576-04 [5]	91-049 070-93 [5]
-40/09	H3 CN; DN	91-710 650-92	91-026 745-04	91-026 746-04	91-044 102-04 [5]	91-044 101-93 [5]
-40/09-900/11;/51	H3 CN	91-710 650-92	91-047 933-05	91-058 651-05	91-044 102-04 [5]	91-044 101-93 [5]
-40/09-900/16;/56	H3 CN	91-710 650-92	91-047 933-05	91-058 868-05	91-044 102-04 [5]	91-044 101-93 [5]
-95/02	H3 CN; DN	91-710 650-92	91-026 745-04	91-026 746-04	91-040 475-04 [172]	91-040 474-93 [172]
-95/02-900/11;/51	H3 CN	91-710 650-92	91-047 933-05	91-058 651-05	91-040 475-04 [172]	91-040 474-93 [172]
-95/02-900/16;/56	H3 CN	91-710 650-92	91-047 933-05	91-058 868-05	91-040 475-04 [172]	91-040 474-93 [172]
-122/01	H3 CN	91-710 650-92	91-047 400-04	91-048 925-04	91-049 588-04 [5]	91-049 087-93 [5]
-136/02	H3 CN; DN	91-710 650-92	91-026 745-04	91-026 746-04	91-049 514-04 [5]	91-049 021-93 [5]
-136/02-900/11;/51	H3 CN	91-710 650-92	91-047 933-05	91-058 651-05	91-049 514-04 [5]	91-049 021-93 [5]
-136/02-900/16;/56	H3 CN	91-710 650-92	91-047 933-05	91-058 868-05	91-049 514-04 [5]	91-049 021-93 [5]
-155/01	H3 CN	91-710 650-92	91-045 591-04	91-045 592-04	91-040 432-04 [172]	91-042 819-93 [172]
-155/41	H3 CN; DN	91-710 650-92	91-040 897-04	91-040 898-04	91-040 475-04 [172]	91-040 474-93 [172]
-167/02	H3 CN	91-710 650-92	91-026 745-04	91-026 746-04	91-040 475-04 [172]	91-040 474-93 [172]
-167/02-900/11;/51	H3 CN	91-710 650-92	91-047 933-05	91-058 651-05	91-040 475-04 [172]	91-040 474-93 [172]
-167/02-900/16;/56	H3 CN	91-710 650-92	91-047 933-05	91-058 868-05	91-040 475-04 [172]	91-040 474-93 [172]
-168/02	H3 CN; DN	91-710 650-92	91-026 745-04	91-026 746-04	91-042 180-04 [5]	91-042 181-93 [5]
-168/02-900/11;/51	H3 CN	91-710 650-92	91-047 933-05	91-058 651-05	91-042 180-04 [5]	91-042 181-93 [5]
-168/02-900/16;/56	H3 CN	91-710 650-92	91-047 933-05	91-058 868-05	91-042 180-04 [5]	91-042 181-93 [5]
-195/02	H3 CN	91-710 650-92	91-026 745-04	91-026 746-04	91-040 475-04 [172]	91-040 474-93 [172]
-195/02-900/11;/51	H3 CN	91-710 650-92	91-047 933-05	91-058 651-05	91-040 475-04 [172]	91-040 474-93 [172]
-195/02-900/16;/56	H3 CN	91-710 650-92	91-047 933-05	91-058 868-05	91-040 475-04 [172]	91-040 474-93 [172]
-195/04	H3 CN	91-710 650-92	91-045 591-04	91-045 592-04	91-044 227-04 [172]	91-042 819-93 [172]
-226/02	H3 CN	91-710 650-92	91-026 745-04	91-026 746-04	91-046 719-04 [5]	91-046 720-93 [5]
-226/02-900/11;/51	H3 CN	91-710 650-92	91-047 933-05	91-058 651-05	91-046 719-04 [5]	91-046 720-93 [5]
-226/02-900/16;/56	H3 CN	91-710 650-92	91-047 933-05	91-058 868-05	91-046 719-04 [5]	91-046 720-93 [5]
-248/02	H3 CN	91-710 650-92	91-026 745-04	91-026 746-04	91-046 656-04	91-046 657-93
-248/02-900/11;/51	H3 CN	91-710 650-92	91-047 933-05	91-058 651-05	91-046 656-04	91-046 657-93
-248/02-900/16;/56	H3 CN	91-710 650-92	91-047 933-05	91-058 868-05	91-046 656-04	91-046 657-93
-308/01	H3 CN	91-710 650-92	91-047 271-04 [5]	91-048 682-04 [5]	91-049 592-05	91-049 077-93 [5]
-308/05	H3 CN	91-710 650-92	91-047 271-04 [5]	91-048 682-04 [5]	91-049 592-05	91-049 077-93 [5]
-735/01-6/01	H3 BN	91-715 436-92	91-047 250-04	91-048 653-03	91-049 582-05	91-049 074-93
-735/01-40/01	H4 CN	91-715 436-92	91-494 441-04	91-494 442-04	91-492 222-04	91-492 221-93 [5]

¹⁾ Die Liste enthält nur die reinen Unterklassenteile und nicht die Teile, die für den Umbau in eine andere Ausführungsart erforderlich sind, wie z. B. von Ausführung „CN“ in „CN 10“ usw. Geben Sie daher bei der Bestellung von Umbauteilen die vollständige Bezeichnung der vorhandenen und der gewünschten Maschine an.

¹⁾ This list contains only pure subclass parts and not parts which are necessary for converting a machine to another model, as, for example, from model "CN" to "CN 10" etc. For this reason please always state the full number of the existing version and the new version required when ordering conversion parts.

¹⁾ Cette liste ne mentionne que les pièces de la sous-classe et non celles nécessaires pour transformer la machine en une autre version, par ex. de la version „CN“ en „CN 10“, etc. En cas de commande de pièces de transformation, veuillez donc préciser la désignation complète du modèle existant et celle du nouveau modèle désiré.

¹⁾ Esta lista sólo contiene las piezas propias de la subclase y no las necesarias para la transformar en otro tipo de máquina, del tipo „CN“ al „CN 10“ por ejemplo. Por tanto, siempre que se haç un pedido de piezas para transformar una máquina, deberá indicarse la denominación completa del tipo de máquina que se tiene y del tipo deseado.

91-710 650-92

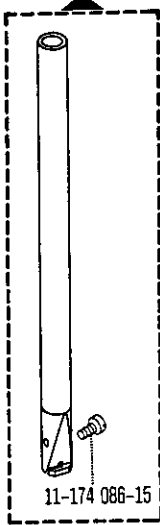

11-174 086-15

- 2/01
- 6/01
- 6/01-900/..
- 17/01
- 17/41
- 17/43
- 17/43-900/..
- 19/01
- 19/01-900/..
- 19/02
- 19/02-900/..
- 39/01
- 39/21
- 39/41
- 39/81
- 40/01
- 40/01-900/..
- 40/05
- 40/05-900/..
- 40/09
- 40/09-900/..
- 95/02
- 95/02-900/..
- 122/01
- 136/02
- 136/02-900/..
- 155/01
- 155/41
- 167/02
- 167/02-900/..
- 168/02
- 168/02-900/..
- 195/02
- 195/02-900/..
- 195/04
- 226/02
- 226/02-900/..
- 248/02
- 248/02-900/..
- 308/01
- 308/05
- 735/01-40/01

91-715 436-92

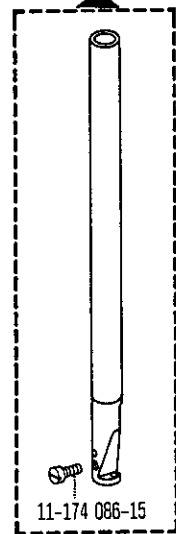

11-174 086-15

-735/01-6/01

91-026 745-04



- 6/01 H3 CN8; DN8
- 6/01 H4 CN8; DN8
- 17/43 H3 CN; DN
- 19/01 H3 CN; DN
- 19/02 H3 CN; DN
- 40/01 H3 CN; DN
- 40/01 H3 CN8; DN8
- 40/01 H4 CN; DN
- 40/01 H4 CN8; DN8
- 40/05 H3 CN; DN
- 40/05 H3 CN8; DN8
- 40/05 H4 CN; DN
- 40/05 H4 CN8; DN8
- 40/05 H3 CN; DN
- 40/05 H3 CN8; DN8
- 40/05 H4 CN; DN
- 40/05 H4 CN8; DN8
- 40/09 H3 CN; DN
- 95/02 H3 CN; DN
- 136/02 H3 CN; DN
- 167/02 H3 CN
- 168/02 H3 CN; DN
- 195/02 H3 CN
- 226/02 H3 CN
- 248/02 H3 CN

91-040 444-04



-2/01

91-040 897-04

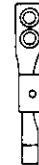

- 17/41 H3 CN; DN
- 39/41 H3 CN; DN
- 155/41 H3 CN; DN

91-042 944-04

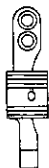

-6/01 H4 CN; DN

91-045 591-04

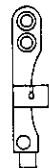

- 17/01 H3 CN; DN
- 39/01 H3 CN; DN
- 39/21 H3 CN; DN
- 155/01 H3 CN; DN
- 195/04 H3 CN; DN

91-047 181-04



-6/01 H3 CN; DN

91-047 241-04



- 6/01 H3 CN10; DN10
- 40/01 H3 CN10; DN10
- 40/05 H3 CN10; DN10

91-047 243-04



- 6/01 H4 CN10; DN10
- 40/01 H4 CN10; DN10
- 40/05 H4 CN10; DN10

91-047 250-04



-735/01-6/01 H3 BN

91-047 271-04

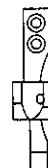





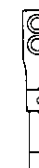





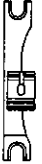

- 308/01 H3 CN
- 308/05 H3 CN



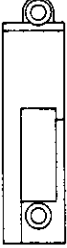









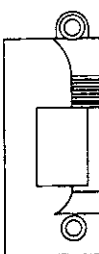





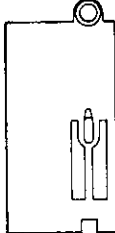







91-047 399-04









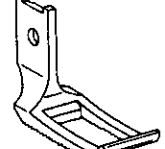







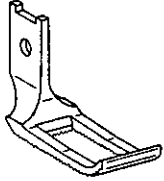





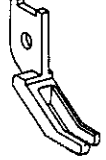





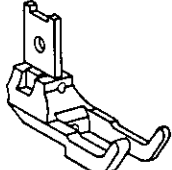





-39/81 H3 CN

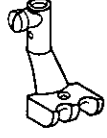





















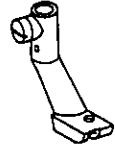







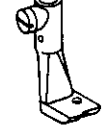

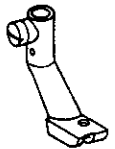

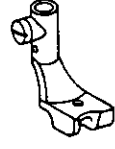
Unterklassen-Ubersicht/ Table of subclasses/ Table des sous-classes/ Tabla de subclases

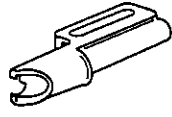
<p>91-047 400-04 </p> <p>-122/01 H3 CN</p>	<p>91-047 933-05</p> <p>-6/01-900/.. H3 CN; CN8 -17/43-900/.. H3 CN -19/01-900/.. H3 CN -19/02-900/.. H3 CN -40/01-900/.. H3 CN; CN8 -40/05-900/.. H3 CN; CN8 -40/09-900/.. H3 CN</p> <p>-95/02-900/.. H3 CN -136/02-900/.. H3 CN -167/02-900/.. H3 CN -168/02-900/.. H3 CN -195/02-900/.. H3 CN -226/02-900/.. H3 CN -248/02-900/.. H3 CN</p>	<p>91-047 998-05</p>  <p>-6/01-900/11; /51 H3 CN10 -40/01-900/11; /51 H3 CN10 -40/05-900/11; /51 H3 CN10</p>	
<p>91-059 112-04 </p> <p>-6/01-900/16; /56 H3 CN10 -40/01-900/16; /56 H3 CN10 -40/05-900/16; /56 H3 CN10</p>	<p>91-494 441-04 </p> <p>-735/01-40/01 H4 CN</p>		
<p>91-026 746-04 </p>	<p>-40/09 H3 CN; DN -17/43 H3 CN; DN -19/01 H3 CN; DN -19/02 H3 CN; DN -40/01 H3 CN; DN -40/01 H4 CN; DN -40/05 H3 CN; DN -40/05 H4 CN; DN</p> <p>-95/02 H3 CN; DN -136/02 H3 CN; DN -167/02 H3 CN -168/02 H3 CN; DN -195/02 H3 CN -226/02 H3 CN -248/02 H3 CN</p>	<p>91-040 445-04 </p> <p>-2/01 H3 CN; DN</p>	<p>91-040 898-04 </p> <p>-17/41 H3 CN; DN -39/41 H3 CN; DN -155/41 H3 CN; DN</p>
<p>91-042 945-04 </p> <p>-6/01 H4 CN; DN</p>	<p>91-045 592-04 </p> <p>-17/01 H3 CN; DN -39/01 H3 CN; DN -39/21 H3 CN; DN -155/01 H3 CN -195/04 H3 CN</p>	<p>91-048 537-05</p>  <p>-6/01 H3 CN; DN</p>	<p>91-048 639-04 </p> <p>-6/01 H3 CN10; DN10 -40/01 H3 CN10; DN10 -40/05 H3 CN10; DN10</p>
<p>91-048 640-04 </p> <p>-6/01 H4 CN10; DN10 -40/01 H4 CN10; DN10 -40/05 H4 CN10; DN10</p>	<p>91-048 653-03 </p> <p>-735/01-6/01 H3 BN</p>	<p>91-048 682-04 </p> <p>-308/01 H3 CN -308/05 H3 CN</p>	<p>91-048 922-04 </p> <p>-6/01 H3 CN8; DN8 -6/01 H4 CN8; DN8 -40/01 H3 CN8; DN8 -40/01 H4 CN8; DN8 -40/05 H3 CN8; DN8 -40/05 H4 CN8; DN8</p>

<p>91-048 924-04 </p>  <p>-39/81 H3 CN</p>	<p>91-048 925-04 </p>  <p>-122/01 H3 CN</p>	<p>91-058 651-05</p>  <p>-6/01-900/11; /51 H3 CN -6/01-900/11; /51 H3 CN8 -17/43-900/11; /51 H3 CN -19/01-900/11; /51 H3 CN -19/02-900/11; /51 H3 CN -40/01-900/11; /51 H3 CN; CN8 -40/05-900/11; /51 H3 CN; CN8</p> <p>-40/09-900/11; /51 H3 CN -95/02-900/11; /51 H3 CN -136/02-900/11; /51 H3 CN -167/02-900/11; /51 H3 CN -168/02-900/11; /51 H3 CN -195/02-900/11; /51 H3 CN -226/02-900/11; /51 H3 CN -248/02-900/11; /51 H3 CN</p>	
<p>91-058 684-05</p>  <p>-6/01-900/11; /51 H3 CN10 -40/01-900/11; /51 H3 CN10 -40/05-900/11; /51 H3 CN10</p>	<p>91-058 868-05</p>  <p>-6/01-900/16; /56 H3 CN -6/01-900/16; /56 H3 CN8 -17/43-900/16; /56 H3 CN -19/01-900/16; /56 H3 CN -19/02-900/16; /56 H3 CN -40/01-900/16; /56 H3 CN8 -40/05-900/16; /56 H3 CN8</p>	<p>91-058 940-05</p>  <p>-40/09-900/16; /56 H3 CN -95/02-900/16; /56 H3 CN -136/02-900/16; /56 H3 CN -167/02-900/16; /56 H3 CN -168/02-900/16; /56 H3 CN -195/02-900/16; /56 H3 CN -226/02-900/16; /56 H3 CN -248/02-900/16; /56 H3 CN</p> <p>-6/01-900/16; /56 H3 CN10 -40/01-900/16; /56 H3 CN10 -40/05-900/16; /56 H3 CN10</p>	
<p>91-494 442-04 </p>  <p>-735/01-40/01 H4 CN</p>	<p>91-040 234-04 </p>  <p>-2/01</p>	<p>91-040 432-04 </p>  <p>-17/01 -39/01 -39/81 -155/01</p>	<p>91-040 475-04 </p>  <p>-19/01 -19/01-900/.. -19/02 -19/02-900/.. -39/41 -95/02 -95/02-900/.. -155/41 -167/02 -6/01 -167/02-900/.. -6/01-900/.. -195/02 -17/41 -195/02-900/..</p>
<p>91-042 180-04 </p>  <p>-168/02 -168/02-900/..</p>	<p>91-044 102-04 </p> 	<p>-40/01 H3 CN; DN -40/01 H4 CN; DN -40/01 H3 CN8; DN8 -40/01 H4 CN8; DN8 -40/01-900/.. H3 CN; CN8 -40/05 H3 CN; DN -40/05 H4 CN; DN -40/05 H3 CN8; DN8 -40/05 H4 CN8; DN8 -40/05-900/.. H3 CN; CN8 -40/09 H3 CN; DN -40/09-900/.. H3 CN</p>	
<p>91-044 227-04 </p>  <p>-39/21 -195/04</p>	<p>91-046 656-04 </p>  <p>-248/02 -248/02-900/..</p>	<p>91-046 719-04 </p>  <p>-226/02 -226/02-900/..</p>	<p>91-046 731-04 </p>  <p>-6/01 H4 CN; DN</p>

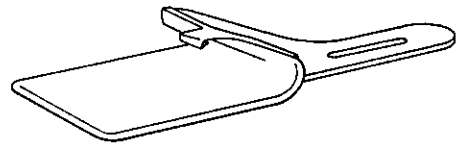
Unterklassen-Ubersicht/ Table of subclasses/ I abie des sous-classes/ I abia de subciases

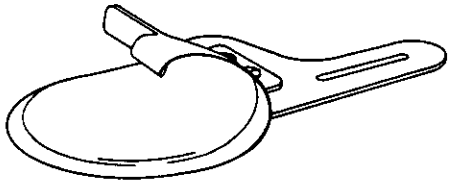
<p>91-049 514-04  </p>  <p>-17/43 -17/43-900/.. -136/02 -136/02-900/..</p>	<p>91-049 573-04 </p>  <p>-6/01 H3 CN10; DN10 -6/01-900/.. H3 CN10</p>	<p>91-049 575-05</p>  <p>-6/01 H4 CN10; DN10</p>	<p>91-049 576-04  </p>  <p>-40/01 H3 CN10; DN10 -40/01-900/.. H3 CN10 -40/05 H3 CN10; DN10 -40/05-900/.. H3 CN10</p>
<p>91-049 577-04  </p>  <p>-40/01 H4 CN10; DN10 -40/05 H4 CN10; DN10</p>	<p>91-049 582-05</p>  <p>-735/01-6/01</p>	<p>91-049 585-04 </p>  <p>-6/01 H3 CN8; DN8 -6/01 H4 CN8; DN8 -6/01-900/.. H3 CN8</p>	<p>91-049 588-04 </p>  <p>-122/01</p>
<p>91-049 592-05</p>  <p>-308/01 -308/05</p>	<p>91-492 222-04 </p>  <p>-735/01-40/01</p>		
<p>91-040 233-93  </p>  <p>-2/01</p>	<p>91-040 474-93  </p>  <p>-6/01 H3 CN8; DN8 -6/01 H4 CN8; DN8 -6/01 H3 CN10; DN10 -6/01-900/.. H3 CN8 -6/01-900/.. H3 CN10 -17/41 H3 CN; DN -19/01 H3 CN; DN -19/01-900/.. H3 CN -19/02 H3 CN; DN -19/02-900/.. H3 CN -19/02-900/.. H3 CN</p>		<p>91-042 181-93  </p>  <p>-168/02 -168/02-900/..</p>
<p>91-042 819-93  </p>  <p>-17/01 H3 CN; DN -39/01 H3 CN; DN -39/21 H3 CN; DN -39/81 H3 CN -155/01 H3 CN -195/04 H3 CN</p>	<p>91-044 101-93  </p>  <p>-40/01 H3 CN; DN -40/01 H4 CN; DN -40/01 H3 CN8; DN8 -40/01 H4 CN8; DN8 -40/01-900/.. H3 CN; CN8 -40/05 H3 CN; DN -40/05 H4 CN; DN -40/05 H3 CN8; DN8 -40/05 H4 CN8; DN8 -40/05-900/.. H3 CN; CN8 -40/09 H3 CN; DN -40/09-900/.. H3 CN</p>		<p>91-046 657-93 </p>  <p>-248/02 -248/02-900/..</p>

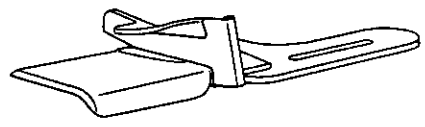
<p>91-046 720-93  </p>  <p>-226/02 H3 CN -226/02-900/.. H3 CN</p>	<p>91-046 732-93 </p>  <p>-6/01 H4 CN; DN -6/01 H4 CN10; DN10</p>	<p>91-049 021-93  </p>  <p>-17/43 H3 CN; DN -17/43-900/.. H3 CN -136/02 H3 CN; DN -136/02-900/.. H3 CN</p>	<p>91-049 059-93 </p>  <p>-6/01 CN; DN -6/01-900/.. H3 CN</p>
<p>91-049 070-93  </p>  <p>-40/01 H3 CN10; DN10 -40/01-900/.. H3 CN10 -40/05 H3 CN10; DN10 -40/05-900/.. H3 CN10</p>	<p>91-049 071-93  </p>  <p>-40/01 H4 CN10; DN10 -40/05 H4 CN10; DN10</p>	<p>91-049 074-93 </p>  <p>-735/01-6/01 H3 BN</p>	<p>91-049 077-93  </p>  <p>-308/01 H3 CN -308/05 H3 CN</p>
<p>91-049 087-93  </p>  <p>-122/01 H3 CN</p>	<p>91-492 221-93  </p>  <p>-735/01-40/01 H4 CN</p>		
<p><u>91-040 533-23</u> </p>  <p>-17/01</p>	<p>91-040 600-23 </p>  <p>-155/01</p>	<p>91-040 798-23 </p>  <p>-195/02 -195/02-900/..</p>	
<p><u>91-041 006-23</u> </p>  <p>-19/01 -19/01-900/..</p>		<p>91-041 111-23 </p>  <p>-17/41</p>	

Unterklassen-Übersicht/Table of subclasses/Table des sous-classes/Tabla de subclasses

91-041 112-23 [5]

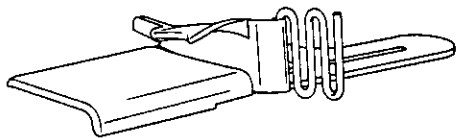

-155/41

91-041 113-23 [5]

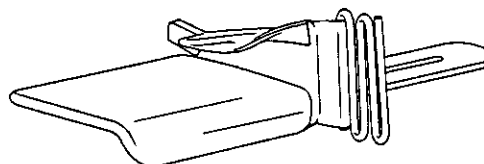

-39/41

91-041 382-23 [5]

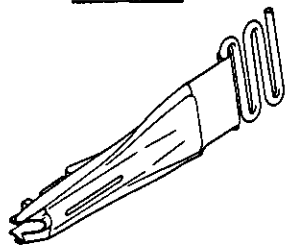

-39/21

91-041 969-25 [5]

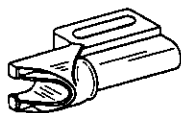

-39/01

91-041 991-25 [5]



-195/04

91-042 099-23 [5]

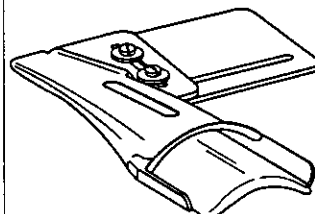

-167/02
-167/02-900/..

91-042 179-23 [5]

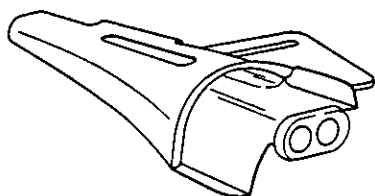

-168/02
-168/02-900/..

91-043 941-23 [5]



-95/02
-95/02-900/..

91-044 408-23 [5]

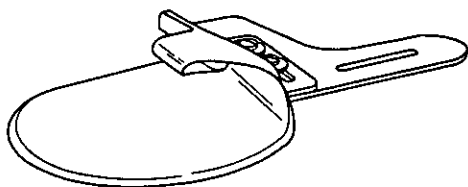

-19/02
-19/02-900/..

91-046 330-93 [5]

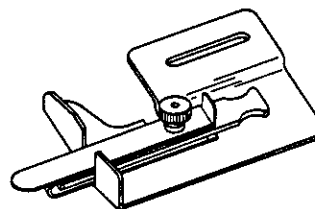

-40/01
-40/01-900/..

91-046 653-21 [5]



-248/02
-248/02-900/..

91-046 721-25 [5]

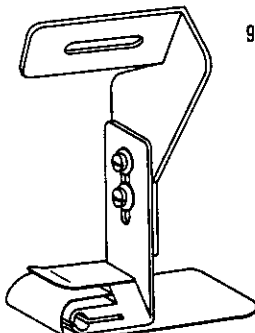

-226/02
-226/02-900/..

91-053 078-23 [5]

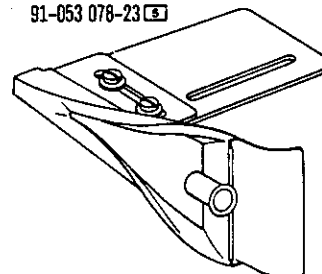

-136/02
-136/02-900/..

91-053 132-25 [E]

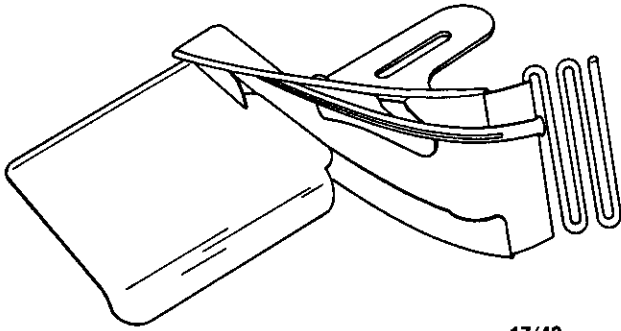

-17/43
-17/43-900/..

91-053 255-93 [E]

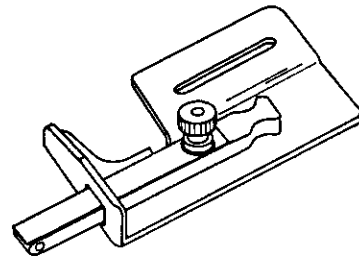

-40/09
-40/09-900/..

91-053 256-93 [E]

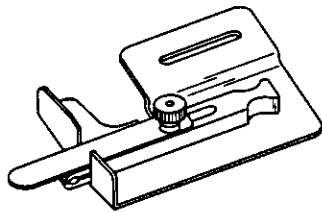

-40/05
-40/05-900/..

91-053 674-23 [E]

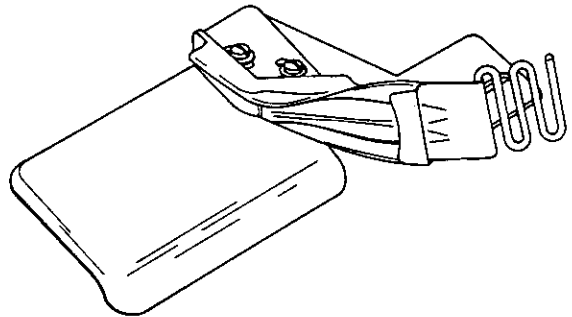

-39/81

91-053 699-93 [E]

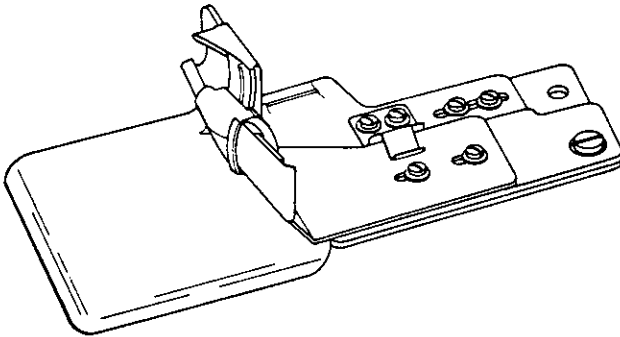

-308/01

91-053 700-93 [E]

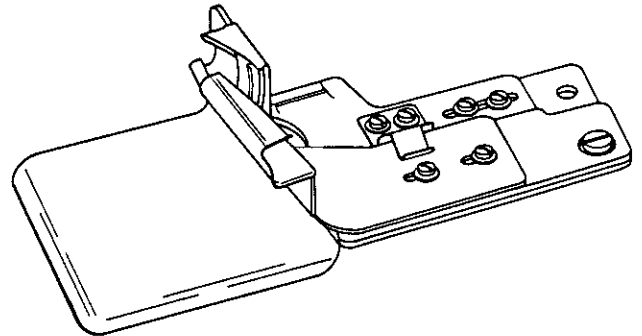

-308/05

91-491 939-23 [E]

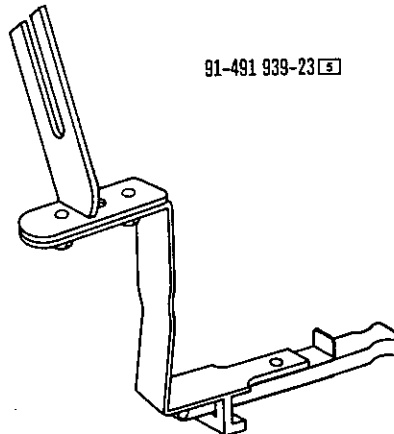

-735/01-40/01

91-010 702-91

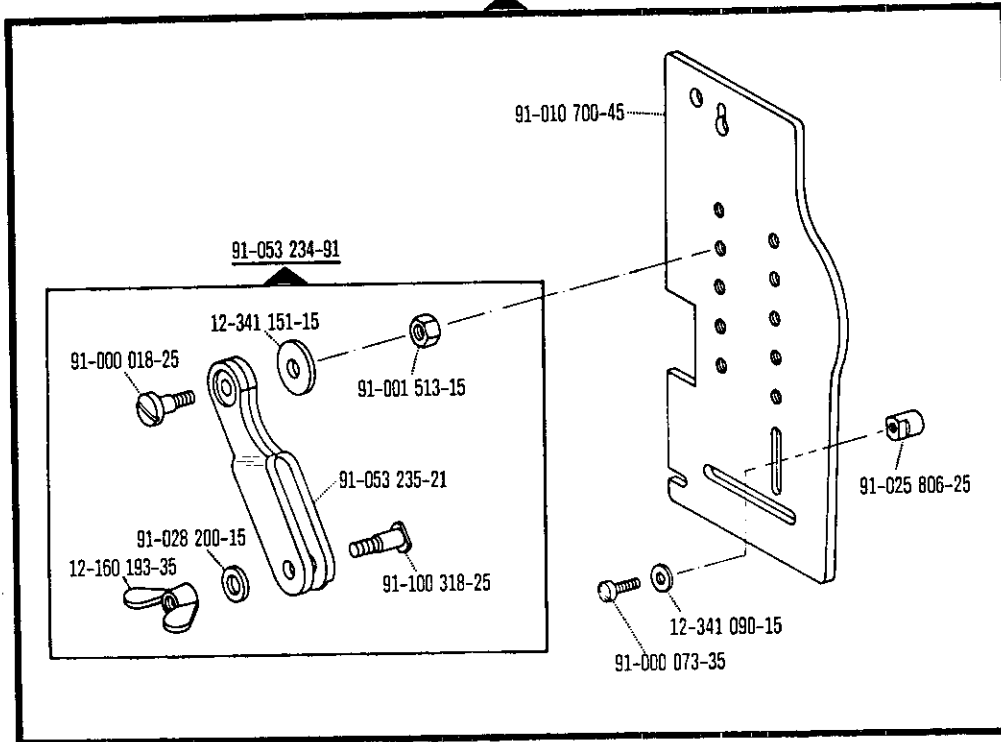

-226/02
-226/02-900/..
-735/01-40/01

91-040 528-90

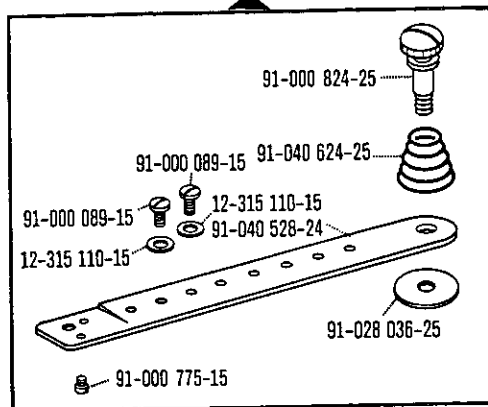

-17/41
-17/43
-17/43-900/..
-19/01
-19/01-900/..
-19/02
-19/02-900/..
-39/41
-39/81
-95/02
-95/02-900/..
-136/02
-136/02-900/..
-155/41
-167/02
-167/02-900/..
-168/02
-168/02-900/..
-195/02
-195/02-900/..

91-040 862-90

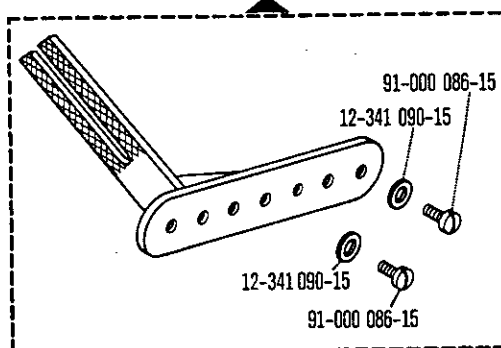

-226/02
-226/02-900/..
-735/01-40/01

91-042 940-90

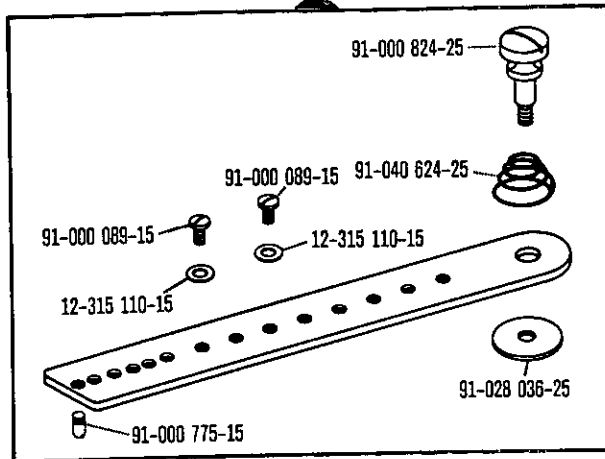

- 40/01
- 40/01-900/..
- 40/05
- 40/05-900/..
- 40/09
- 40/09-900/..
- 248/02
- 248/02-900/..

91-045 607-90

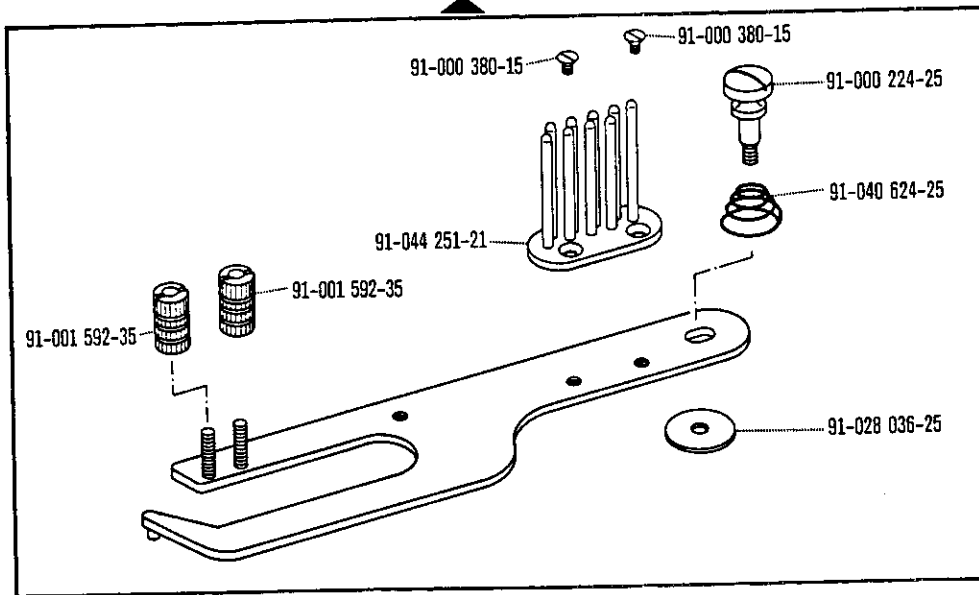

- 17/01
- 39/01
- 39/21
- 155/01
- 195/04

91-018 424-25

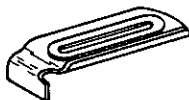

-735/01-40/01

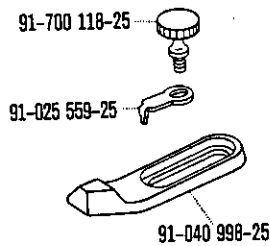

-2/01

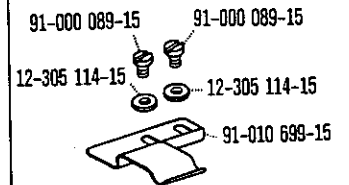

- 308/01
- 308/05

Unterklassen-Übersicht/Table of subclasses/Table des sous-classes/Tabla de subclasses

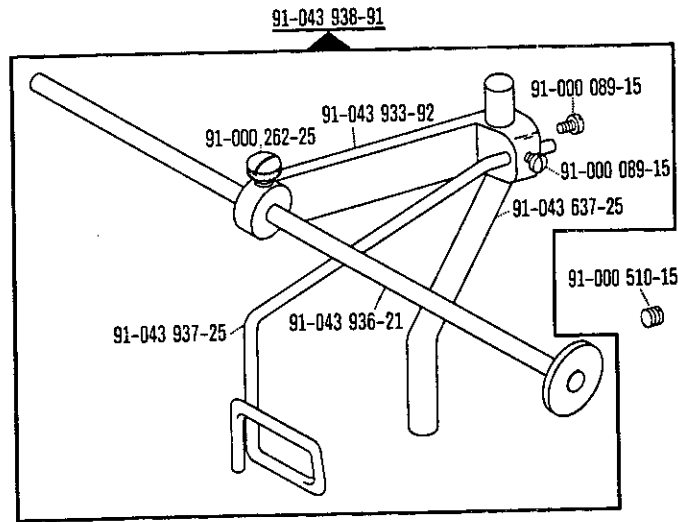

-226/02
-226/02-900/..

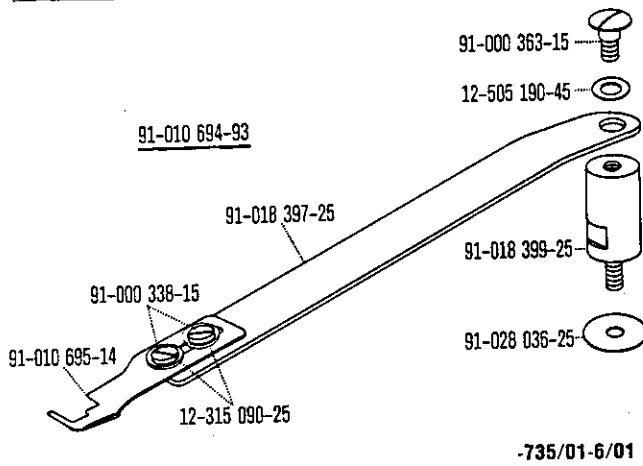

91-492 330-14



-735/01-40/01

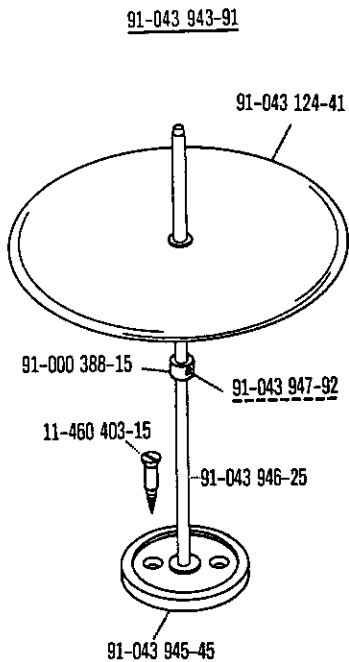

91-010 625-24

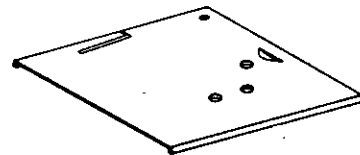

-40/01
-40/05
-40/09
-248/02

91-492 006-25

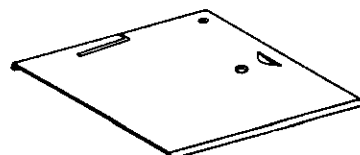

-40/01-900/..
-40/05-900/..
-40/09-900/..
-248/02-900/..

91-055 203-91

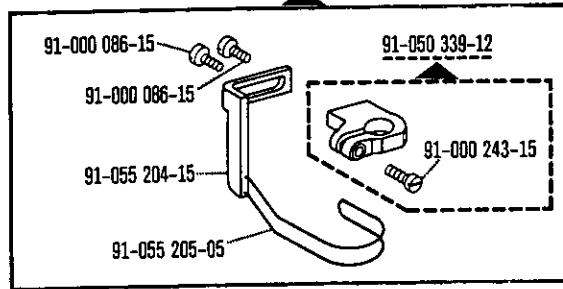

-2/01	-95/02
-6/01	-95/02-900/..
-6/01-900/..	-122/01
-17/01	-136/02
-17/41	-136/02-900/..
-17/43	-155/01
-17/43-900/..	-155/41
-19/01	-167/02
-19/01-900/..	-167/02-900/..
-19/02	-168/02
-19/02-900/..	-168/02-900/..
-39/01	-195/02
-39/01	-195/02-900/..
-39/21	-195/04
-39/41	-226/02
-39/81	-226/02-900/..
-40/01	-248/02
-40/01-900/..	-248/02-900/..
-40/05	-308/01
-40/05-900/..	-308/05
-40/09	-735/01-6/01
-40/09-900/..	-735/01-40/01

Pfaff, D 6750 Kaiserslautern, Postfach 3020/3040, Telex: 45 753