



3334-958/01

Automatic Lockstitch Bartacker

for making tacks

measuring up to

7/8" x 1 7/16"

Instruction Book

and

Service Manual

PFAFF INDUSTRIEMASCHINEN GMBH KAISERSLAUTERN

Contents

| | Page |
|---|--------------|
| A. Instructions for Operators | 4—19 |
| 1. Brief Description of Machine | 4 |
| 2. Setting Up the Machine | 4 |
| 3. Cleaning and Oiling | 6 |
| 4. Winding the Bobbin | 9 |
| 5. Threading the Bobbin Case | 10 |
| 6. Selecting the Correct Needle | 11 |
| 7. Threading the Needle | 12 |
| 8. Regulating the Thread Tensions | 13 |
| 9. Starting the Machine | 14 |
| 10. Stopping the Machine | 15 |
| 11. Trimming the Threads | 15 |
| 12. Feeding the Material | 16 |
| 13. Regulating the Feed Across Motion | 17 |
| 14. Regulating the Feed Lengthwise Motion | 18 |
| 15. Dismantling the Shuttle Race | 19 |
| B. Instructions for Mechanics | 20—35 |
| 16. Centering the Needle in the Needle Hole | 20 |
| 17. Timing the Shuttle | 20 |
| 18. Adjusting the Crosswise Clamp Travel | 20 |
| 19. Adjusting the Lengthwise Clamp Travel | 22 |
| 20. Timing the Feed Cam | 23 |
| 21. Timing the Knife Cam | 24 |
| 22. Adjusting the Knife Bar | 25 |
| 23. Changing the Knives | 26 |
| 24. Adjusting the Knife Motion | 27 |
| 25. Adjusting the Stop Motion Lever | 28 |
| 26. Adjusting the Brake Lever | 29 |
| 27. Adjusting the Tripping Lever | 30 |
| 28. Adjusting the Stop Tripping Segments | 30 |
| 29. Timing the Thread Nipper | 30 |
| 30. Changing the Buffer Spring | 31 |
| 31. Adjusting the Cone Clutch | 34 |
| 32. Trouble Shooting | 35 |

Foreword

This instruction book contains much valuable information about the Pfaff 3334 automatic lockstitch bartacker. Though not intended as a full-scale textbook capable of answering all questions related to sewing exhaustively, it offers sufficient information on the construction, function and operation of the various mechanisms to enable every interested operator to get to know her machine and attain maximum efficiency as quickly as possible.

The instructions for mechanics contained in the second part of this book will no doubt be much appreciated by all maintenance men servicing our sewing machines since even the best sewing machine will work satisfactorily only if it is employed properly and serviced by an expert. We have made every effort to render the presentation of these instructions as simple as possible and have included numerous illustrations in order to afford a better understanding.

We welcome any suggestions and recommendations which you may wish to make.

Illustrations in which round-belt drives are to be seen also apply to a limited extent to machines having V-belt drive (-958/01).

**Pfaff Industriemaschinen GmbH
Kaiserslautern**

A. Instructions for Operators

1. Brief Description of Machine

The Pfaff 3334 and 3334-958/01 are equipped with central bobbin shuttle and link take-up and designed for tacking bars of every description automatically. Their range of applications embraces all branches of the sewing industry.

The number of stitches per tack varies according to the purpose of employment of the different subclass machines.

The work is held between the workclamp and the feed plate and moved under the needle as required by the tack design. The needle bar moves up and down only and does not swing sideways.

The length and crosswise feed motion needed to produce the tack is derived from two cams which are carried on a joint shaft on either side of the machine arm. The right cam has two control slots milled into its front and back sides. While the channel track on the front controls the feed across motion, the slot on the back controls the motion of the work lengthwise of the machine arm. Another function of this cam is to stop the machine at the end of the sewing cycle.

When you depress the right treadle, the stop motion mechanism is disengaged, the tripping lever engaged and the driving belt shifted from the loose to the driving pulley.

While the machine is in operation, the lifting lever is locked so that the work clamp cannot be raised.

The left cam operates the needle and bobbin thread knives and moves them from the inoperative to the operative position.

When you depress the left treadle after the machine has been stopped automatically, the work clamp is raised and both threads trimmed simultaneously.

2. Setting Up the Machine

Sewing head and power table are packed separately. To make the machine ready for use, place the sewing head on the table so that the mounting holes are in line and the machine can be secured in position with the bolts supplied. Then mount the driving belt and attach the belt guard, screwing its bracket to the back of the tabletop.

The long chain serves to raise the clamp feet. Its top end is hooked into hook **A** of lifting lever **B** (Fig. 6), the chain pulled through the cutout in the tabletop, and its lower end connected to the left pedal.

The short chain is hooked into the hole at the front end of starting lever **C** (Fig. 3) which is accessible after tilting the machine back. The other end of the chain is connected to the right pedal.

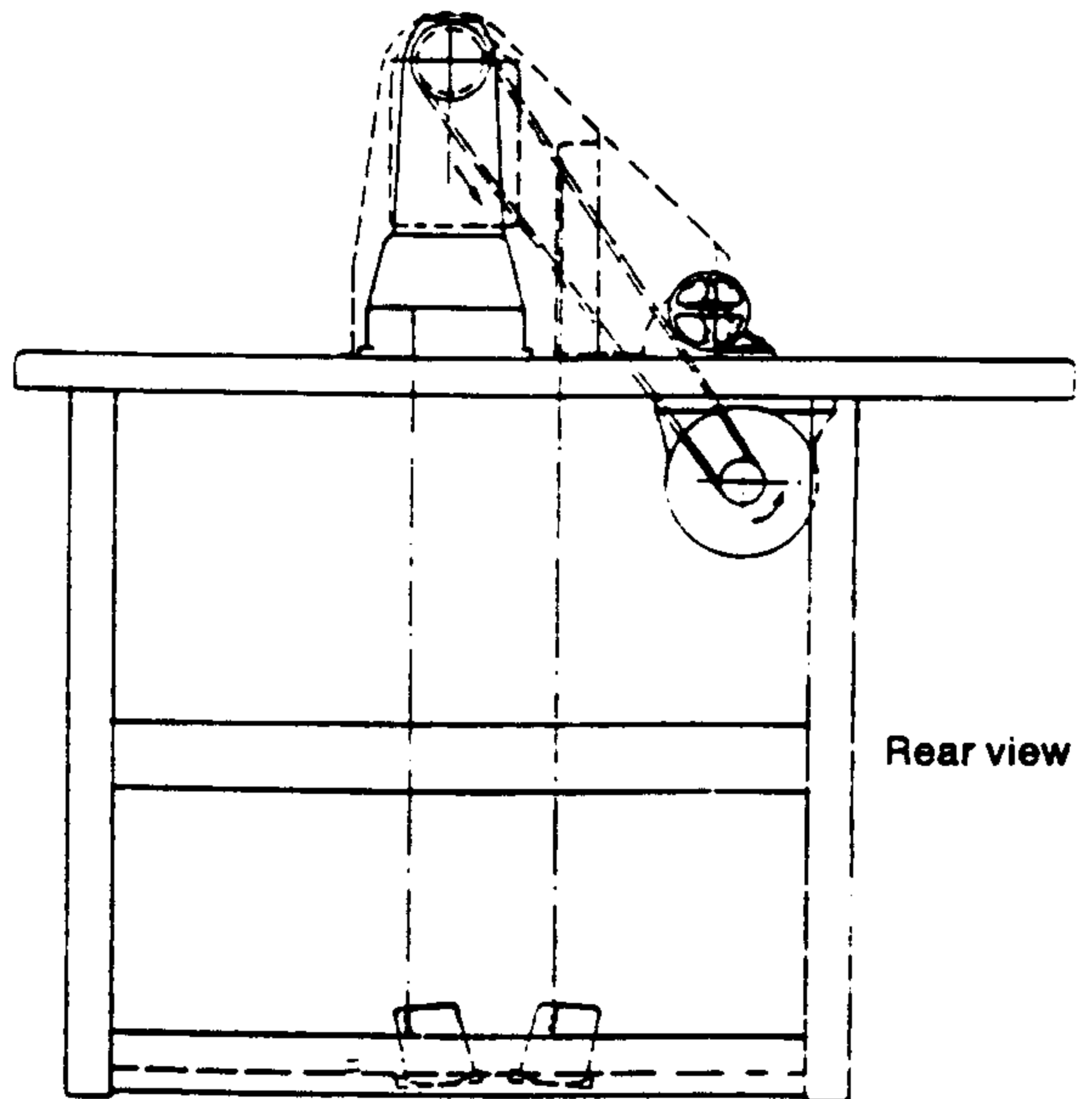

Fig. 1

On the Pfaff 3334-958/01, power is transmitted by a slip-proof V-belt. The idler and drive pulleys together form a maintenance free cone clutch, whose lining is located on the drive pulley.

When the motor is started, the V-belt pulley of the machine idles, i. e. the clutch is disengaged.

When starting the machine by operating its starting lever, the forked clutch lever presses the conical idler pulley against the drive pulley lining, thus turning the drive pulley. The machine now runs at a constant speed.

The clutch remains engaged until the machine stops automatically. When it stops, the idler pulley is automatically separated from the drive pulley, i. e. the clutch is disengaged and the V-belt pulley idles. (Fig. 2)

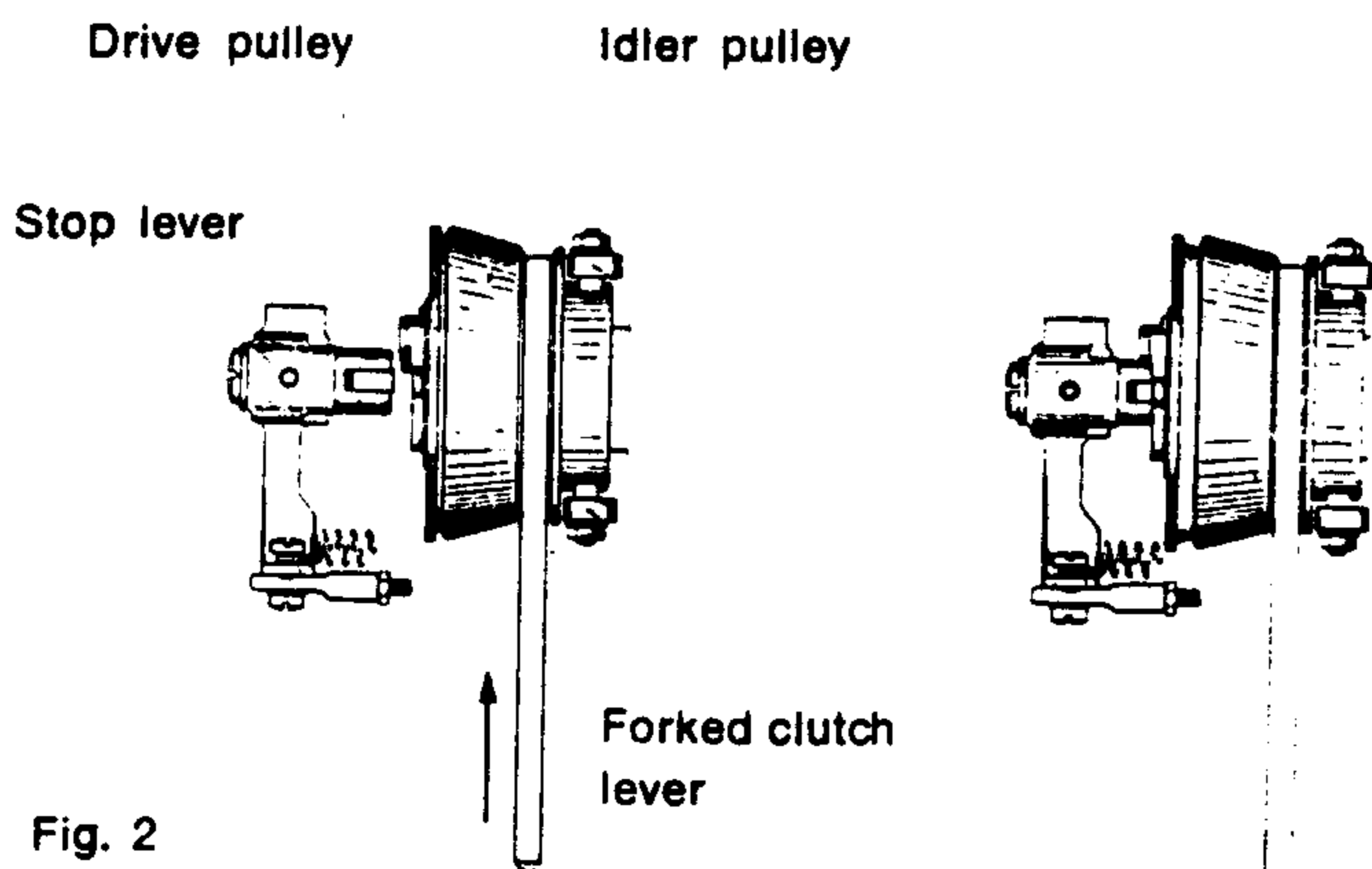

Fig. 2

3. Cleaning and Oiling

Careful cleaning and regular oiling increase the service life of the machine and ensure smooth running.

When the machine is delivered, all polished parts are covered with a rust-preventative lubricant. Remove this grease, together with the dust which has accumulated in transit, before you put the machine in operation. Also, squirt an ample amount of oil into all marked oiling points, unthread the needle, take out the bobbin case, and run the machine to work the oil into all the bearings.

All important oiling points are marked by arrows in Figs. 3-6 and, wherever feasible, with red paint on the machine.

To reach the oiling points in the cylinder arm and the machine base, remove the belt guard, loosen wing nut D (Fig. 3), swing away catch E, tilt the machine over to the left, and rest it on the wooden peg.

When the machine is in operation constantly, form the habit of removing, several times a day, the lint which has accumulated in the vicinity of the shuttle and putting a drop of oil into the shuttle race. Run the machine with a scrap of material under the work clamp to absorb excess oil.

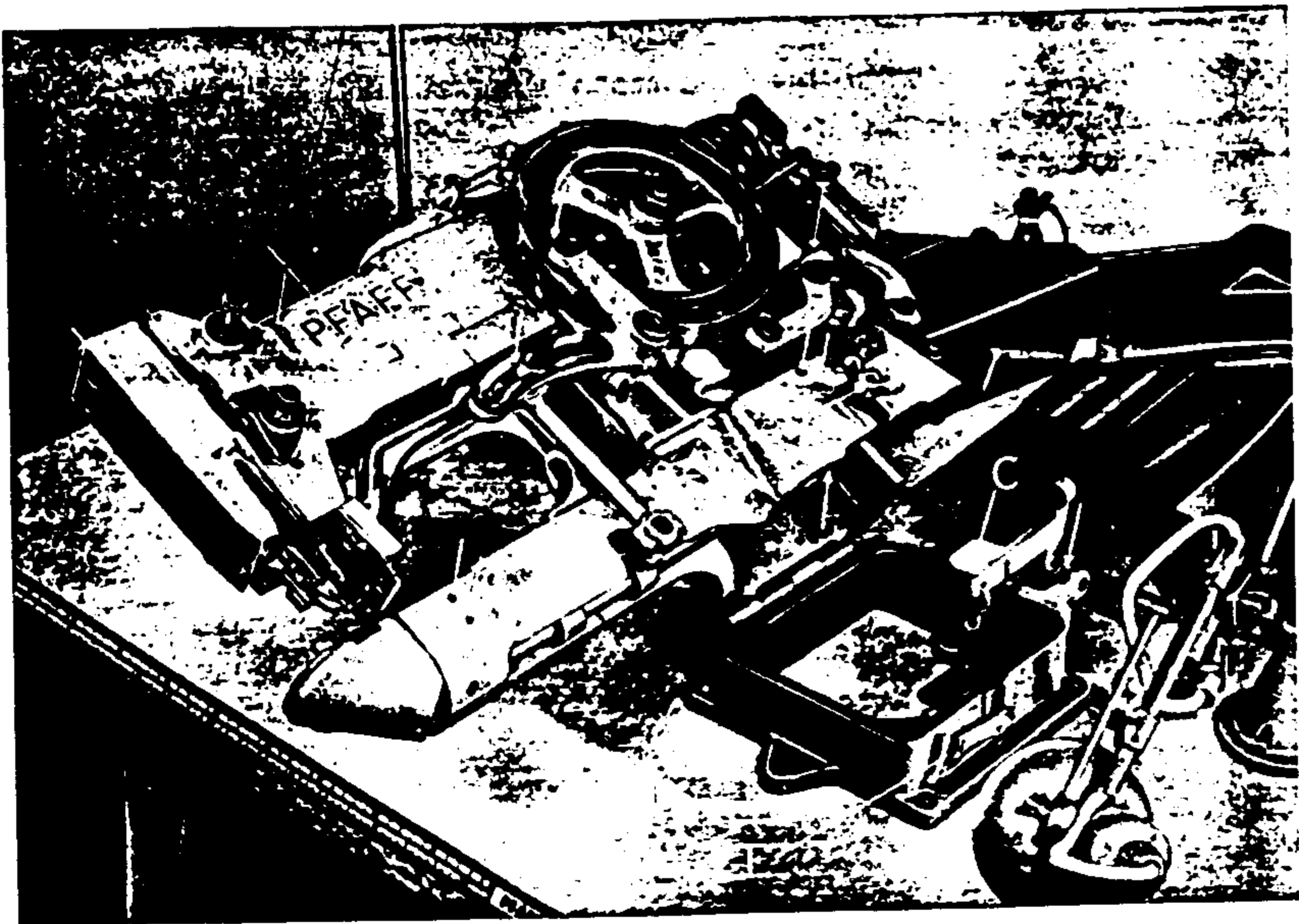

R 5787

Fig. 3

R 5783

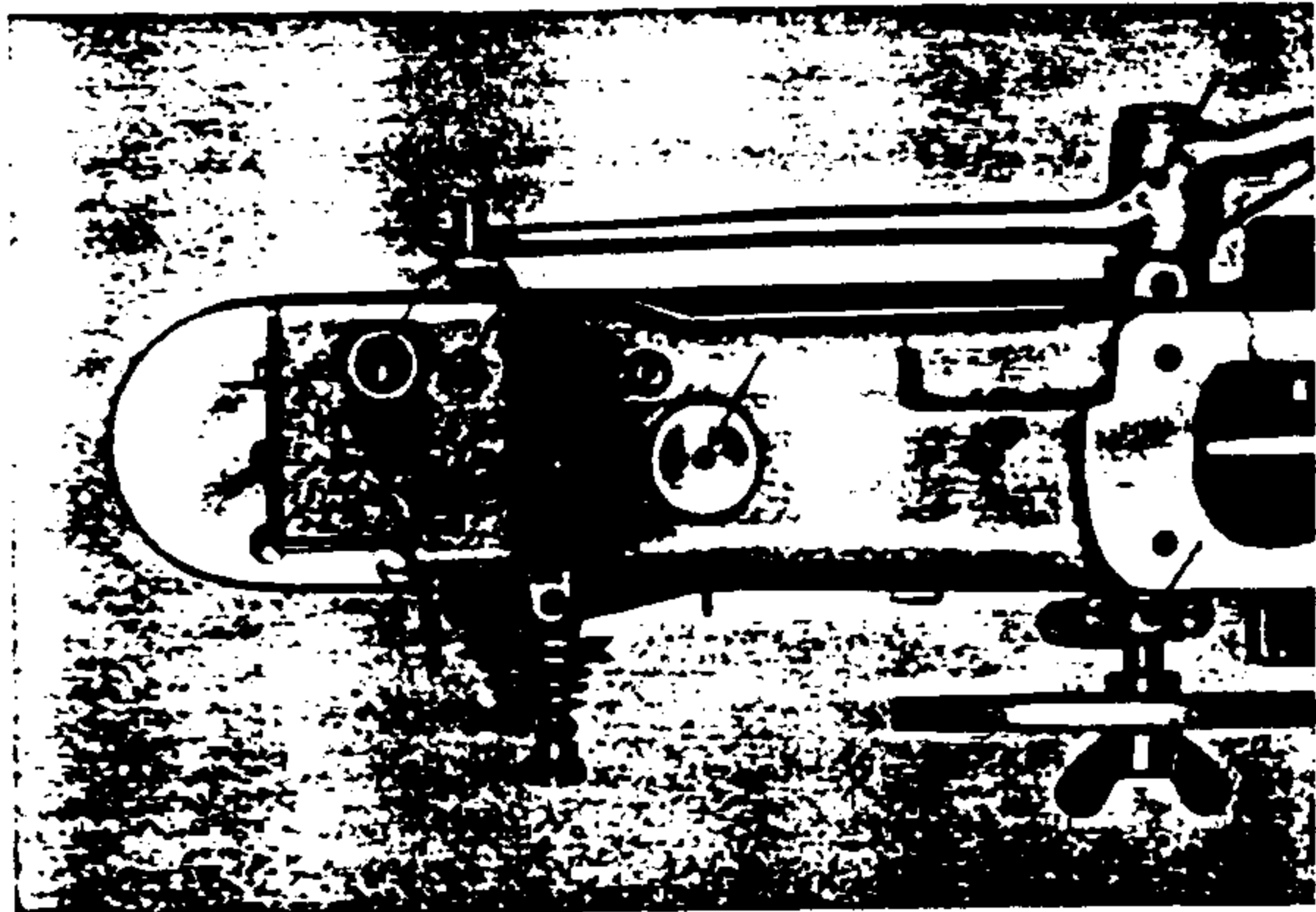

Fig. 4

R 5796

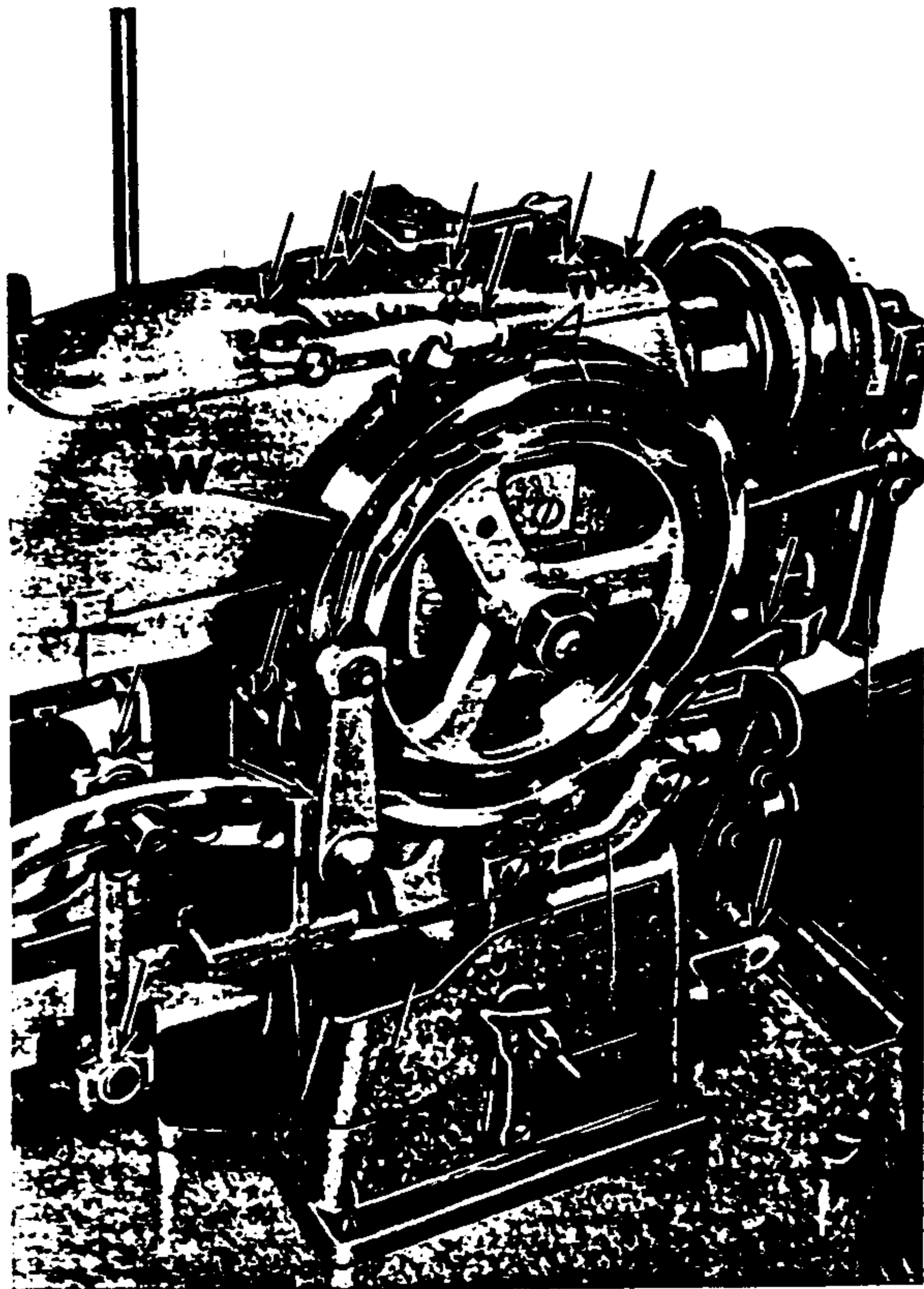

Fig. 5

Certain sewing troubles, such as skipping of stitches or thread breaking, cannot be remedied by lavish oiling. Excessive quantities of oil are liable to soil the work or mix with the dirt and lint in the machine and cause hard running.

Therefore, oil sparingly but regularly!

Since Pfaff sewing machine oil No. 280-1-120122 has the correct lubricating properties and is non-resinous, use no other oil.

R 7579

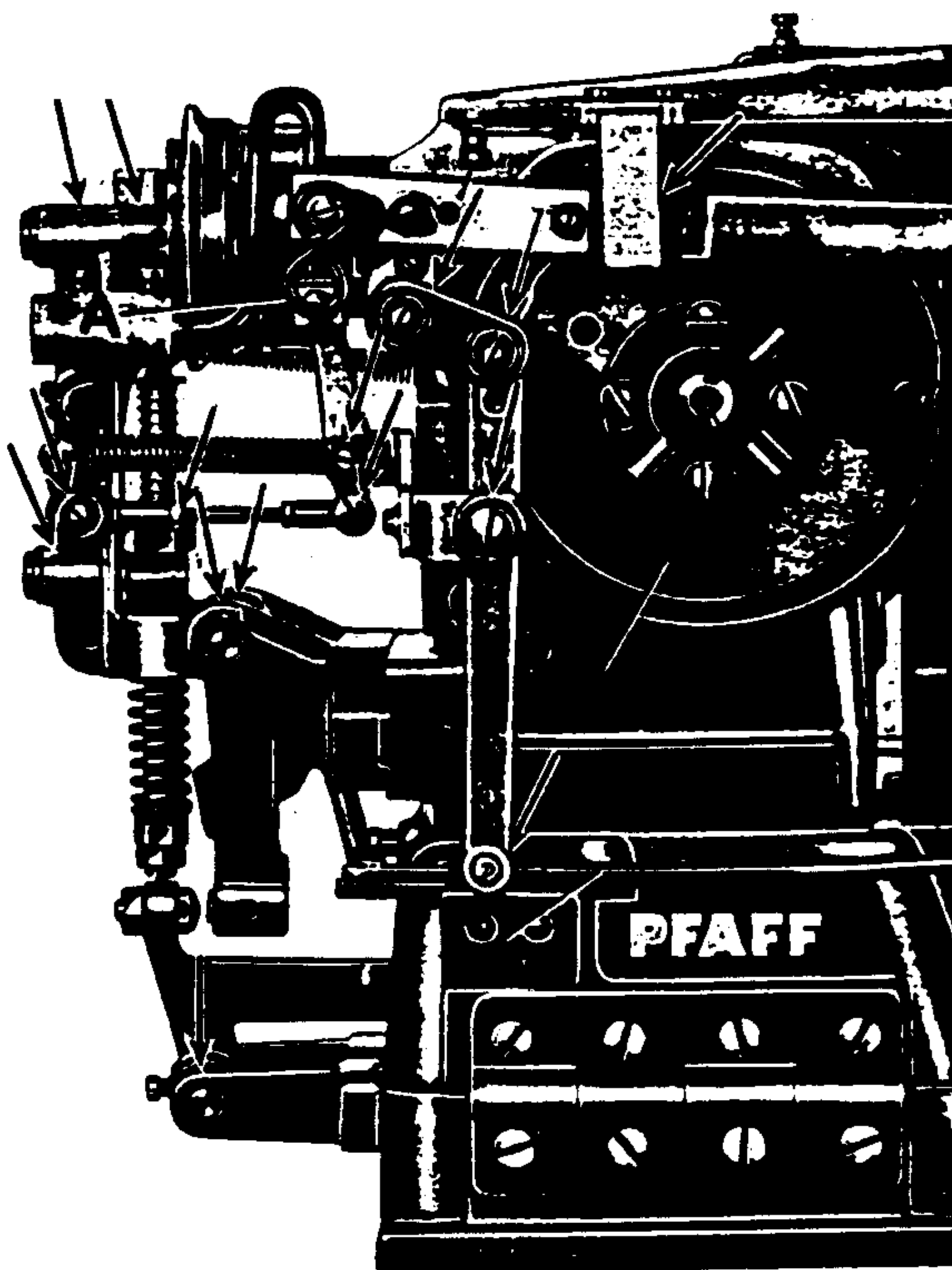

Fig. 6

4. Winding the Bobbin

Place the bobbin winder on the table so that its pulley will not contact the machine belt when the winder is disengaged, and screw it down (Fig. 7). The bobbin winder tension is located on the belt guard and can be adjusted sideways to bring bobbin and tension in line. To do this, loosen the two screws.

Place a spool of thread on spool pin 1 and an empty bobbin on the bobbin winder spindle. Pass the thread from the spool through thread guide 2, from back to front around and between tension discs 3, and down to bobbin 4. Pull the thread through the slot in the bobbin, from the inside, and press in lever 5. Hold the end of the thread and start the machine. Having wound a few turns, break off the end and continue winding.

The amount of thread to be wound on the bobbin is regulated by screw 6, as follows:

Turn screw right for more thread,
or left for less thread.

R 9502

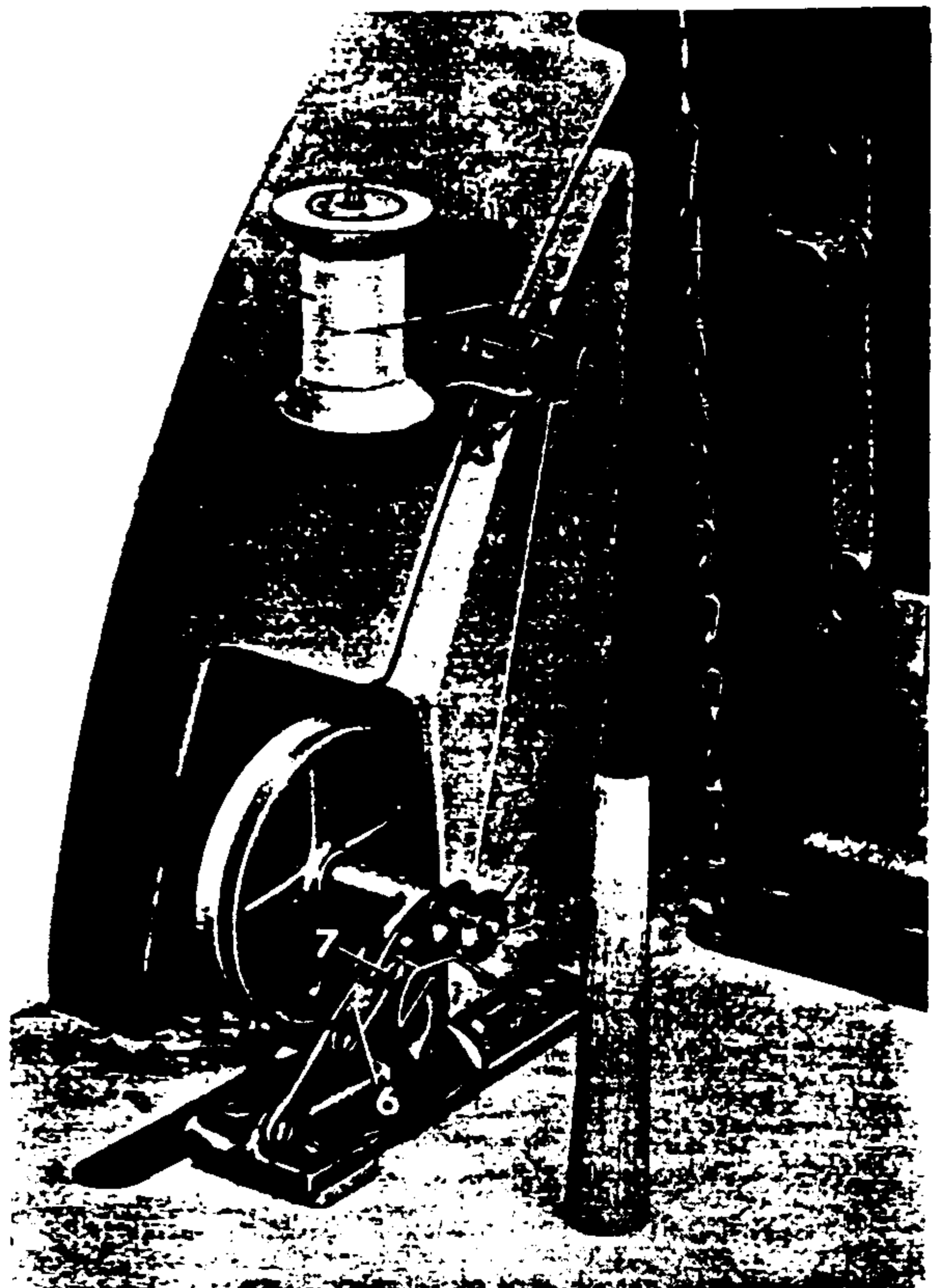

Fig. 7

5. Threading the Bobbin Case

To remove the empty bobbin, open the cap on the cylinder arm, lift the bobbin case latch and pull out bobbin case and bobbin. When you release the latch, the empty bobbin drops out.

Next, insert the full bobbin into the bobbin case, as shown in Fig. 8, and hold it firmly in the case. Pull the thread into slot 1 (Fig. 9) and draw it under the tension spring into delivery eye 2 (Fig. 10) and through hole 3 in the position finger (Fig. 10). Leave about three inches of thread hanging from the bobbin case.

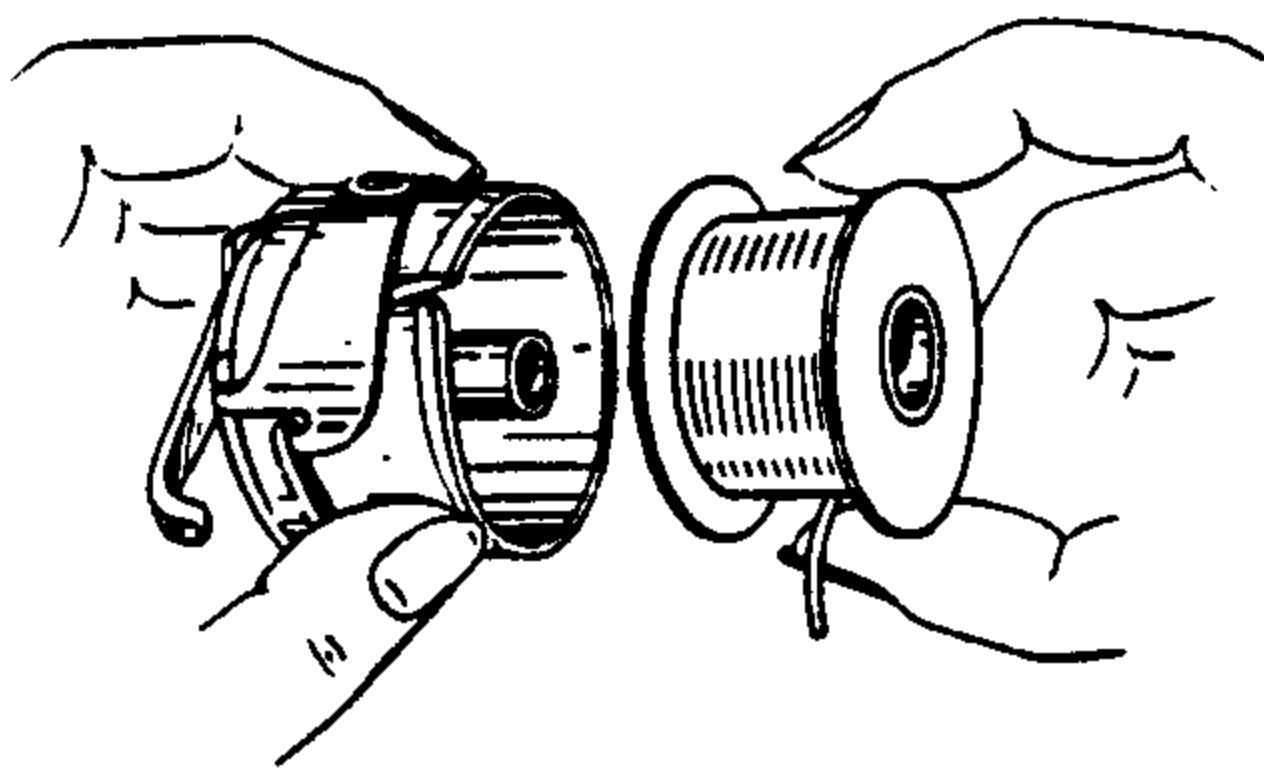

Fig. 8

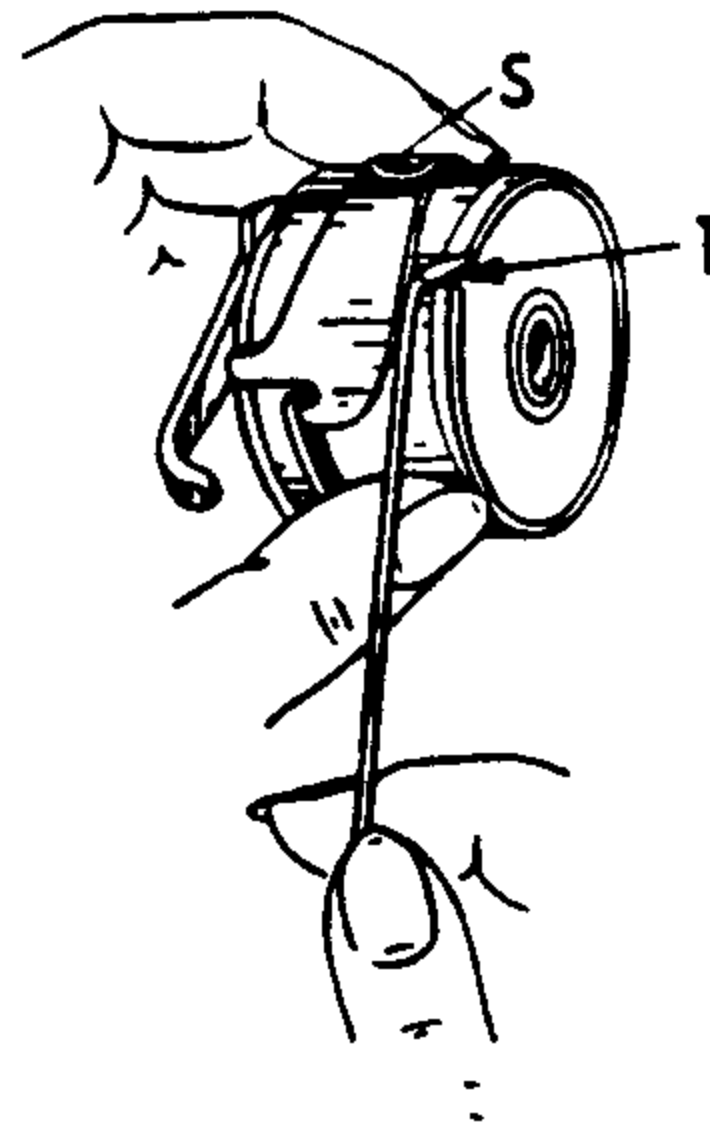

Fig. 9

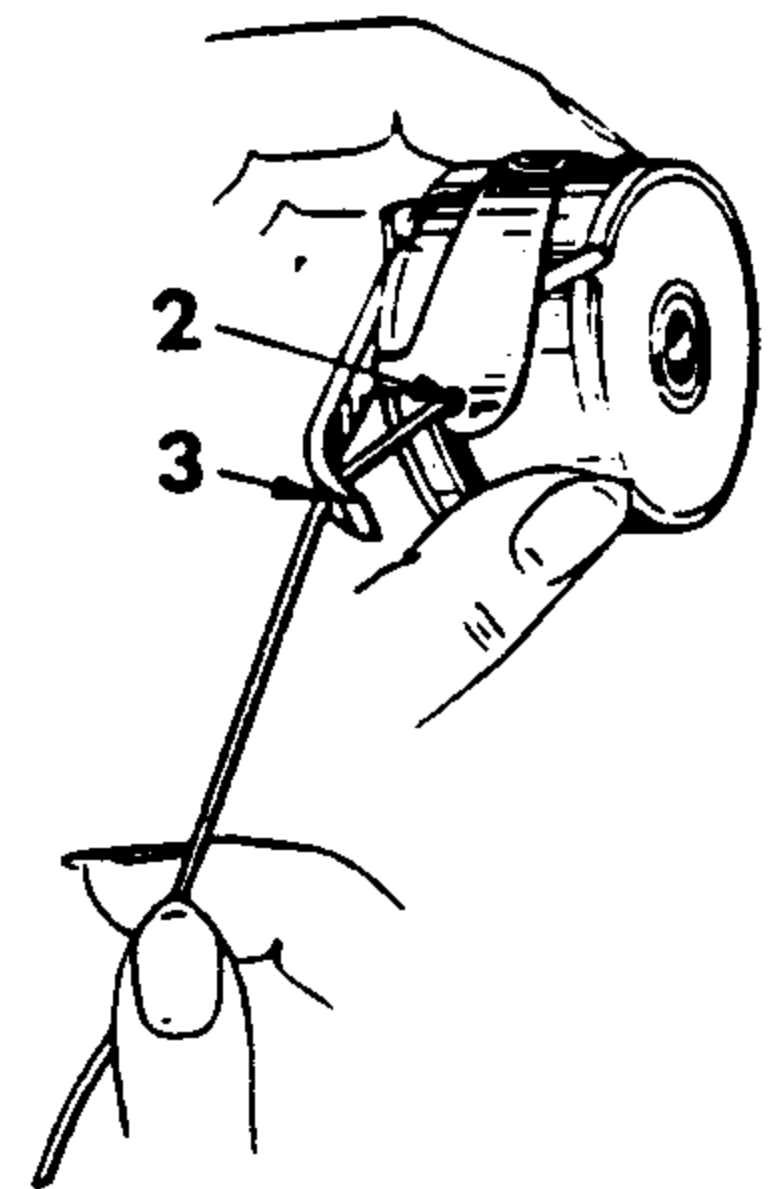

Fig. 10

When inserting the bobbin case, make sure that the position finger enters the slot in the shuttle race ring and that the loose end of thread does not get jammed between position finger and edge of slot. Press against the bobbin case until you hear it snap into place.

6. Selecting the Correct Needle

All Pfaff 3334 machines are regularly fitted with System 34 needles. To sew thicker fabrics on Model C machines, use a System 332 needle which is slightly longer than the standard needle.

The needle size should be selected in accordance with the thread size and the fabric weight. In any case, the thread must pass freely through the needle eye. As a general rule, select the needle as thin as possible, but not too thin to risk needle breakage in dense and resistant materials.

For best results, use a smooth, supple thread with a moderate twist.

Select the proper needle from the following table.

| Needle Size | Cotton | Silk | Synthetic | Linen |
|-------------|------------------------|-------|-------------|-------|
| 70 | 100/3 100/4 | 120/3 | 140/3–120/3 | |
| 80 | 80/3 80/4 | 100/3 | 120/3–100/3 | |
| 90 | 70/3–60/3 70/4–60/4 | 80/3 | 100/3– 80/3 | 70/3 |
| 100 | 50/3–40/3 50/4–40/4 | 70/3 | 70/3 | 60/3 |
| 110 | 30/3 30/4 30/6 | 60/3 | 60/3 | 50/3 |
| 120 | 24/3 24/6 | 50/3 | 50/3 | 40/3 |

Insert a new needle into the opening of the needle clamp and push it up as far as it will go. Make sure the long groove faces toward you.

7. Threading the Needle

Lead the thread from the spool up through the thread guide at the top of the thread stand, then down to spool pin 1 on the machine arm (Fig. 11). Pass it through the hollow pin, from top to bottom, thence below thread guide 2, over and from right to left around and between tension discs 3, clockwise around and between tension discs 4, over thread check spring 5, below thread guide 6, up and behind guide 7, from right to left through the hole in take-up lever 8, down and through thread guides 9 and 10, between thread nipper spring 11 and needle bar, and from front to back through the needle eye. Leave about three inches of thread hanging from the needle eye.

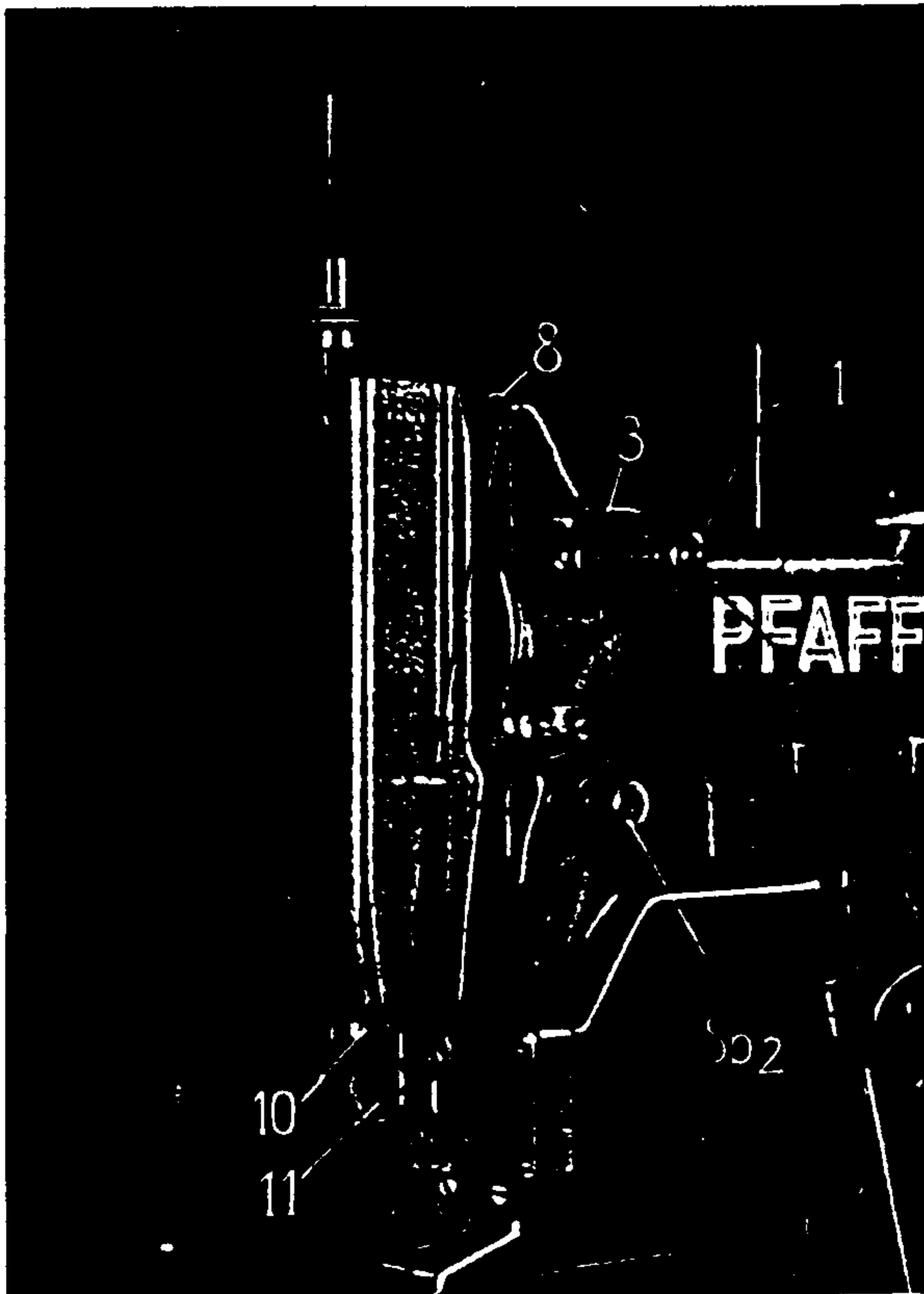

R 5798

Fig. 11

8. Regulating the Thread Tensions

The neat appearance of the finished bartack greatly depends on the correct regulation of tensions. Set the lower tension a little tighter than the upper tension so that the concatenation of threads will not be visible on the top side of the material and the thread will not kink on the underside. The following illustrations show how the tensions should be balanced.



Both threads are interlocked in the center of the material because both tensions are balanced correctly.



The bobbin thread pulls the needle thread to the underside of the fabric as the stitch is being formed.

Cause: Needle thread tension too weak, or bobbin thread tension too tight.

Remedy: Increase needle thread tension or decrease bobbin thread tension.



The needle thread pulls the bobbin thread to the surface of the fabric as the stitch is being formed.

Cause: Needle thread tension too tight, or bobbin thread tension too weak.

Remedy: Decrease needle thread tension or increase bobbin thread tension.

Regulating the Bobbin Thread Tension

Set the bobbin thread tension so that the bobbin thread will be pulled into the fabric correctly. Make sure, however, that the tension is not too light as otherwise the bobbin thread will not be cut.

The bobbin thread tension is regulated by the small screw **S** (Fig. 9), as follows:

Turn it right for tighter tension,
or left for looser tension.

The tension is correct if you have to overcome a noticeable resistance when pulling the thread.

Regulating the Needle Thread Tension

The Pfaff 3334-958/01 has two needle thread tensions. The top tension **Sp 1** (Fig. 11) controls the thread tension during the thread trimming action and should be set so that the thread is trimmed easily. If the tension is set too light, the knives will draw an excessive amount of thread through the tension and the needle thread will not be cut. If, on the other hand, the tension is too tight, the thread will be trimmed too early and too close to the needle eye.

The lower, or main, tension **Sp 2** (Fig. 11) controls the needle thread during the stitch setting phase. Begin by setting top tension **Sp 1** and then adjust main tension **Sp 2** so that the thread will be drawn into the material properly. In order to prevent that the fabric will be contracted by the first long stitches of the tack, the lower tension will not become operative until the machine has made three or four stitches. (This naturally applies only to tacks made on flimsy material and involving extremely long initial stitches). The main tension is released again before the last tying stitch is made so that a sufficient amount of thread can be pulled through the tension mechanism before the threads are trimmed.

9. Starting the Machine

Don't start the machine unless you have thoroughly familiarized yourself with its mode of operation.

When you depress the right treadle, the brake is released and the belt shifted from the loose to the driving pulley. This action starts the machine.

To acquaint yourself with the operation of the machine, turn the driving pulley by hand and study the individual phases of operation. Then thread the machine and try out the stitching on a piece of material.

While the machine is in operation, a locking mechanism prevents the work clamp from being raised and the knives from cutting the thread. Conversely, the machine cannot be started while the work clamp is raised.

10. Stopping the Machine

Upon completion of the sewing action, tripping lever **F 1** (Fig. 5) is depressed by the stop tripping segment on the rim of feed cam **W** and stop motion lever **R** pulled against the stop cam by a tension spring. At the same time, the belt shifter shifts the belt from the driving to the loose pulley to slow down the machine before it stops. Then the stop link snaps into the stop cam which stops the machine. The momentum of the machine is absorbed by double buffer springs. After the machine has stopped, the locking mechanism is released so that, by depressing the left treadle, the clamp can be raised and the threads cut.

If any trouble should occur while the machine is in operation, stop the machine by pressing down hand stop lever **A** (Fig. 5).

11. Trimming the Threads

The thread trimming knives are located on the underside of the needle plate. Shortly before the last stitch is made, main tension **Sp 2** is released. At the same time, knife cam **u** (Fig. 6) operates the vertical knife bar tripping lever and knife bar **M** and thereby causes the knives to be moved to the operative position. As the knives swing forward, the needle descends between them for the last stitch and the upper and lower threads are caught by the knife tips. The knives pull an adequate amount of thread through the upper and lower tensions to provide sufficient thread for the first stitches of the following tack. On completion of the last stitch, the machine stops automatically. At this stage, the take-up lever has almost reached the highest point of its stroke and the thread nipper is closed and traps the needle thread.

When the left treadle is depressed, the roller at the top end of the knife bar tripping lever drops into a recess in the control slot of the knife cam. This motion is transmitted to the knife bar and the knives which swing forward. As a result, the threads slide down from the knife tips onto the cutting edges and are trimmed. The thread wiper pulls the needle thread end up through the needle hole.

12. Feeding the Material

Since this machine has a rigid needle bar which does not swing sideways, the material is moved lengthwise and across the arm to form the desired tack design.

The feed motion is derived from the feed cam and conveyed to work clamp **D** and feed plate **E** (Fig. 12), between which the work is clamped. Depending on the subclass of the machine and the nature of the work to be performed, either a standard or a compensating work clamp is used.

The compensating work clamp (shown in Fig. 12) features two feet which yield independently against spring pressure so that each foot exerts the same amount of pressure on the material. It is used for conditions where the material is thicker on one side of the needle than on the other.

Eyelet-end buttonholes look nicer and wear longer if their square end is closed together before it is barred. For this purpose the Pfaff 3334-958/01-5 has been fitted with a special work clamp whose feet are spread apart when they reach the material and then are closed showing the fabric together toward the middle. The correct position of the bar is assured by a guide entering the buttonhole slot. This guide is located between the clamp feet.

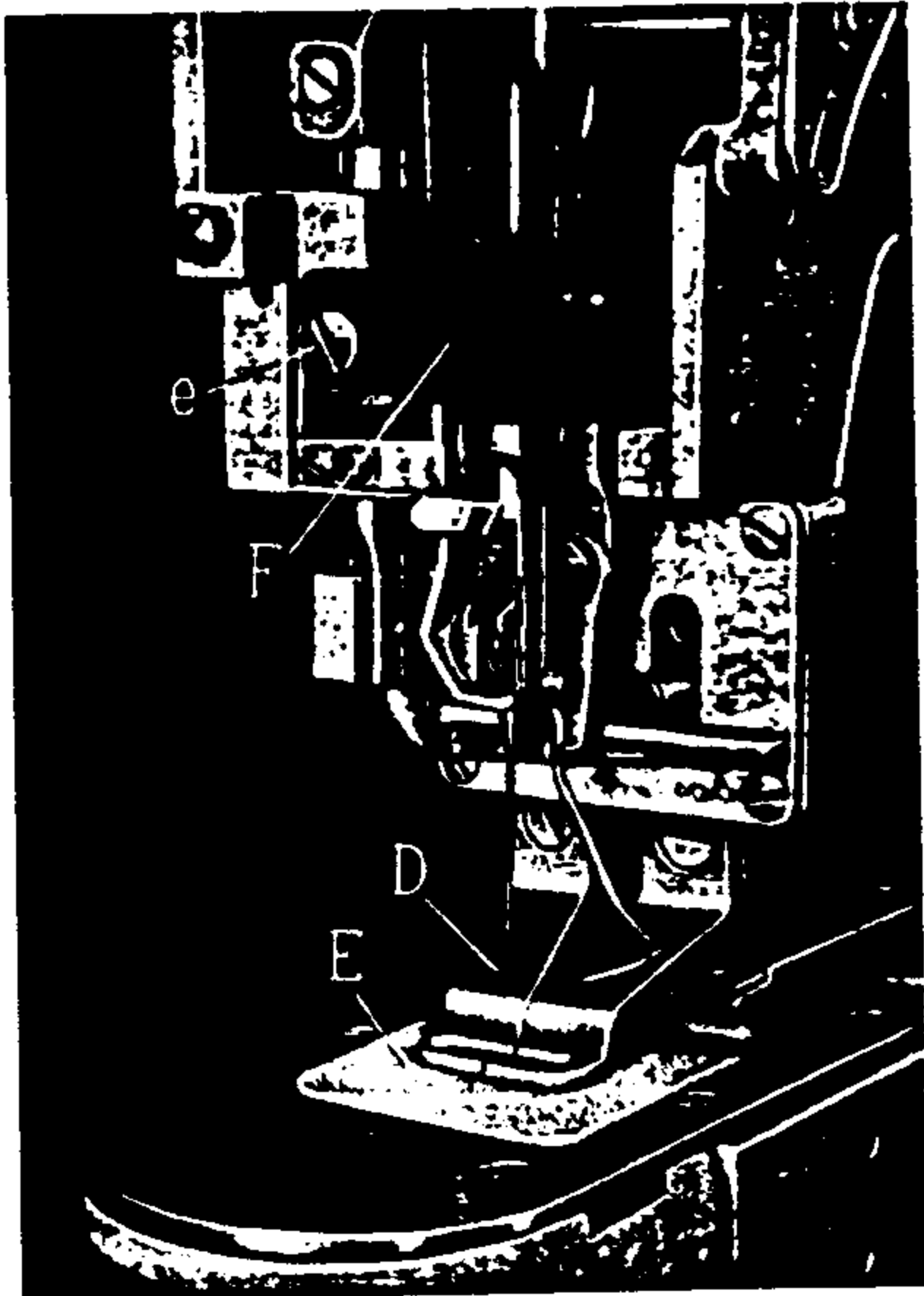

R 5797

Fig. 12

13. Regulating the Feed Across Motion

The amount of sideways travel of the work clamp depends on the design of the tack and varies with each subclass. To adjust the feed across motion, loosen wing nut F (Fig. 13) and move ball stud G in the slot of feed across regulator H, as follows:

Move it toward you for more sideways clamp travel, or over from you for less.

As a result of this adjustment, the stitches will be lengthened or packed more closely together, while the total number of stitches does not change. If the stitches are placed too far apart, the tack looks ugly. And conversely, if they are packed too close, particularly in leather or plastic material, the thread is likely to cut through the material. To facilitate correct adjustment, the maximum width of sideways travel has been limited in accordance with the style of tack made by each subclass.

R 5485

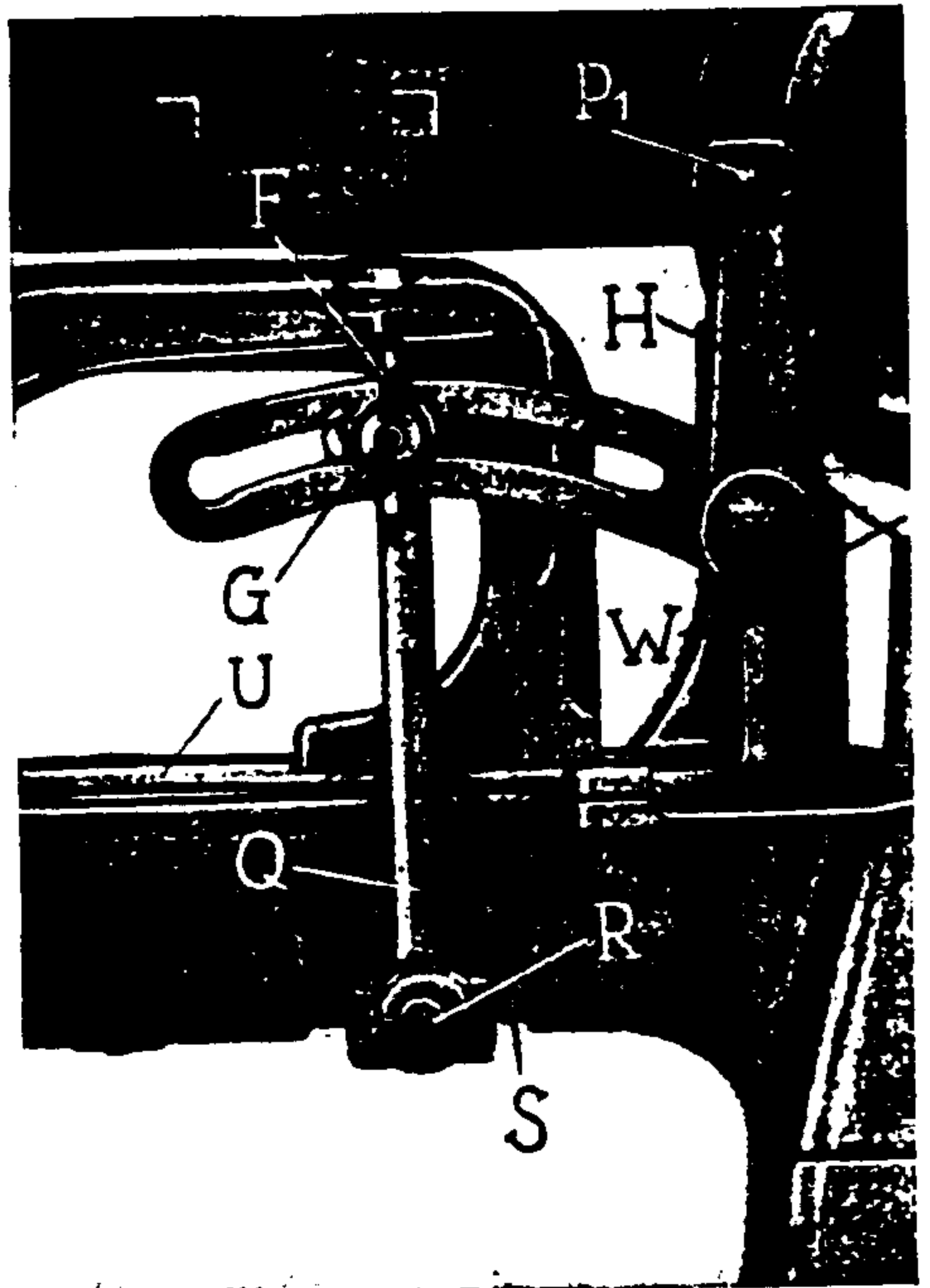

Fig. 13

14. Regulating the Feed Lengthwise Motion

The lengthwise clamp travel is derived from the control slot on the back side of the feed cam. This motion is conveyed to the work clamp by means of feed regulator **a** (Fig. 14), feed regulator post **K**, feed plate carrier **b** and arch clamp frame **L**.

To adjust the feed lengthwise motion, loosen screw **B** and move hinge block **J**, as follows.

Move it up as far as it will go to reduce lengthwise clamp travel to zero, or down to increase travel.

Note that for certain tack designs which are not actually bars, hinge block **J** must not be moved if the proportions of the design are to be preserved.

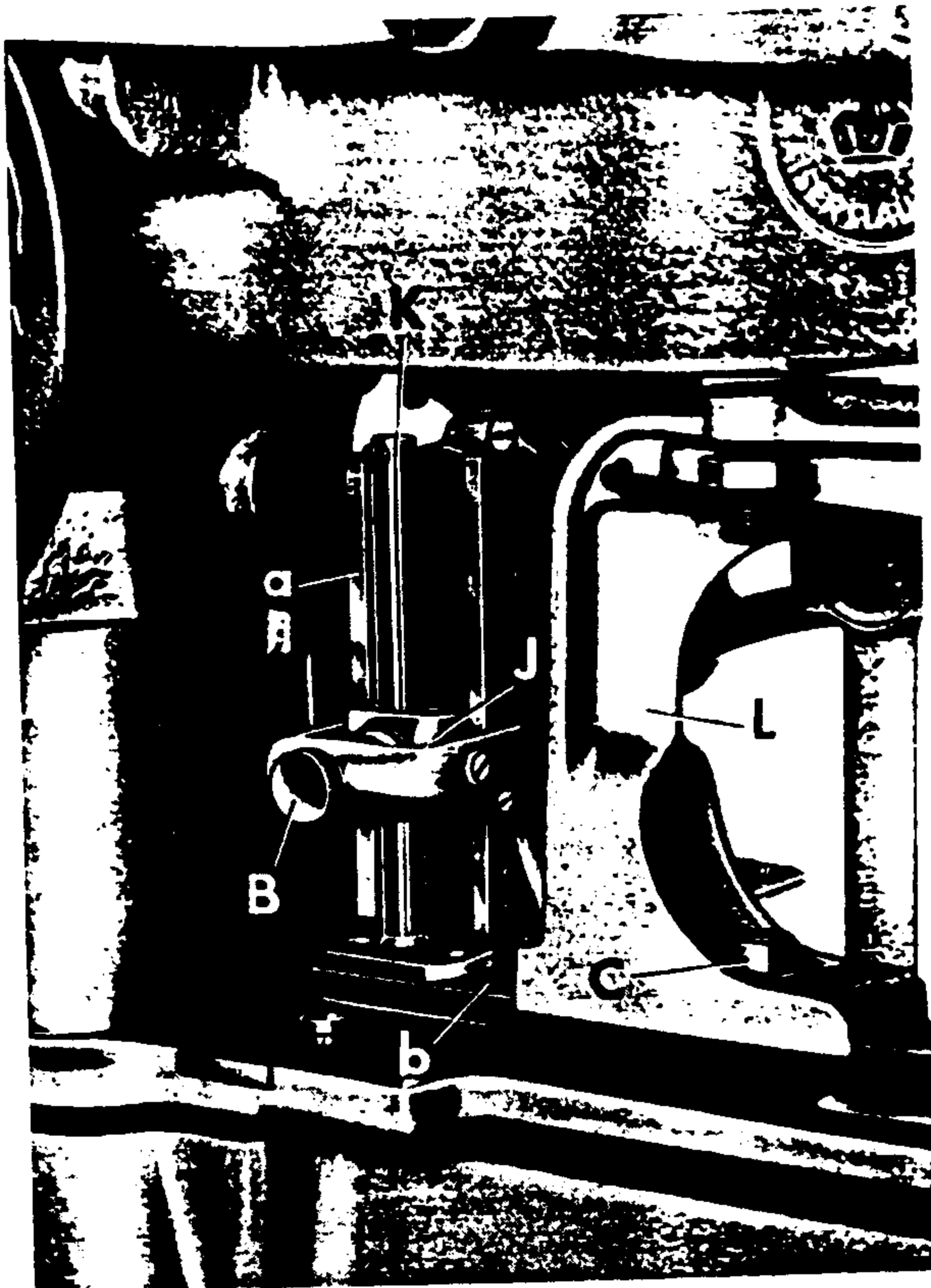

R 7576

Fig. 14

15. Dismantling the Shuttle Race

If the machine is used constantly, clean the shuttle race from time to time.

Let the machine run until it stops. Tilt it over to the left, resting it on the wooden peg. Open the cylinder bed cap, press down and pull it off. Remove the bobbin case and bobbin. Take out screws h and i (Fig. 15) and strip shuttle race ring d. Then, seize the shuttle by its center stud and pull it out. Take care that the springs on screws h and i don't get lost.

The shuttle race proper need not be stripped for cleaning. Take a pair of tweezers and remove pieces of thread that have accumulated in the area behind the shuttle race. Then, with a toothpick or similar wooden instrument, clean the raceway of the shuttle. Never use a metal tool for this purpose.

To assemble the shuttle mechanism, reverse the above procedure. Note that the point of the shuttle should point downward when you insert it. Don't forget to replace the springs on screws h and i and to put a drop of oil into the shuttle race after it has been re-assembled.

The springs on screws h and i hold the shuttle race ring in elastic suspension and prevent damage to the machine if thread should jam in the raceway. Pieces of thread or lint that should have entered the race can thus be easily removed.

R 5790

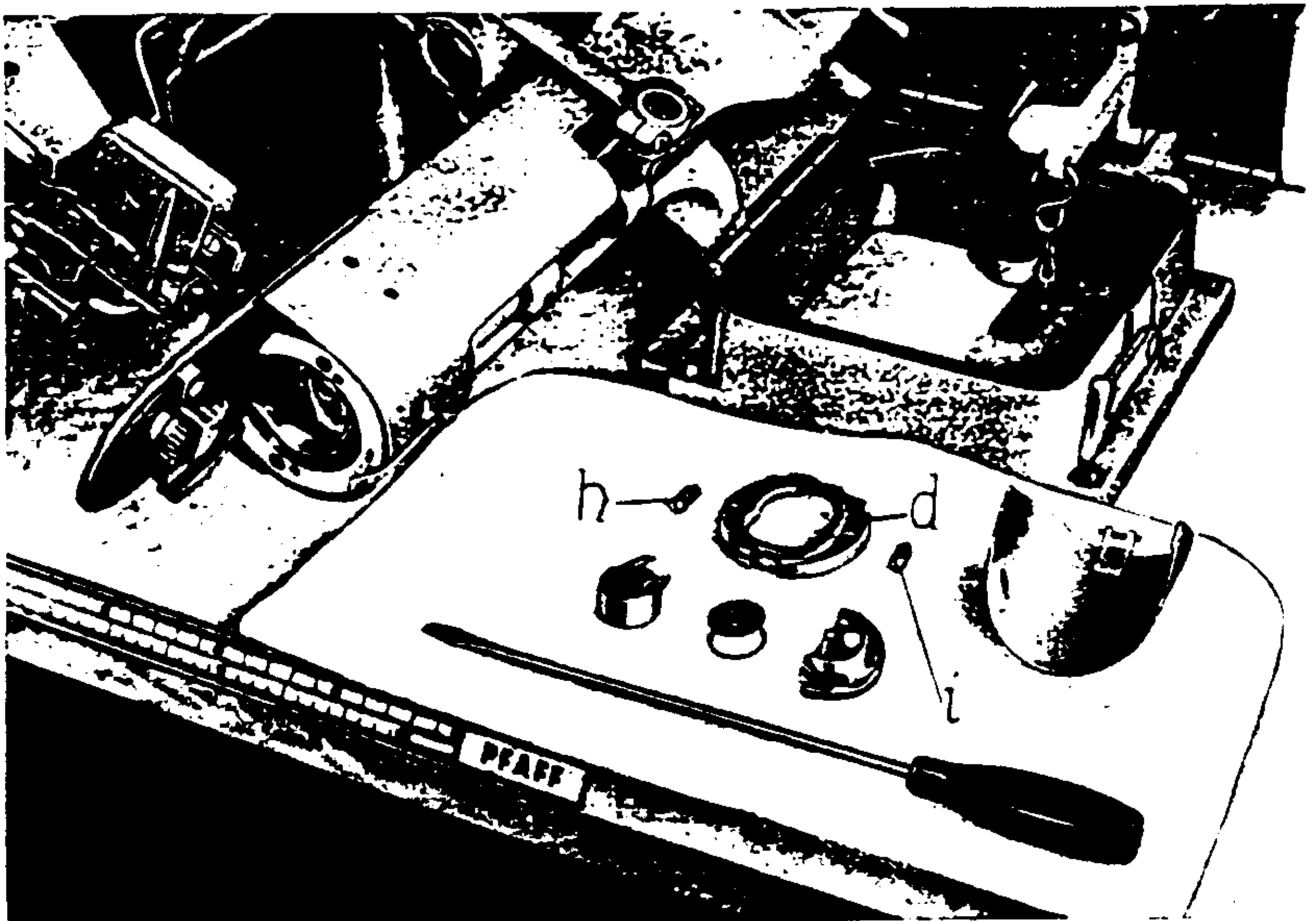

Fig. 15

B. Instructions for Mechanics

16. Centering the Needle in the Needle Hole

Needle bar frame F (Fig. 12) is hinged to a stud at its upper end and held in place by screw e, which passes through an elongated hole in the casting. To center the needle in the needle hole, loosen screw e and move the needle bar frame to the right or left, as appropriate.

The needle plate has an interchangeable insert. If the needle hole is damaged, loosen the two set screws and press the insert up out of its seat. In inserting a new insert, make sure the groove on its underside is exactly in line with the knife guide groove in the needle plate.

17. Timing the Shuttle

The Pfaff 3334-958/01 is fitted for a needle bar rise (amount of needle rise required to form the loop) of $\frac{3}{32}$ ", or 2.4 millimeters. To facilitate this adjustment, use the Pfaff needle rise gauge No. 88013605 which is available on special request.

In timing the shuttle, apply this rule: When the needle has passed the lowest point of its stroke and risen $\frac{3}{32}$ of an inch, the point of the shuttle should be just opposite the center line of the needle. This setting ensures proper loop formation.

If adjustment is required, loosen shuttle driver screws b_1 and b_2 (only b_1 visible in Fig. 21), which can be reached through holes a_1 and a_2 on the underside of the cylinder arm. The shuttle driver crank is pinned to the rear end of the shuttle driver shaft so that its position on the shaft cannot be adjusted.

Setting the Needle Bar at Correct Height

See that the point of the shuttle is opposite the center line of the needle after the latter has passed the lowest point of its stroke and risen $\frac{3}{32}$ of an inch. When in this position, the point of the shuttle should be $\frac{1}{16}$ " (1.5 millimeter) above the top of the needle eye. If adjustment is required loosen the clamping screw, which fastens the needle bar connecting stud to the needle bar, and move the latter up or down, as appropriate.

To double check the above settings, bring the needle to the lowest point of its stroke and see if the bottom of the needle eye is flush with the top of the shuttle driver when the latter is at its right point of reversal. Also check if the amount of needle rise is the same whether the driving pulley is turned clockwise or counter-clockwise. Both the shuttle driver and the needle bar should reach their points of reversal at exactly the same time.

18. Adjusting the Crosswise Clamp Travel

The feed across motion is derived from the slot on the front of feed cam W (Fig. 13). As the roller on stud P_1 follows the channel track, the throw which is initiated by the curvature of the slot is conveyed to feed across regulator H, connection Q, ball stud R, feed across shaft S and feed plate carrier U, and causes the latter to move crosswise of the cylinder arm.

Adjust the feed across motion so that the right and left hand ends of the feed plate slot are equidistant from the needle hole when the feed plate is at the extreme right or left of its throw. Check this setting for the longest and the shortest feed across motion.

All motions should be timed very carefully. Once the correct setting has been obtained, no further adjustment should be made, unless absolutely necessary.

If readjustment is required, proceed as follows:

1. After the machine has completed the sewing cycle and stopped, loosen the nut on roller stud P_1 (Fig. 13) and center the stud in the elongated hole of feed across regulator H . Tighten the nut securely.
2. Move ball stud G (Fig. 13) toward you as far as it will go, setting clamp and feed plate for the longest crosswise travel.
3. Push the belt shifter over from you to release the brake.
4. Turn the driving pulley and check whether the right and left hand ends of the feed plate slot are equidistant from the needle hole when the feed plate is at the extreme right or left of its throw. If adjustment is required, loosen screw l_1 and binding screw m (Fig. 16) and set the feed plate, as appropriate. Then tighten both screws securely.
5. Move ball stud G (Fig. 13) over from you as far as it will go, setting clamp and feed plate for the shortest crosswise travel.
6. Repeat the check outlined in par. 4 above. If adjustment is required, loosen screws l_2 and n (Fig. 16) and move stud R lengthwise of the feed across shaft until the crosswise travel of the work clamp is exactly halved by the needle. To double check this setting, move ball stud G (Fig. 13) from one end of the slot in regulator H to the other and make sure the feed plate does not move sideways.

If the feed plate should move sideways in spite of this minute adjustment, move stud P_1 (Fig. 18) slightly to the right or left in the elongated hole of feed across regulator H .

R 5782

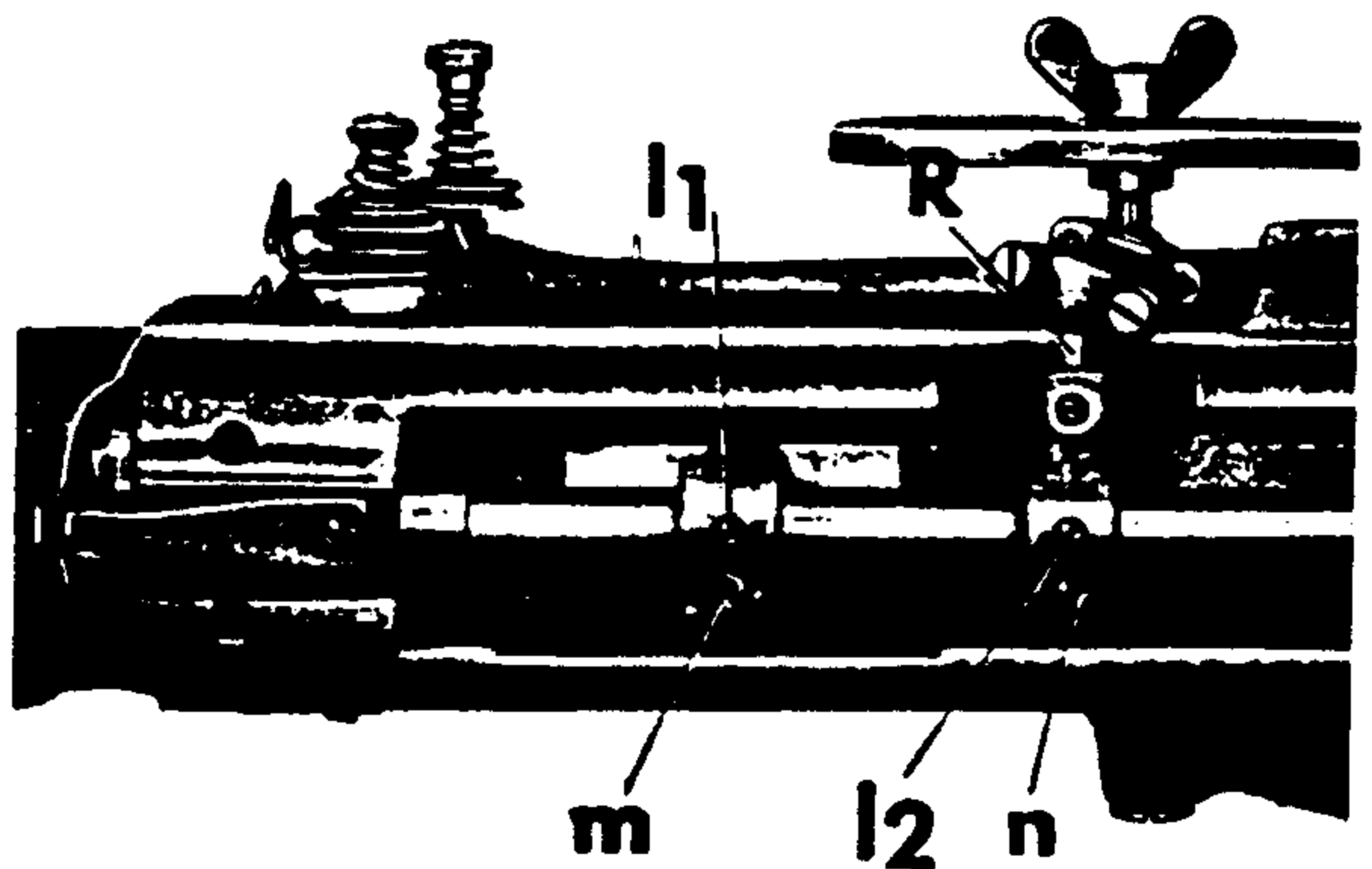

Fig. 16

19. Adjusting the Lengthwise Clamp Travel

The feed lengthwise motion is derived from the control slot on the back of feed cam **W** (Fig. 17). Motion is transmitted from the roller on stud **P₂** to feed regulator **V**, hinge block **J** (Fig. 14), feed regulator post **K**, feed plate carrier **b** and the work clamp.

To adjust the lengthwise clamp travel, move hinge block **J** downward as far as it will go. Turn the driving pulley by hand and check whether the needle hole remains within the clamp feet slot when these feet reach the extreme positions of their lengthwise travel.

If the machine makes a bar-type seam, also check whether the plain stitches in the design are correctly centered over the long stitches. To check this, place a piece of stiff paper under the clamp and examine the stitch pattern.

For a precise adjustment of the feed lengthwise motion loosen the nut on stud **P₂** (Fig. 17) and move the stud in the elongated hole of feed regulator **V**, as required. Then tighten the nut securely.

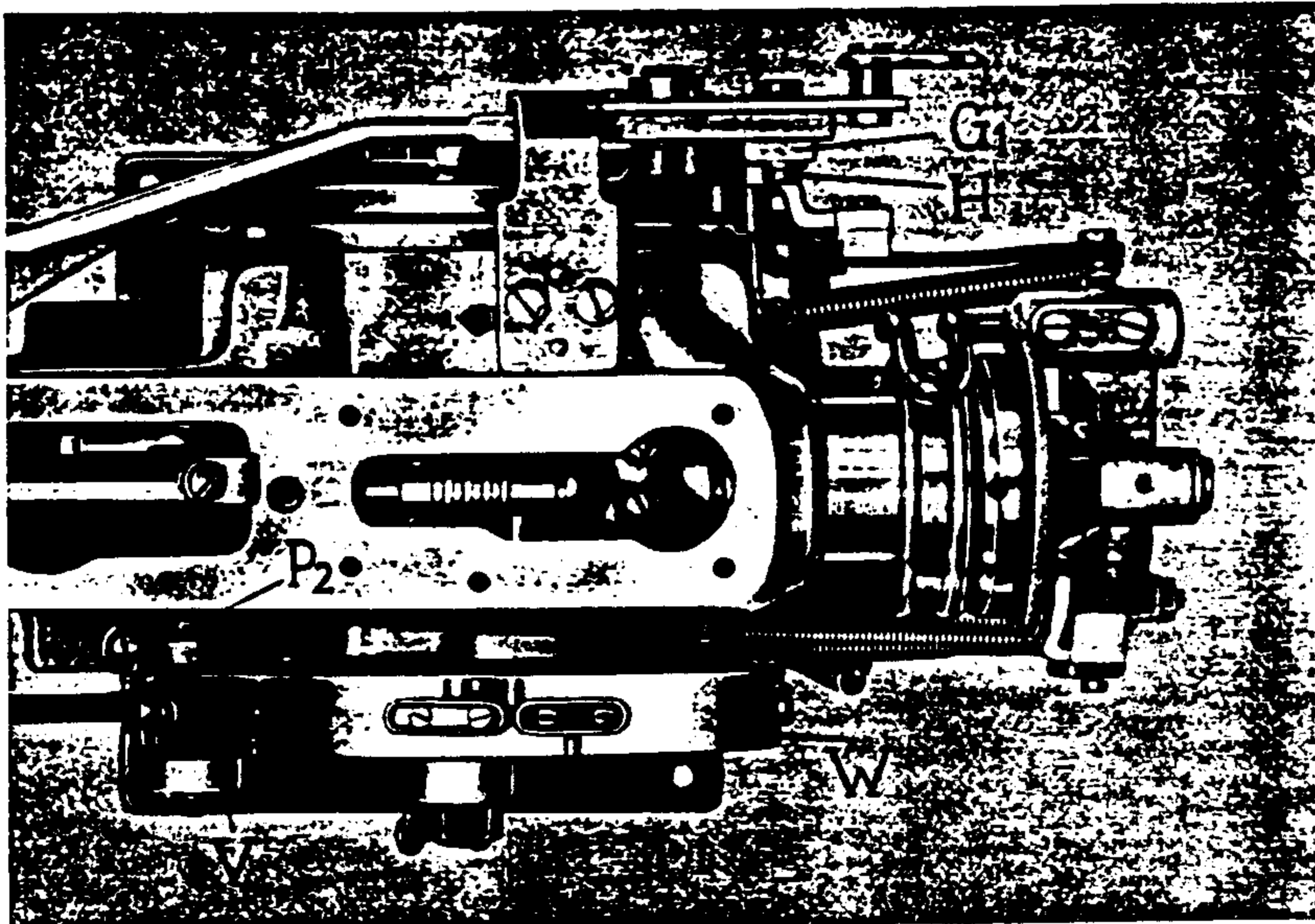

R 5783

Fig. 17

20. Timing the Feed Cam

The feed cam is located on the right hand side of the machine arm (as seen from the operator). It controls both the feed lengthwise and the feed across motions. The feeding motion begins after the needle has risen clear of the fabric and ends before the needle penetrates the material again. If the feeding begins too early or ends too late, the feeding motion is retimed by turning the cam on its shaft.

To do this, loosen nut Y (Fig. 18) and stud X and turn the feed cam on the transverse shaft (the cam can be turned within the limits set by stud X riding in the elongated hole in cam positioning block Z). After the adjustment, tighten stud X and nut Y securely.

R 5793

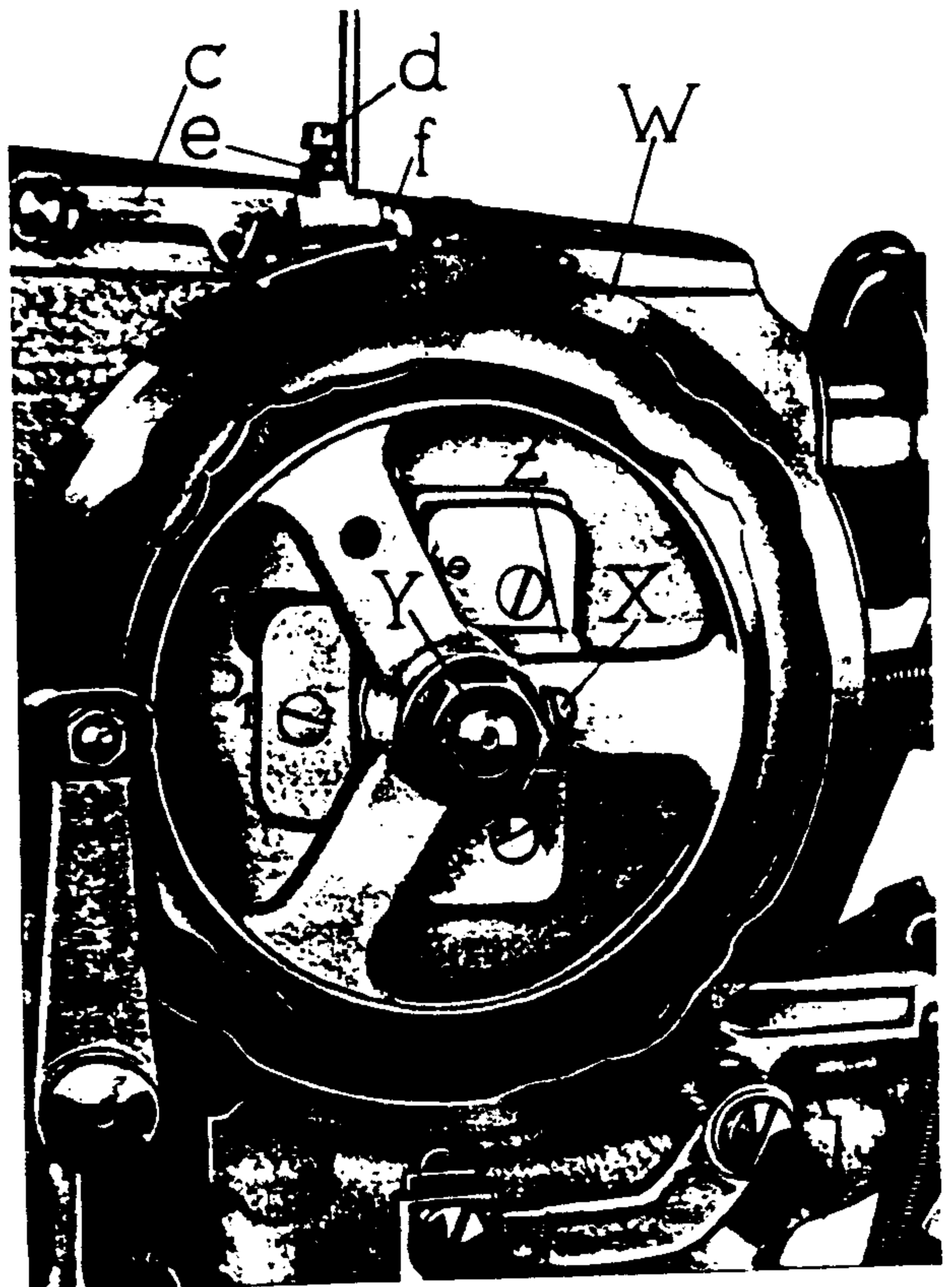

Fig. 18

22. Adjusting the Knife Bar

The throw initiated by knife cam **u** (Fig. 19) is transmitted to the knives below the needle plate by means of tripping lever **t** and knife bar **M**.

The knife bar carries a rack at its front end which meshes with the knife carrier pinion. Its rear end is connected to tripping lever **t** by means of an adjustable fork.

Loosen screws **r** and **s** (Fig. 19) and set knife bar **M** so that there is a clearance of about $\frac{9}{32}$ "— $\frac{5}{16}$ " (7–8 millimeters) between tip of bobbin thread knife **U** and the needle hole when the knife is inoperative (Fig. 20).

No gauge is required for this setting. Simply adjust the knife bar until the tip of the bobbin thread knife is in line with the top left edge of the shuttle race. Note also the instructions given in the preceding chapter.

R 5951

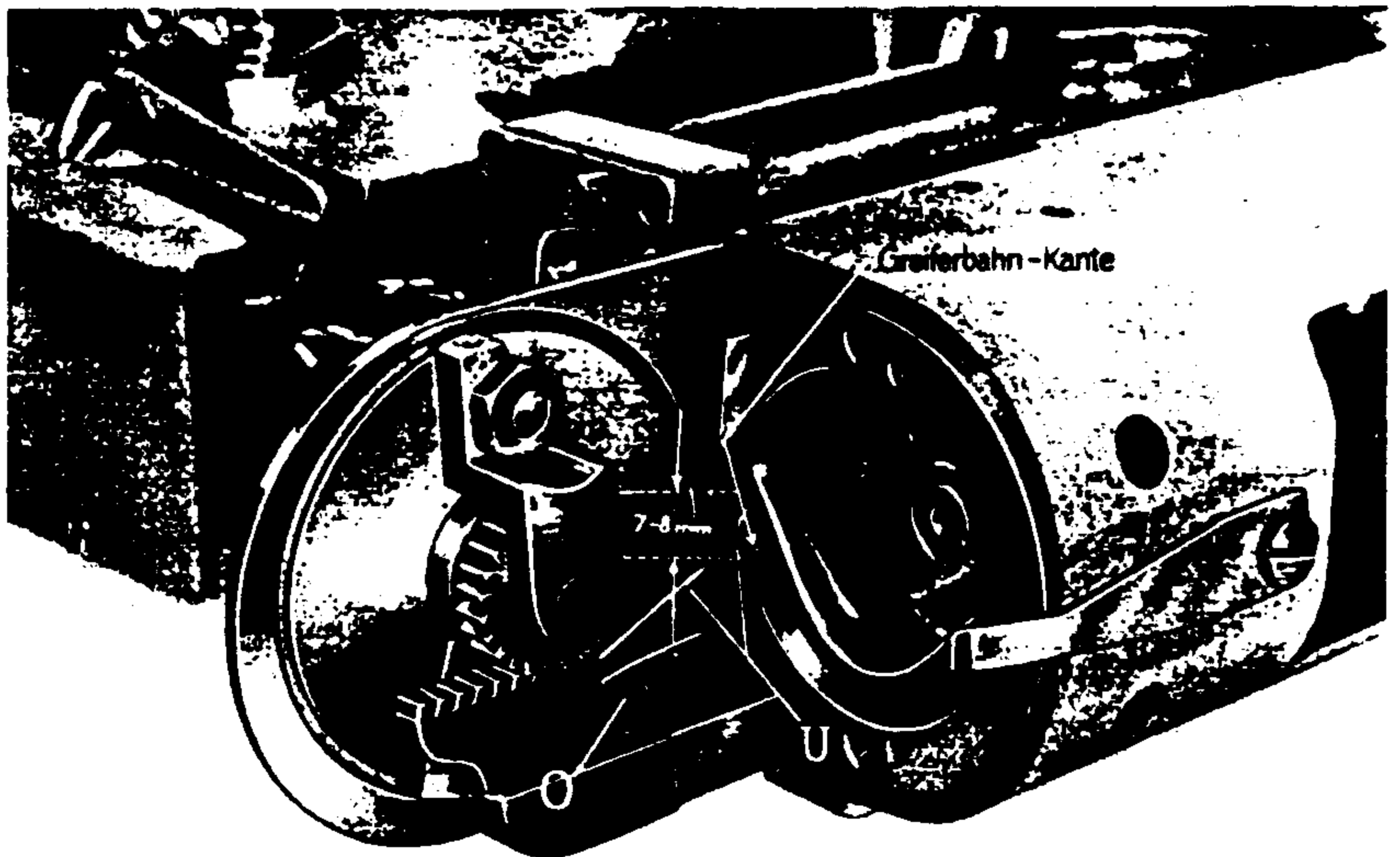

Fig. 20

21. Timing the Knife Cam

Shortly before the machine stops, the knife cam causes the knives to be moved from the inoperative to the operative position, and after the machine has stopped, operates tripping lever *t* (Fig. 19) and knife bar *M*. Knife cam *u* is screwed to hub cover *f* which, in turn, is pinned to the transverse shaft.

The four screwholes in hub cover *f* are elongated so that the position of the knife cam on the shaft can be adjusted after loosening the four screws *q*.

Set the knife cam so that knife motion begins when the needle has passed the highest point of its stroke and begins to descend for the last stitch. Since gear ratios vary with each subclass machine, no hard and fast rule can be given for the elimination of minor deviations. If additional adjustment is required, reset the knife bar as instructed in the following chapter. Note as a general rule that the needle should pass between the knife tips when it descends for the last stitch of one seam and the first four stitches of the next seam.

R 7589

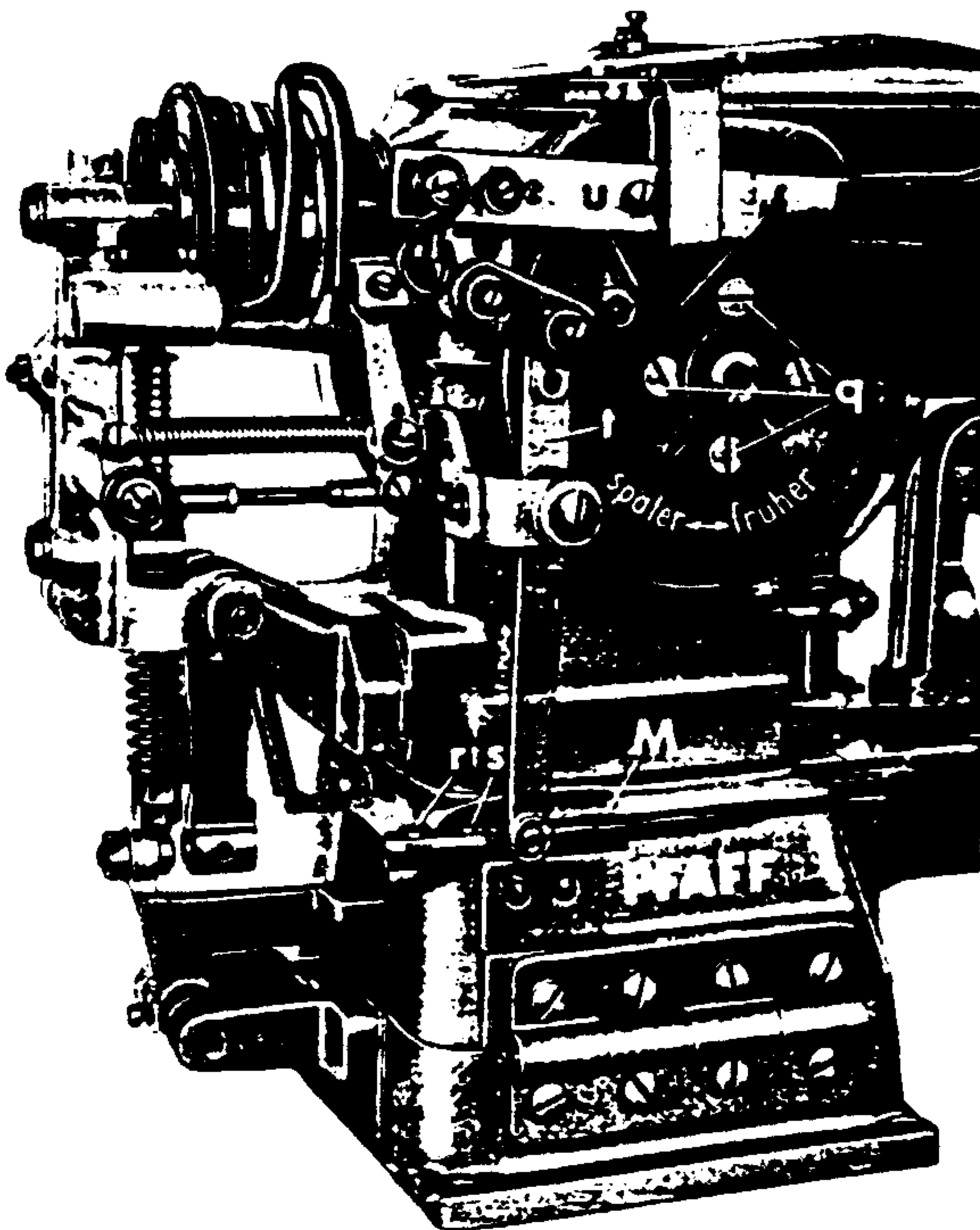
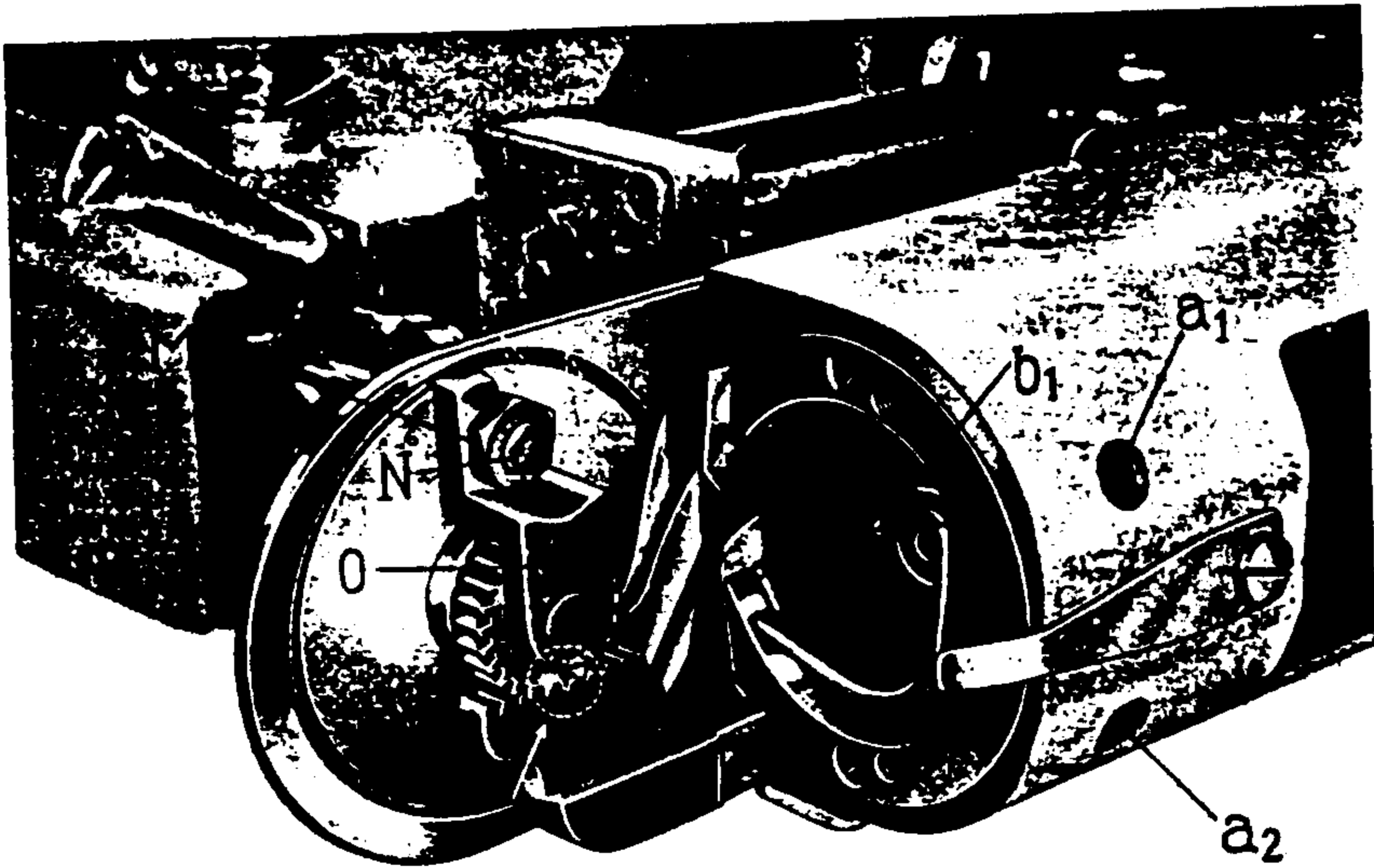

Fig. 19

23. Changing the Knives

The knives should be sharpened from time to time, particularly when the machine is used constantly. To strip the knives, tilt the machine over to the left and rest it on the wooden peg. Open the cylinder bed cap, loosen nut M (Fig. 21) and take out screw N. Next, remove pinion stud bracket O and the knife assembly.

The knife assembly can also be removed from above. To do this, loosen hexagon screw b (Fig. 22) in the feed plate and pull the plate out of its mount. Then take out the four needle plate screws and remove the needle plate with the attached knife assembly by pulling it forward.



R 5952

Fig. 21

The knives are secured to the knife carrier only by screw a (Fig. 22). Take out this screw and strip the knives. Sharpen them with a knife grinder or exchange them for new knives.

In replacing the knives make sure they fit in the knife carrier groove correctly. Then tighten screw a securely. The meshing teeth of the rack and the pinion are spotted (Fig. 21) so that the knife bar need not be readjusted after the knife assembly has been replaced. To replace the knife assembly in the machine simply reverse the above procedure.

R 5789

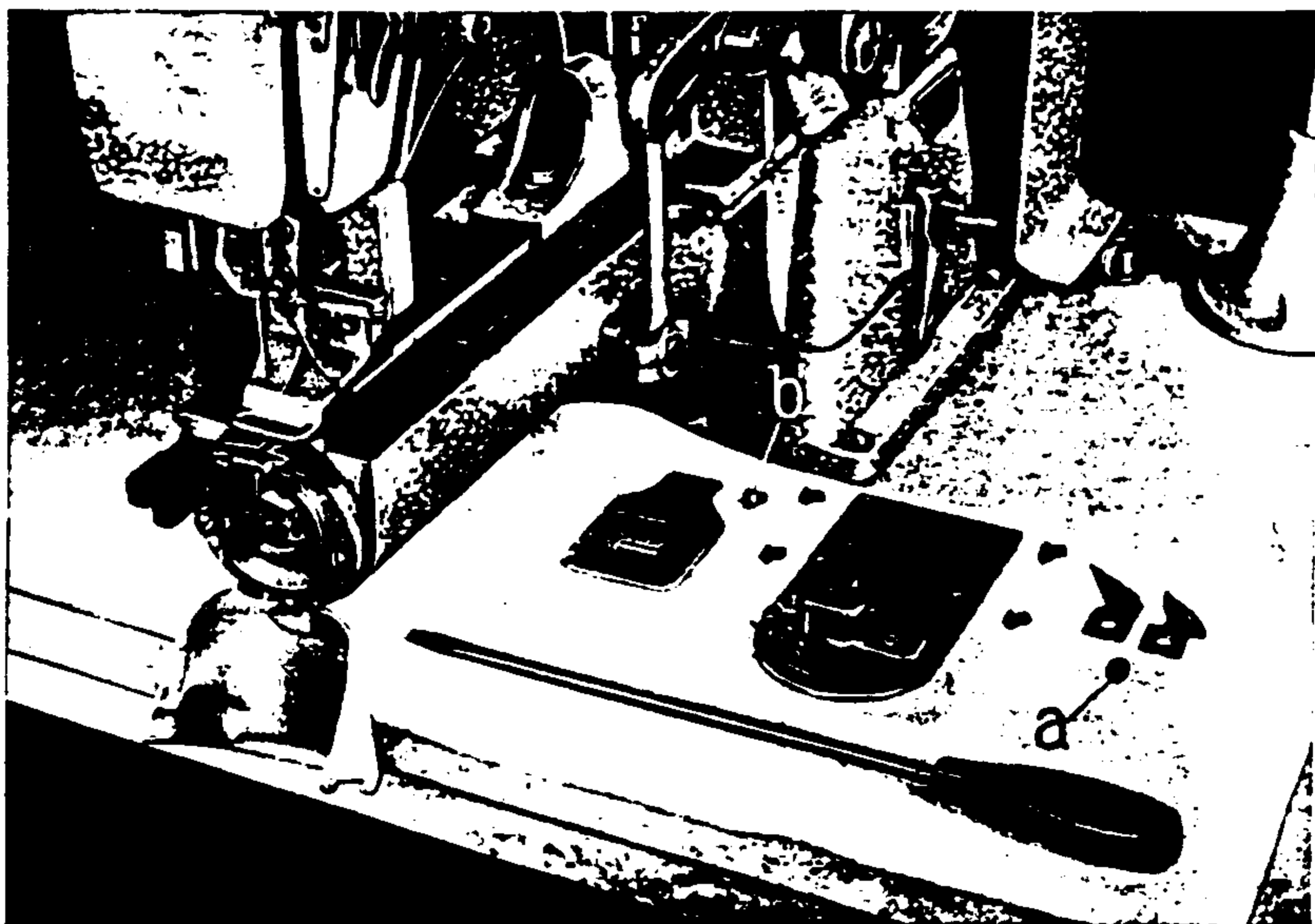

Fig. 22

24. Adjusting the Knife Motion

When you depress the left treadle after the machine has stopped, the knives swing forward to the operative position. During this operation the tip of the bobbin thread knife may swing slightly beyond the right edge of the cylinder arm, but it should be flush with this edge when the treadle is depressed completely.

If the knife protrudes from the edge, loosen lock nut H (Fig. 17) and adjust the position of regulating block G₁ in the slot of the lifting lever.

25. Adjusting the Stop Motion Lever

Stop motion lever **p** (Fig. 23) carries a catch, **E₁**, at its lower end, which can be adjusted vertically. The spring-loaded tripping lever **F₁** carries an adjustable latch, **G₁** at its rear end.

Both the catch and the latch should be so adjusted that latch **G₁** will leap about halfway into the upper notch of catch **E₁** when the right treadle is depressed to start the machine. To adjust, loosen the hexagon screws.

When you make this adjustment also see that there is a clearance of about $\frac{5}{64}$ " (2 millimeters) between the face of the stop link (Fig. 24) and the highest point on the face of the stop cam. If adjustment is required, loosen screw **t** (Fig. 23) and reset latch **G₁** in the groove of tripping lever **F₁**.

R 5485

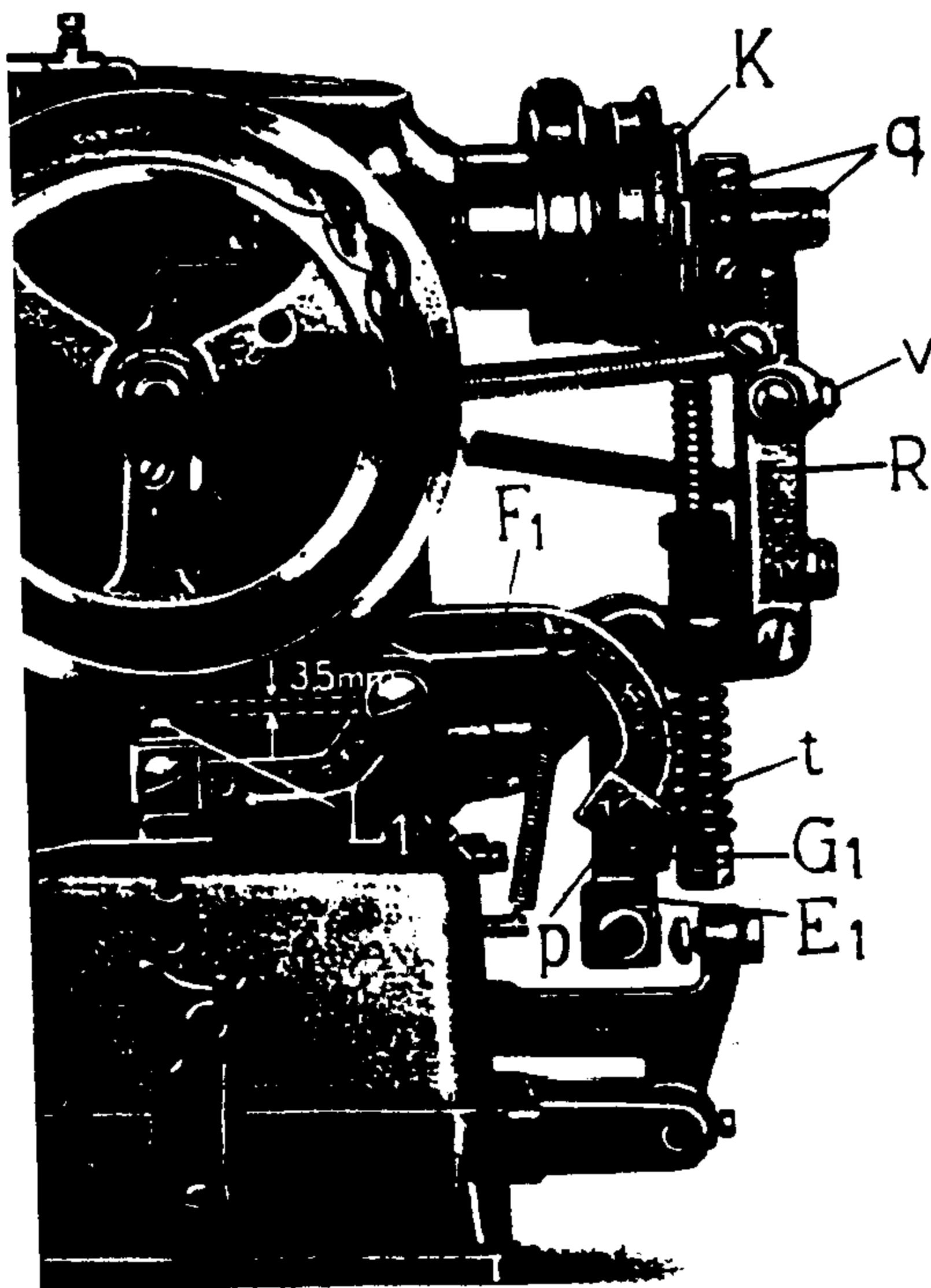

Fig. 23

26. Adjusting the Brake Lever of Machines with Round-Belt Drive

Adjust brake lever R (Fig. 23) so that there is a clearance of about $\frac{9}{32}$ " (7 millimeters) between hinged brake shoe K and the braking surface of the driving pulley when the machine is in operation. Also make sure the brake lever can be pulled off the pulley $\frac{5}{64}$ " (2 millimeters) when the machine has stopped.

To adjust, follow this procedure:

Start the machine by hand. Loosen the two screws q (Fig. 23), set hinged brake shoe K in the central position and tighten both screws securely.

Loosen the nut of stop screw v and turn the screw out until it turns freely, without any resistance. Then turn the screw in one or two turns.

Stop the machine completely so that the stop link snaps into the groove of the stop cam. Check whether the brake lever can be pulled off the pulley about $\frac{5}{64}$ " (2 millimeters) against spring pressure.

If further adjustment is required, loosen the two screws q and move the brake shoe back accordingly.

Make sure the brake shoe exerts a sufficient amount of pressure on the braking surface of the driving pulley when the machine is being stopped.

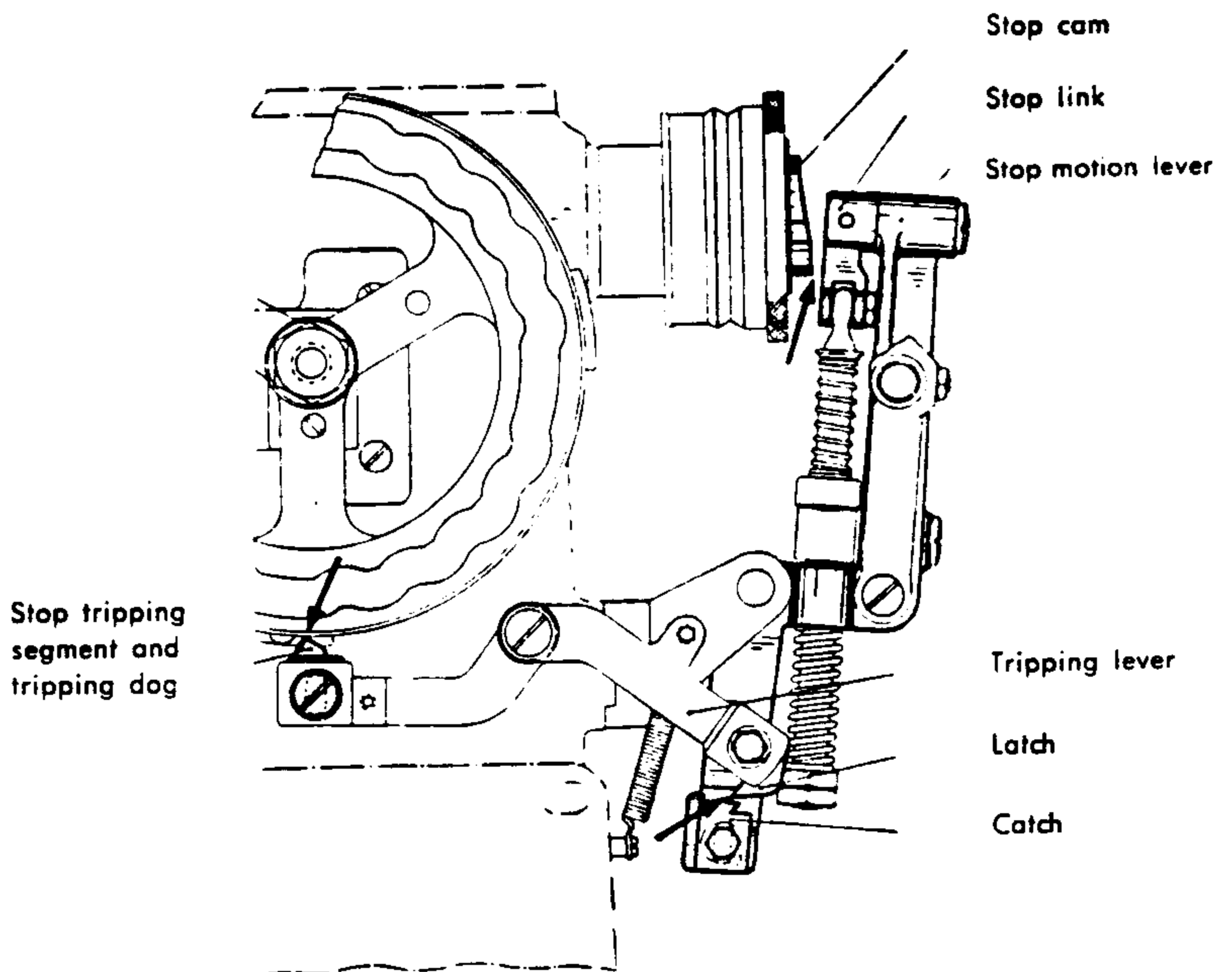

Fig. 24

27. Adjusting the Tripping Lever

Tripping dog L_1 (Fig. 23), which is located at the front end of the tripping lever, can be adjusted vertically. Set it so that the stop tripping segment on the rim of the feed cam depresses the tripping dog far enough to ensure that the machine will be stopped securely. As a general rule, there should be a clearance of about $\frac{1}{8}$ on an inch (3.5 millimeters) between the tripping dog and the rim of the feed cam when the machine has stopped (Fig. 23).

28. Adjusting the Stop Tripping Segments

The number of stop tripping segments which are arranged on the rim of the feed cam varies with each subclass and ranges from 1 to 6.

To adjust the stop tripping segments, proceed as follows:

Turn the driving pulley until the tripping segment to be adjusted (M_1 in Fig. 5) has just passed tripping dog L_1 (Fig. 23) and the stop link has snapped into the groove of the stop cam. When the machine has stopped, tripping dog L_1 should be positioned just behind the stop tripping segment, without touching it. On restarting the machine, tripping dog L_1 should contact the rim of the feed cam instantly.

If the stop tripping segment needs adjustment, loosen the two screws n (Fig. 5) and move the segment back or forth on the rim of the cam, as required.

If the feed cam has more than one stop tripping segment, each has to be set separately.

29. Timing the Thread Nipper

The needle thread must be trapped when the machine stops. If this condition is not met, adjust by loosening screw e (Fig. 18) and moving finger f on tripping lever c as follows:

Toward you ← Needle thread is trapped earlier

The finger is positioned correctly if its tapered side just slips over the front edge into the recess on the rim of the cam when the machine stops.

Another rule that must be observed is that the needle thread must be released before the needle has reached the lowest point of its stroke when making the first stitch. As the sewing cycle continues, the thread should remain loose until the take-up lever has reached a point about $\frac{9}{16}$ " (15 millimeters) below the highest point of its stroke. This condition also applies to the initial phase of the second stitch, whereas for all successive stitches the thread nipper remains inactive.

If the above condition is not met, adjust by loosening the two set screws and moving thread nipper tripping segment h (Fig. 18), as follows:

Over from you → Needle thread is released earlier

Although the correct pressure of the thread nipper is normally established by trial and error, the following rule may be helpful:

The pressure is correct if the thread can just be pulled through the thread nipper without breaking.

The pressure is regulated by stop screw *d* (Fig. 18). Some bartacks which feature very long crosswise stitches (without intermediate stitches) require a sufficiently long end of thread with which to begin the tack. On machines making such tacks finger *f* should be pushed back slightly so that it can fall earlier into the recess on the rim of the cam. If there are several thread nipper segments arranged on the feed cam, each has to be adjusted separately.

30. Changing the Buffer Spring

A powerful buffer spring is located in the hollow driving pulley and serves to absorb the momentum of the machine when it stops. If the spring works correctly, the machine is slowed down first and stopped only when the needle bar has passed the highest point of its stroke and descended $\frac{1}{8}$ "– $\frac{3}{16}$ " (3–5 millimeters) and the take-up lever

R 5791

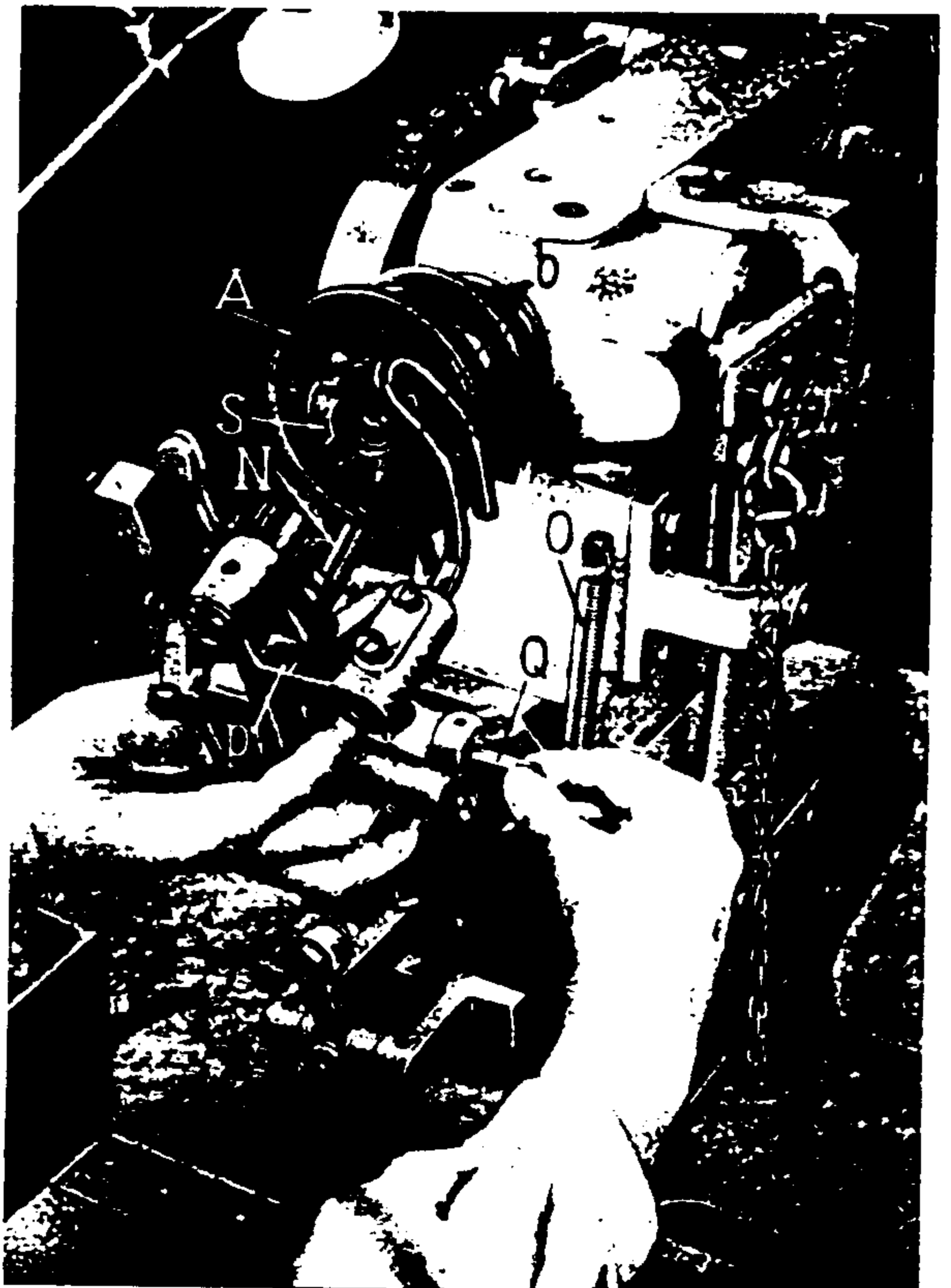

Fig. 25

has almost reached the top of its stroke. Since this spring is subjected to excessive stress, it may become weak or even break after some time by fair wear and tear. This becomes evident when the machine ceases to stop evenly or when the needle bar and the take-up lever do not always stop at the same positions. As a result, the needle may stop before it has reached the top of its stroke and may be broken by the thread wiper upon lifting the work clamp. To correct this and similar conditions, exchange the buffer spring, as follows:

Remove tension springs N and O (Fig. 25), loosen screw K (Fig. 26), pull out hinge stud Q and strip stop motion lever p (Fig. 25) and brake lever R.

Next, take out the four screws b, strip cap ring A and remove stop cam S and the broken buffer spring.

Insertion of a new spring is greatly facilitated by the use of a special wrench (Fig. 27) which will be supplied by us on special request.

R 5782

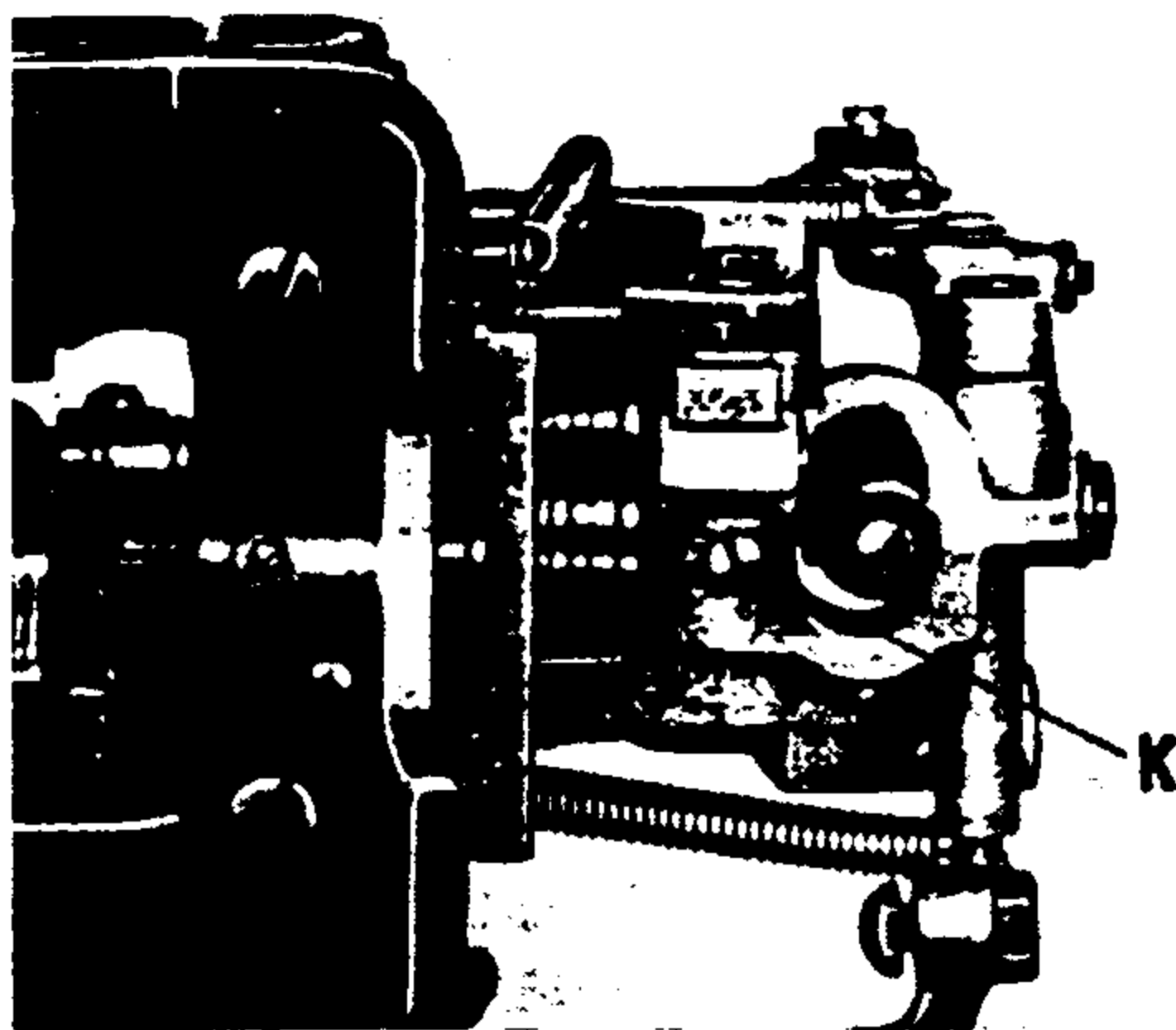

Fig. 26

Proceed, as shown in Fig. 27, by inserting a suitable punch into hole I of the driving pulley. Then rotate the pulley until punch D rests against the bearing bracket.

Insert the buffer spring into the receptacle, place the loose check block on the stud of the wrench, and push the wrench over the end of the arm shaft, with the loose check block contacting the loose end of the spring. Now, with the wrench in your left hand, compress the spring and place the Novotext segment between both check blocks. Make sure the flat sides of the check blocks face toward the segment.

Then replace the stop cam and the cap ring and screw them down. Attach the brake lever and the stop motion lever.

R 5788

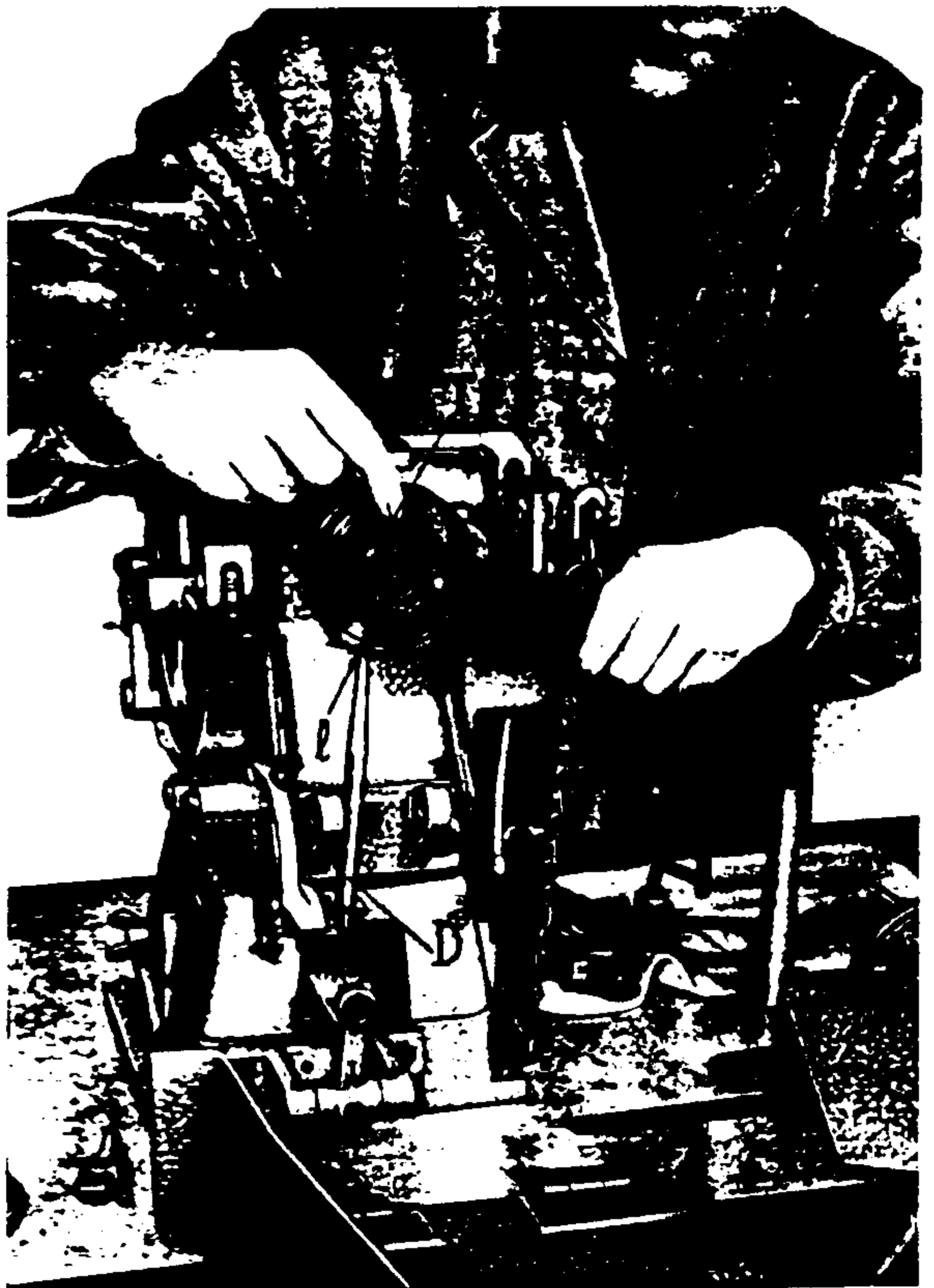

Fig. 27

31. Adjusting the Cone Clutch of Machines with V-belt Drive

To adjust the clearance between V-belt pulley (idler pulley) 1 and drive pulley 7 after the machine has stopped, loosen the nut of eccentric 5 and turn the eccentric to the right or left by hand until the forked clutch lever 3 has pushed the ball-bearing collar of the V-belt pulley against the arm shaft bearing. Hold the eccentric in this position with an open-ended spanner and tighten its nut.

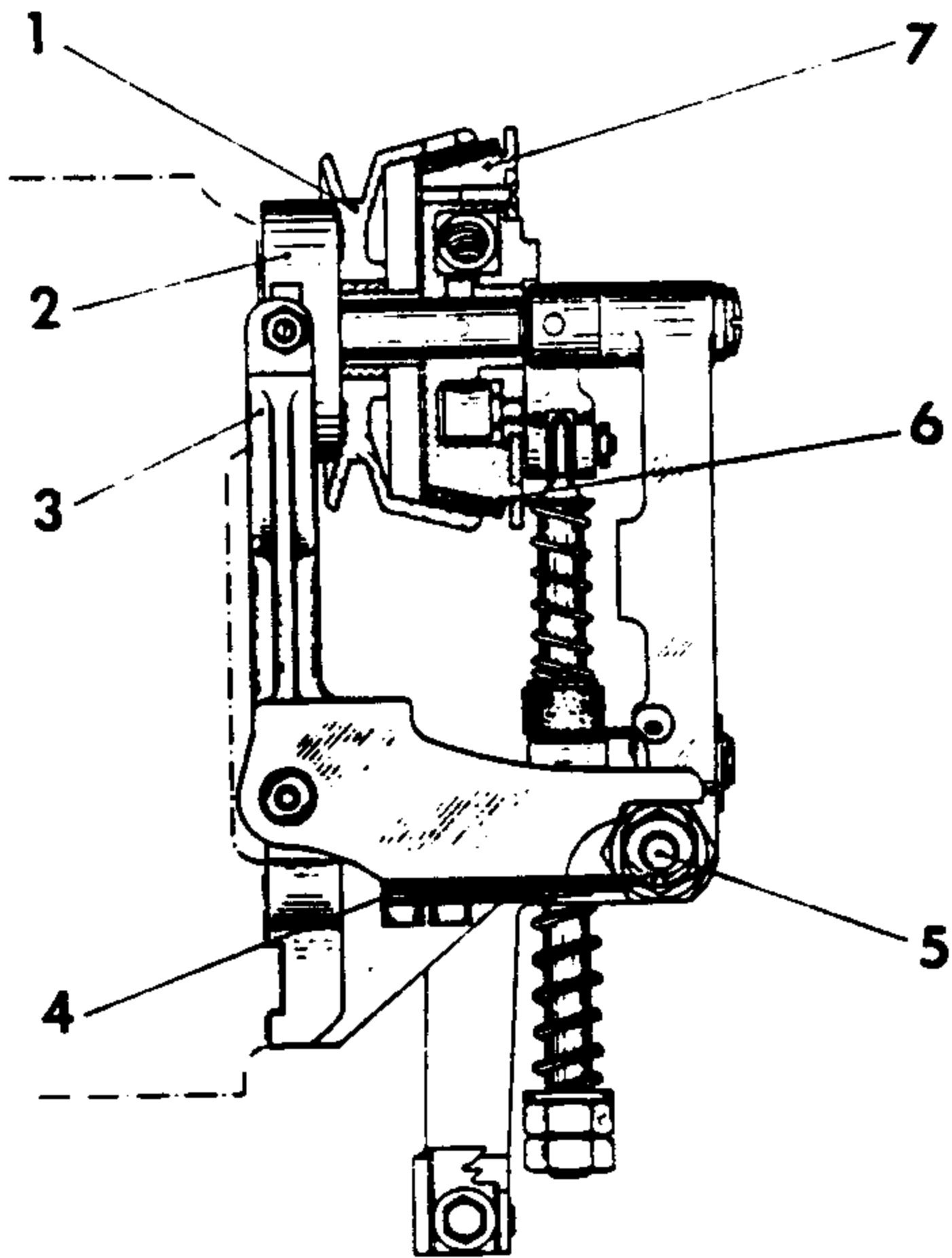

Fig. 28

- 1 = V-belt pulley (idler pulley)
- 2 = Engaging and disengaging collar
- 3 = Forked clutch lever
- 4 = Leaf spring
- 5 = Adjusting eccentric
- 6 = Clutch lining
- 7 = Drive pulley (take-up spring housing)

32. Trouble Shooting

Sewing troubles should rarely occur if all the instructions given in this book are carefully followed. If trouble should nevertheless occur, the following hints will help you locate the fault.

Machine Skips Stitches:

1. Needle bent.
2. Needle incorrectly inserted.
3. Needle too fine for the thread.
4. Needle rise inaccurately timed, or needle set too high or too low.
5. Shuttle set too far away from needle.

Thread Breaks:

1. For any of the causes enumerated above.
2. Needle point blunt or worn, or burrs and sharp edges on needle plate.
3. Thread caught between tension discs.
4. Poor or knotty thread used.
5. Thread tensions too loose or too tight.

Needle Breaks:

1. Needle bent.
2. Needle too fine for the fabric, or deflected by hard spots in the material.
3. Buffer spring broken.
4. Knives improperly timed.
5. Machine feeds while needle is down in material.
6. Work clamp not in line with needle so that needle strikes buckle or clasp to be sewn on.

Machine Works Heavily:

1. Lack of oil.
2. Mechanism clogged by inferior lubricants.
3. Pieces of thread jammed in shuttle race.
4. Machine or line shaft belt too long.

The method of function and the essential adjustments of these machines are the same as the 3334. This means that the service manual for the Pfaff 3334 can, for the greater part, be used for the above-mentioned machines.

The following adjustments differ from those of the 3334:

1. Increasing the lateral motion: move stud A downwards in its adjustments slot. To do so, loosen nut B.
2. Decrease the lateral motion by moving stud A upwards in its adjustments slot. To do so, loosen nut B.
3. To increase the lengthwise motion move stud C downwards in its adjustment slot. Here, a 17-mm, flat-ground openended spanner is needed.
4. To decrease the lengthwise motion move stud C upwards in its slot. A flat-ground, 17-mm openended spanner is required here, too.
5. Lateral positioning of the work clamp over the needle hole: turn eccentric ball stud D. First, loosen retaining screw E and tighten it securely after adjustment.
6. Lengthwise positioning of the work clamp over the needle hole: turn the eccentric stud of slot piece C (with the 17-mm openended spanner and a screwdriver).
7. Adjusting the clearance between sewing hook tip and needle: loosen nut G and turn eccentric stud F.

For older machines please see service manual for Pfaff 3334, Par. 1.4.

