

SINGER
152W2

LIST OF PARTS



MACHINE No. 152w2

INDEX

	Page
Accessories	13
Bobbin Winder	13
Feed Dogs	14
Knee Lifter	14
Machine No. 152w2	5
Numerical List of Parts	17
Throat Plates	15

INSTRUCTIONS FOR ORDERING

In ordering from this list, use **ONLY** the PART number in the **FIRST** column.

The number stamped on a Sewing Machine Part is the number of the Single Part only, except when the part includes Set Screws, Clamping Screws, Studs and Rollers Spun on, Small Wires riveted, or Parts soldered together, etc., which it is necessary to furnish in combination.

Every combination of parts sent out has its specific number which, although not stamped on Parts (except in above case), must be used when ordering the combination.

Each number always indicates the **SAME PART** in whatever list it appears, or for whatever Machine.

The letters after some of the numbers indicate the style of finish only, as follows:

- A. Hardened, Polished and Plated.
- B. Polished and Plated.
- C. Hardened only.
- D. Polished only.
- E. Soft, not polished.
- F. Hardened and Polished.
- H. Blued.
- J. Nickel Plated only.
- R. Merlized.
- Y. Black Nickel Plated only.

These letters **MUST BE USED** when they appear in the list and **AFTER** the number, as in the list.

In this series

200001 to 201500 and 350001 to 351500 are Screw Numbers.
 201501 to 201800 and 351501 to 351800 are Nut Numbers.
 201801 to 202000 and 351801 to 352000 are Roller Numbers.
 202001 to 350000 are Numbers of Machine Parts.

The figures in the second column refer only to the plate in which the illustration of the part is shown and are **NOT TO BE USED** in ordering.

Two or more numbers over a cut indicate that the difference between such parts is not visible in an illustration.

Parts marked with an asterisk (*) are furnished only when repairs are made at the factory.

LIST OF PARTS COMPLETE FOR

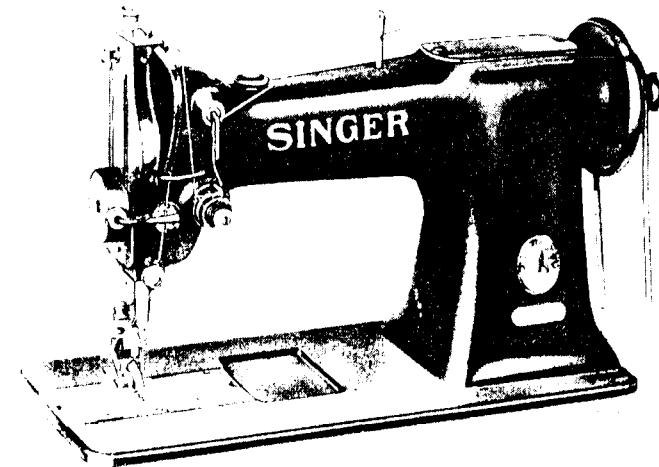

MACHINE No. 152w2

**HIGH SPEED. SINGLE NEEDLE. DROP FEED.
 VERTICAL HOOK. BELT DRIVE. LINK TAKE-UP.
 BALL BEARING ROLLER PRESSER. KNEE LIFTER.**

For General Leather Work.

No.	Plate	Name
*265501	-----	Arm with 202135
265502	16704	" Cap
200278H	16701	" " Screw
202248	16701	" " " Washer
204235	16701	" Position Pin (2)
200010E	16701	" Screw (3)
202005	16701	" " Washer (3)
202249	16704	" Shaft with 200357E and 224392
240802	16704	" " Bushing (back) with 202244
202244	-----	" " " " Oil Packing (wick)
207080	16704	" " " (front) with 202244
202244	-----	" " " " Oil Packing (wick)
200502B	16701	" " " " " Thumb Screw
200342C	16701	" " " " Set Screw (2)
265503	16704	" " Connection Belt
265504	16703	" " " " Pulley with 200603E, 201346C and two 214206
200603E	16701	Arm Shaft Connection Belt Pulley Position Screw

No.	Plate	Name
201346C	16701	Arm Shaft Connection Belt Pulley Set Screw
214206	16701	Arm Shaft Connection Belt Pulley Spring Flange
265542	16701	Arm Shaft Connection Belt Timing Collar with 200113F
200113F	16701	Arm Shaft Connection Belt Timing Collar Set Screw
265505	16701	Arm Shaft Connection Belt Timing Plate
200164B	16701	" " " " " " " " Screw (2)
224392	-----	Arm Shaft Oil Packing (wick)
200357E	16701	" " " " Stop Screw
244063	16704	Balance Wheel (disc) (belt groove 2-1/8 in.diam.) with 200328C and 200335C
200328C	16701	Balance Wheel Position Screw
200335C	16701	" " Set Screw
*265506	-----	Bed with 54897
54897	16701	" Oil Cup
265507	16703	" Slide (front)
240003	16703	" " (back)
223811	16701	" " " Stop
223812	16707	" " " Spring
203208	16702	Bobbin
241873	16702	" Case Base with 202056, 203211 to 203213 and 203216
203211	16702	Bobbin Case Base Latch
*202056	-----	" " " " Pin
203212	16702	" " " " Plunger
203213	16702	" " " " Spring
237168	16702	" " Cap with 200594C, 200984C, 203214, 241674, 241675 and two 350405C
241674	-----	Bobbin Case Oiling Felt
241675	16702	" " " " Retainer
350405C	16702	" " " " " Screw
224004	16702	" " Opener
224005	16702	" " Lever with 201349C, 201542C and 203101
201349C	16702	Bobbin Case Opener Lever Driving Screw Stud
201542C	16702	Bobbin Case Opener Lever Driving Screw Stud Nut
203101	-----	Bobbin Case Opener Lever Driving Screw Stud Oil Packing (wick)
223622	16702	Bobbin Case Opener Lever Hinge Stud with 202277
202277	-----	Bobbin Case Opener Lever Hinge Stud Oil Packing (wick)
200364C	16702	Bobbin Case Opener Lever Hinge Stud Set Screw
223623	16702	Bobbin Case Opener Lever Link

No.	Plate	Name
200118D	16702	Bobbin Case Opener Screw
203214	16702	" " Tension Spring
200984C	16702	" " " " Regulating Screw
200894C	16702	" " " " Screw
203214	-----	" " Washer (cloth)
241876	-----	Bobbin Case complete, Nos. 237168 and 241873
265508	16704	Face Plate and Oil Reservoir
202135	16702	" " Position Pin
200462B	16702	" " Thumb Screw
265532	-----	Face Plate and Thread Lubricator complete, Nos. 240439, 241755, 241759, 250930X, 265508 and 265530
265509	16703	Feed Bar
200641C	16702	" " Hinge Screw (driving)
201522E	16702	" " " " Nut
211764	16710	" Dog
200106E	16702	" " Screw (?)
202297	16704	" Driving Connection with 200054E and 202277
202298	16705	Feed Driving Connection Crank with 200038C
200038C	16705	Feed Driving Connection Crank Pinch Screw
200545C	16705	Feed Driving Connection Hinge Screw
201518E	16705	" " " " " Nut
202277	-----	" " " Oil Packing (wick)
200054E	16705	" " " Pinch Screw
265515	16703	" " Eccentric Regulating Bracket
265516	-----	" " " " " " 265515 with 265504, two each 201014C and 201525E
201014C	16705	Feed Driving Eccentric Regulating Bracket Hinge Screw
201525E	16705	Feed Driving Eccentric Regulating Bracket Hinge Screw Nut
202301	16705	Feed Driving Eccentric Regulating Bracket Plunger
202595	16705	Feed Driving Eccentric Regulating Bracket Plunger Spring
200607C	16705	Feed Driving Eccentric Regulating Bracket Plunger Spring Stop Screw
201014C	16705	Feed Driving Eccentric Regulating Bracket Stop Screw
201525E	16705	Feed Driving Eccentric Regulating Bracket Stop Screw Nut
200429C	16705	Feed Driving Eccentric Regulating Screw
200383C	16705	Feed Driving Eccentric Regulating Screw Check Screw
202303	16704	Feed Driving Rock Shaft

PARTS FOR MACHINE No. 152w2

No.	Plate	Name
265517	-----	Feed Driving Rock Shaft 202303 with 200641C, 201058C, 201522E, 224052, 225837 and 265509
202305	16705	Feed Driving Rock Shaft Center (2)
200043C	16705	" " " " " Set Screw (2)
224154	16705	" Lifting Eccentric with 201220C
224052	16705	" " " Fork with 200173D and 223655
201058C	16705	Feed Lifting Eccentric Fork Screw
225837	16705	" " " " " Washer
223655	-----	" " " Oiling Felt
200173D	16705	" " " " " Screw
201220C	16705	" " " Position Screw
202310	16703	" Regulating Spindle with 202311, 202443 and 202619
*202311	-----	Feed Regulating Spindle Head
202443	16705	" " " " " Pin
202619	16705	" " " " " Position Pin
*224016	-----	Hook (sewing)
224115	16706	" with 224025, 224100, two each 200590H and 201253F
265545	-----	Hook and Bobbin Case complete, Nos. 224115 and 241876
224019	16706	Hook Bushing (lower) (bronze)
265520	16706	" " (upper) (bronze)
200446C	16706	" " Position Screw
200364C	16702	" " (lower) Set Screw
265521	16703	" Driving Gear (spiral) with 200362C and 201222C
201222C	16706	Hook Driving Gear Position Screw
200362C	16708	" " " Set Screw
265522	16706	" " Pinton (spiral) with two 200382C
200382C	16706	Hook Driving Pinton Set Screw
224022	16706	" " " Thrust Washer (lower)
265523	16706	" " " " " (upper)
265524	16704	" " Shaft
224111	16703	" " " Bushing (back) with 202244
202244	-----	Hook Driving Shaft Bushing (back) Oil Packing (wick)
200327C	16706	Hook Driving Shaft Bushing (back) Set Screw
237529	16703	Hook Driving Shaft Bushing (front)
202244	-----	" " " " " Oil Packing (wick)
200327C	16706	Hook Driving Shaft Bushing (front) Set Screw

PARTS FOR MACHINE No. 152w2

No.	Plate	Name
265541	16703	Hook Driving Shaft Connection Belt Pulley with 201254C, 201421C and 214206
201254C	16706	Hook Driving Shaft Connection Belt Pulley Position Screw
201421C	16706	Hook Driving Shaft Connection Belt Pulley Set Screw
214206	16701	Hook Driving Shaft Connection Belt Pulley Spring Flange
224100	16706	Hook Gib
201253F	16706	" " Screw
223849	-----	" Saddle with 200009E
265525	16704	" " 223849 with 200364C, 200446C 224019 and 265520
223681	16703	Hook Saddle Bearing
200335C	16701	" " " Set Screw
200009E	16706	" " Pinch Screw
200009E	16706	" " Screw
225595	16706	" " " Washer
265526	-----	Hook Saddle complete, Nos. 200118D, 200364C, 223622, 223623, 224004, 224005 224022, 265522, 265523, 265525 and 265545
224025	16706	Hook Washer
200590H	16706	" " Screw
237837	16704	Knee Lifter Connection Lever
244035	-----	" " " " 237837 with 202447, 244034 and two 200262H
200262H	16706	Knee Lifter Connection Lever Hinge Screw
202447	16704	" " " " Lifting Rod with 202302
202302	16706	Knee Lifter Connection Lever Lifting Rod Cotter Pin
244034	16704	Knee Lifter Lifting Lever
200262H	16706	" " " " Hinge Screw
265527	16707	Needle Bar with 200141F
263117	16707	" " Bushing
265528	-----	" " " 263117 with 265527
200352C	16706	" " " Set Screw
202331	16707	" " Connecting Link
264718	16707	" " " " Oil Guard
200161D	16701	" " " " " " Screw
202333	16707	" " " " Stud with 202254
202254	-----	Needle Bar Connecting Link Stud Oil Packing (wick)
200374C	16707	Needle Bar Connecting Link Stud Set Screw
*206891	-----	Needle Bar Connecting Stud

PARTS FOR MACHINE No. 152w2

No.	Plate	Name
202329	16707	Needle Bar Connecting Stud 206891 with 200086C and 202330
202330	-----	Needle Bar Connecting Stud Oil Packing (wick)
200086C	16707	Needle Bar Connecting Stud Pinch Screw
202328	16703	" " Crank with 200335C, 200428C, 202333 and two 200374C
265529	-----	Needle Bar Crank 202328 with 202329, 202331, 202399, 202400 and 240139
203172	16707	Needle Bar Crank Friction Washer
200428C	16707	" " " Position Screw
200335C	16701	" " " Set Screw
200141F	16707	" Set Screw
207072	10249	Presser Bar Bushing
200398C	16707	" " " Set Screw
202339	10249	" " Lifter
200653C	10249	" " Hinge Screw
244004	10249	" " Lifting Releasing Lever Bracket
200260D	10249	Presser Bar Lifting Releasing Lever Bracket Guide Screw
206608	10249	Presser Bar Lifting Releasing Lever Bracket Spring
202337	10249	Presser Bar Position Guide
202338	16707	" " " " Lever with 200086F
200086F	16707	Presser Bar Position Guide Lever Pinch Screw
200352C	16706	Presser Bar Position Guide Set Screw
263098	16708	" " Spring
202346	10249	" " Stop Rod
24933	16707	" " Stop Collar with 175D
175D	16707	" " " " Pinch Screw
200492B	10249	" " Thumb Screw (pressure regulating)
200475B	16707	Presser Bar Thumb Screw Thumb Set Screw
202355	16707	Presser Bar Thumb Screw Thumb Set Screw Packing (brass)
351846	16708	Roller Presser, 13/16 in. diam. 5/32 in. face (extra fine) with 1528J, 201699C 350104C and twenty-eight 206417
203422	16708	Roller Presser Arm
249080	16708	" " " 203422 with 351846
233807	16708	" " " Bracket
235088	16708	" " " " Position Collar with 200362C
200117F	16708	Roller Presser Arm Bracket Position Collar Position Screw

PARTS FOR MACHINE No. 152w2

No.	Plate	Name
200362C	16708	Roller Presser Arm Bracket Position Collar Set Screw
202558	16708	Roller Presser Arm Bracket Spring
202559	16708	" " " " " Stop
200141F	16707	" " " " " Screw
200096D	16708	" " " Screw
206417	16708	" " Ball, 1/16 in. diameter
201699C	16708	" " " Cone
202557	16703	" " Bar
265543	-----	Roller Presser and Bar complete, Nos. 200096D, 200117F, 202557 to 202559, 233807, 235088, 249080 and two 200141F
350104C	16708	Roller Presser Hinge Screw
1528J	16708	" " " " Nut
240139	16709	Take-up Lever
202399	16708	" " Driving Stud with 202277
202277	-----	" " " " Oil Packing (wick)
202400	16708	Take-up Lever Hinge Stud with 202423
202423	-----	" " " " Oil Packing (wick)
200383C	16705	Take-up Lever Hinge Stud Set Screw
202401	-----	" " Oiling Felt
200132E	16708	" " " " Screw
244048	16709	Tension Disc (back)
244049	16709	" " (front)
202404	16709	" Release Plunger
202405	16709	" " Washer
202407	10881	" Spring
263106	16709	" " Washer
200625F	16709	" Stud with 204925
200061C	16709	" " Set Screw
204925	16709	" " Washer
201572B	10881	" Thumb Nut
263107	-----	Tension complete, Nos. 200625F, 201572B, 202405, 202407, 202410, 244048, 244049 and 263106
247606	16709	Thread Check Bracket
247607	16709	" " Cap
9543	16709	" " Disc
200154F	16709	" " Screw
247619	16709	" " Spring
247608	-----	Thread Check complete, Nos. 200154F, 247606, 247607, 247619 and two 9543
202410	16709	Thread Controller Spring
202411	16709	" " " Stop
200132E	16708	" " " " Screw
202412	16709	" Guide
202414	16709	" " "
263118	16709	" " (On needle bar bushing)

No.	Plate	Name
200389C	16709	Thread Guide Set Screw
241755	-----	" Lubricator Oil Pad (felt)
265530	16710	" " " " Holder
250930X	16710	" " " " " Pinch Collar with 237H
237H	16710	Thread Lubricator Oil Pad Holder Pinch Collar Screw
240439	16710	Thread Lubricator Oil Pad Retainer
241759	-----	" " " Wick
240034	16709	" Retainer
200366H	16709	" " Set Screw
265551	16710	Throat Plate, 53 needle hole, for needle sizes 12 and 13
200577XC	16710	Throat Plate Screw (2)

**Genuine Singer Needles should be used
in Singer Machines.
These Needles and their Containers
are marked with the
Company's Trade Mark "SIMANCO." 1**

**Needles in Containers marked
"For Singer Machines"
are not Singer made needles. 2**

ACCESSORIES

No.	Plate	Name
200460B	16710	Attachment Screw
203208	16702	Bobbin (5)
*225482	-----	" Case Screw Driver Blade
*225483	-----	" " " " Handle
225497	14334	Bobbin Case Screw Driver complete, Nos. 225482 and 225483
228212	-----	Drip Pan
16 x 246	-----	Needles, two each sizes 11, 12 and 13
12361	14334	Machine Hinge Connection (2)
41400	14334	" Rest Pin
120342	14334	Oiler (copper plated) with 120343
120343	14334	" Spout, 3-1/2 in. long
*225484	-----	Screw Driver Blade
*225485	-----	" " Handle
225498	14334	Screw Driver complete (7-1/4 in. long) Nos. 225484 and 225485
225554	14334	Wrench (steel)

BOBBIN WINDER

(SWINGING AUTOMATIC, RIGHT HAND)

225453	10884	Frame with 202277 and 225438
225454	10884	" Hinge Pin
202277	-----	" Oil Packing (wick)
225438	10884	" " Well Cap
225455	10884	" Spring
225456	10884	" " Plunger
202473	10885	Pulley with 200380C
200380C	10884	" Set Screw
225381	10884	Spindle
225444	10884	Stop Latch
200056E	10884	" " Screw
225458	10884	" " Thumb Lever
225459	10884	" " " " Hinge Stud
225459	10884	" " " " Joint Stud
202478	10884	" " Trip Lever
200299H	10884	" " " " Hinge Screw
225461	10881	Tension Bracket with 201499B
200082D	10881	" " Screw
228026	10884	" " " Washer
2102	10881	" Disc
202407	10881	" Spring

ACCESSORIES

No.	Plate	Name
201499B	10881	Tension Stud
201572B	10881	" " Thumb Nut
225462	10881	Bobbin Winder Tension Bracket complete, Nos.201572B,202407,225461 and two 2102
225433	10885	Bobbin Winder and Tension Bracket Base
225382	10885	Universal Bobbin Winder complete, Nos. 200056E, 200082D, 200299H, 202473, 202478, 225381, 225433, 225444, 225453 to 225456, 225458, 225462, 228026, two each 225459 and wood screws 3/4 in., No.12, R. H. B.

KNEE LIFTER

228294	15911	Rock Lever with two 356C
228295	15911	" " Bracket with 356C and four wood screws 7/8 in., No.12
228299	-----	Rock Lever Bracket 228295 with 228294 and 228297
228296	15911	Rock Lever Extension with 200529C
356C	15911	" " " " Set Screw
228297	15911	" " Hinge Pin
356C	15911	" " " " Set Screw
228284	15911	" " Knee Plate with 356C
202455	15911	" " " " Arm
356C	15911	" " " " Set Screw
356C	15911	" " " " Set Screw
227728	15911	" " Rod with 227729
*227729	-----	" " " " Cap
200529C	15911	" " " " Set Screw
228298	15911	Knee Lifter complete, Nos. 202455, 227728, 228284, 228296 and 228299

(Other Knee Lifter Parts are listed with parts
of machine head)

FEED DOGS

211264	16710	Feed Dog, for 265551
265510	16710	" " " 265533

THROAT PLATES

No.	Plate	Name
265551	16710	Throat Plate, 53 needle hole, for needle sizes 12 and 13, for 211264
265533	16710	Throat Plate, 56 needle hole, for needle sizes 10 and 11, for 265510

Genuine Singer Needles should be used
in Singer Machines.
These Needles and their Containers
are marked with the
Company's Trade Mark "SIMANCO."

Needles in Containers marked
"For Singer Machines"
are not Singer made needles.

PLATE 10249 FULL SIZE

Genuine Singer Needles should be used
in Singer Machines.
These Needles and their Containers
are marked with the
Company's Trade Mark "SIMANCO." 1

Needles in Containers marked
"For Singer Machines"
are not Singer made needles. 2

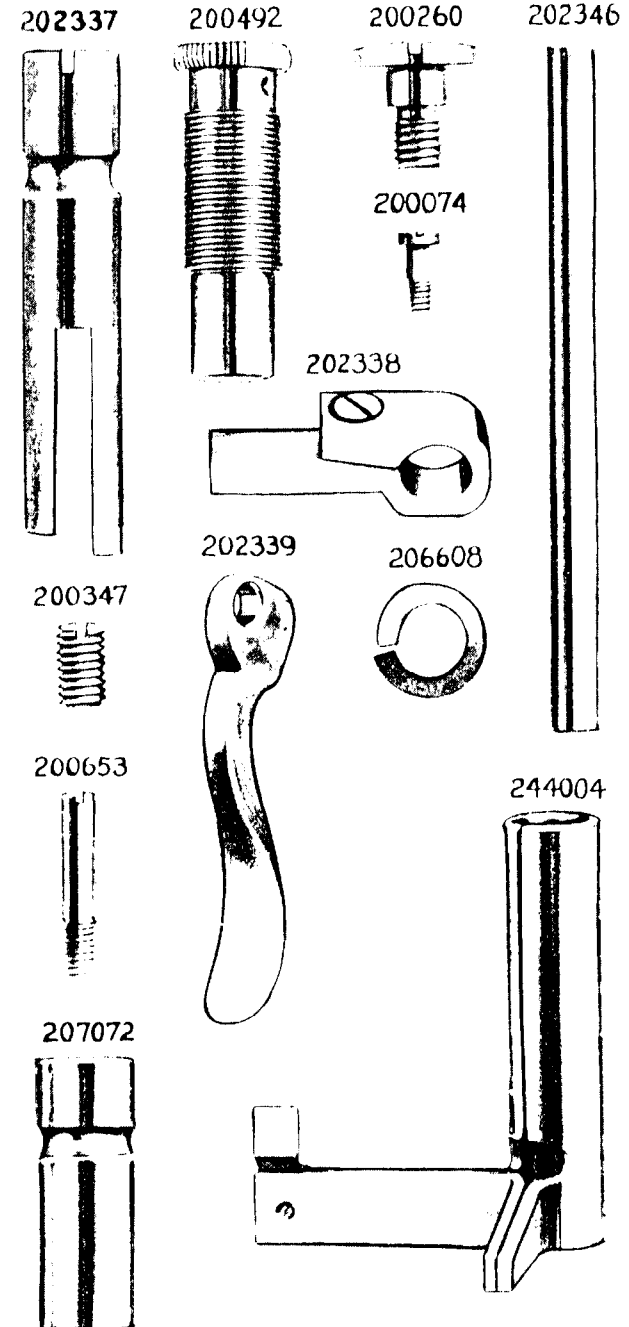
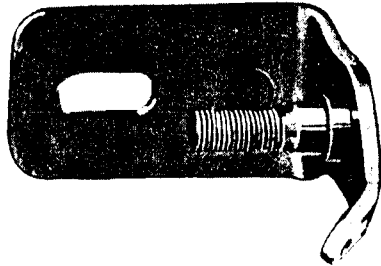
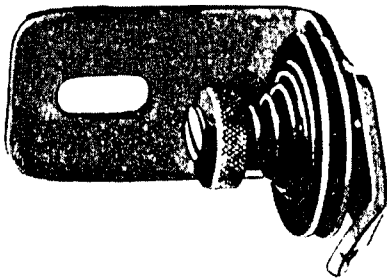

PLATE 10881—FULL SIZE

225461



225462



200082



202104



2102



202407



201499



201572



PLATE 10884 FULL SIZE

225473

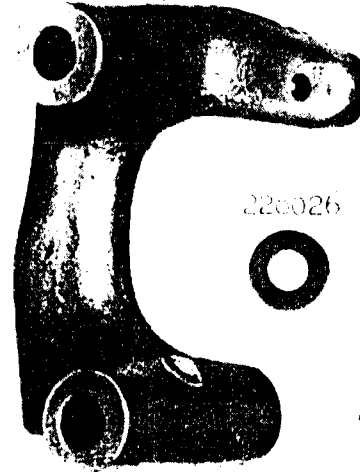

225474



202178



225026



225494



225495



225475



225475

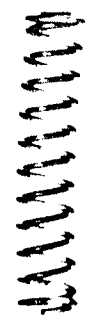

225477



225450



200299



200380



200056



225381

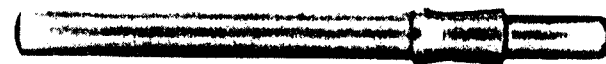
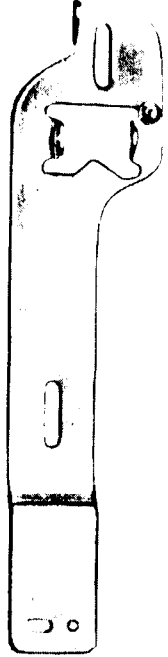

PLATE 10885 - ONE-FOURTH SIZE

225433



202475



225492

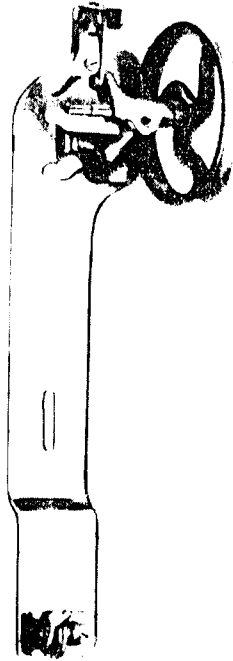
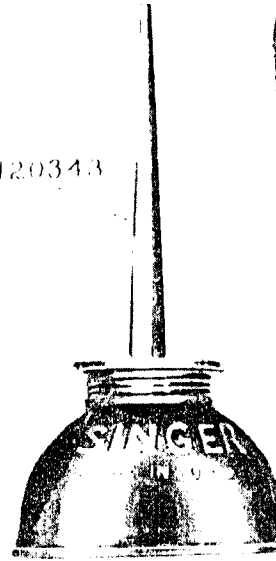

PLATE 14334 - ONE-HALF SIZE

120342



120343

225498

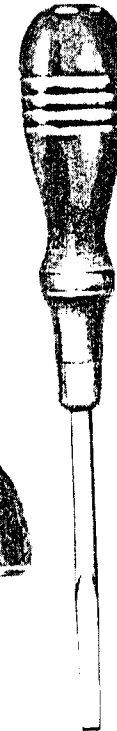

225497



225554



41400



12361



PLATE 15911-ONE-FOURTH SIZE

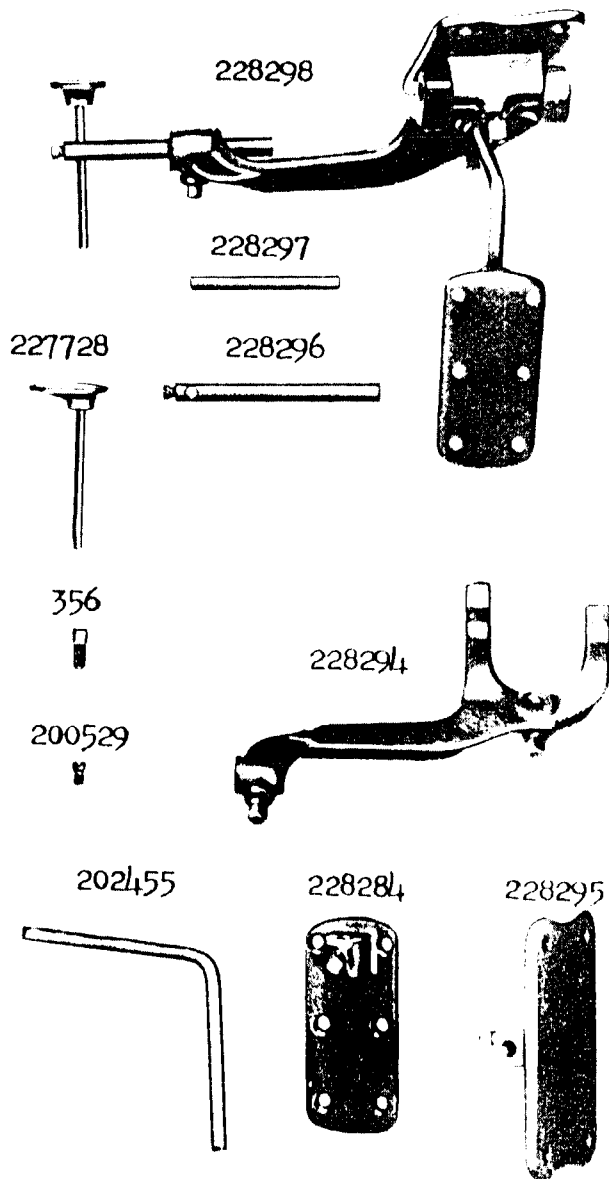

PLATE 16701 - FULL SIZE

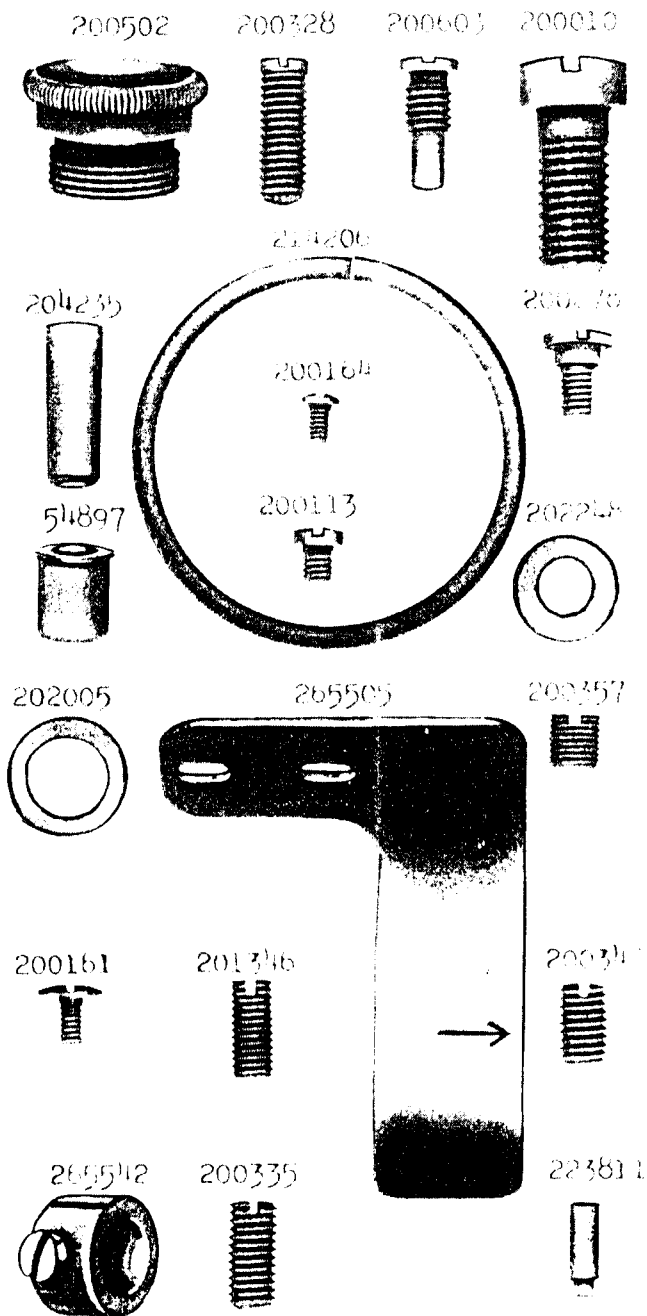

PLATE 16702 - FULL SIZE

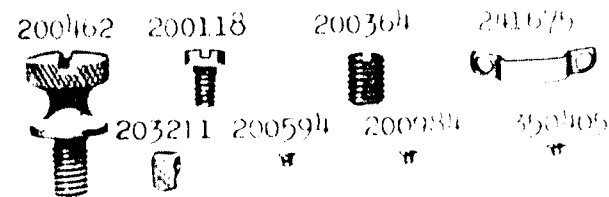
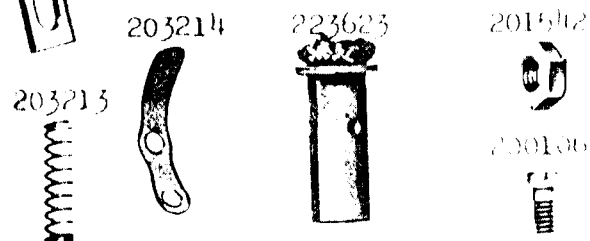
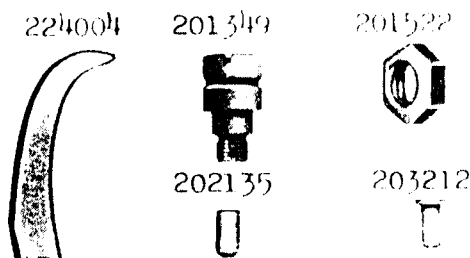
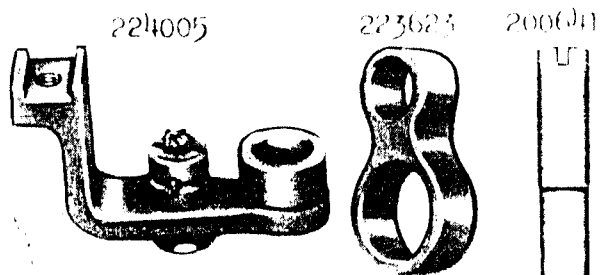
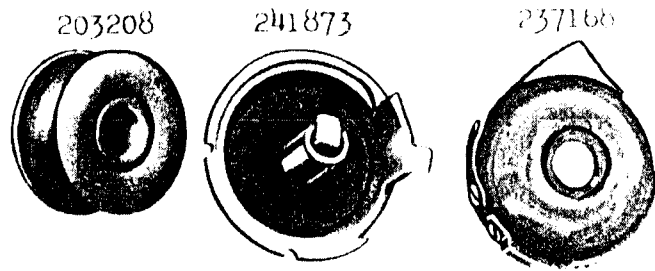

PLATE 16703 - ONE-HALF SIZE

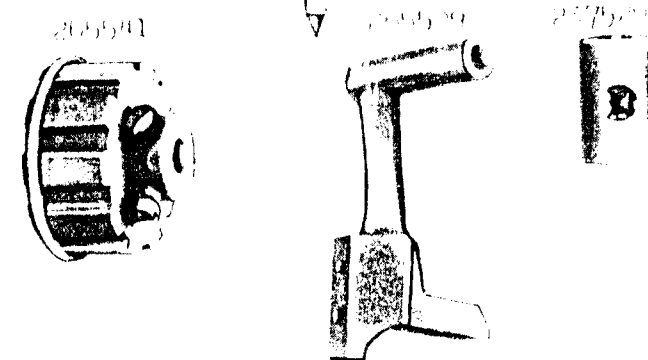
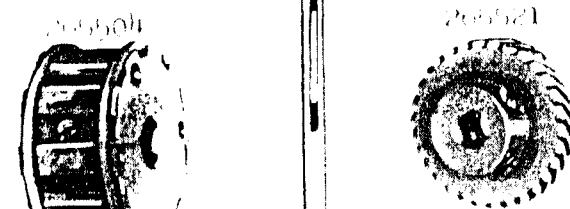
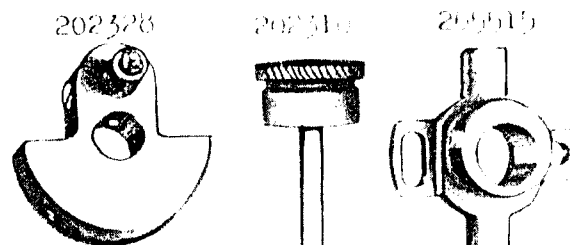
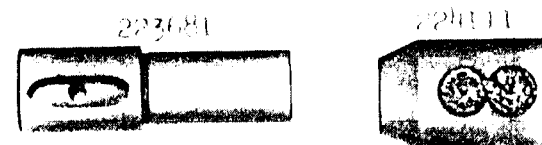
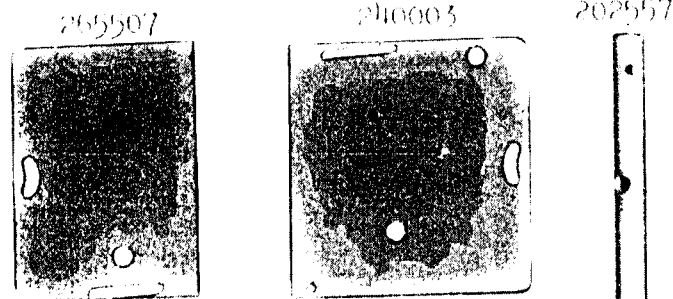

PLATE 16704 - ONE-FOURTH SIZE

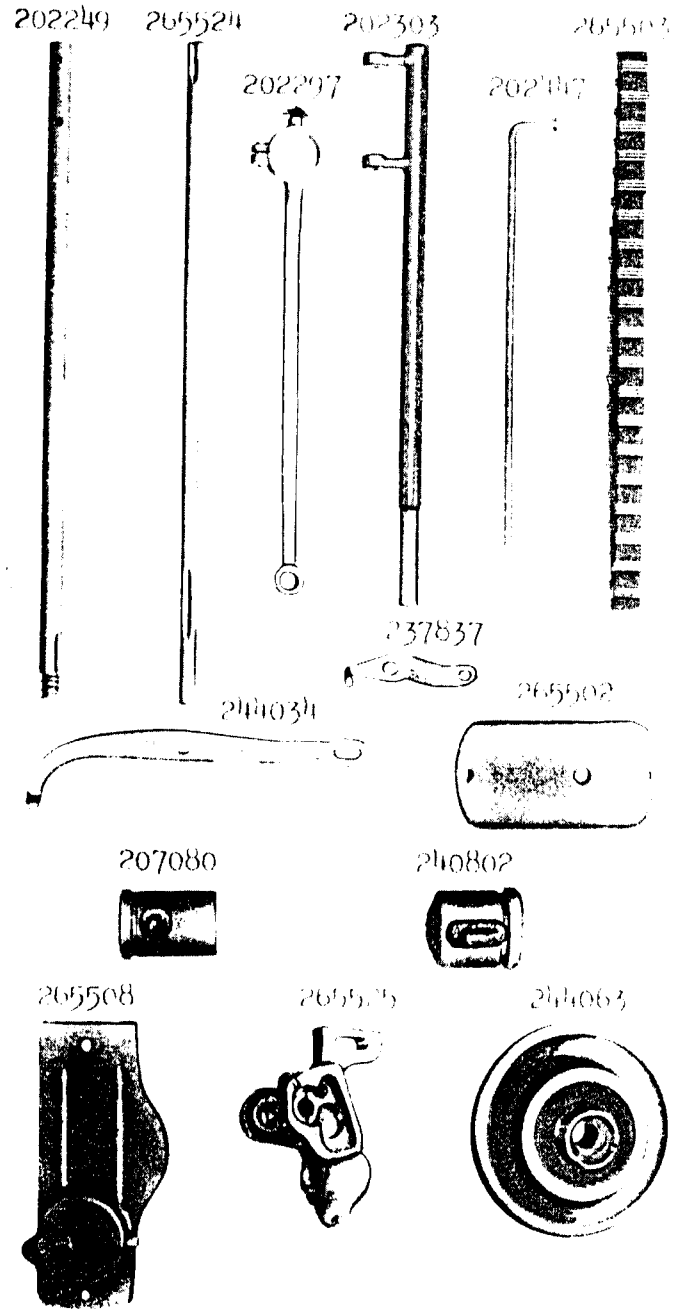

PLATE 16705 - FULL SIZE

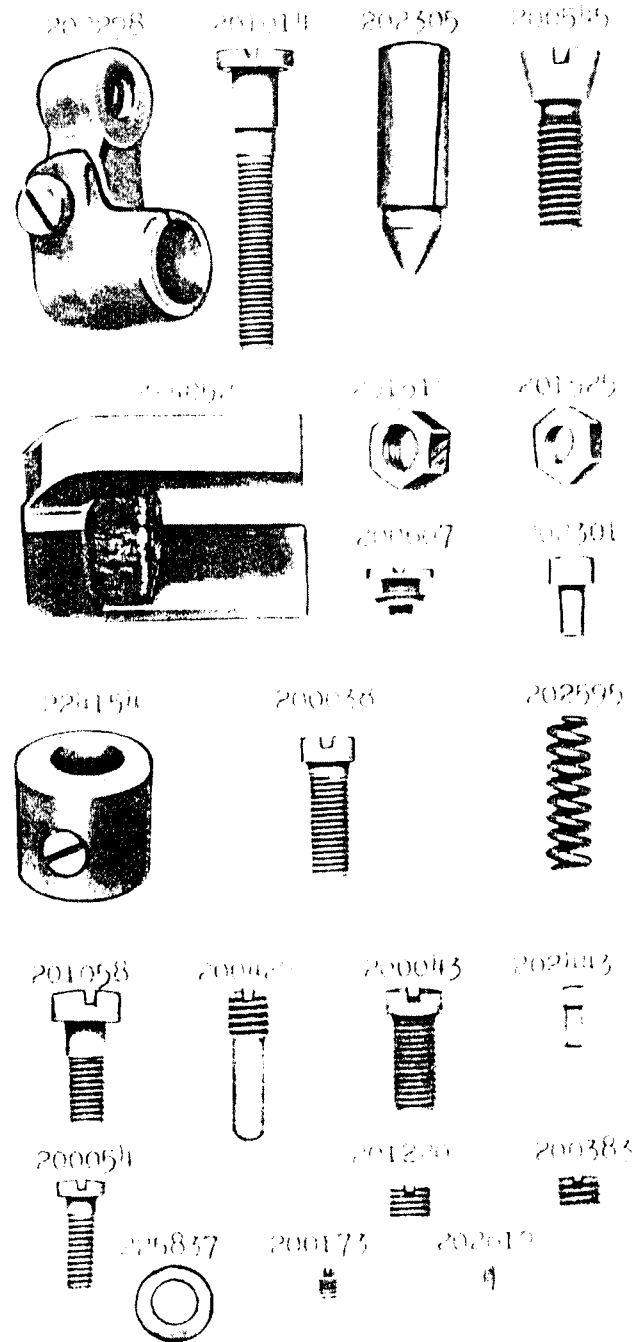

PLATE 16708 - FULL SIZE

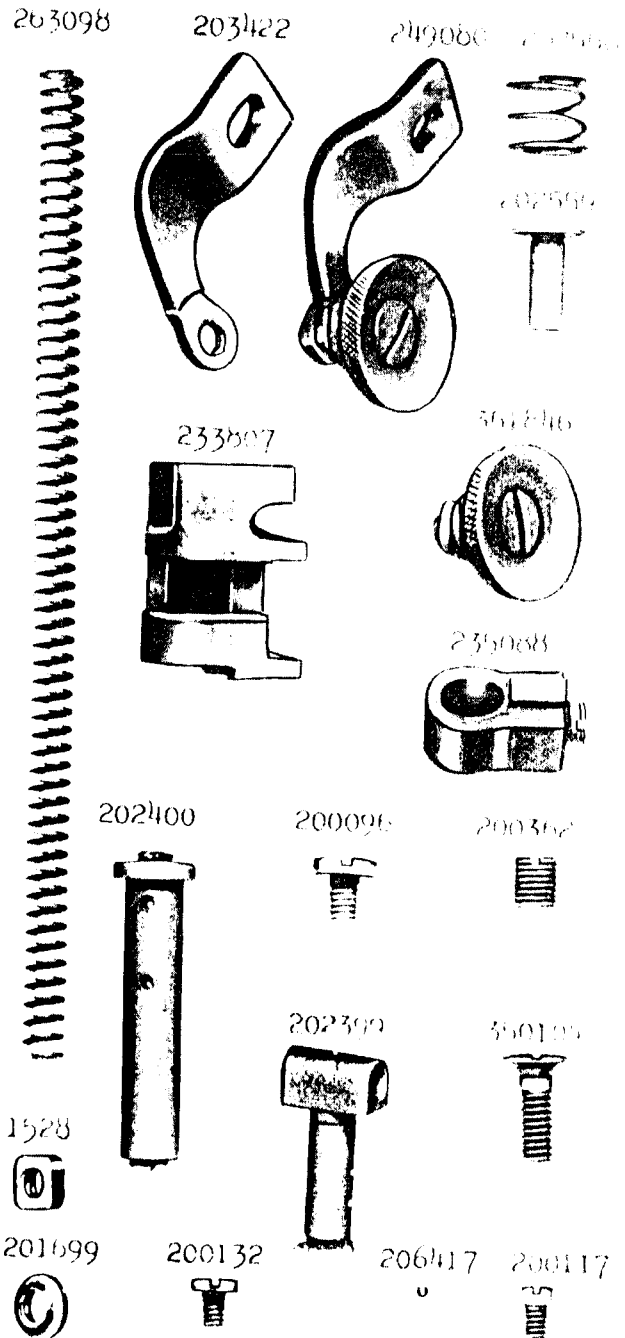

PLATE 16709 - FULL SIZE

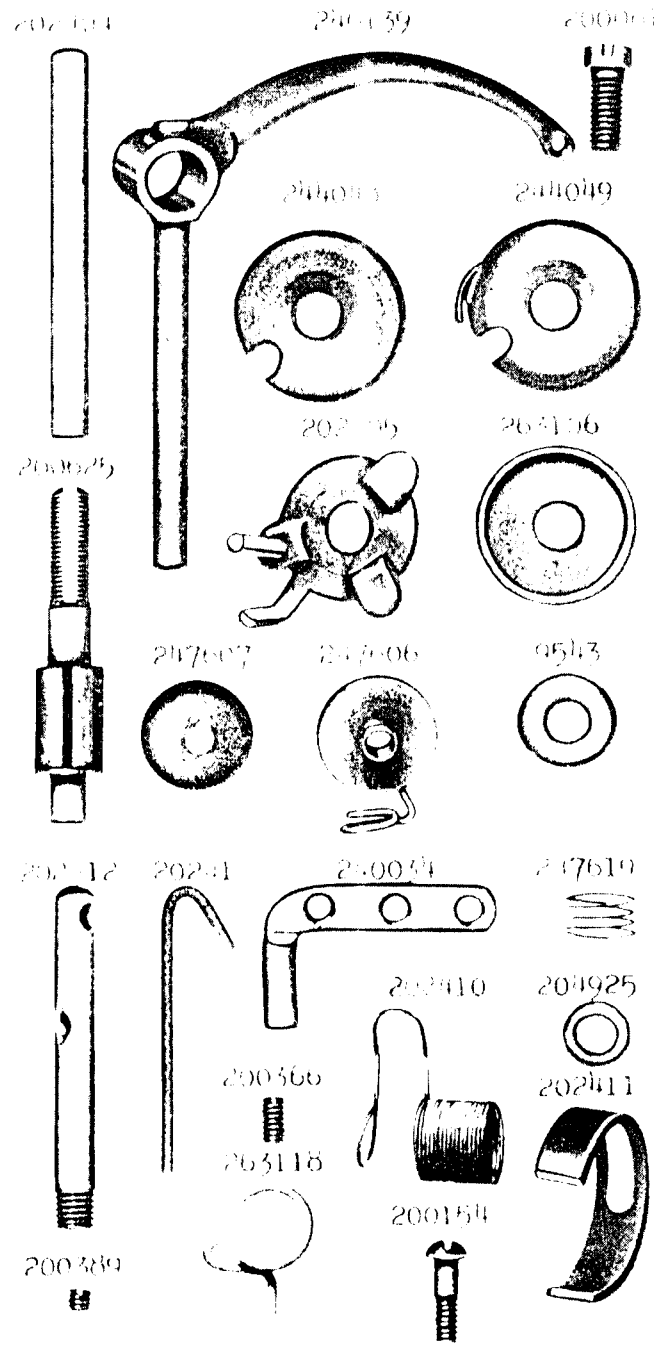
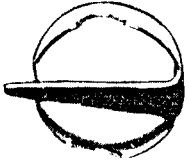
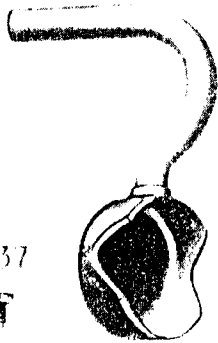

PLATE 16710 - FULL SIZE

240439



265530



200460

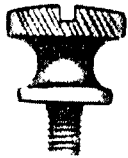

200577



237



250130



265551

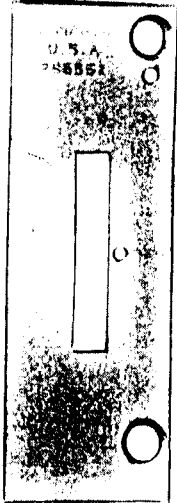

265533

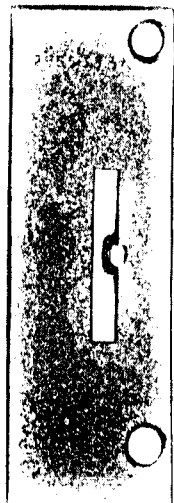

211264



265510

