

SINGER
157-1 & 157-2

LIST OF PARTS



SINGER** MACHINES Nos. 157-1 and 157-2

THE SINGER MANUFACTURING COMPANY

INSTRUCTIONS FOR OILING

Before starting the machine, it must be serviced, as instructed in Form 18666.

Each machine is equipped with an oil reservoir from which all the principal bearings receive a constant supply of oil, the oil flowing from the reservoir through the tubes.

Fill the oil reservoir level full of oil. This oil level should be maintained.

Excess oil drains into the machine base and may be drawn off through a petcock provided for the purpose.

To insure easy running and prevent unnecessary wear of the parts which are in movable contact, the machine requires oiling, and when in continuous use, "TYPE B" or "TYPE D" OIL, sold by Singer Sewing Machine Company, should be applied at least twice each day to all oil holes marked "OIL".

"TYPE D" OIL should be used when an oil is desired which will produce a minimum of stain on fabrics, even after a long period of storage.

INDEX

	PAGE
ACCESSORIES.....	35
FITTINGS FOR 157-1 MACHINE.....	32
5 FOOT LIFTER PARTS.....	36
KNEE LIFTER PARTS.....	37
MACHINE BASE OIL DRAIN JAR.....	36
MACHINE BASE.....	36
MACHINE NO. 157-1.....	7
" " 157-2.....	20
NUMERICAL LIST OF PARTS.....	39
THREAD UNWINDER.....	38
TIMING GAUGE.....	38

INSTRUCTIONS FOR ORDERING

In ordering from this list, use **ONLY** the part NUMBER in the **FIRST** column.

The number stamped on a Sewing Machine Part is in every case the number of the single part only.

Every combination of parts sent out as such has its specific number, which, although not stamped on the parts, must be used when ordering the combination.

Each number always indicates the **SAME PART** in whatever list it appears, or for whatever machine.

The letters after some of the numbers indicate the style of finish only, as follows:

- A—Hardened, Polished, Nickel Plated and Buffed
- B—Polished, Nickel Plated and Buffed
- C—Hardened Only
- D—Polished Only
- E—Soft, Not Polished
- F—Hardened and Polished
- H—Blued
- J—Nickel Plated Only
- K—Hardened and Nickel Plated
- L—Brass Plated
- M—Oxidized
- N—Japanned, Dull
- P—Japanned, Bright
- R—Merlized
- T—Copper Plated
- T. A.—Hardened, Polished, Copper and Nickel Plated and Buffed
- T. B.—Copper and Nickel Plated and Polished
- T. J.—Copper and Nickel Plated Only
- T. K.—Hardened, Copper and Nickel Plated
- T. M.—Copper Plated and Oxidized
- T. L.—Copper and Brass Plated
- U—Zinc Plated
- V.—Silver Plated
- W—Polished and Nickel Plated
- Y—Black Nickel Plated Only
- Z—Chromium Plated
- Z. B.—Polished, Nickel Plated, Buffed and Chromium Plated
- Z. J.—Nickel and Chromium Plated

These letters **MUST BE USED** when they appear in the list; and **AFTER** the number as in the list.

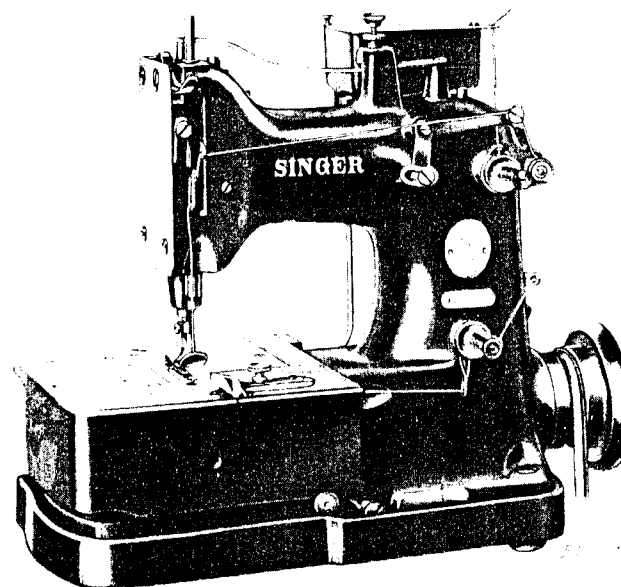
In this series:

- 1 to 1500, 50001 to 51500 and 140001 to 142000 are Screw Numbers
- 1501 to 1800 and 51501 to 51800 are Nut Numbers
- 1801 to 2000 and 51801 to 52000 are Roller Numbers
- 2001 to 50000 and 52001 to 190000 are Sewing Machine Parts, 190001 and upward are numbers of Electrical Parts.

The figures in the second column refer only to the plates, illustrating the parts, and are **NOT TO BE USED** in ordering.

Parts marked with an asterisk (*) are furnished only when repairs are made at factory.

LIST OF PARTS COMPLETE FOR



MACHINE No. 157-1

FOR STITCHING BAGS MADE FROM CLAY FILLED AND OTHER LIGHT MATERIAL SUCH AS IS USED FOR THE MANUFACTURE OF SALT, SUGAR, RICE AND FLOUR BAGS, ETC. MAKES $3\frac{1}{2}$ TO 8 STITCHES TO THE INCH. HAS ONE NEEDLE. LOOPER AND THROAT PLATE FOR TWO-THREAD CHAIN-STITCH; ALSO LOOPER AND THROAT PLATE FOR SINGLE THREAD CHAIN-STITCH. LIFT OF PRESSER FOOT $\frac{1}{8}$ INCH. WILL STITCH MATERIAL UP TO $\frac{1}{4}$ INCH IN THICKNESS. FITTED WITH OILING SYSTEM THAT AUTOMATICALLY LUBRICATES THE PRINCIPAL BEARINGS OF THE MACHINE.

NO.	PLATE	NAME
*130701	—	Arm, upper and lower (solid) with 15404 and two 15405

NO.	PLATE	NAME
130702	21719	Arm Back Cover
1095F	21707	" " " Screw
51333J	21702	" Oil Plug Screw
130703	21704	" " Tube with 54969, for oiling Needle Bar Connecting Link
130704	21704	Arm Oil Tube with 54969, for oiling Needle Bar Connecting Link Hinge Pin (lower)
130705	21704	Arm Oil Tube with 54969, for oiling Arm Rock Shaft Front Bearing
130706	21704	Arm Oil Tube with 54969, for oiling Arm Rock Shaft Back and Intermediate Bearings
54969	21714	Arm Oil Tube Oil Pad (braided cotton)
130707	21731	Arm Rock Shaft with 624c
130860	---	" " " 130707 with 130874
*130708	---	" " " Bushing (back)
130709	21728	" " " " " " 130708 with 130911
130911	21714	Arm Rock Shaft Bushing (back) Oil Pad (braided cotton)
443c	21703	Arm Rock Shaft Bushing (back) Set Screw
*130907	---	Arm Rock Shaft Bushing (intermediate)
130908	21728	Arm Rock Shaft Bushing (intermediate) 130907 with 130912
130912	21714	Arm Rock Shaft Bushing (intermediate) Oil Pad (braided cotton)
443c	21703	Arm Rock Shaft Bushing (intermediate) Set Screw
130876	21722	Arm Rock Shaft Crank (back, ball bearing solid) with 1177E
1177E	21701	Arm Rock Shaft Crank (back) Clamping Screw
40025	21704	Arm Rock Shaft Crank (back) Pin
*130909	---	" " " Flanged Bushing (front)
130910	21728	Arm Rock Shaft Flanged Bushing (front) 130909 with 130912
130912	21714	Arm Rock Shaft Flanged Bushing (front) Oil Pad (braided cotton)
443c	21703	Arm Rock Shaft Flanged Bushing (front) Set Screw

NO.	PLATE	NAME
130960	21737	Arm Rotary Shaft
130961	---	" " " 130960 with 691c and 130972
*130720	---	Arm Rotary Shaft Bushing (front)
130721	21728	" " " " " " 130720 with 130713
130713	21714	Arm Rotary Shaft Bushing (front) Oil Pad (braided cotton)
443c	21703	Arm Rotary Shaft Bushing (front) Set Screw
*130722	---	Arm Rotary Shaft Bushing (intermediate)
130723	21728	Arm Rotary Shaft Bushing (intermediate) 130722 with 130713
130713	21714	Arm Rotary Shaft Bushing (intermediate) Oil Pad (braided cotton)
448c	21703	Arm Rotary Shaft Bushing (intermediate) Set Screw
130896	21735	Arm Rotary Shaft Counterbalance with 130897, 130898 and two 896c
*130897	---	Arm Rotary Shaft Counterbalance Cap
896E	21703	Arm Rotary Shaft Counterbalance Cap Screw
130898	21704	Arm Rotary Shaft Counterbalance Position Pin
*130884	---	Arm Rotary Shaft Flanged Bushing (back)
130885	21734	Arm Rotary Shaft Flanged Bushing (back) 130884 with 57974
57974	21714	Arm Rotary Shaft Flanged Bushing (back) Oil Pad (braided cotton)
159F	21703	Arm Rotary Shaft Flanged Bushing (back) Screw
130962	---	Arm Rotary Shaft Oil Sling (back)
130972	21713	" " " " " " 130962 with 130963
130963	21704	Arm Rotary Shaft Oil Sling (back) Oil Tube
691c	21707	Arm Rotary Shaft Oil Sling (back) Screw
130730	---	Arm Rotary Shaft Oil Sling (front)
130973	21713	" " " " " " 130730 with 130731
130731	21704	Arm Rotary Shaft Oil Sling (front) Oil Tube

NO.	PLATE	NAME
130741	21718	Feed Lifting Eccentric with two 1036c
49253	21720	Feed Lifting Eccentric Connection with 457c, 2653, 55515 and two 896E
896E	21703	Feed Lifting Eccentric Connection Cap Screw
49030	21704	Feed Lifting Eccentric Connection Hinge Pin
457c	21707	Feed Lifting Eccentric Connection Hinge Pin Set Screw
55515	21714	Feed Lifting Eccentric Connection Oil Pad (braided cotton)
2653	21704	Feed Lifting Eccentric Connection Oil Pad Pin
1036c	21703	Feed Lifting Eccentric Set Screw
1103c	21707	" Regulating Screw
130893	21731	" Rocking Frame with 1396E
130894	---	" " " 130893 with 130746
11398	21727	Feed Rocking Frame Hinge Pin
*58293	---	" " " " "
		11398 with 1508E
1508E	21702	Feed Rocking Frame Hinge Pin Nut
622c	21702	Feed Rocking Frame Hinge Pin Screw Bushing
1508J	21702	Feed Rocking Frame Hinge Pin Screw Bushing Nut
130746	21714	Feed Rocking Frame Oil Pad (braided cotton)
27398	21704	Feed Rocking Frame Washer
120969	21710	Guide
194D	21707	" Screw Stud
671D	21701	" Thumb Screw
130921	21724	Looper, for single thread
130747	21724	" " double thread
		Note: Nos. 130747 and 130921 are sent with this machine.
130748	21731	Looper Bell Crank with 1147c, 130749 and 130939
46228	21724	Looper Bell Crank Ball Stud
1147c	21703	" " " " " Set Screw
130750	21727	Looper Bell Crank Connection with two 171E

NO.	PLATE	NAME
130872	---	Looper Bell Crank Connection 130750 with 46228
171E	21703	Looper Bell Crank Connection Cap Screw
130752	21720	Looper Bell Crank Connection Driver with two 1057E
1057E	21703	Looper Bell Crank Connection Driver Cap Screw
130754	21719	Looper Bell Crank Connection Hinge Screw Stud
1664J	21702	Looper Bell Crank Connection Hinge Screw Stud Nut
130755	21727	Looper Bell Crank Hinge Stud
435c	21703	" " " " " Set Screw (lower)
448c	21703	Looper Bell Crank Hinge Stud Set Screw (upper)
130749	21714	Looper Bell Crank Oil Pad (felt)
130939	21704	" " " " " Retainer
130756	21724	" Carrier with 130760 and three 1147c
130757	21722	Looper Carrier Connection with four 175E
130873	---	Looper Carrier Connection 130757 with 130956 and 130970
130970	21724	Looper Carrier Connection Ball Screw Stud (right)
1518J	21702	Looper Carrier Connection Ball Screw Stud (right) Nut
49043	21704	Looper Carrier Connection Ball Screw Stud (right) Washer (fibre)
130956	21724	Looper Carrier Connection Ball Stud (left)
1147c	21703	Looper Carrier Connection Ball Stud (left) Set Screw
49043	21704	Looper Carrier Connection Ball Stud (left) Washer (fibre)
175E	21703	Looper Carrier Connection Cap (left) Screw
175E	21703	Looper Carrier Connection Cap (right) Screw
130759	21724	Looper Carrier Hinge Stud
49166	21724	" " " " " Collar with two 202F
202F	21707	Looper Carrier Hinge Stud Collar Set Screw

NO.	PLATE	NAME
896E	21703	Looper Carrier Hinge Stud Set Screw
130760	21714	Looper Carrier Oil Pad (braided cotton)
130761	21721	Looper Carrier Rock Shaft
130762	21721	" " " " Crank (back) forked, with 51313c
51313c	21703	Looper Carrier Rock Shaft Crank (back) Position Screw
49049	21721	Looper Carrier Rock Shaft Crank (back) Slide Block
130763	21721	Looper Carrier Rock Shaft Crank (front) with 896E and two 157E
157E	21701	Looper Carrier Rock Shaft Crank (front) Clamping Screw
130764	21720	Looper and Thread (under) Take-up Eccentric with two 1036c
1036c	21703	Looper and Thread (under) Take-up Eccentric Set Screw
130765	21733	Looper Gate
63c	21701	" " Hinge Screw
2818	21704	" " " " Friction Washer
1147c	21703	Looper Set Screw
130766	21734	Needle Bar (hollow)
130767	21727	" " Bushing (lower)
435E	21703	" " " " Set Screw
130768	21727	Needle Bar Bushing (upper)
1133E	21707	" " " " Set Screw
130769	21716	Needle Bar Connecting Link
130874	—	" " " " 130769 with 49268 and 130771
*130770	—	Needle Bar Connecting Link Hinge Pin
130771	21724	Needle Bar Connection Link Hinge Pin 130770 with 130772
*130772	—	Needle Bar Connecting Link Hinge Pin Oil Tube
624c	21703	Needle Bar Connecting Link Hinge Pin Set Screw
49268	21727	Needle Bar Connecting Stud with 1454E
1454E	21703	Needle Bar Connecting Stud Clamping Screw

NO.	PLATE	NAME
130932	21714	Needle Bar Oil Pad (felt)
130940	21713	" " " " Retainer
316c	21703	" " " " " Screw
1629c	21702	" Clamping Nut
130773	21720	" Guard
162D	21701	" " Screw
130964	21734	Oil Reservoir
130965	21736	" " Cover
50116D	21707	" " " Hinge Screw
130953	21714	" " " " " Friction Washer
1127D	21707	Oil Reservoir Cover Thumb Screw
*130776	—	" " Oil Pipe for 130966
130966	21735	" " " " 130776 with 130784, for oiling Arm Rotary Shaft Back Bearing
*130784	—	Oil Reservoir Oil Pipe Joint for 130966
*130779	—	Oil Reservoir Oil Pipe for 130967
130967	21735	" " " " 130779 with 130778, for oiling Arm Rotary Shaft Intermediate Bearing
*130778	—	Oil Reservoir Oil Pipe Joint for 130967
*130782	—	Oil Reservoir Oil Pipe for 130783
130783	21735	" " " " 130782 with 130784, for oiling Looper Bell Crank Connection Driver
*130784	—	Oil Reservoir Oil Pipe Joint for 130783
*130785	—	Oil Reservoir Oil Pipe for 130968
130968	21735	" " " " 130785 with 130778, for oiling Arm Rotary Shaft Front Bearing
*130778	—	Oil Reservoir Oil Pipe Joint for 130968
130787	21710	Oil Reservoir Oil Pipe Clamping Plate
176J	21701	Oil Reservoir Oil Pipe Clamping Plate Screw
130788	21710	Oil Reservoir Oil Pipe Position Plate
130789	21710	Oil Reservoir Oil Tube for 130967 and 130968
130791	21710	Oil Reservoir Oil Tube for 130783 and 130966

NO.	PLATE	NAME
130957	21710	Oil Reservoir Oil Tube for oiling Crank Connecting Rod (upper) Bearing
130793	21730	Oil Reservoir Oil Tube Wick (9 strands) for 130783
130794	21730	Oil Reservoir Oil Tube Wick (6 strands) for 130967 and 130968
130795	21730	Oil Reservoir Oil Tube Wick (8 strands) for 130966
130797	21730	Oil Reservoir Oil Tube Wick (5 strands) for 130957
130969	—	Oil Reservoir complete, Nos. 1127D, 50116D, 130793, 130795, 130797, 130953, 130957, 130964, 130965 and two each 130789, 130791 and 130794
50152D	21701	Oil Reservoir Screw for 130969
130899	21710	" " for 130902
130900	21704	" " Oil Tube (brass)
130901	21719	" " Wick (wick)
130902	—	Oil Reservoir complete, for oiling Feed Connecting Rod, for 130734, Nos. 130899 to 130901
894F	21701	Oil Reservoir Screw for 130734 and 130902
130799	21734	Presser Bar
130800	21721	" " Bushing (lower)
435E	21703	" " " " Set Screw
49061	21727	Presser Bar Bushing (upper)
1133E	21707	" " " " Set Screw
49062	21723	Presser Bar Lifter
212D	21707	" " " Cap Screw
49063	21704	" " " Friction Washer
49064	21723	" " " Hinge Stud
453C	21703	" " " " " Set Screw
130801	9440	Presser Bar Lifting Bracket with 453C and 892F
892F	21702	Presser Bar Lifting Bracket Adjusting Screw
453C	21703	Presser Bar Lifting Bracket Set Screw

NO.	PLATE	NAME
49066	21723	Presser Bar Lifting Link
212D	21707	" " " " Cap Screw
724C	21707	" " " " Hinge Screw
49067	21734	Presser Bar Spring (flat)
38468	21716	" " " Stud
51242C	21703	" Foot Hinge Screw
130929	—	" " Plate
130847	—	" " Shank
130930	21712	Presser Foot (hinged) complete, to make three to four stitches to the inch, Nos. 51242C, 130847 and 130929
190J	21707	Presser Foot Screw
574W	21701	Pressure Regulating Thumb Screw
1539W	21702	" " " " Lock Nut
130959	21723	Slack Thread Controller
1095F	21707	" " " Screw
2102	21723	Tension (under thread) Disc
51570C	21702	" " " Regulating Thumb Nut
50326C	21701	Tension (under thread) Screw Stud
59539	—	" " " " " 50326C with 51570C
59534	9440	Tension (under thread) Spring
59537	21723	" " " " Bushing (large)
59538	9440	Tension (under thread) Spring Bushing (small)
32572	21723	Tension (under thread) Spring Washer
130807	9440	Tension (under thread) Thread Guide
50530K	21702	Tension (upper thread, automatic) Body
15770	21723	Tension (upper thread, automatic) Cap
130808	21723	Tension (upper thread, automatic) Releasing Cam with 1036C
1036C	21703	Tension (upper thread, automatic) Releasing Cam Set Screw
130809	21704	Tension (upper thread, automatic) Releasing Pin
9540	21724	Tension (upper thread, automatic) Spring

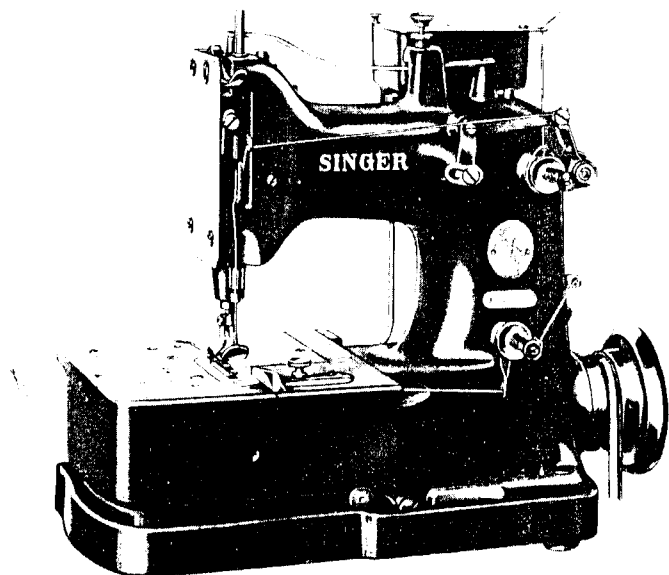
NO.	PLATE	NAME
848κ	21707	Tension (upper thread, automatic) Stud
9541	21704	Tension (upper thread, automatic) Stud Plug (micarda)
34527	—	Tension (upper thread, automatic) complete, Nos. 848κ, 9540, 9541, 15770 and 50530κ
130849	9440	Tension (upper thread, automatic) Thread Guide
190J	21707	Tension (upper thread, automatic) Thread Guide Screw
2102	21723	Tension (upper thread) Disc
51570c	21702	" " " " Regulating Thumb Nut
50326c	21701	Tension (upper thread) Screw Stud
59539	—	" " " " " " 50326c with 51570c
59534	9440	Tension (upper thread) Spring
59537	21723	" " " " Bushing (large)
59538	9440	Tension (upper thread) Spring Bushing (small)
32572	21723	Tension (upper thread) Spring Washer
49220	21705	Tension (upper thread) Thread Guide
130931	21705	Thread (under) Take-up for medium and heavy work
Note: No. 130931 is regularly furnished with this machine.		
130810	21705	Thread (under) Take-up for light and medium work
130862	21705	Thread (under) Take-up Connection (forked) with two 1057E
1057E	21703	Thread (under) Take-up Connection Cap Screw
130864	9440	Thread (under) Take-up Connection Slide Block
190J	21707	Thread (under) Take-up Screw
130811	9440	" " " " Thread Guide
175J	21703	" " " " " " Screw
130812	21723	Thread (under) Thread Guide (back of arm)

NO.	PLATE	NAME
1423J	21707	Thread (under) Thread Guide Screw
130813	21706	" (upper) Controller
1095F	21707	" " " " Adjusting Screw
691F	21707	Thread (upper) Controller Screw
130814	21723	" " " " Thread Guide
940c	21707	Thread (upper) Controller Thread Guide Screw
130815	21705	Thread (upper) Take-up with 1147c
1147c	21703	" " " " Set Screw
130926	21729	Throat Plate with 665J and 130928, for single thread, for 130919 and 130920
130928	21729	Throat Plate Thread Retainer for 130926
665J	21707	Throat Plate Thread Retainer Screw
130927	21729	Throat Plate for double thread, for 130919 and 130920
691F	21707	Throat Plate Screw
*15404	—	Trade Mark
15405	—	" " Rivet

SINGER Needles should be used
in SINGER Machines
These Needles and their Containers
are marked with the
Company's Trade Mark "SIMANCO.**" 1

Needles in Containers marked
"FOR SINGER MACHINES"
are NOT SINGER made needles. 2

LIST OF PARTS COMPLETE FOR



MACHINE No. 157-2

FOR STITCHING HEAVY BURLAP BAGS. MAKES 2 TO 4 STITCHES TO THE INCH. HAS ONE NEEDLE, LOOPER AND THROAT PLATE FOR TWO-THREAD CHAIN-STITCH, ALSO LOOPER AND THROAT PLATE FOR SINGLE THREAD CHAIN-STITCH. LIFT OF PRESSER FOOT $\frac{1}{16}$ INCH. WILL STITCH MATERIAL UP TO $\frac{3}{8}$ INCH IN THICKNESS. FITTED WITH AN OILING SYSTEM THAT AUTOMATICALLY LUBRICATES THE PRINCIPAL BEARINGS OF THE MACHINE.

NO.	PLATE	NAME
*130938	-----	Arm, upper and lower (solid) with 15404 and two 15405

NO.	PLATE	NAME
130702	21719	Arm Back Cover
1095F	21707	" " " Screw
51333J	21702	" Oil Plug Screw
130703	21704	" " Tube with 54969 for oiling Needle Bar Connecting Link
130705	21704	Arm Oil Tube with 54969 for oiling Arm Rock Shaft Front Bearing
130706	21704	Arm Oil Tube with 54969 for oiling Arm Rock Shaft Back and Intermediate Bearings
54969	21714	Arm Oil Tube Oil Pad (braided cotton)
130823	21731	Arm Rock Shaft with 624c
130861	---	" " " 130823 with 130769 and 130770
*130708	---	Arm Rock Shaft Bushing (back)
130709	21728	" " " " "
		130708 with 130911
130911	21714	Arm Rock Shaft Bushing (back) Oil Pad (braided cotton)
443c	21703	Arm Rock Shaft Bushing (back) Set Screw
*130907	---	Arm Rock Shaft Bushing (intermediate)
130908	21728	Arm Rock Shaft Bushing (intermediate) 130907 with 130912
130912	21714	Arm Rock Shaft Bushing (intermediate) Oil Pad (braided cotton)
443c	21703	Arm Rock Shaft Bushing (intermediate) Set Screw
130876	21722	Arm Rock Shaft Crank, back (ball bearing solid) with 1177E
1177E	21701	Arm Rock Shaft Crank, back, Clamping Screw
40025	21704	Arm Rock Shaft Crank, back, Pin
*130909	---	" " " Flanged Bushing (front)
130910	21728	Arm Rock Shaft Flanged Bushing (front) 130909 with 130912
130912	21714	Arm Rock Shaft Flanged Bushing (front) Oil Pad (braided cotton)
138756	21737	Arm Rotary Shaft
138757	---	" " " 138756 with 691c and 138759
*130720	---	Arm Rotary Shaft Bushing (front)
130721	21728	" " " " "
		130720 with 130713

NO.	PLATE	NAME
130713	21714	Arm Rotary Shaft Bushing (front) Oil Pad (braided cotton)
443c	21703	Arm Rotary Shaft Bushing (front) Set Screw
*130722	---	Arm Rotary Shaft Bushing (inter- mediate)
130723	21728	Arm Rotary Shaft Bushing (inter- mediate) 130722 with 130713
130713	21714	Arm Rotary Shaft Bushing (inter- mediate) Oil Pad (braided cotton)
448c	21703	Arm Rotary Shaft Bushing (inter- mediate) Set Screw
*130884	---	Arm Rotary Shaft Flanged Bushing (back)
130885	21734	Arm Rotary Shaft Flanged Bushing (back) 130884 with 57974
57974	21714	Arm Rotary Shaft Flanged Bushing (back) Oil Pad (braided cotton)
159F	21703	Arm Rotary Shaft Flanged Bushing (back) Screw
138758	---	Arm Rotary Shaft Oil Sling (back)
138759	21713	" " " " " " 138758 with 130963
130963	21704	Arm Rotary Shaft Oil Sling (back) Oil Tube
691c	21707	Arm Rotary Shaft Oil Sling (back) Set Screw
130730	---	Arm Rotary Shaft Oil Sling (front)
130973	21713	" " " " " " 130730 with 130731
130731	21704	Arm Rotary Shaft Oil Sling (front) Oil Tube
144d	21701	Arm Rotary Shaft Screw
130824	21733	Balance Wheel, 2¼ in. pulley, with two 430c
130870	21733	Balance Wheel Cover
430c	21703	" " Set Screw
130733	21737	Cloth Plate with two 46224
130865	21737	" " Extension
130866	21719	" " " Hinge Stud
130867	21728	" " " " " " Bear- ing with 152e
152e	21707	Cloth Plate Extension Hinge Stud Bearing Clamping Screw
596d	21701	Cloth Plate Extension Hinge Stud Bearing Screw

NO.	PLATE	NAME
889c	21703	Cloth Plate Extension Hinge Stud Set Screw
51262c	21707	Cloth Plate Extension Lock Screw Stud
130868	21719	Cloth Plate Extension Lock Spring
50183F	21701	" " " " " Screw (large)
162F	21701	Cloth Plate Extension Lock Spring Screw (small)
46224	21723	Cloth Plate Oil Cup
130906	21719	" " " Guard
1423J	21707	" " " " Screw
50085F	21703	" " Screw
49016	21726	" " Slide
38419	21726	" " " Spring
725J	21702	" " " " Screw
49017	---	Cloth Plate Slide complete, Nos. 38419, 49016 and two 725J
130734	---	Cloth Plate complete, Nos. 162F, 596d, 894F, 49017, 50183F, 51262c, 130733, 130865 to 130868, 130902, 130906 and two each 889c and 1423J
130877	21726	Crank Connecting Rod (rod only, hollow)
130752	21720	Crank Connecting Rod End Bearing (lower) with two 1057E
1057E	21703	Crank Connecting Rod End Bearing (lower) Cap Screw
130878	21726	Crank Connecting Rod End Bearing (lower) Connection
130754	21719	Crank Connecting Rod End Bearing (lower) Connection Hinge Screw Stud
1664J	21702	Crank Connecting Rod End Bearing (lower) Connecting Hinge Screw Stud Nut
*130879	---	Crank Connecting Rod End Bearing (upper)
896E	21703	Crank Connecting Rod End Bearing (upper) Cap Screw
130881	21726	Crank Connecting Rod End Bearing (upper) complete, Nos. 130879 and two 896E
1756E	21702	Crank Connecting Rod Nut (lower)
1757E	21702	" " " " (upper)

NO.	PLATE	NAME
130882	—	Crank Connecting Rod complete, Nos. 1664J, 1756E, 1757E, 130752, 130754, 130877, 130878 and 130881
130883	—	Crank Connecting Rod 130882 with 130876
130737	21736	Face Plate
193E	21707	" " Screw
130828	21722	Feed Bar with 457c
130738	21722	" " Hinge Pin
457c	21707	" " " " Set Screw
130914	21731	" Connecting Rod with two 896E
896E	21703	" " " Cap Screw
130916	—	" " " 130914 with 130918
130889	21719	Feed Connecting Rod Crank
1480c	21702	" " " " Cap Screw
1396E	21701	Feed Connecting Rod Crank Clamping Screw
130831	21725	Feed Dog, 16 teeth (10 teeth to the inch) for 130856 and 130857
Note: No. 130831 is sent with this machine unless another Feed Dog is specified on order.		
172c	21703	Feed Dog Screw
*130917	—	" Eccentric
*130891	—	" " Body
51061c	21707	" " " Set Screw
7071	21714	" " Clamping Washer
217J	21707	" " " " Screw
130918	21718	Feed Eccentric (adjustable) complete, Nos. 217J, 1103c, 7071, 130891, 130917 and two 51061c
130833	21718	Feed Lifting Cam with two 1036c
130834	21720	" " " Connection with 457c and two 175E
175E	21703	Feed Lifting Cam Connection Cap Screw
130871	21718	Feed Lifting Cam Connection Collar
130836	21704	" " " " Hinge Pin
457c	21707	Feed Lifting Cam Connection Hinge Pin Set Screw

NO.	PLATE	NAME
1036c	21703	Feed Lifting Cam Set Screw
1103c	21707	" Regulating Screw
130893	21731	" Rocking Frame with 1396E
130894	—	" " " 130893 with 130746
11398	21727	Feed Rocking Frame Hinge Pin
*58293	—	" " " " " " 11398 with 1508E
1508E	21702	Feed Rocking Frame Hinge Pin Nut
622c	21702	Feed Rocking Frame Hinge Pin Screw Bushing
1508J	21702	Feed Rocking Frame Hinge Pin Screw Bushing Nut
130746	21714	Feed Rocking Frame Oil Pad (braided cotton)
27398	21704	Feed Rocking Frame Washer
120969	21710	Guide
194D	21707	" Screw Stud
671D	21701	" Thumb Screw
130838	21724	Looper, for single thread
130839	21724	" " double thread
130748	21731	" Bell Crank with 1147c, 130749 and 130939
46228	21724	Looper Bell Crank Ball Stud
1147c	21703	" " " " " Set Screw
130750	21727	Looper Bell Crank Connection with two 171E
130872	—	Looper Bell Crank Connection 130750 with 46228
171E	21703	Looper Bell Crank Connection Cap Screw
130752	21720	Looper Bell Crank Connection Driver with two 1057E
1057E	21703	Looper Bell Crank Connection Driver Cap Screw
130754	21719	Looper Bell Crank Connection Hinge Screw Stud
1664J	21702	Looper Bell Crank Connection Hinge Screw Stud Nut
130755	21727	Looper Bell Crank Hinge Stud
435c	21703	" " " " " Set Screw (lower)
448c	21703	Looper Bell Crank Hinge Stud Set Screw (upper)

NO.	PLATE	NAME
130749	21714	Looper Bell Crank Oil Pad (felt)
130939	21704	" " " " Retainer
130756	21724	" Carrier with 130760 and three 1147c
130757	21722	Looper Carrier Connection with four 175E
130873	---	Looper Carrier Connection 130757 with 130956 and 130970
130970	21724	Looper Carrier Connection Ball Screw Stud (right)
1518J	21702	Looper Carrier Connection Ball Screw Stud (right) Nut
49043	21704	Looper Carrier Connection Ball Screw Stud (right) Washer (fibre)
130956	21724	Looper Carrier Connection Ball Stud (left)
1147c	21703	Looper Carrier Connection Ball Stud (left) Set Screw
49043	21704	Looper Carrier Connection Ball Stud (left) Washer (fibre)
175E	21703	Looper Carrier Connection Cap (left) Screw
175E	21703	Looper Carrier Connection Cap (right) Screw
130759	21724	Looper Carrier Hinge Stud
49166	21724	" " " " Collar with two 202F
202F	21707	Looper Carrier Hinge Stud Collar Set Screw
896E	21703	Looper Carrier Hinge Stud Set Screw
130760	21714	Looper Carrier Oil Pad (braided cotton)
130761	21721	Looper Carrier Rock Shaft
130762	21721	" " " " Crank (back), forked, with 51313c
51313c	21703	Looper Carrier Rock Shaft Crank (back) Position Screw
49049	21721	Looper Carrier Rock Shaft Crank (back) Slide Block
130763	21721	Looper Carrier Rock Shaft Crank (front) with 896E and two 157E
157E	21701	Looper Carrier Rock Shaft Crank (front) Clamping Screw
130840	21720	Looper and Thread (under) Take-up Eccentric with two 1036c

NO.	PLATE	NAME
1036c	21703	Looper and Thread (under) Take-up Eccentric Set Screw
130765	21733	Looper Gate
63c	21701	" " Hinge Screw
2818	21704	" " " " Friction Washer
1147c	21703	Looper Set Screw
130841	21734	Needle Bar (hollow)
130842	21727	" " Bushing (lower)
435E	21703	" " " " Set Screw
130843	21727	Needle Bar Bushing (upper)
1133E	21707	" " " " Set Screw
130769	21716	Needle Bar Connecting Link
130875	---	" " " " 130769 with 130770 and 130844
*130770	---	Needle Bar Connecting Link Hinge Pin
624c	21703	Needle Bar Connecting Link Hinge Pin Set Screw
130844	21727	Needle Bar Connecting Stud with 1454E
1454E	21703	Needle Bar Connecting Stud Clamping Screw
130941	21714	Needle Bar Oil Pad (felt)
130942	21713	" " " " Retainer
316c	21703	" " " " " Screw
1753c	21702	" Clamping Nut
130845	21720	" Guard
162D	21701	" " Screw
130964	21734	Oil Reservoir
130965	21736	" " Cover
50116D	21707	" " " Hinge Screw
130953	21714	" " " " " Friction Washer
1127D	21707	Oil Reservoir Cover Thumb Screw
*130776	---	" " Oil Pipe for 130966
130966	21735	" " " " 130776 with 130784, for oiling Arm Rotary Shaft Back Bearing
*130784	---	Oil Reservoir Oil Pipe Joint for 130966
*130779	---	Oil Reservoir Oil Pipe for 130967
130967	21735	" " " " 130779 with 130778, for oiling Arm Rotary Shaft Intermediate Bearing

NO.	PLATE	NAME
*130778	—	Oil Reservoir Oil Pipe Joint for 130967
*130782	—	Oil Reservoir Oil Pipe for 130783
130783	21735	" " " " 130782 with 130784, for oiling Looper Bell Crank Connection Driver
*130784	—	Oil Reservoir Oil Pipe Joint for 130783
*130785	—	Oil Reservoir Oil Pipe for 130968
130968	21735	" " " " 130785 with 130778, for oiling Arm Rotary Shaft Front Bearing
*130778	—	Oil Reservoir Oil Pipe Joint for 130968
130787	21710	Oil Reservoir Oil Pipe Clamping Plate
176J	21701	Oil Reservoir Oil Pipe Clamping Plate Screw
130788	21710	Oil Reservoir Oil Pipe Position Plate
130789	21710	Oil Reservoir Oil Tube for 130967 and 130968
130791	21710	Oil Reservoir Oil Tube for 130783 and 130966
130957	21710	Oil Reservoir Oil Tube for oiling Crank Connecting Rod (upper) Bearing
130793	21730	Oil Reservoir Oil Tube Wick (9 strands) for 130783
130794	21730	Oil Reservoir Oil Tube Wick (6 strands) for 130967 and 130968
130795	21730	Oil Reservoir Oil Tube Wick (8 strands) for 130966
130797	21730	Oil Reservoir Oil Tube Wick (5 strands) for 130957
130969	—	Oil Reservoir complete, Nos. 1127D, 50116D, 130793, 130795, 130797, 130953, 130957, 130964, 130965 and two each 130789, 130791 and 130794
50152D	21701	Oil Reservoir Screw for 130969
130899	21710	" " for 130902
130900	21704	" " Oil Tube (brass)
130901	21719	" " " Wick (wick)
130902	—	Oil Reservoir complete, for oiling Feed Connecting Rod, for 130731. Nos. 130899 to 130901

NO.	PLATE	NAME
894F	21701	Oil Reservoir Screw, for 130902
130799	21734	Presser Bar
130800	21721	" " Bushing (lower)
435E	21703	" " " " Set Screw
49061	21727	Presser Bar Bushing (upper)
1133E	21707	" " " " Set Screw
49062	21723	Presser Bar Lifter
212D	21707	" " " Cap Screw
49063	21704	" " " Friction Washer
49064	21723	" " " Hinge Stud
453C	21703	" " " " " Set Screw
130801	9440	Presser Bar Lifting Bracket with 453c and 892F
892F	21702	Presser Bar Lifting Bracket Adjusting Screw
453C	21703	Presser Bar Lifting Bracket Set Screw
49066	21723	Presser Bar Lifting Link
212D	21707	" " " " Cap Screw
724C	21707	" " " " Hinge Screw
49067	21734	Presser Bar Spring (flat)
38468	21716	" " " Stud
130949	21712	" Foot (solid) to make two to four stitches to the inch
51242C	21703	Presser Foot Hinge Screw
130846	—	" " Plate for 130848
130929	—	" " " " 130930
130950	—	" " " " 130952
130847	—	" " Shank
130951	—	" " " for 130952
130848	21712	Presser Foot (hinged) complete, to make three to four stitches to the inch, Nos. 51242c, 130846 and 130847
130952	21712	Presser Foot (hinged) complete, to make two to four stitches to the inch, Nos. 51242c, 130950 and 130951

Note: Presser Foot No. 130952 is sent with this machine unless another Presser Foot is specified on order.

NO.	PLATE	NAME
130930	21712	Presser Foot (hinged) complete, to make three to four stitches to the inch, Nos. 51242c, 130847 and 130929
190J	21707	Presser Foot Screw
574w	21701	Pressure Regulating Thumb Screw
1539w	21702	" " " "
		Lock Nut
130959	21723	Slack Thread Controller
1095F	21707	" " " Screw
2102	21723	Tension (under thread) Disc
51570c	21702	" " " Regulating Thumb Nut
50326c	21701	Tension (under thread) Screw Stud
59539	—	" " " " " " 50326c with 51570c
59534	9440	Tension (under thread) Spring
59537	21723	" " " " Bushing (large)
59538	9440	Tension (under thread) Spring Bushing (small)
32572	21723	Tension (under thread) Spring Washer
130807	9440	Tension (under thread) Thread Guide
50530K	21702	Tension (upper thread, automatic) Body
15770	21723	Tension (upper thread, automatic) Cap
130808	21723	Tension (upper thread, automatic) Releasing Cam with 1036c
1036c	21703	Tension (upper thread, automatic) Releasing Cam Set Screw
130809	21704	Tension (upper thread, automatic) Releasing Pin
9540	21724	Tension (upper thread, automatic) Spring
848K	21707	Tension (upper thread, automatic) Stud
9541	21704	Tension (upper thread, automatic) Stud Plug (micarda)
34527	—	Tension (upper thread, automatic) complete, Nos. 848K, 9540, 9541, 15770 and 50530K
130849	9440	Tension (upper thread, automatic) Thread Guide

NO.	PLATE	NAME
190J	21707	Tension (upper thread, automatic) Thread Guide Screw
2102	21723	Tension (upper thread) Disc
51570c	21702	" " " Regulating Thumb Nut
50326c	21701	Tension (upper thread) Screw Stud
59539	—	" " " " " " 50326c with 51570c
59534	9440	Tension (upper thread) Spring
59537	21723	" " " " Bushing (large)
59538	9440	Tension (upper thread) Spring Bushing (small)
32572	21723	Tension (upper thread) Spring Washer
130850	21705	Tension (upper thread) Thread Guide
130851	21705	Thread (under) Take-up
130862	21705	" " " Connection (forked) with two 1057E
1057E	21703	Thread (under) Take-up Connection Cap Screw
130864	9440	Thread (under) Take-up Connection Slide Block
190J	21707	Thread (under) Take-up Screw
130811	9440	" " " Thread Guide
175J	21703	" " " " " " Screw
130812	21723	Thread (under) Thread Guide (back of arm)
1423J	21707	Thread (under) Thread Guide Screw
130853	21706	Thread (upper) Controller
1095F	21707	" " " Adjusting Screw
691F	21707	Thread (upper) Controller Screw
130854	21723	" " " Thread Screw Eyelet
1708J	21702	Thread (upper) Controller Thread Screw Eyelet Lock Nut
130855	21705	Thread (upper) Take-up with 457c
457c	21707	" " " Set Screw
130856	21725	Throat Plate with 665J and 130858, for 130831 for single thread
130857	21725	Throat Plate for 130831, for double thread

NO.	PLATE	NAME
691f	21707	Throat Plate Screw
130858	21725	" " Thread Retainer
665J	21707	" " " " Screw
*15404	---	Trade Mark
15405	---	" " Rivet

FITTINGS FOR 157-1 MACHINE

FOR 4 TO 8 STITCHES TO THE INCH, FOR SUGAR OR FLOUR BAGS OF COTTON MATERIAL.

NO.	PLATE	NAME
130739	21709	Feed Dog, 13 teeth (14 teeth to the inch) for 130816 and 130982
130802	---	Presser Foot for 132805
130803	---	" " Compensating Plate for 130805
226J	21707	Presser Foot Compensating Plate Screw
130804	21724	Presser Foot Compensating Plate Spring
130805	21709	Presser Foot (compensating) complete, Nos. 226J and 130802 to 130804
50087c	21703	Presser Foot Hinge Screw for 130981
130979	---	Presser Foot Plate for 130981
130980	---	" " Shank for 130981
130981	21709	Presser Foot (hinged) complete, Nos. 50087c, 130979 and 130980
130816	21709	Throat Plate, for double thread, for 130739
130982	21709	Throat Plate (keyhole type needle hole) for double thread, for 130739

FOR 4 TO 8 STITCHES TO THE INCH, FOR SUGAR OR FLOUR BAGS OF COTTON MATERIAL.
(Narrow Feeding Surface)

130983	21717	Feed Dog, 15 teeth (14 teeth to the inch) for 130991
130984	---	Presser Foot for 130985
130803	---	" " Compensating Plate for 130985
226J	21707	Presser Foot Compensating Plate Screw
130804	21724	Presser Foot Compensating Plate Spring

NO.	PLATE	NAME
130985	21717	Presser Foot (compensating) complete, Nos. 226J, 130803, 130804 and 130984
130986	21724	Presser Foot Hinge Pin for 130989
130987	---	" " Plate for 130989
130988	---	" " Shank for 130989
130989	21717	Presser Foot (hinged) complete, Nos. 130986 to 130988
130990	21717	Presser Foot (solid)
130991	21717	Throat Plate (keyhole type needle hole) for double thread, for 130983

FOR 3½ TO 8 STITCHES TO THE INCH, FOR SUGAR OR FLOUR BAGS OF COTTON MATERIAL OR LIGHT BURLAP.

130935	21715	Feed Dog, 15 teeth (10 teeth to the inch) without thread channel for 130926, 130927, 130936 and 130937
130934	21725	Feed Dog, 15 teeth (10 teeth to the inch) with thread channel .005" deep for 130926, 130927, 130936 and 130937
130971	21711	Feed Dog, 15 teeth (10 teeth to the inch) with thread channel .007" deep for 130926, 130927, 130936 and 130937
130919	21729	Feed Dog, 15 teeth (10 teeth to the inch) with thread channel .015" deep for 130926, 130927, 130936 and 130937
130923	---	Presser Foot for 130925
130924	---	" " Compensating Plate for 130925
226J	21707	Presser Foot Compensating Plate Screw
130804	21724	Presser Foot Compensating Plate Spring
130925	21711	Presser Foot (compensating) complete, Nos. 226J, 130804, 130923 and 130924
51242c	21703	Presser Foot Hinge Screw
130992	21711	" " Needle Guard for 130994
217J	21707	" " " " Screw for 130994
130993	---	Presser Foot Plate for 130994
137070	---	" " Shank for 130994

NO.	PLATE	NAME
130994	21711	Presser Foot (hinged) complete, for sewing bags having frayed edges, Nos. 217J, 51242c, 130992, 130993 and 137070
51242c	21703	Presser Foot Hinge Screw
130929	—	" " Plate for 130930
130847	—	" " Shank for 130930
130930	21712	Presser Foot (hinged) complete, Nos. 51242c, 130847 and 130929
130922	21711	Presser Foot (solid)
130926	21729	Throat Plate with 665J and 130928, for single thread for 130919, 130920, 130934, 130935 and 130971
130936	21711	Throat Plate (keyhole type needle hole) with 665J and 130928, for single thread, for 130919, 130920, 130934, 130935 and 130971
130928	21729	Throat Plate Thread Retainer for 130926 and 130936
665J	21707	Throat Plate Thread Retainer Screw for 130926 and 130936
130927	21729	Throat Plate for double thread, for 130919, 130920, 130934, 130935 and 130971
130937	21715	Throat Plate (keyhole type needle hole) for double thread, for 130919, 130920, 130934, 130935 and 130971

FOR 3½ TO 8 STITCHES TO THE INCH, FOR MEDIUM WEIGHT BURLAP BAGS.

Note: The same Presser Feet and Throat Plates are used for medium weight burlap bags as listed in preceding set of fittings.

130920	21729	Feed Dog, 12 teeth (8 teeth to the inch) for 130926, 130927, 130936 and 130937
--------	-------	--

FOR 3½ TO 6 STITCHES TO THE INCH, FOR BAGS OF HEAVY WEIGHT BURLAP HAVING FRAYED EDGES.

130995	21711	Feed Dog, 12 teeth (8 teeth to the inch) for 130999 and 131000
51242c	21703	Presser Foot Hinge Screw
130992	21711	" " Needle Guard for 130998
217J	21707	" " " Screw
130996	—	" " Plate for 130998
130997	—	" " Shank for 130998

NO.	PLATE	NAME
130998	21715	Presser Foot (hinged in center) complete, Nos. 217J, 51242c, 130992, 130996 and 130997
130999	21715	Throat Plate with 665J and 130928, for single thread, for 130995
130928	21729	Throat Plate Thread Retainer for 130999
665J	21707	Throat Plate Thread Retainer Screw for 130999
131000	21716	Throat Plate for double thread, for 130995

FOR 3½ TO 6 STITCHES TO THE INCH, FOR BAGS OF LIGHT OR MEDIUM WEIGHT BURLAP OR SIMILAR MATERIAL.

(Two row feeding surface)

138751	21708	Feed Dog, 15 teeth (10 teeth to the inch) for 138754 and 138755
51242c	21703	Presser Foot Hinge Screw
138752	—	" " Plate
130847	—	" " Shank
138753	21708	Presser Foot (hinged) complete, Nos. 51242c, 130847 and 138752
138754	21708	Throat Plate with 665J and 130928, for single thread, for 138751
130928	21729	Throat Plate Thread Retainer for 138754
665J	21707	Throat Plate Thread Retainer Screw for 138754
138755	21708	Throat Plate for double thread, for 138751

ACCESSORIES

NO.	PLATE	NAME
120344	6201	Oiler (copper plated) with 120345
120345	6201	" Spout, 5 in. long
11831	6201	Screw Driver (large)
26026	6201	" " (small)
120341	6201	Tweezers (curved)
8909	6201	Wrench for 1518
19079	6201	" " 1629
23766	6201	" " 1508 and 1518

MACHINE BASE

NO.	PLATE	NAME
130954	21738	Machine Base
51329E	21702	" " Oil Hole Screw Plug
50144J	21734	" " Thumb Screw with 49095
49095	21718	Machine Base Thumb Screw Washer
130818	21736	" Cushion (left) felt
130819	21736	" " (right) felt
50339E	21701	" Screw, to fasten machine to base
130820	21719	Machine Screw Washer (leather)
130955	---	Machine Base complete, Nos. 51329E, 130818, 130819, 130954 and three each 50339E and 130820

MACHINE BASE OIL DRAIN JAR

(Swinging Type)

NO.	PLATE	NAME
131185	20526	Jar (glass)
131191	20526	" Cap
131188	20526	" Clamp
131217	---	" " 131188 with 131189
131189	20526	" " Lever
1247C	21703	" " " Hinge Screw
131265	20526	Nipple (long)
131266	20526	" (short)
131267	20526	" Elbow
131268	---	Machine Base Oil Drain Jar (swinging type) complete, Nos. 131185, 131191, 131217, 131266 and two each 1247C, 131265 and 131267

FOOT LIFTER PARTS

NO.	PLATE	NAME
6439	---	Chain, length 36 in. to 45 in., with 56864 and 56865
Note: When ordering No. 6439, state length required.		
4879	21716	Chain Connecting Link
56864	21716	" Hook (large)
56865	21716	" " (small)
130943	21733	Lifting Lever
130944	21705	" " Connection
130945	---	" " " 130944 with 12761

NO.	PLATE	NAME
12761	21716	Lifting Lever Connection Hinge Pin
9D	21701	" " Hinge Screw
130946	21734	" " Spring
57286	21732	Treadle
4882	21732	" Shaft
4883	21732	" Spring
4884	21732	" Stand
423C	21703	" Stop Screw
1650C	21702	" " " Nut
57287	---	Treadle complete, Nos. 4879, 4882 to 4884, 57286, two each 423C, 1650C and wood screws 1 in. No. 16
130947	---	Foot Lifter complete, Nos. 9D, 6439, 57287, 130943, 130945 and 130946

KNEE LIFTER PARTS

NO.	PLATE	NAME
37563	---	Chain, length 15 in., with 56864 and 56865
56864	21716	Chain Hook (large)
56865	21716	" " (small)
130943	21733	Lifting Lever
130944	21705	" " Connection
130945	---	" " " 130944 with 12761
12761	21716	Lifting Lever Connection Hinge Pin
9D	21701	" " Hinge Screw
130946	21734	" " Spring
2763	21738	Rock Shaft
12242	21738	" " Hanger with two wood screws 1 in. No. 10
2765	21738	Rock Shaft Knee Arm
2766	21738	" " " " Hub with 356C
356C	21703	" " " " Set Screw
2768	---	Rock Shaft Knee Arm complete, Nos. 2765 to 2767
2767	21738	Rock Shaft Knee Plate with 356C
356C	21703	" " " " Set Screw
6337	21738	" " Lifting Bracket with two 356C
7125	21738	Rock Shaft Lifting Bracket Hook
356C	21703	" " " " " " Set Screw
356C	21703	Rock Shaft Lifting Bracket Set Screw

NO.	PLATE	NAME
2770	21738	Rock Shaft Stop Dog with 356c
356c	21703	" " " " Set Screw
42143	21738	Rock Shaft complete, Nos. 2763, 2768, 6337, 7125 and two each 2770 and 12242
130948	—	Knee Lifter complete, Nos. 9d, 37563, 42143, 130943, 130945 and 130946

THREAD UNWINDER

(For two spools)

NO.	PLATE	NAME
225257	20335	Spool Rest (for two spools) with 201018c
150203	20335	Spool Rest Cushion (felt)
225388	20335	" " Rod
200383c	21707	" " " Set Screw
201018c	21707	" " Set Screw
202490	20335	" Stand with 200383c
225391	20335	Thread Guide
201696j	21702	" " Lock Nut
225326	20335	" " Position Cup
225324	20335	" " Rod with 208E and 225322
208E	21707	Thread Guide Rod Screw
225322	21702	" " Washer
225258	20335	Thread Unwinder complete, Nos. 201696j, 202490, 225257, 225324, 225326, 225388, two each 150203, 225391 and three wood screws $\frac{3}{4}$ in. No. 12

TIMING GAUGE

NO.	PLATE	NAME
130903	21706	Timing Gauge Frame with 452c
130904	21706	" " Indicator Pin
452c	21703	" " " " Set Screw
130905	—	Timing Gauge complete, Nos. 130903 and 130904

PLATE 6201—ONE-HALF SIZE

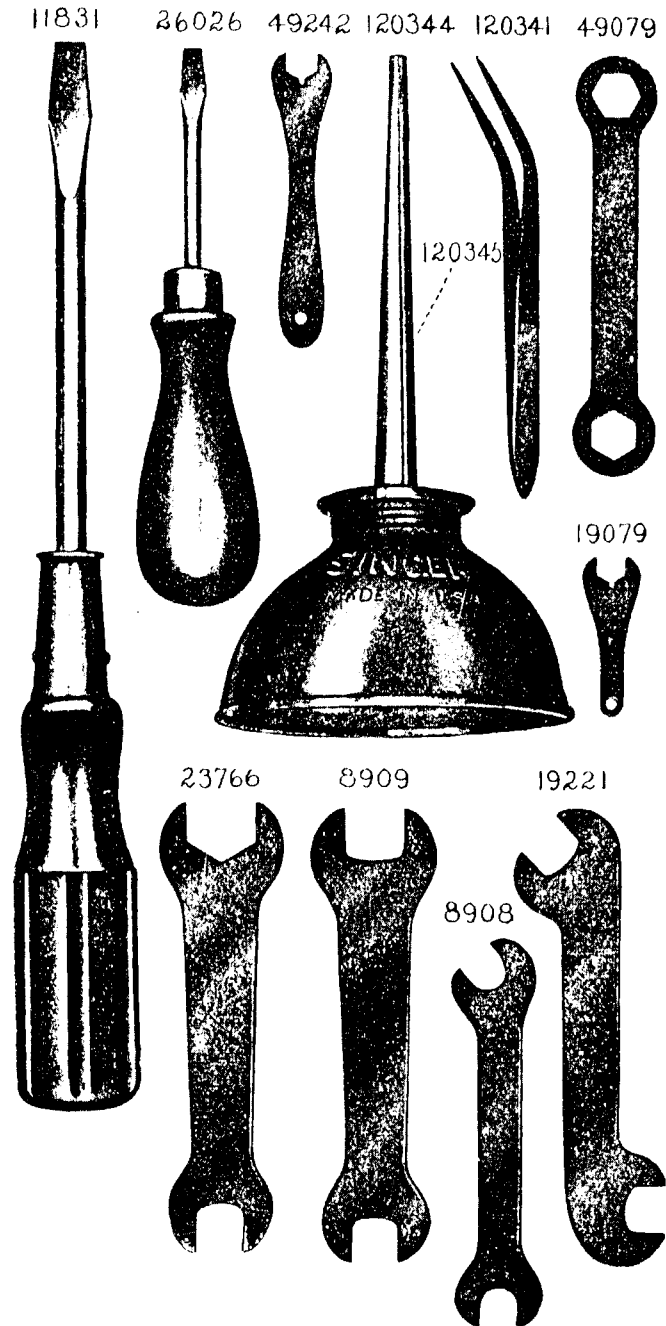


PLATE 9440—FULL SIZE

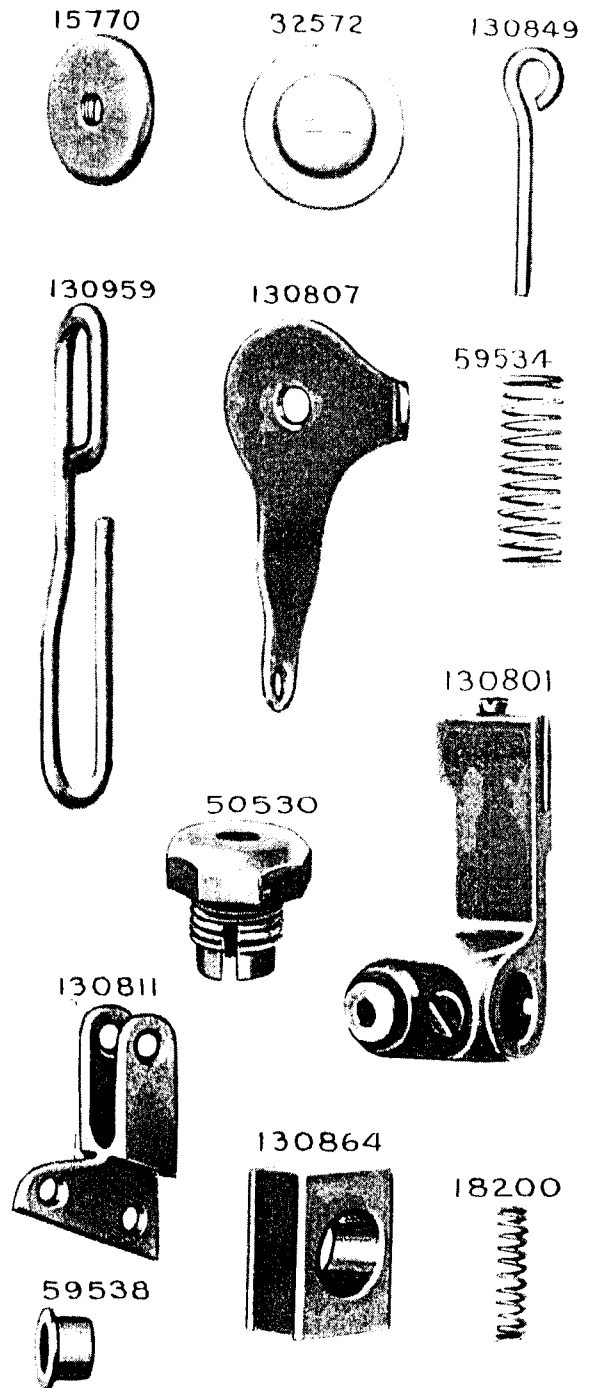


PLATE 20335 ONE-SIXTH SIZE

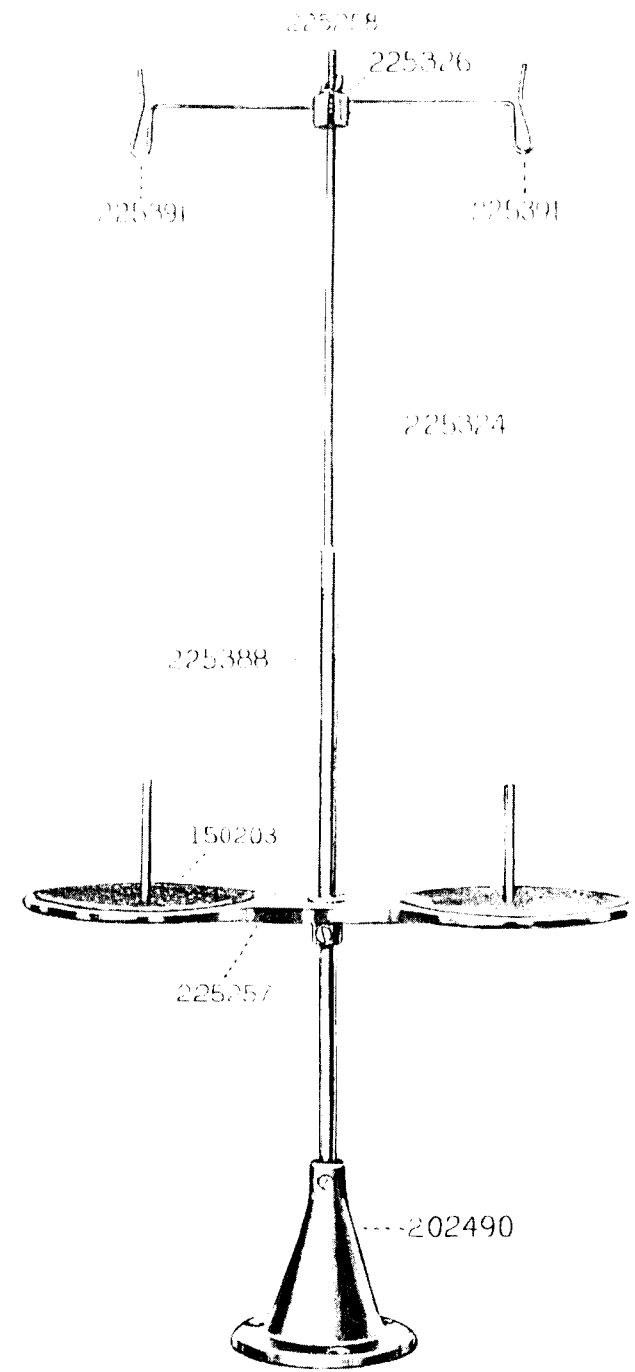


PLATE 20526—ONE-HALF SIZE

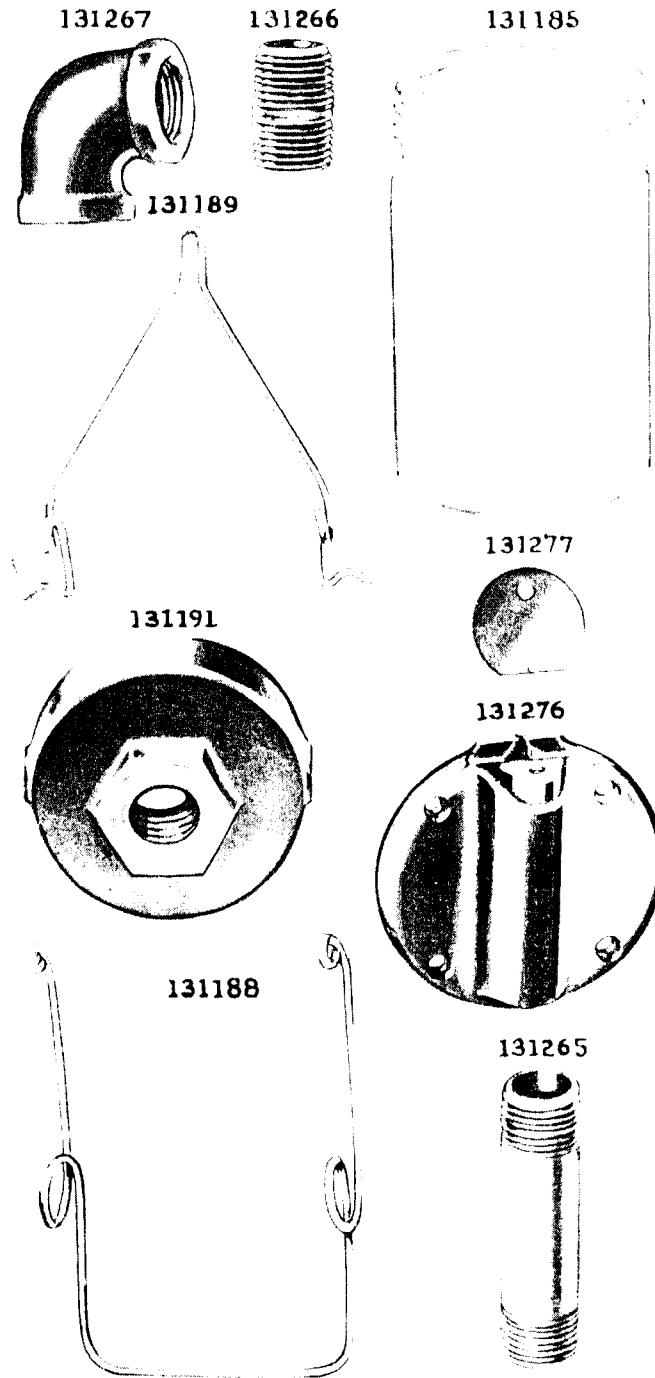


PLATE 21701—FULL SIZE

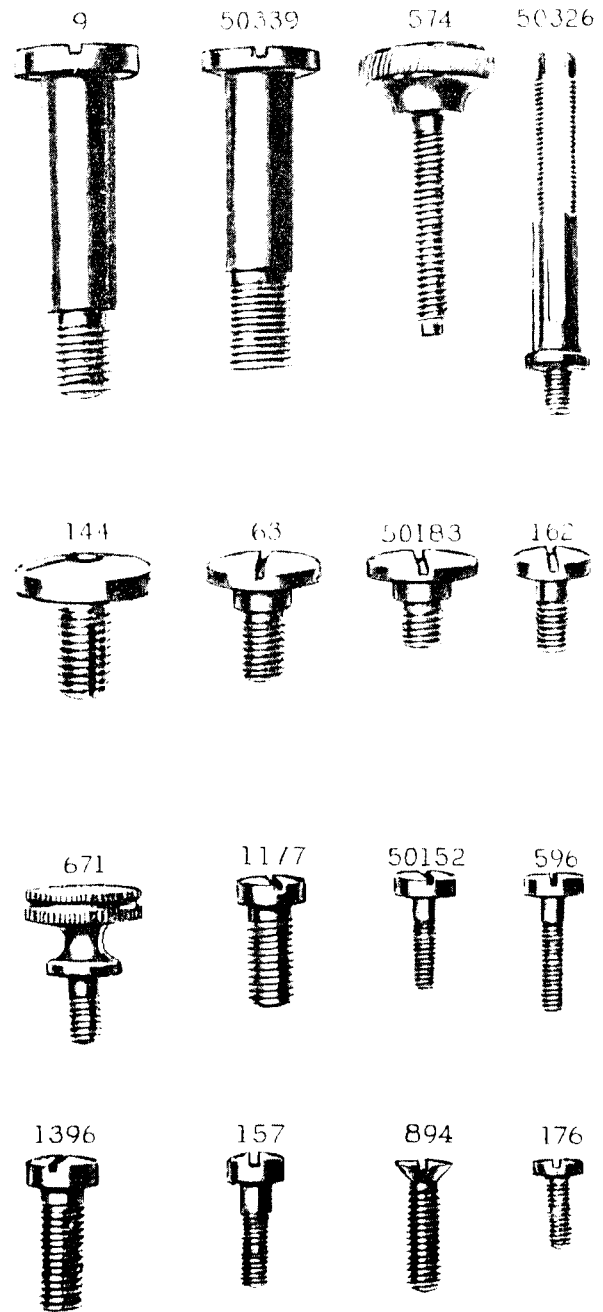


PLATE 21702 - FULL SIZE

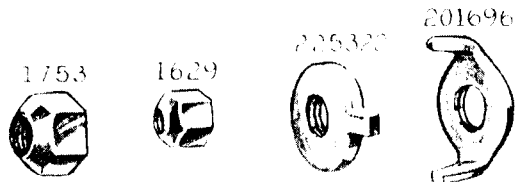
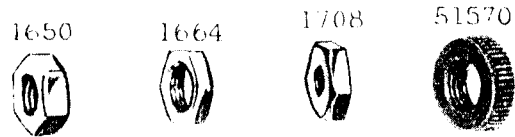
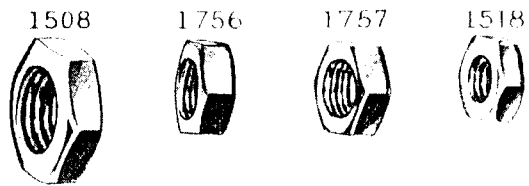
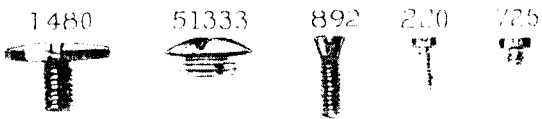
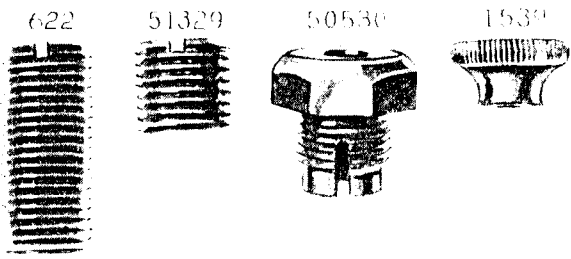


PLATE 21703 - FULL SIZE

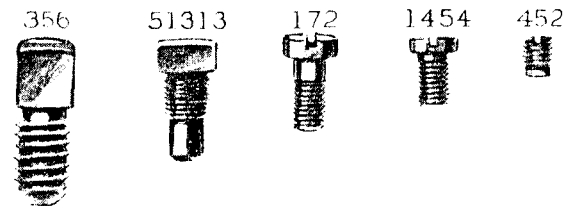
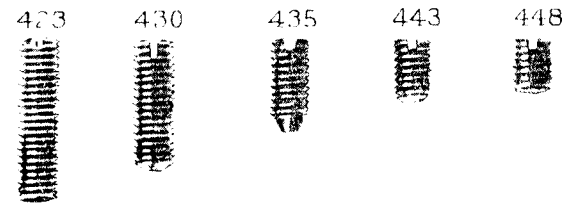
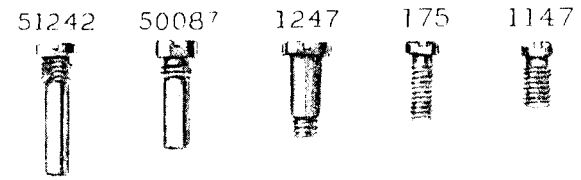
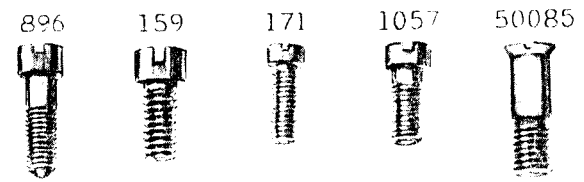
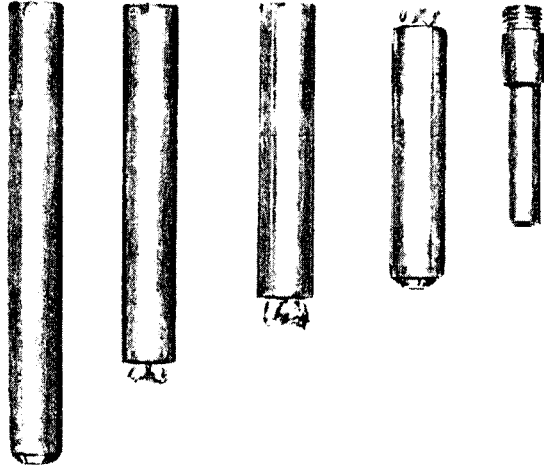
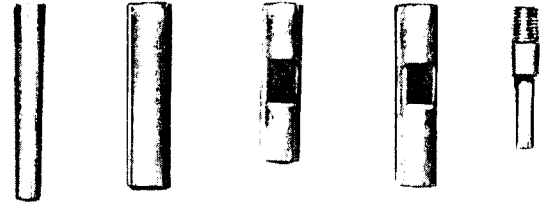


PLATE 21704—FULL SIZE

130704 130705 130706 130703 130963



40025 130809 49030 130836 130731



130898 2653 130939 130900 9541



27398 2818 49043 49063

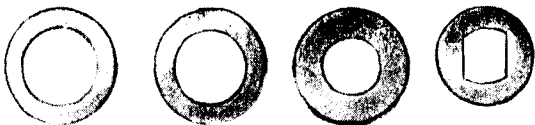
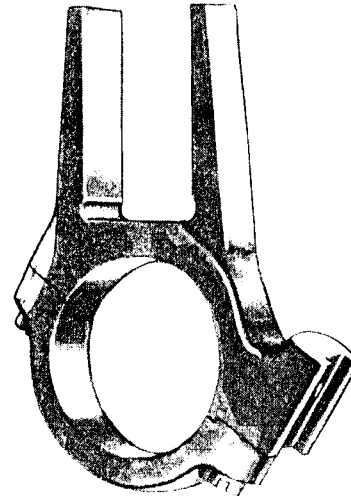
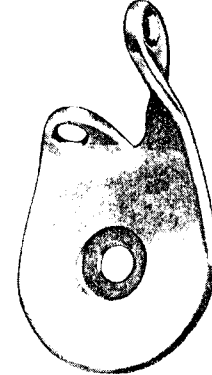


PLATE 21705—FULL SIZE

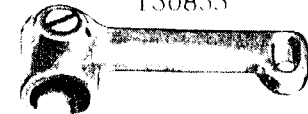
130862



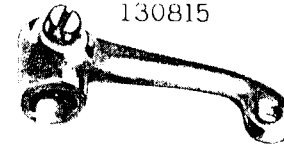
130850



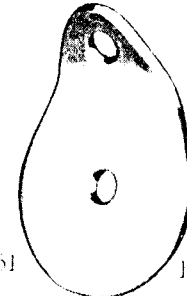
130855



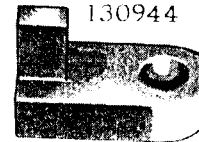
130815



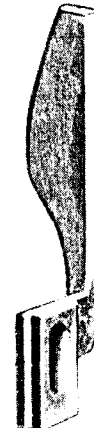
49220



130944



130931



130851



130810



PLATE 21706—FULL SIZE

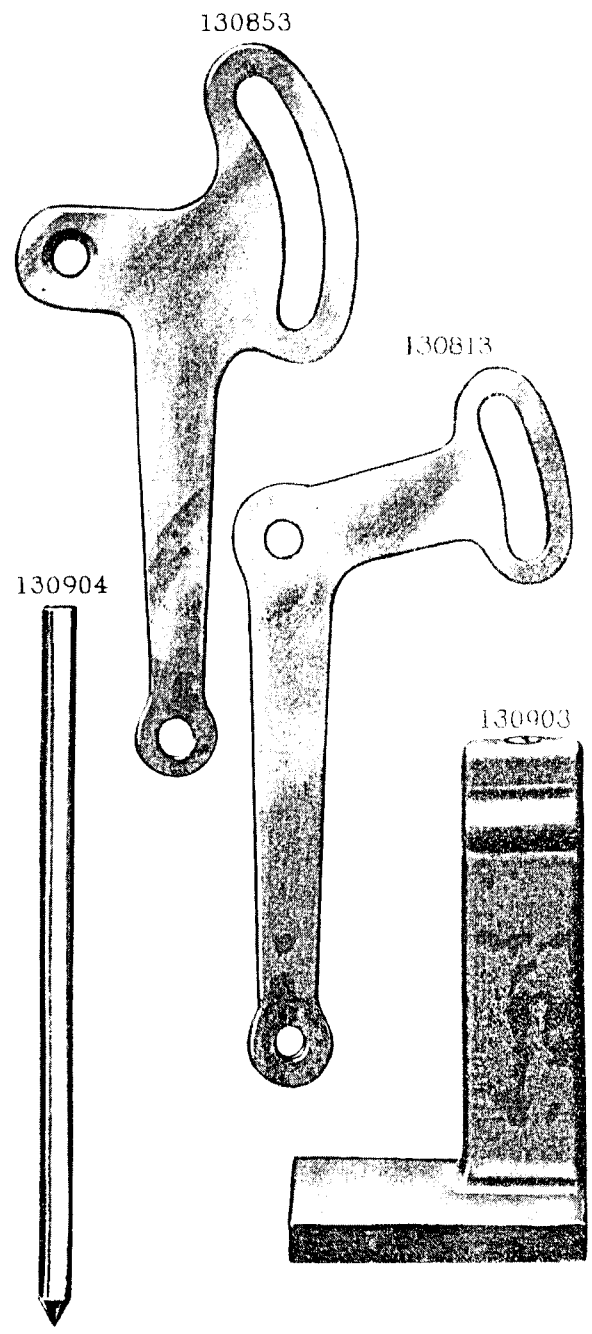


PLATE 21707—FULL SIZE

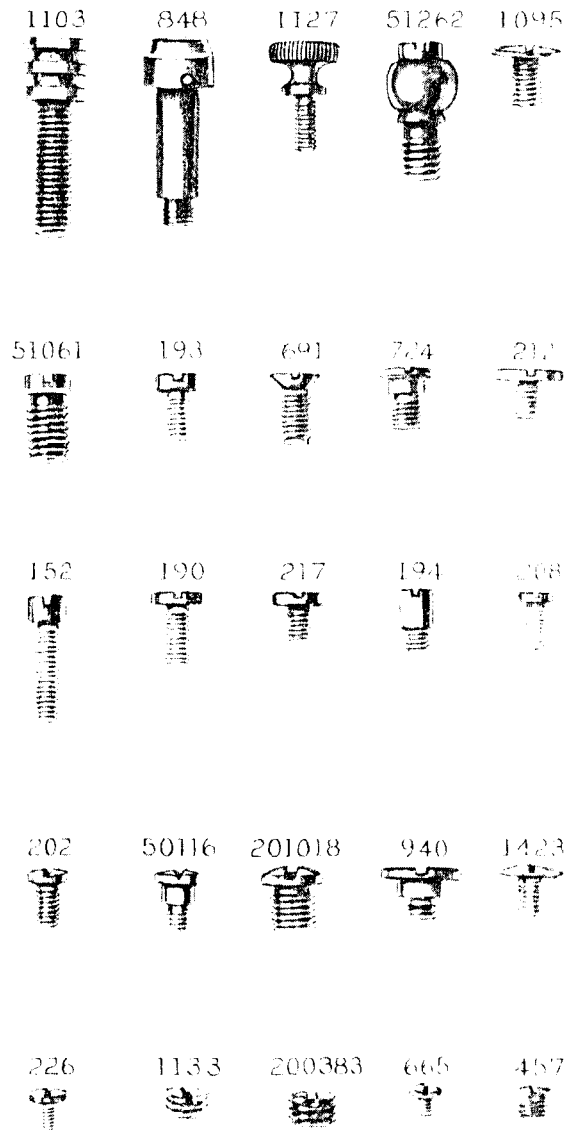
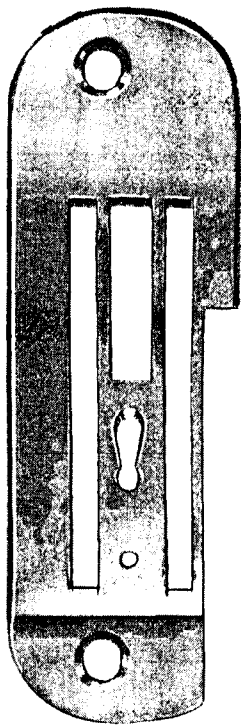
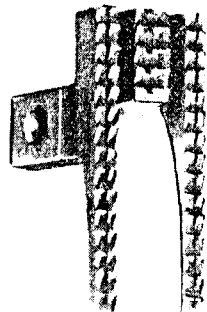


PLATE 21708--FULL SIZE

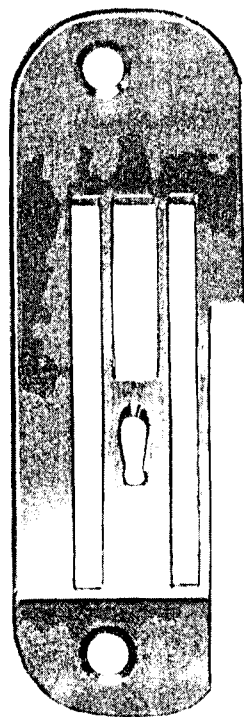
138754



138751



138755

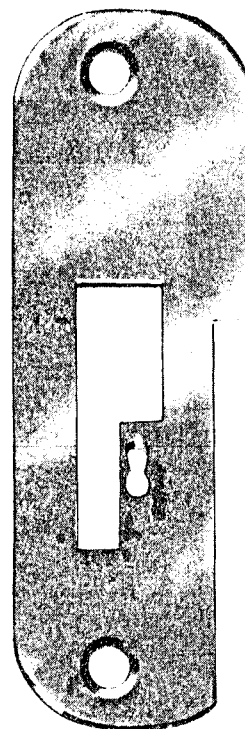


138753



PLATE 21709--FULL SIZE

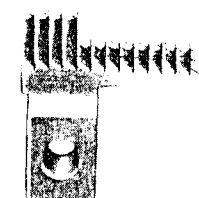
130982



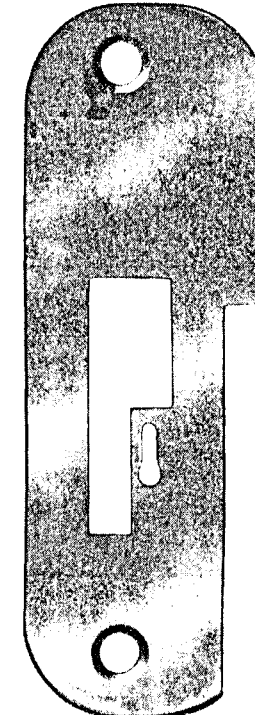
130981



130739



130816



130805

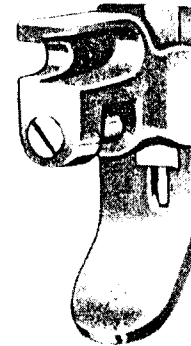
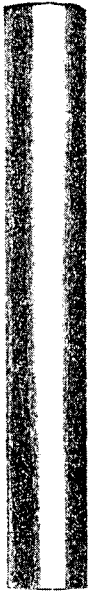
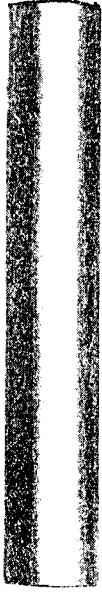


PLATE 21710—FULL SIZE

130789



130791



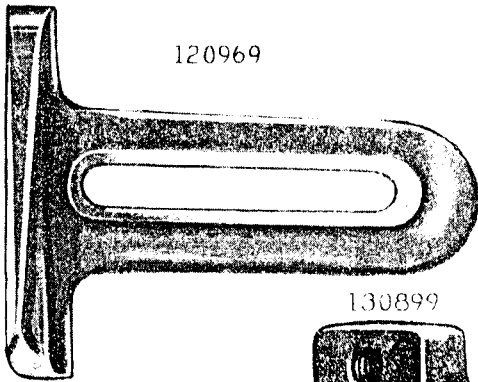
130957



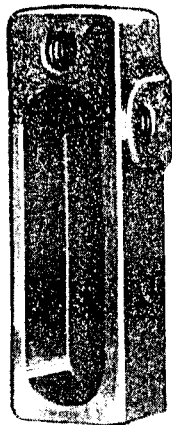
130788



120969



130899

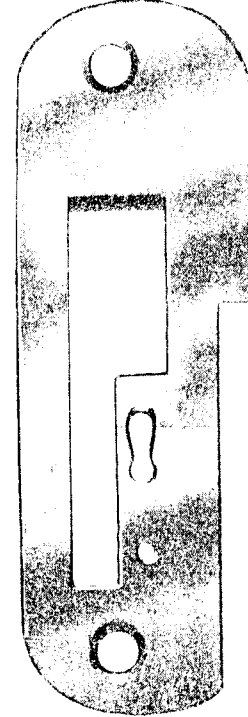


130787

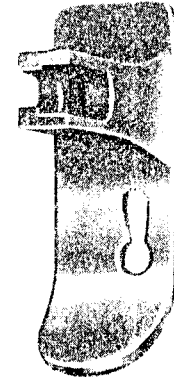


PLATE 21711—FULL SIZE

130936



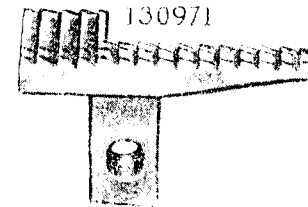
130922



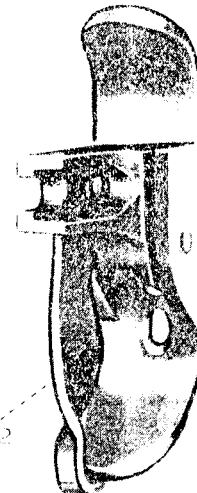
130925



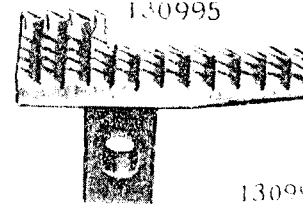
130971



130994



130995



130992

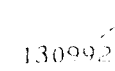
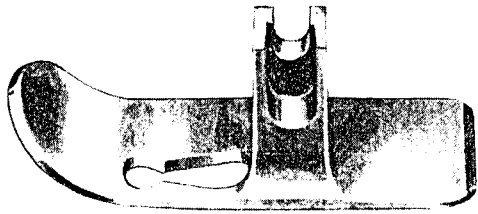
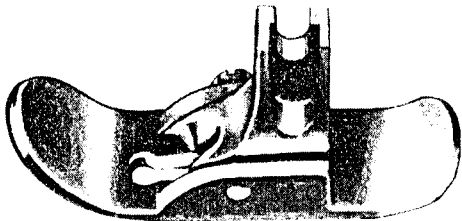


PLATE 21712--FULL SIZE

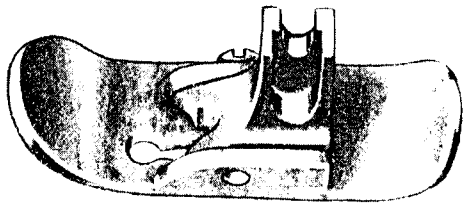
130949



130930



130848



130952

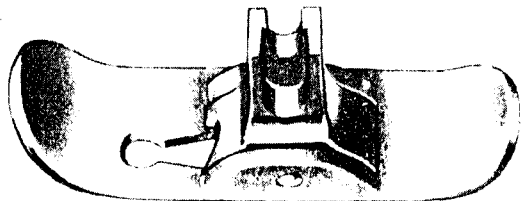
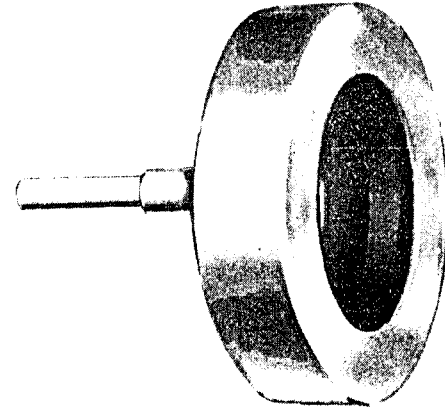
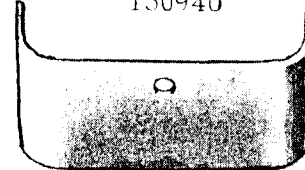


PLATE 21713--FULL SIZE

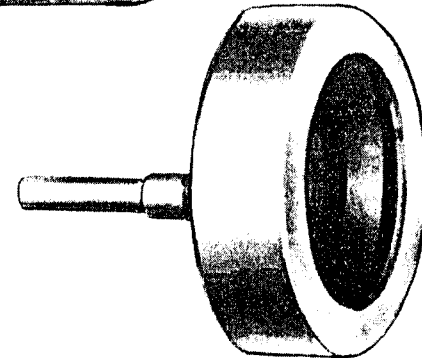
138759



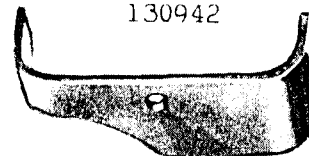
130940



130972



130942



130973

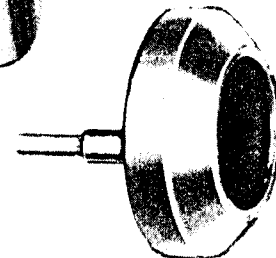


PLATE 21714-FULL SIZE

130912



130746



54969



130911



57974



130713



130760



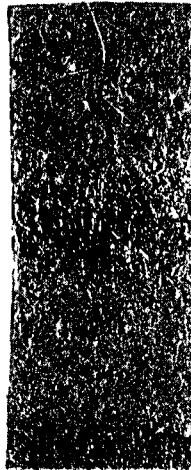
55515



130749



130932



130941



130953

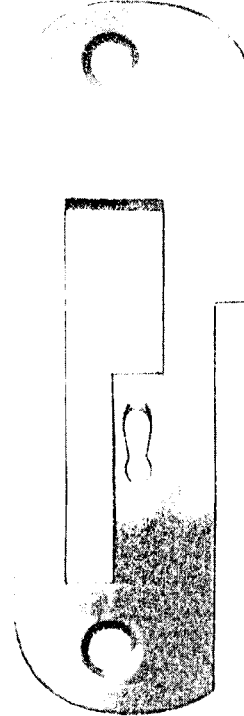


7071

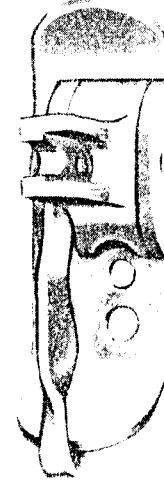


PLATE 21715-FULL SIZE

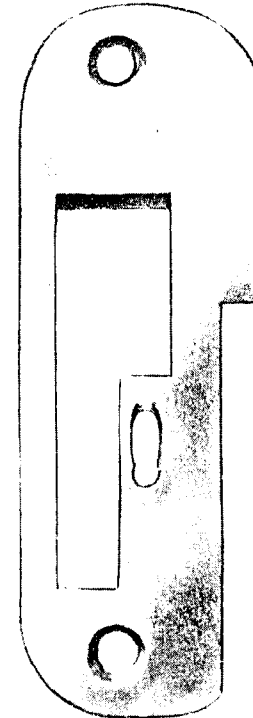
130937



130998



130999



130935

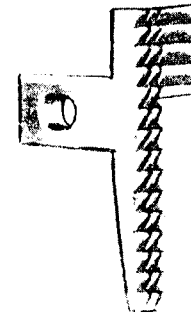
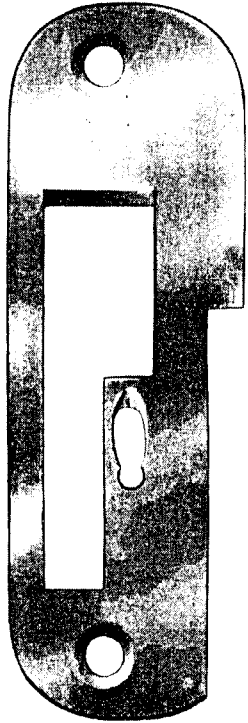
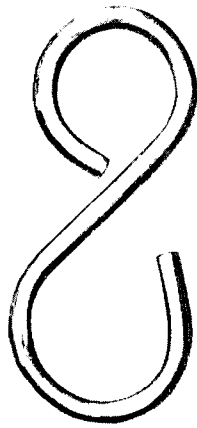


PLATE 21716--FULL SIZE

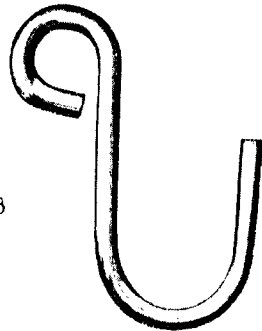
131000



4879



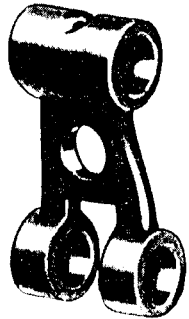
56864



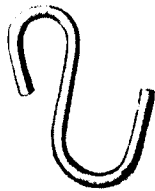
38468



130769



56865

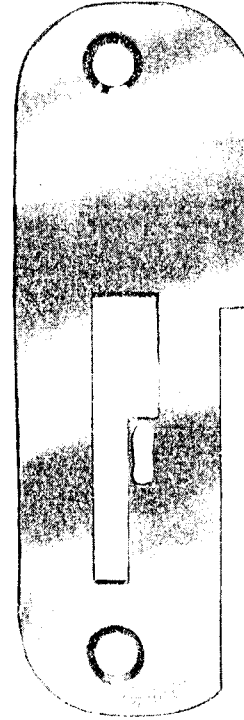


12761

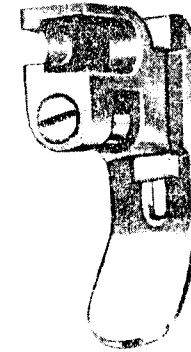


PLATE 21717--FULL SIZE

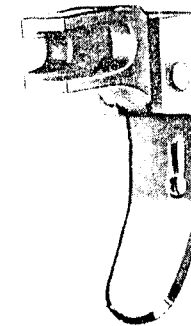
130991



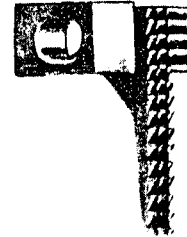
130985



130989



130983



130990

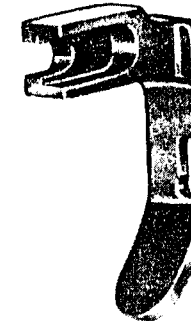


PLATE 21718 - FULL SIZE

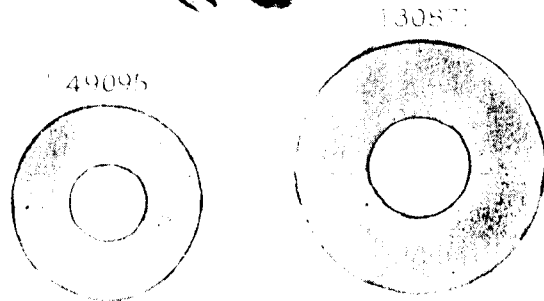
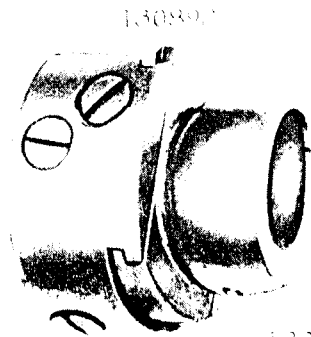
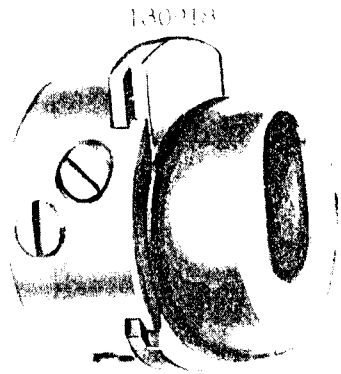
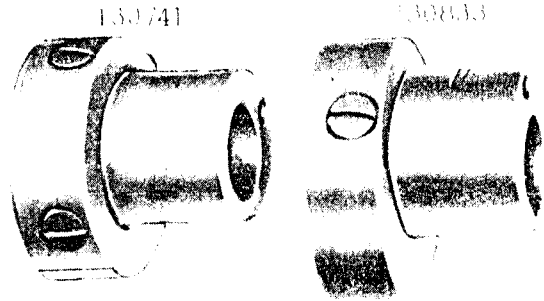


PLATE 21719 - FULL SIZE

130866 130968 130906 130901

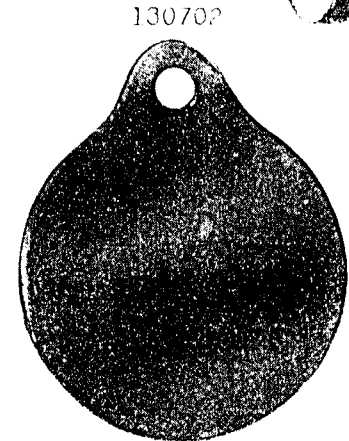
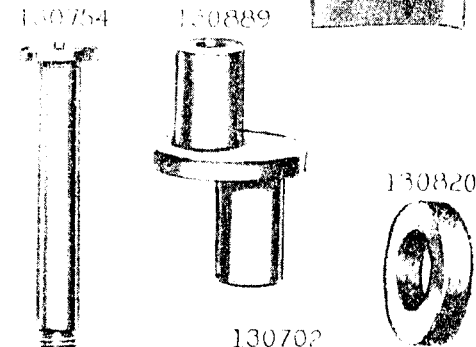
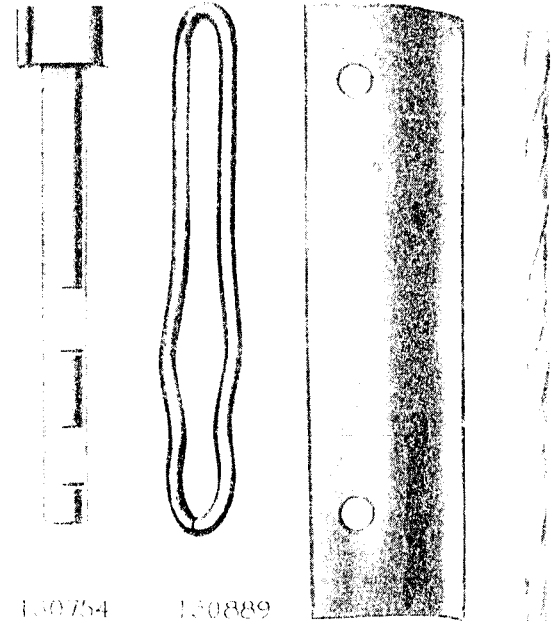


PLATE 21720—FULL SIZE

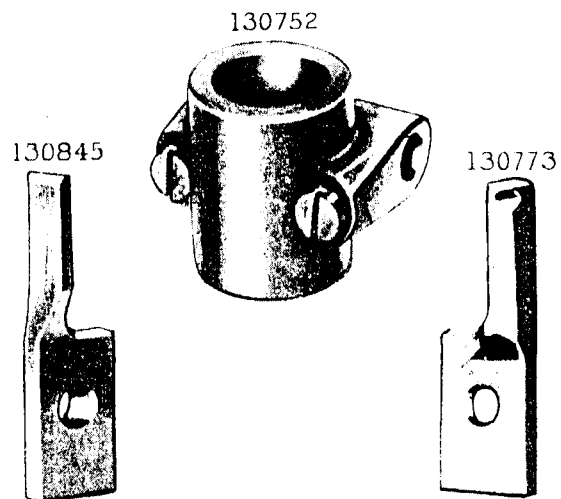
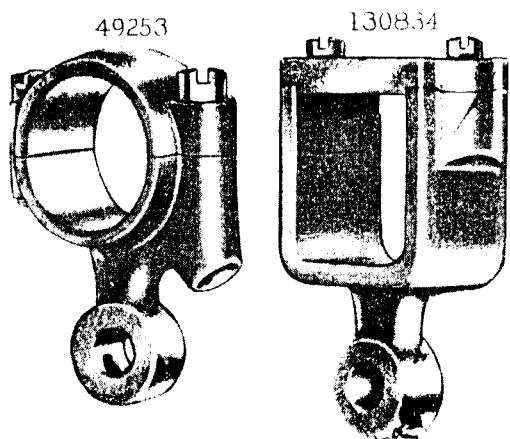
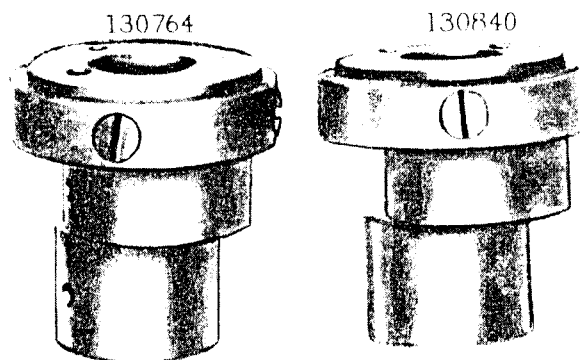


PLATE 21721—FULL SIZE

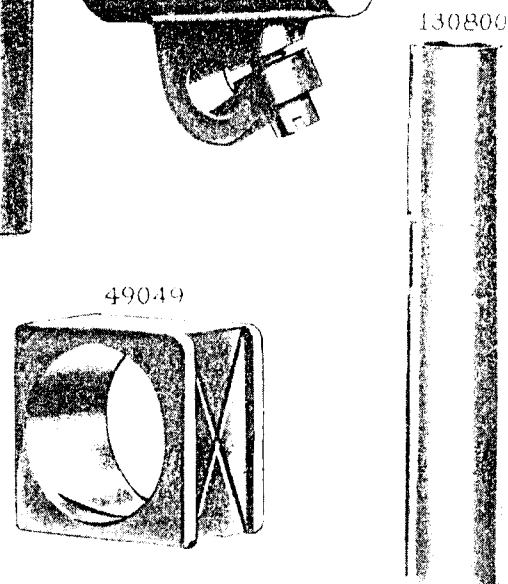
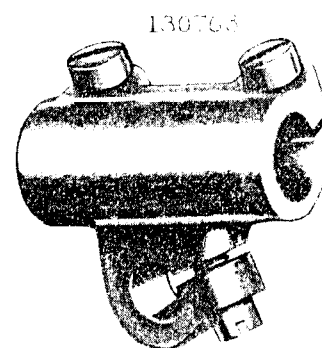
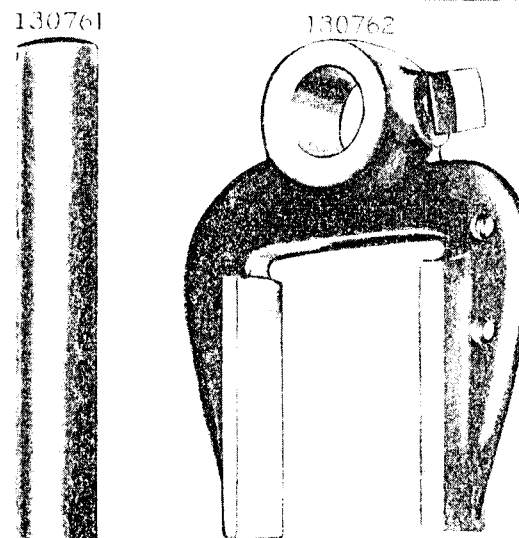


PLATE 21722—FULL SIZE

130822



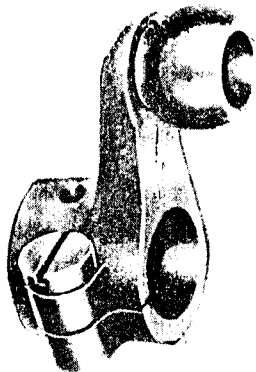
130738



130828



130876

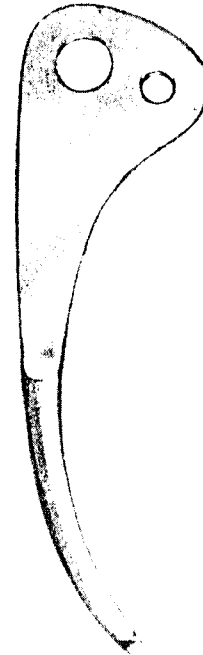


130757



PLATE 21723—FULL SIZE

49062



49066



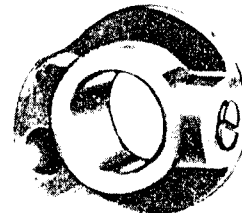
130959



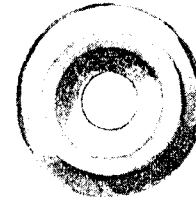
46224



130808



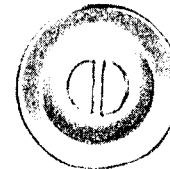
2102



49064



52572



59537



130812



130814



130854



15770



PLATE 21724—FULL SIZE

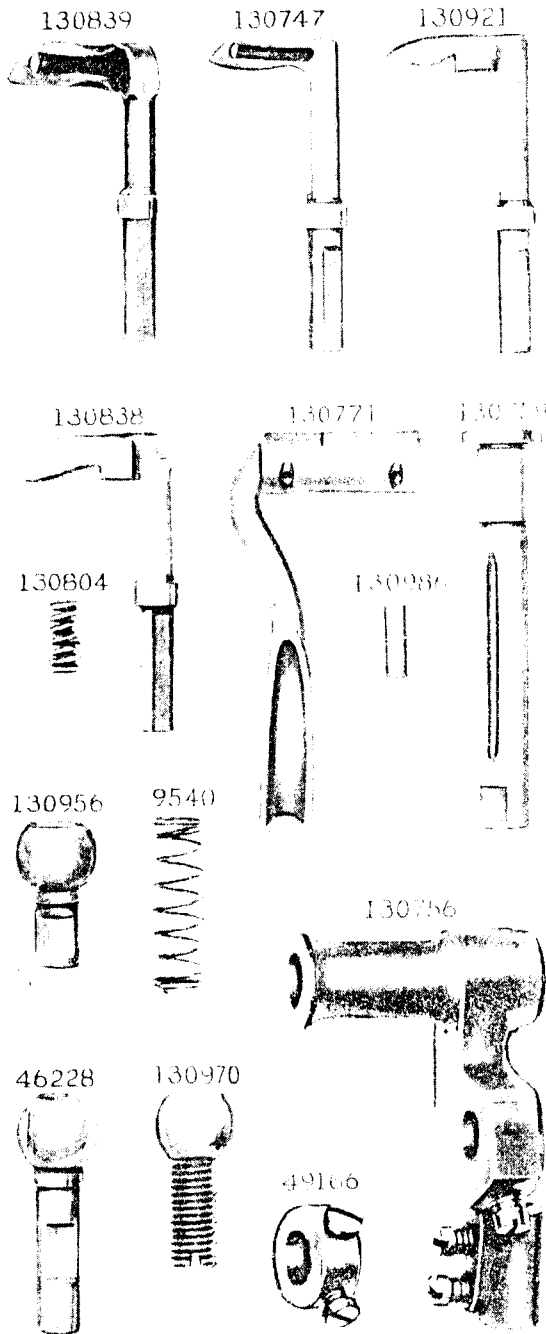


PLATE 21725—FULL SIZE

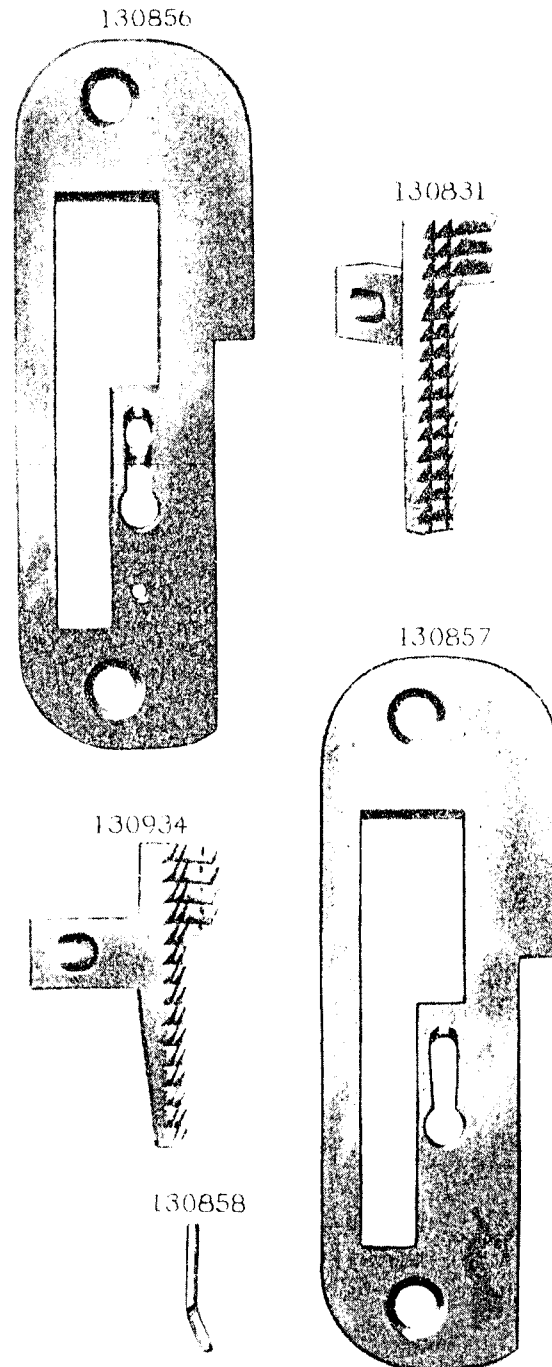
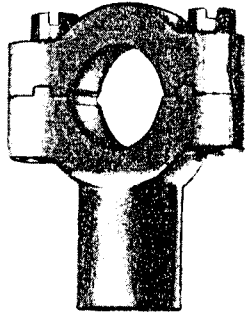


PLATE 21726—FULL SIZE

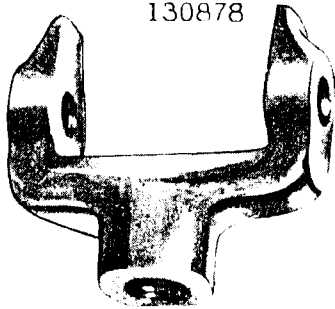
130877

38419

130881



130878



49016



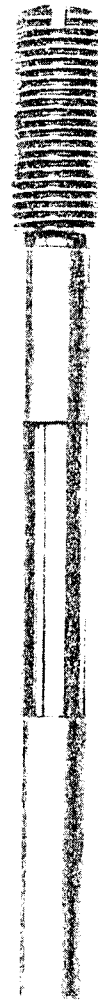
PLATE 21727—FULL SIZE

11398

130755

130843

130768

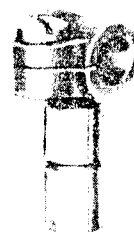


130767

130842

49061

49208



130844



130750

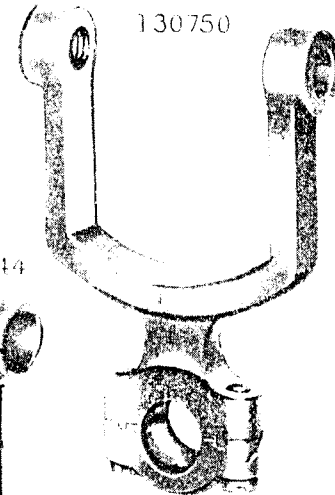
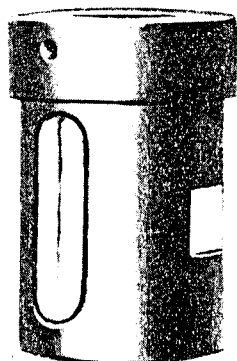


PLATE 21728—FULL SIZE

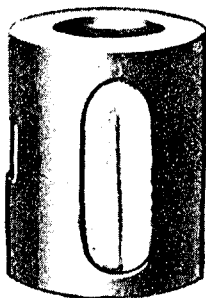
130709



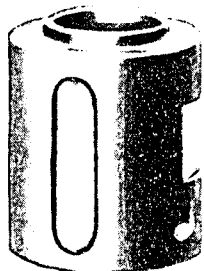
130910



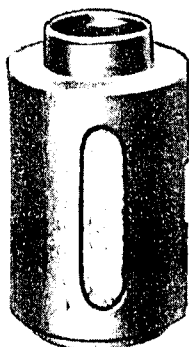
130908



130723



130721

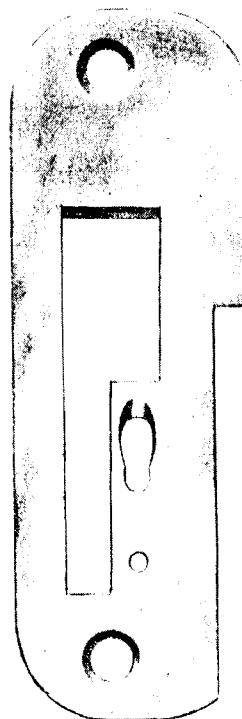


130867



PLATE 21729—FULL SIZE

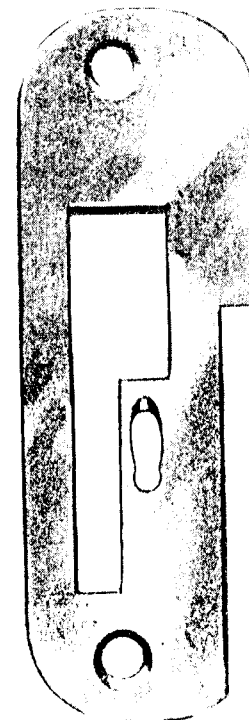
130926



130920



130927



130928



130919

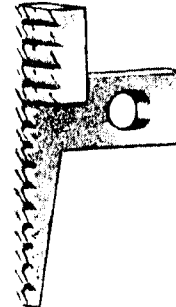


PLATE 21730--FULL SIZE

130797 130795 130794 130793



PLATE 21731--ONE-HALF SIZE

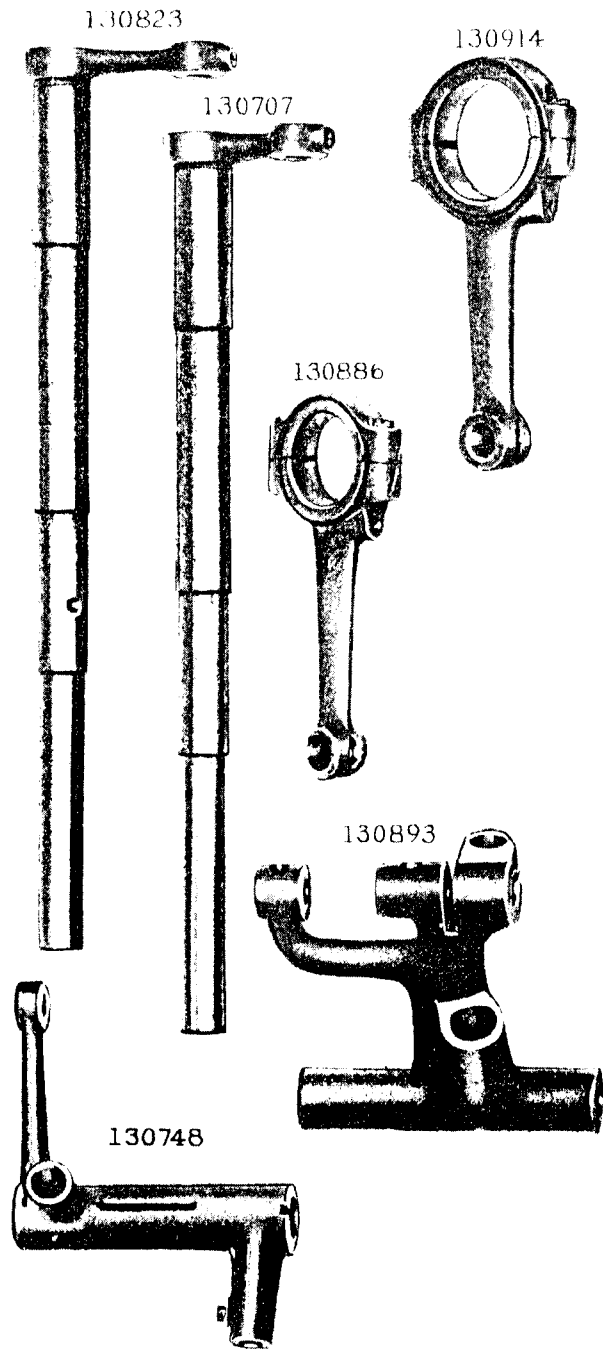
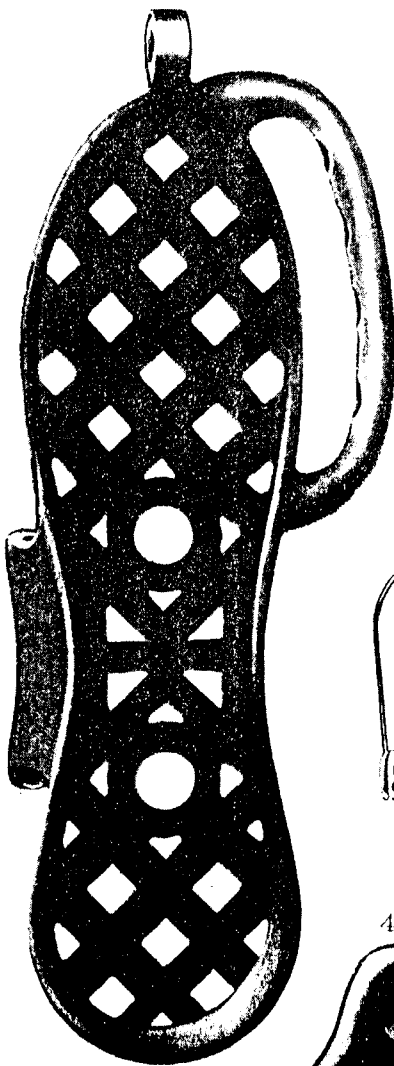


PLATE 21732 ONE-HALF SIZE

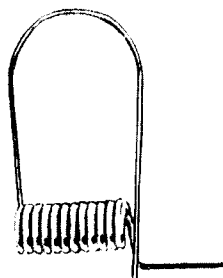
57286



4882



4883



4884

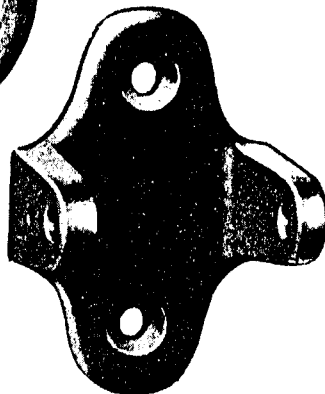
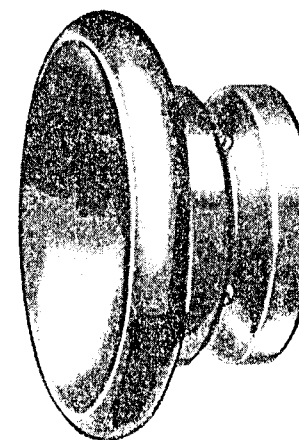
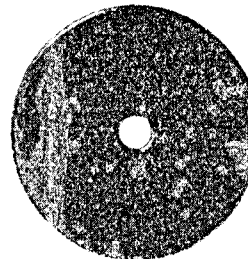


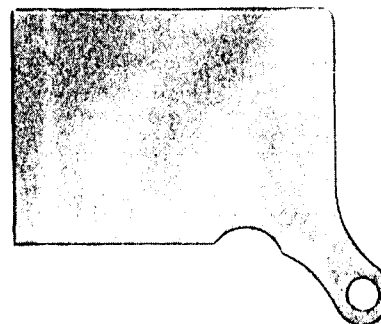
PLATE 21733—ONE-HALF SIZE

130732

130870



130765



130943



130824

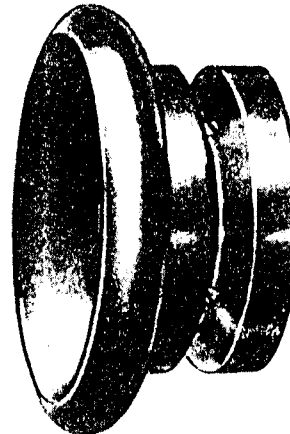
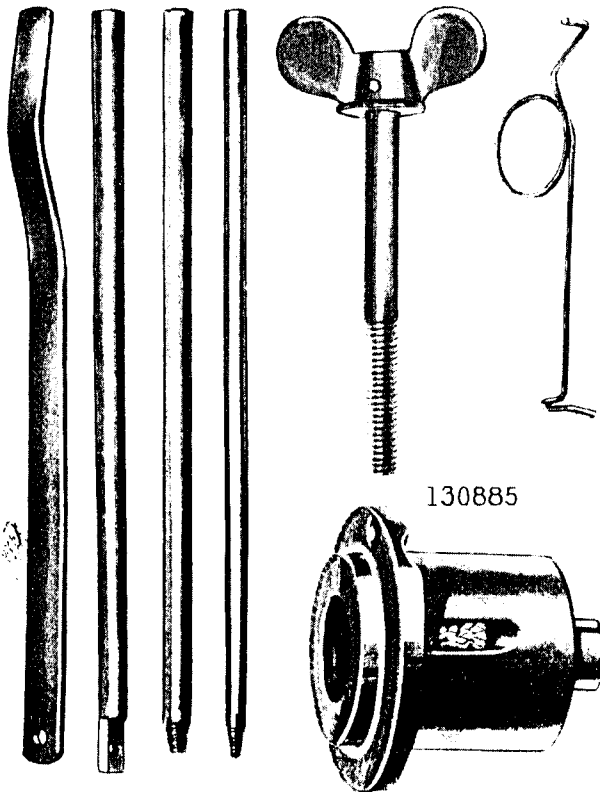


PLATE 21734—ONE-HALF SIZE

49067 130799 130841 130766 50144 130946



130964

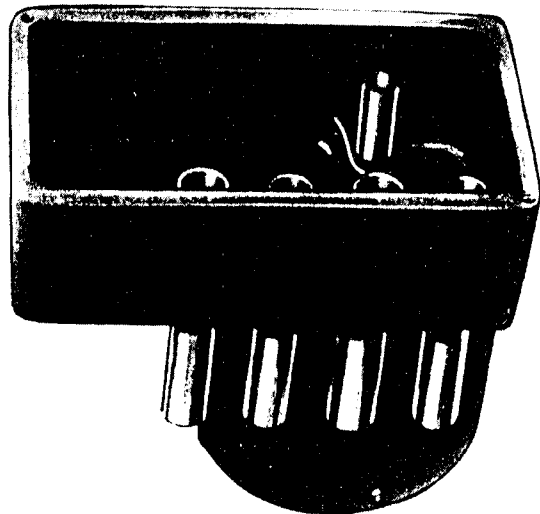


PLATE 21735—ONE-HALF SIZE

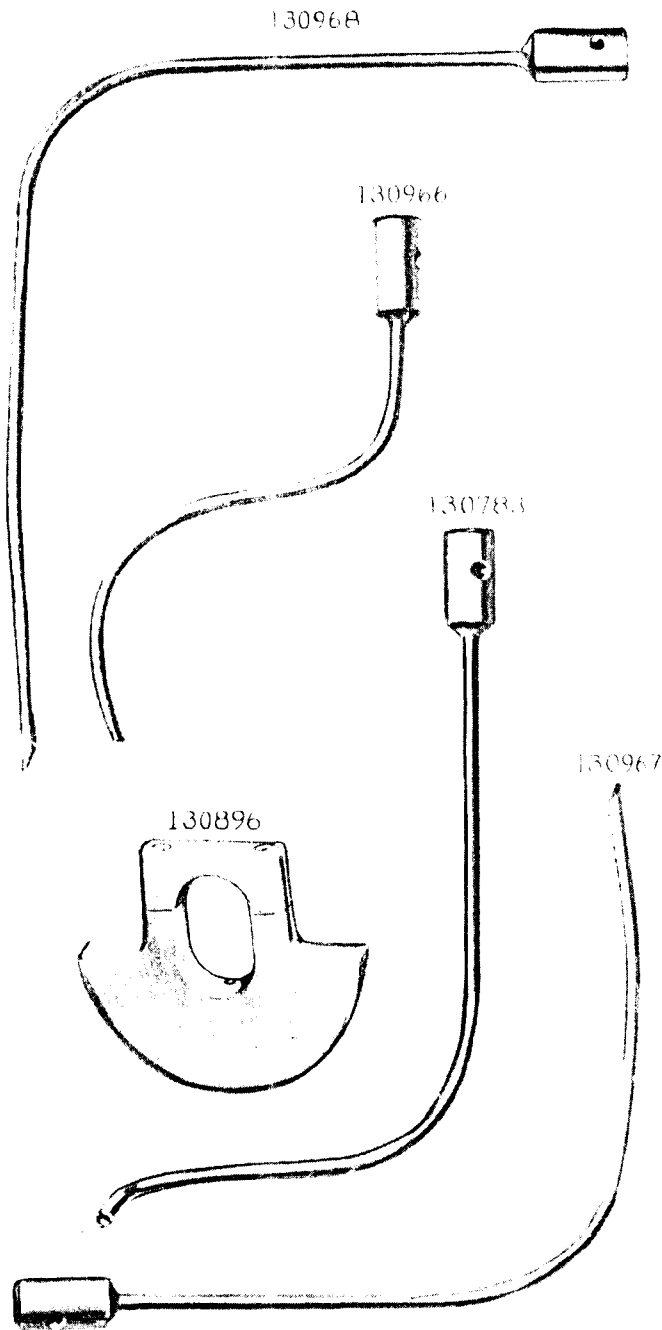
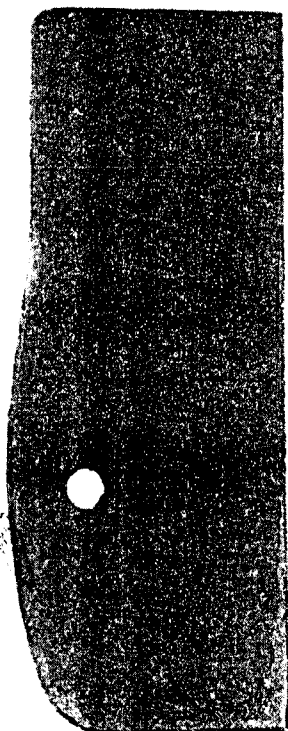
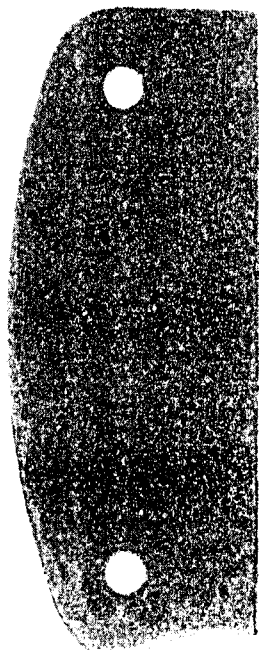


PLATE 21736—ONE-HALF SIZE

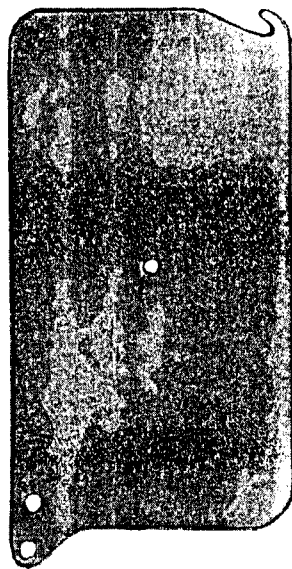
130818



130819



130965



130737

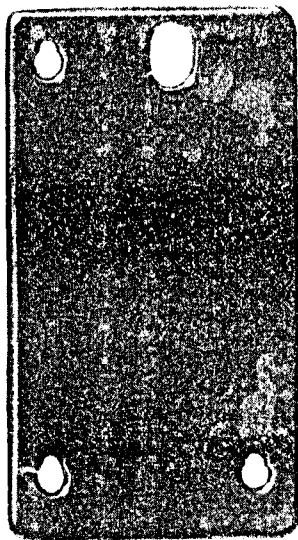
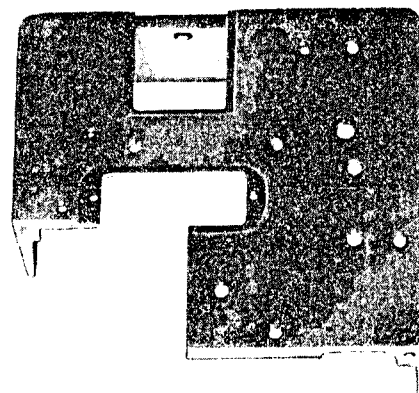
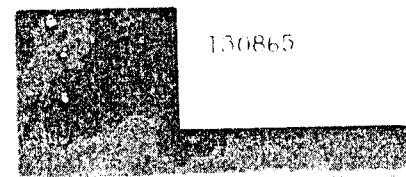


PLATE 21737—ONE-FOURTH SIZE

130733



130865



130756



130960



PLATE 21738—ONE-FOURTH SIZE

130954

