

**SINGER**  
**222K1**

Form K6E34

# Illustrated List of Parts

FOR

## No. 222K1 Machine

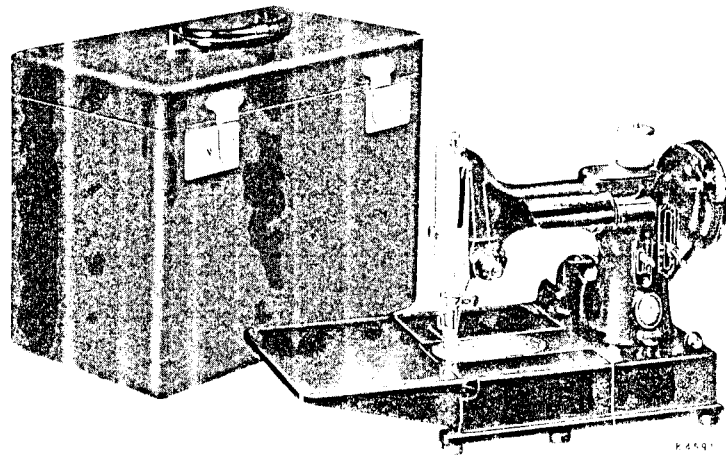

121170

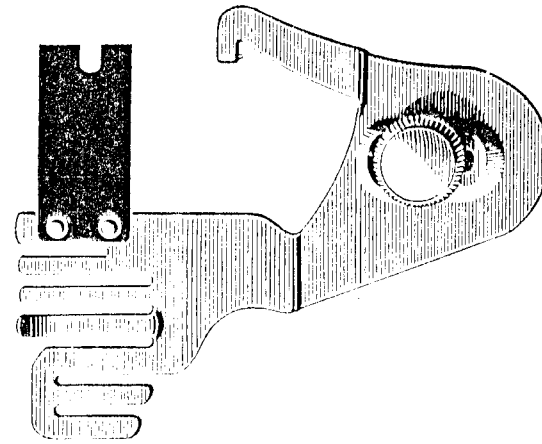

121547

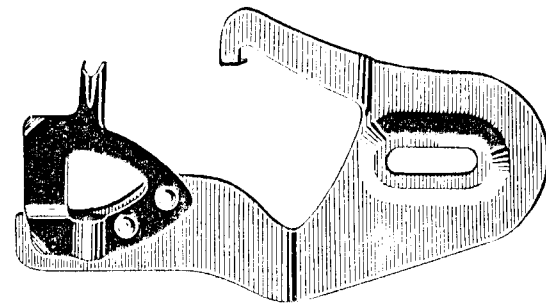

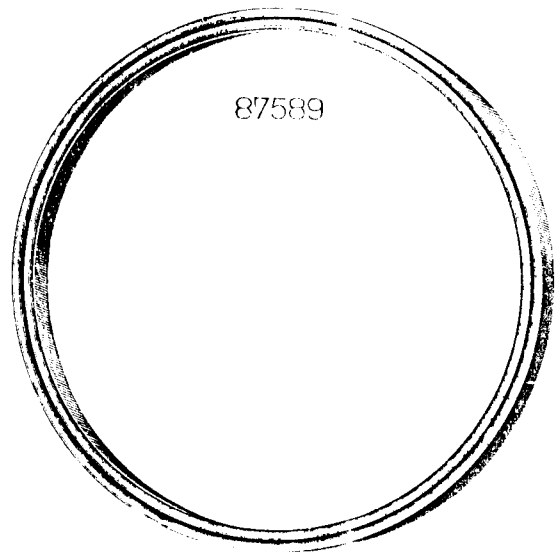

87589

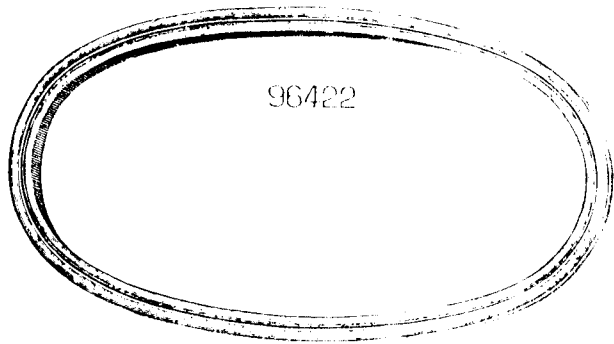

96422

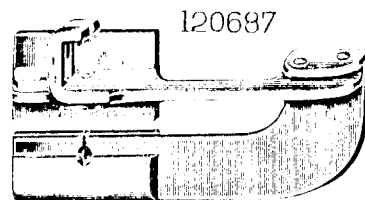

120687

85893

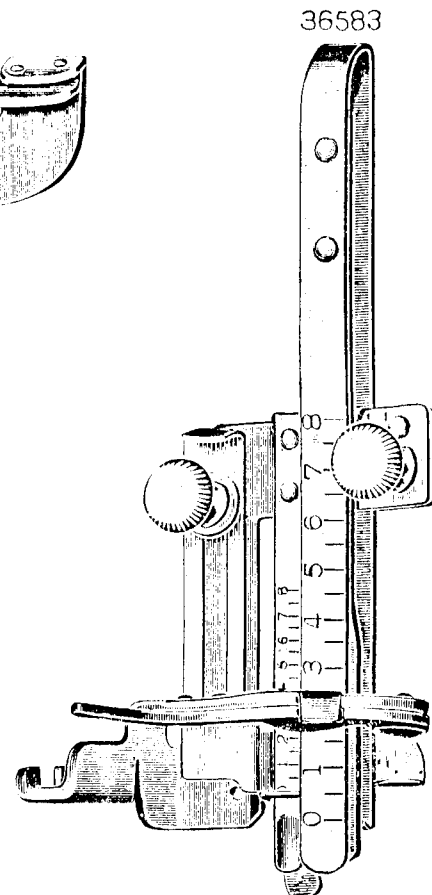

36583

SS528

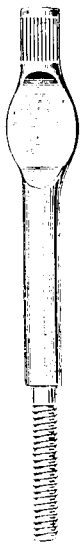

MV95



96425



96426



96844



96427



96845



86642

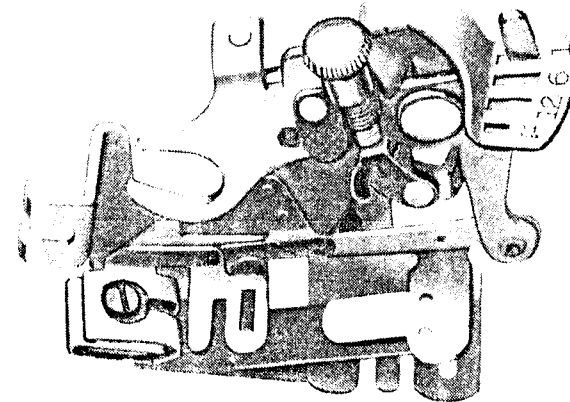

121441

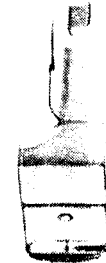

25537

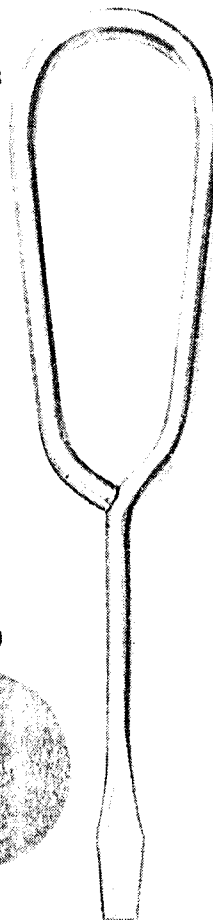

36865

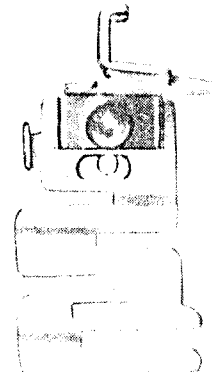

121464

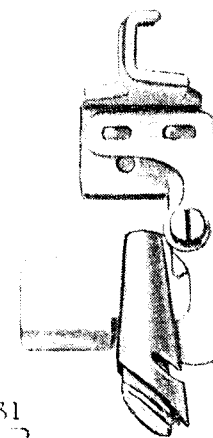

120378



35931

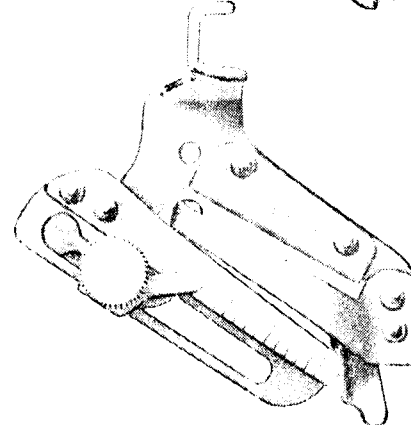

8879

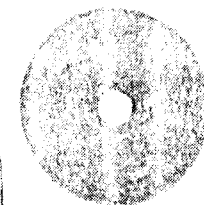

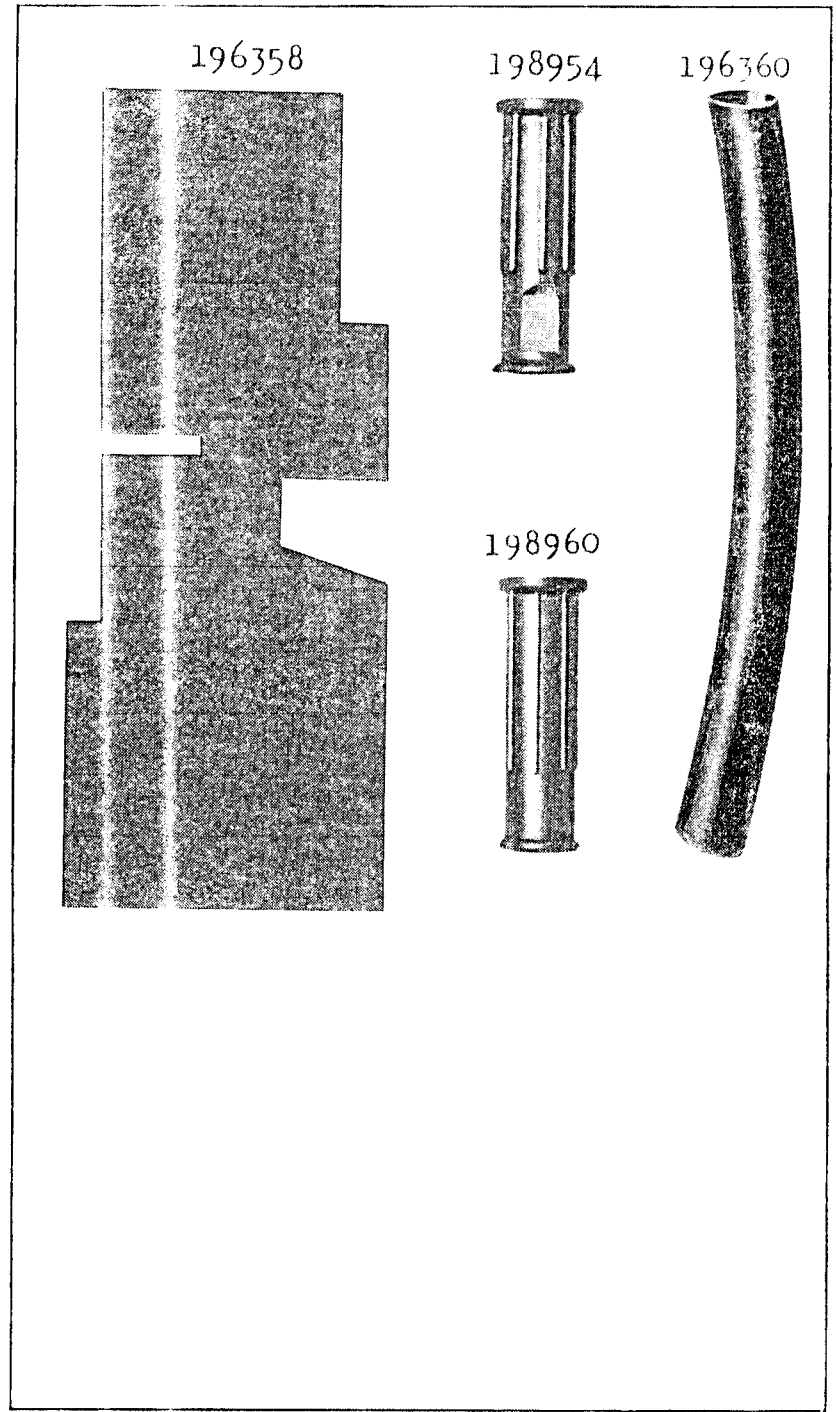
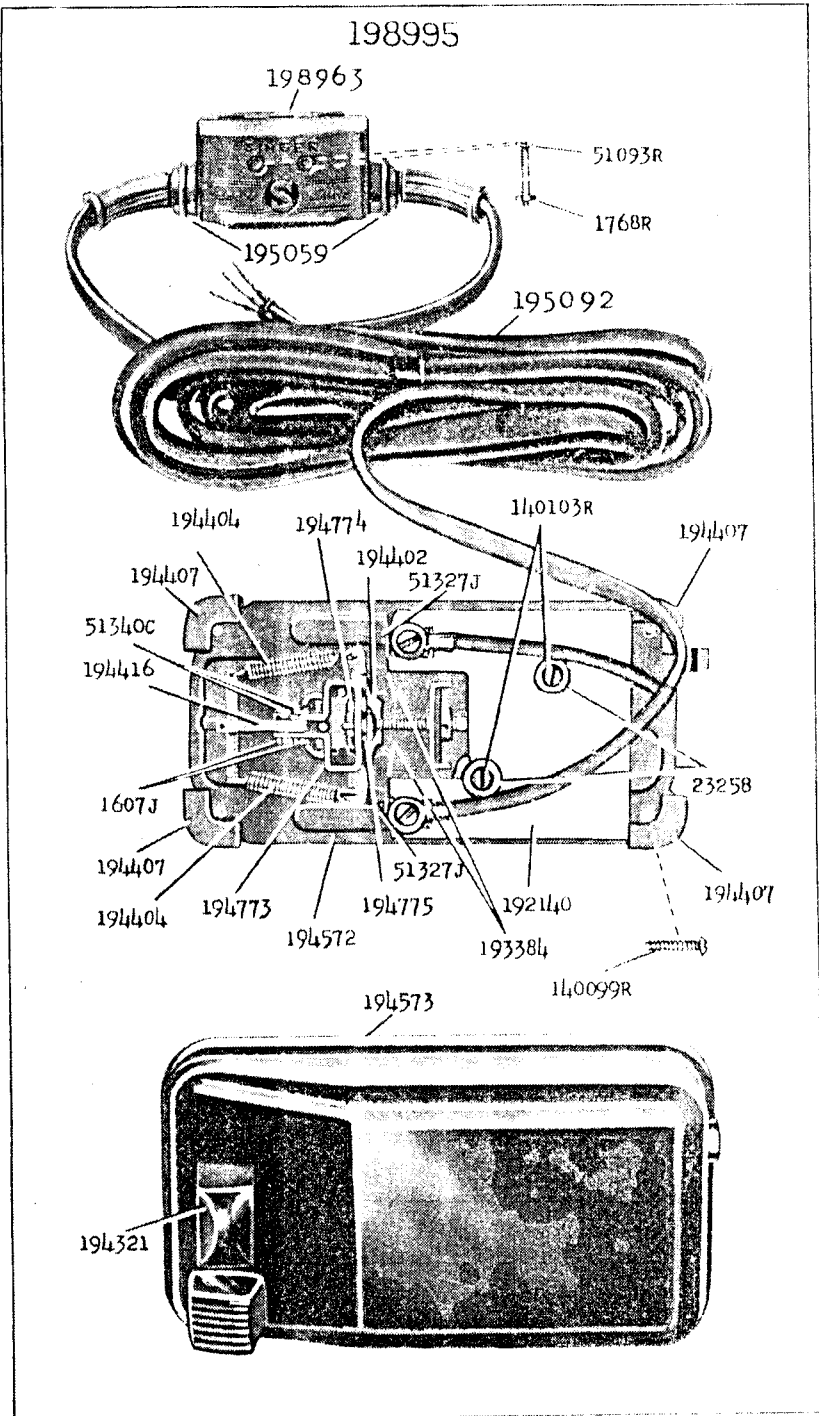

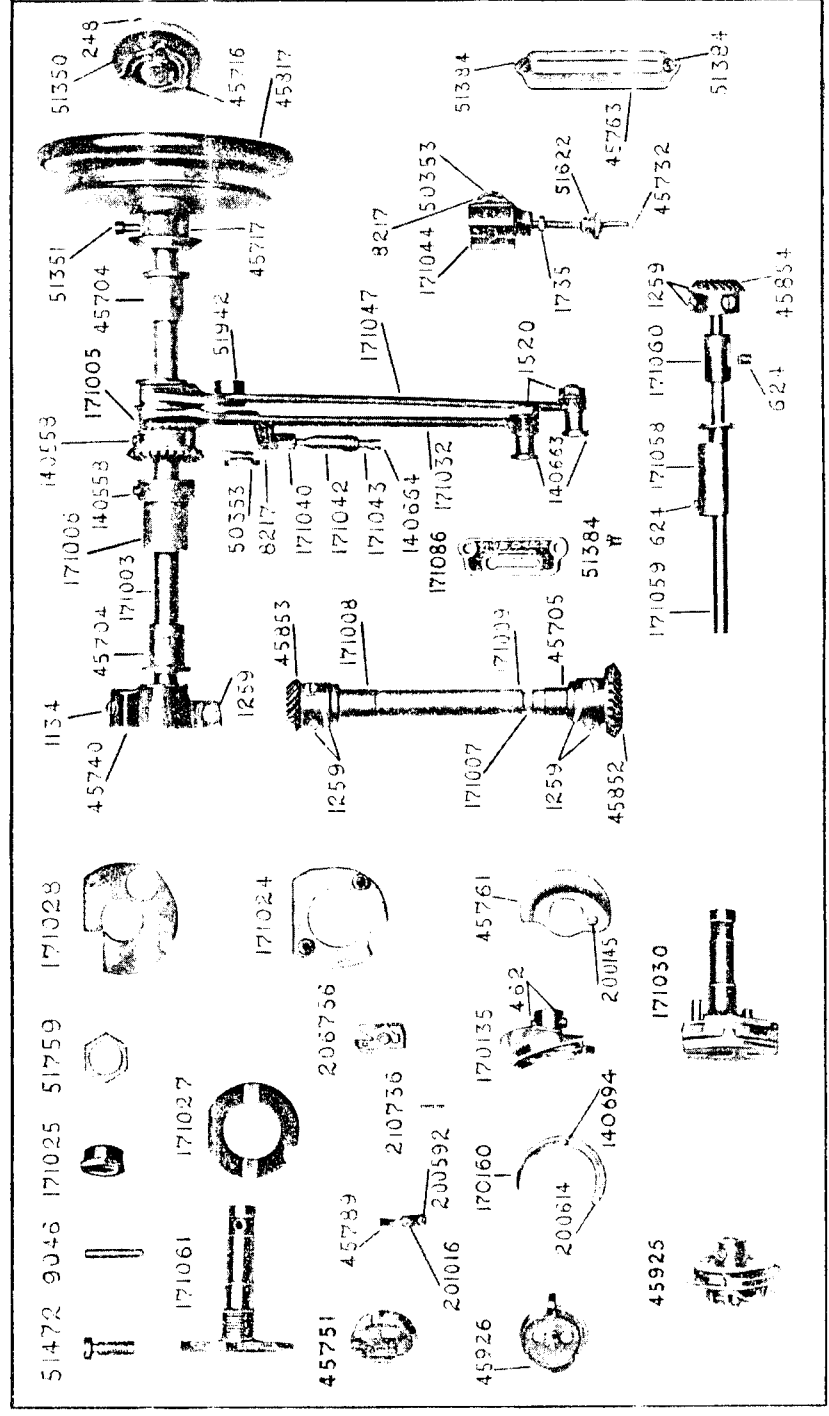
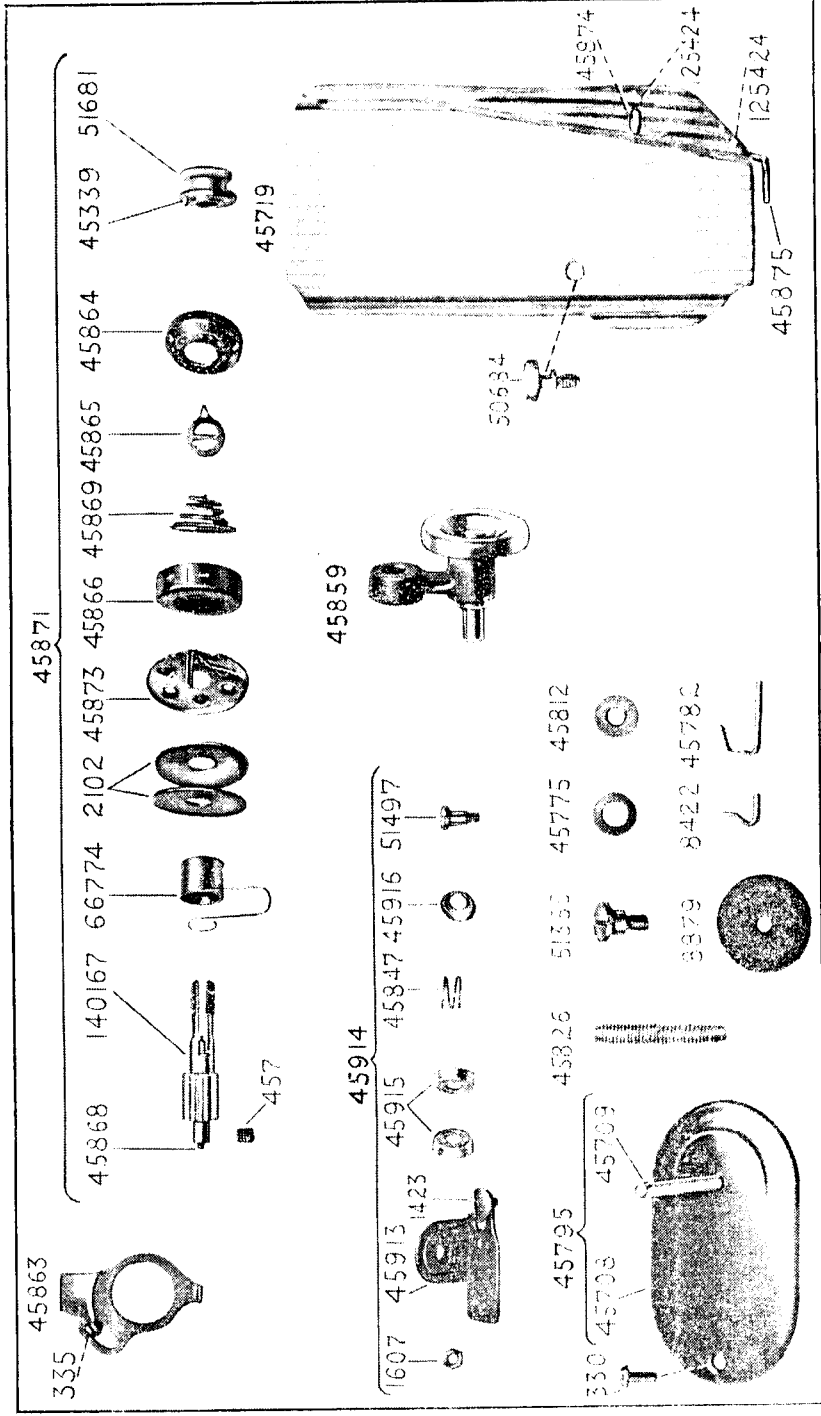

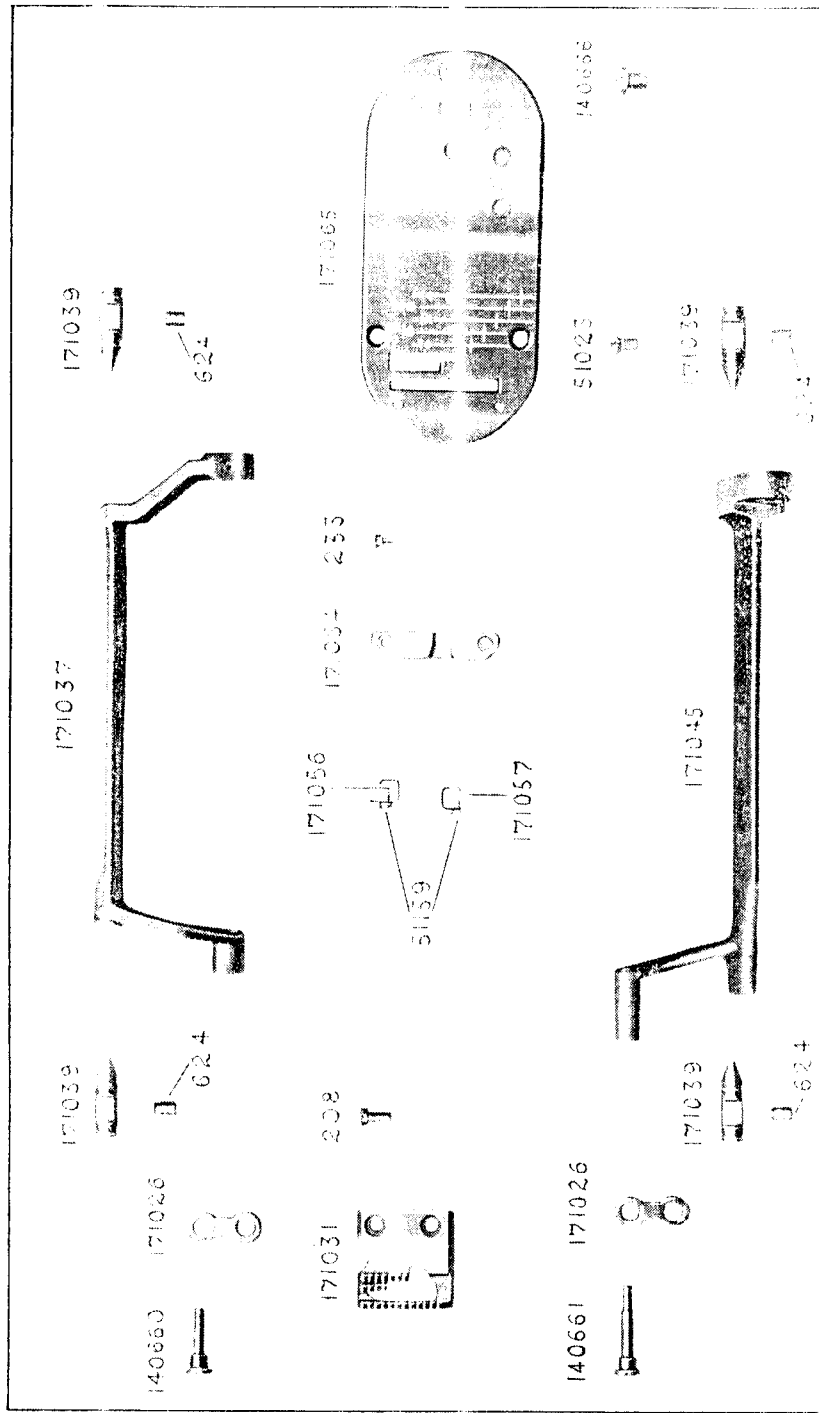
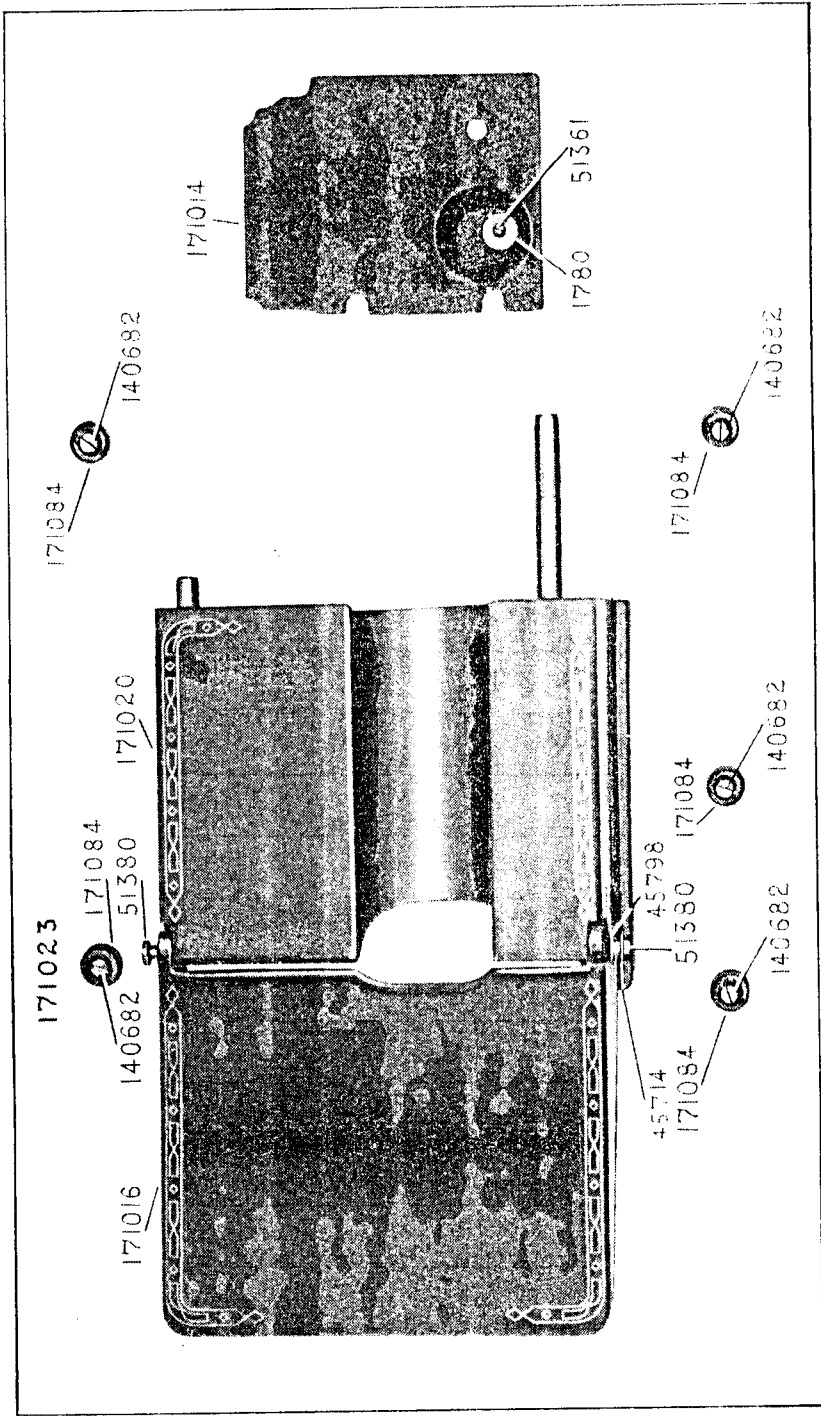

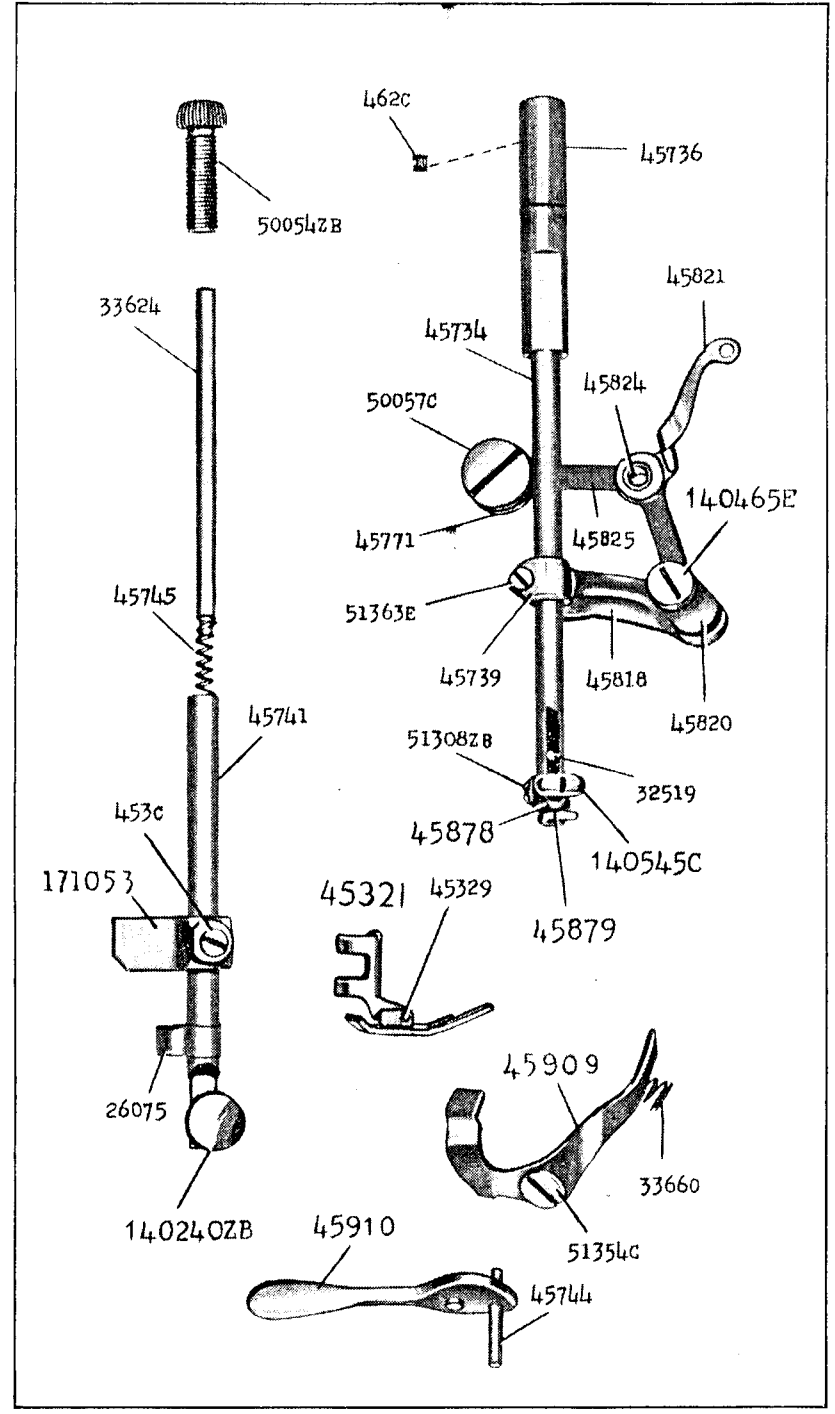
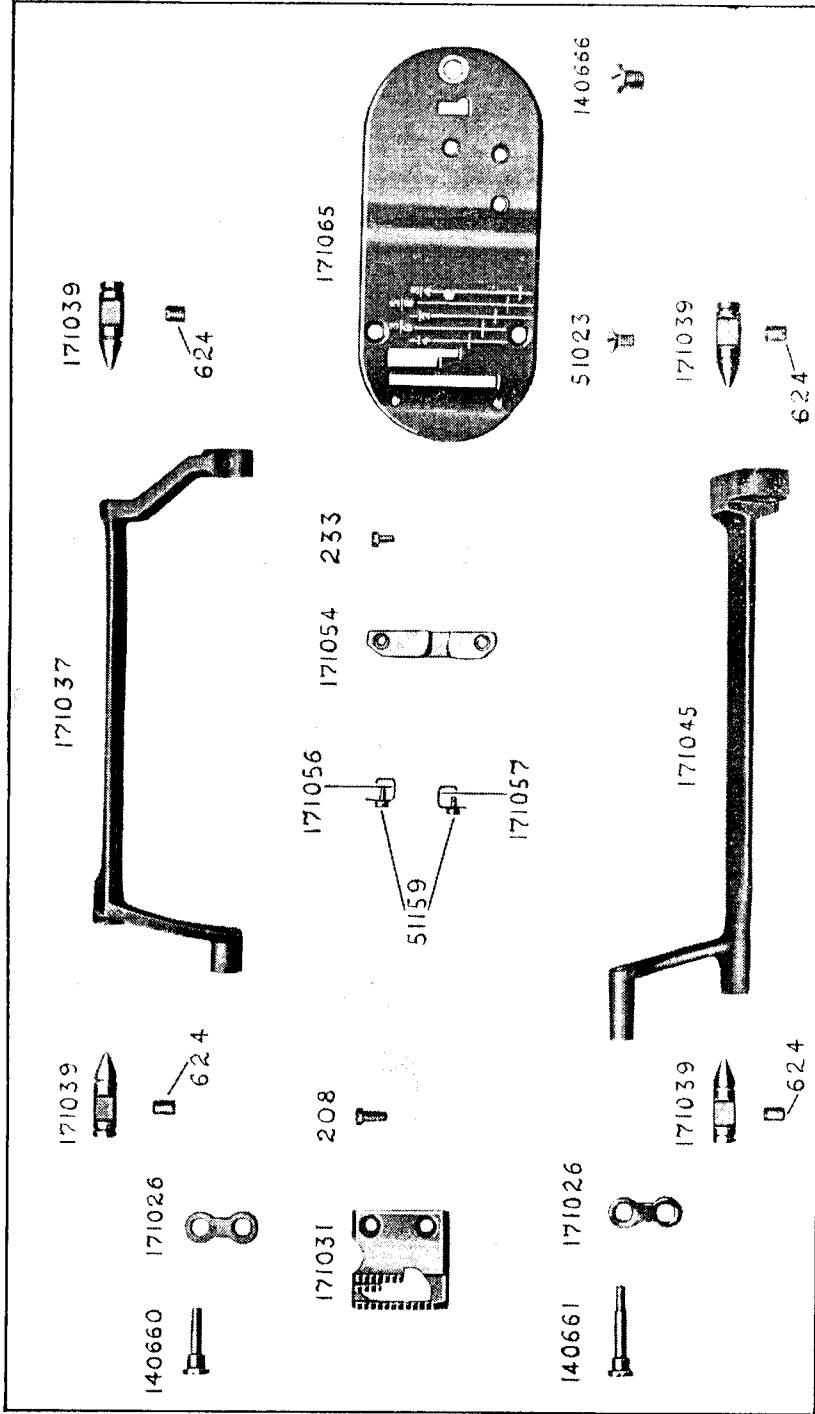



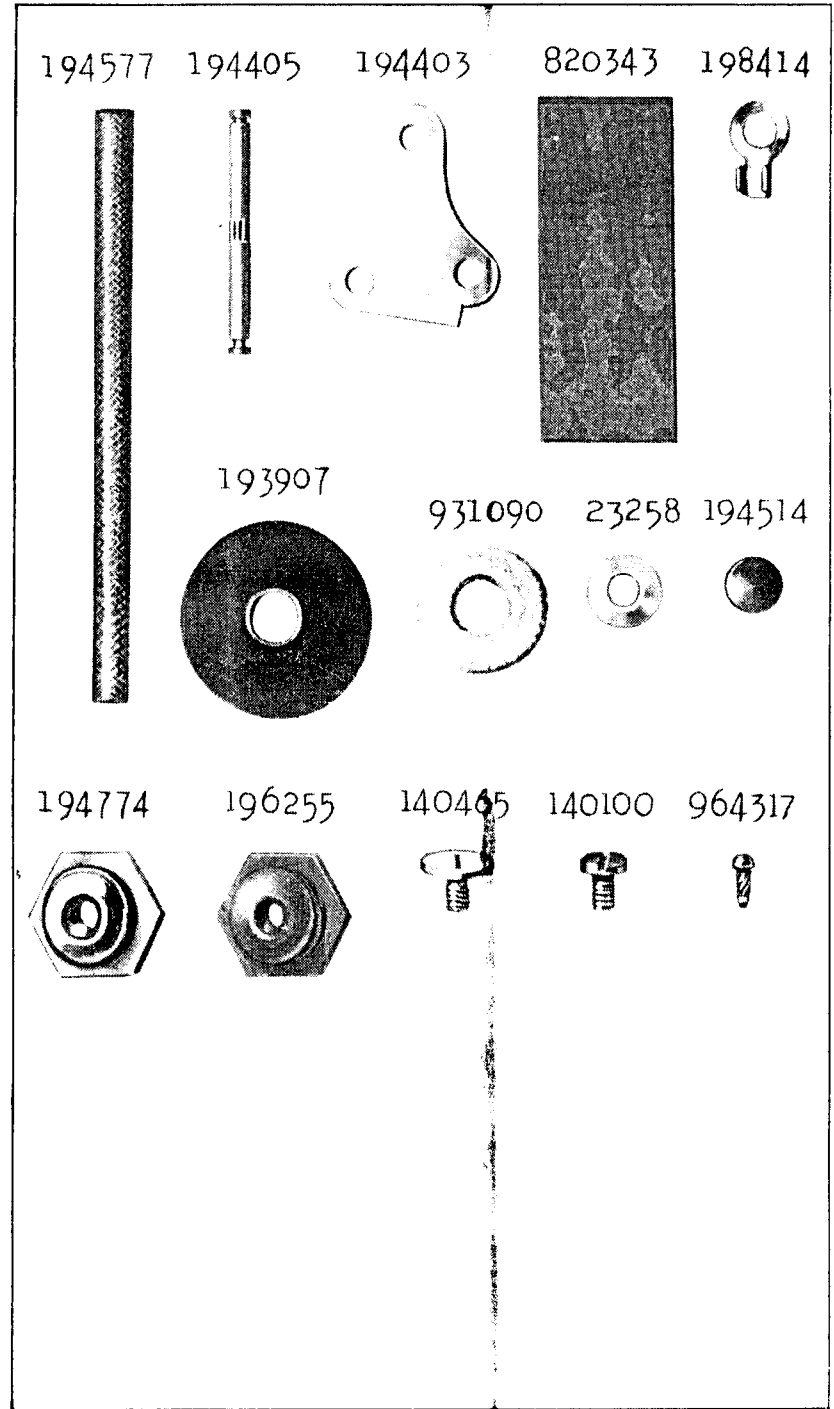
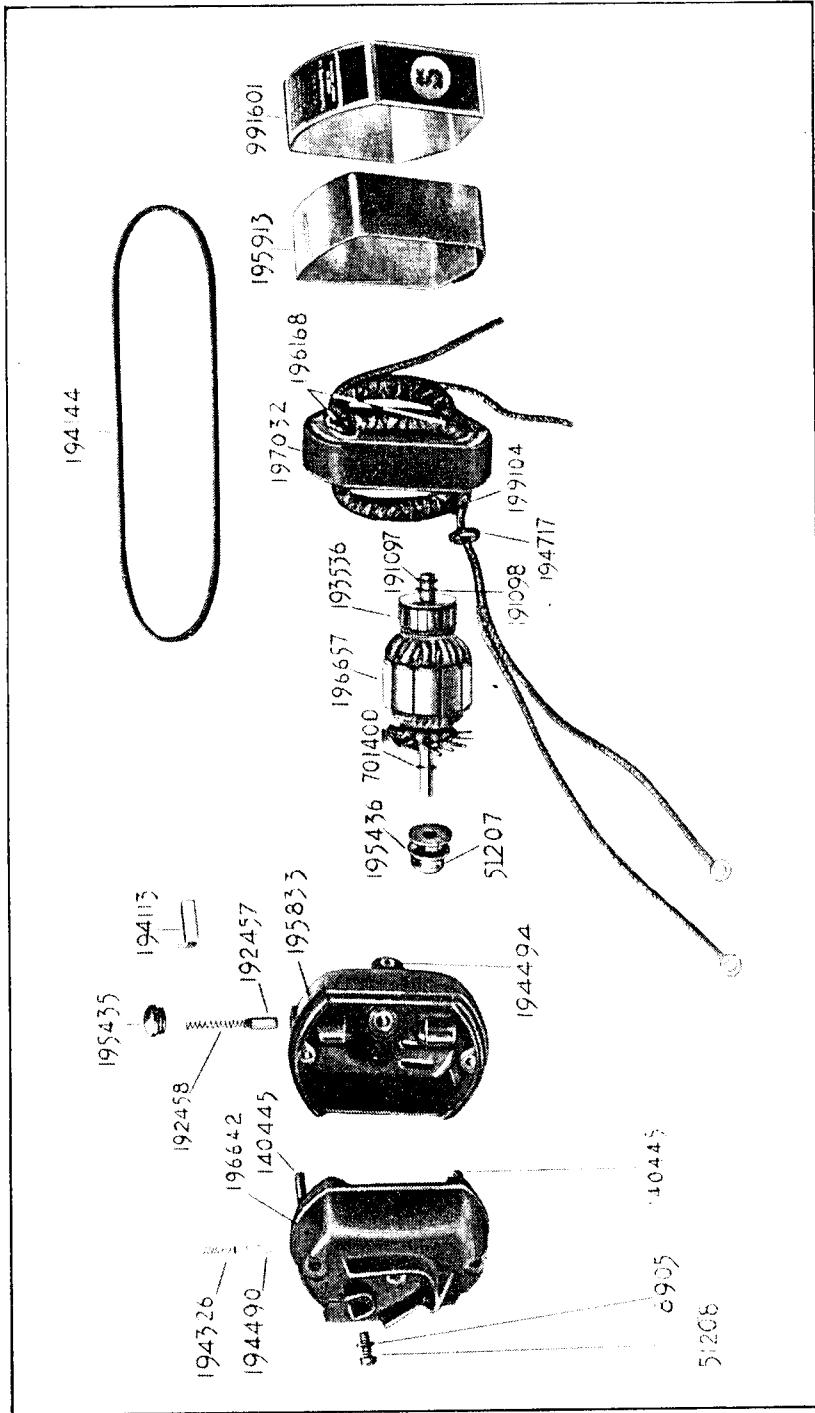

171073

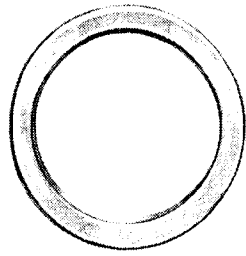

171072

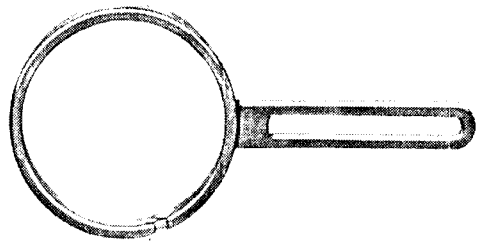

171074

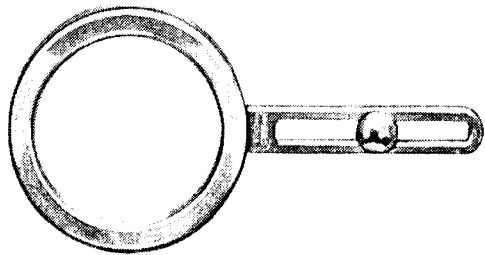

120914



120855

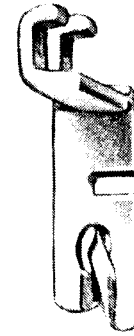

171071

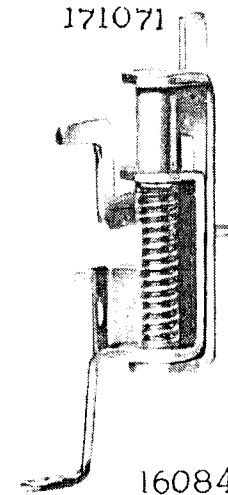

25539

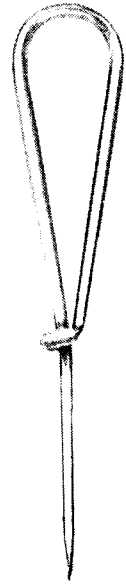

121877

140347

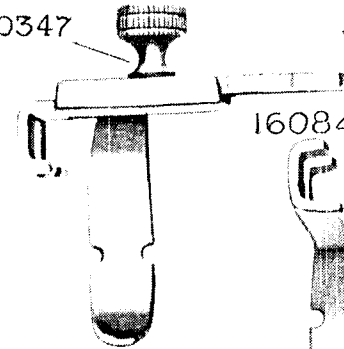

160845

160846



25525

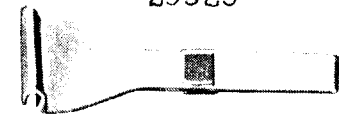

25527

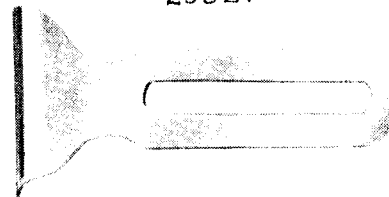

50053



35932

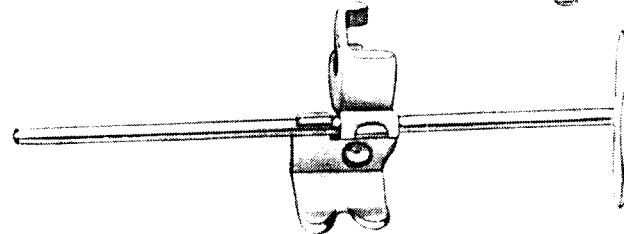

HALF SIZE

199082

196326

194120

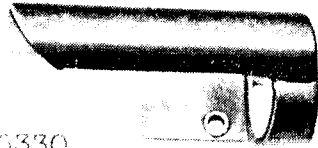

193437



196355



196330



641



199080

199081

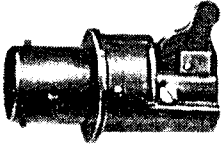

196328



196327

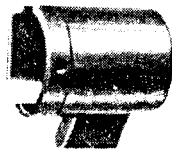

FULL SIZE

193254



193278



193633



51203



193253



193252



193267



50566



193259



193387



193765



194695



51290



194660



193256



193276



51399



51385



194599



193258

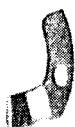

193257



194661



195884



199010

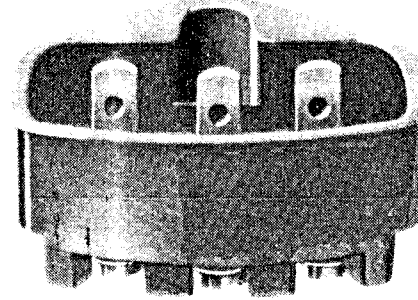

145



198178



701719



198052

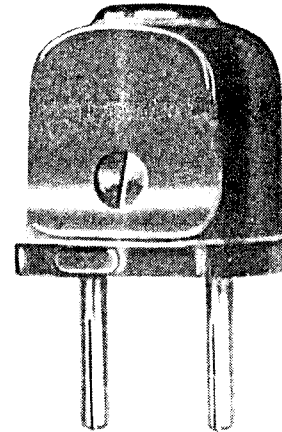

97382

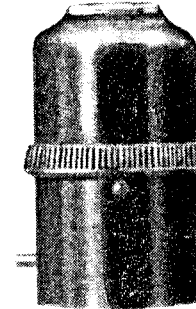

97384

97383

198051



ss541



ss542



704



206



51369



140125



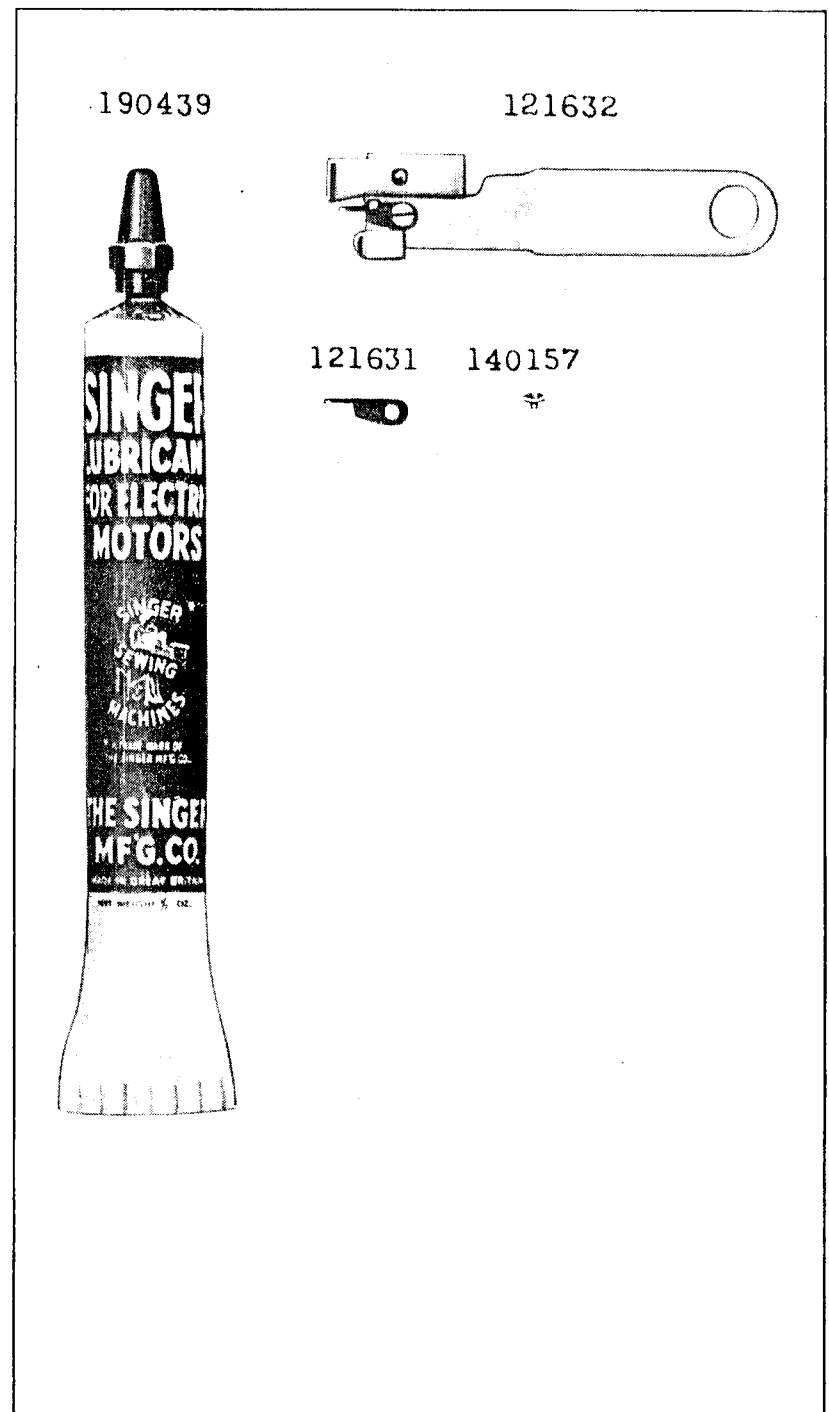
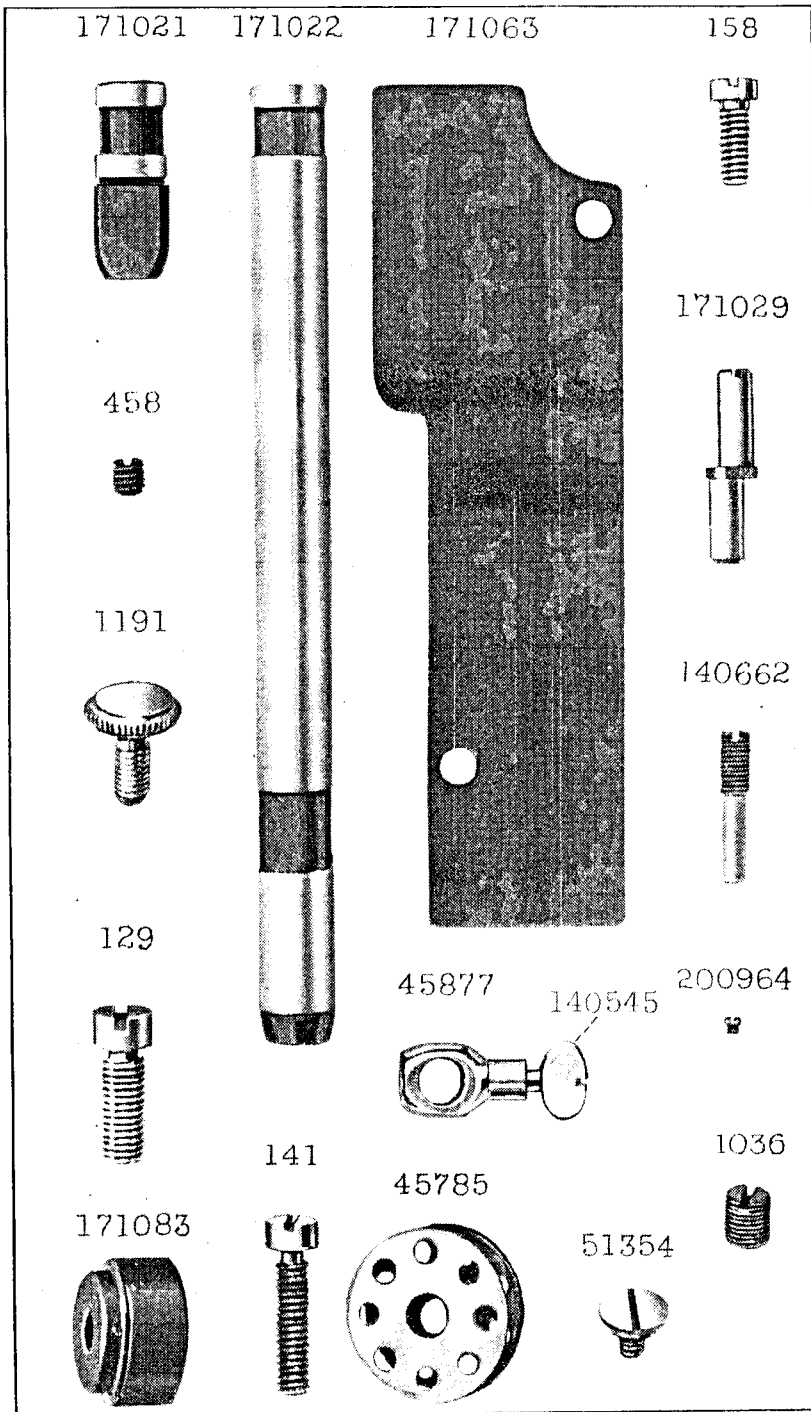

# LIST OF PARTS

FOR

## No. 222K1 MACHINE

### CONTENTS

	Page
Attachments	48
Bobbin Winder Parts	47
Carrying Case	50
Machine Parts	31
Motor Parts	39
Numerical List of Parts	53
SINGER Light	46

# INSTRUCTIONS FOR ORDERING

In ordering from this List, the prefix and affix letters with the part number **MUST BE** quoted exactly as they are shown in the first column.

A number always indicates the same part in whatever List it may appear, or for whatever machine.

The affix letters (where shown) indicate the style of finish, as follows:—

- A. Hardened, Polished, Nickel Plated and Buffed.
- A.A. Buffed and Chromium Plated.
- A.B. Hardened, Polished, Buffed and Chromium Plated.
- A.C. Brown Baking Enamel Finish.
- A.D. Grey Baking Enamel Finish.
- A.E. Hardened, Bright Rumbled and Nickel Plated.
- A.F. Hardened, Bright Rumbled and Nickel Plated, Bright Rumbled and Chromium Plated.
- A.J. Polished, Nickel Plated and Chromium Plated.
- A.K. Hardened, Polished, Nickel Plated and Chromium Plated.
- A.L. Heat Treated for Toughness.
- A.L.D. Heat Treated for Toughness and Polished.
- A.L.X. Heat Treated for Toughness and Black Oxide.
- A.M. Beige Synthetic Enamel.
- A.N. Red Synthetic Enamel Finish.
- A.P. Blue Synthetic Enamel Finish.
- A.P.P. Grey Wrinkle Finish.
- A.R. Beige Wrinkle Finish.
- A.S. Black Moulded Phenolic.
- A.T. Beige Moulded Phenolic.
- A.U. Brown Moulded Phenolic.
- A.V. Black Synthetic Enamel.
- A.X. Grey Dipping Enamel.
- B. Polished, Nickel Plated and Buffed.
- C. Hardened only.
- C.R. Hardened and Phosphoric Treated.
- D. Polished only.
- E. Soft, not Polished.
- F. Hardened and Polished.
- F.J. Hardened, Polished and Nickel Plated.
- G. Bright Rumbled and Nickel Plated.
- H. Blued.
- J. Nickel Plated only.
- K. Hardened and Nickel Plated.
- L. Brass Plated.
- M. Oxidized.
- N. Japanned, Dull.
- P. Japanned, Bright.
- P.P. Wrinkle Finish.
- R. Phosphoric Treated.
- S. Cadmium Plated.
- T. Copper Plated.
- T.A. Hardened, Polished, Copper and Nickel Plated and Buffed.
- T.B. Copper and Nickel Plated and Polished.
- T.J. Copper and Nickel Plated only.
- T.K. Hardened, Copper and Nickel Plated.
- T.L. Copper and Brass Plated.
- T.M. Copper Plated and Oxidized.
- U. Zinc Plated.
- V. Silver Plated.
- W. Polished and Nickel Plated.
- X. Black Oxide for Iron and Steel.
- X.C. Hardened and Black Oxide for Iron and Steel.
- Y. Black Nickel Plated only.
- Z. Chromium Plated.
- Z.A. Hardened, Polished, Nickel Plated, Buffed and Chromium Plated.
- Z.B. Polished, Nickel Plated, Buffed and Chromium Plated.
- Z.C. Hardened and Chromium Plated.
- Z.D. Polished and Chromium Plated.
- Z.G. Bright Rumbled, Nickel Plated, Bright Rumbled and Chromium Plated.
- Z.J. Nickel and Chromium Plated.
- Z.T. Copper and Chromium Plated.

Parts marked with an asterisk (\*) are furnished only when the repairs are made at Factory.

## PARTS COMPLETE

FOR

## MACHINE No. 222K1

Portable Family Machine, Reversible Drop Feed, Rotary Hook,  
Motor Driven and SINGER Light.

Can be used for Tubular work by removing the Cloth Plate and Extension Plate Assembly.

No.	Plate				
*171001		Arm	...	...	...
*171002		"	171001 with 171007, 171008, 171009 and two 45704	...	...
<i>NOTE. Due to the accuracy required for gear alignment, Arm cannot be supplied separately and can only be sent as a unit. Arm and Bed assembled.</i>					
9046	2670	Arm Dowel Pin (2)	...	...	...
51472e	2670	" Screw (3)	...	...	...
171003	2670	" Shaft (horizontal)	...	...	...
171004	"	" " ( " )	171003 with 45740	...	...
171005	2670	" " ( " )	Bevel Gear Feed Cam and Feed Lifting Eccentric with 140558al	...	...
140558al	2670	" " ( " )	Bevel Gear Feed Cam and Feed Lifting Eccentric Set Screw	...	...
45704	2670	" " ( " )	Bushing (2)	...	...
171006	2670	" " ( " )	Counterbalance with 140558c	...	...
140558c	2670	" " ( " )	" Set Screw	...	...
45705	2670	" " (upright)	...	...	...
45852	2670	" " ( " )	Bevel Gear (lower) with two 1259al	...	...
1259al	2670	" " ( " )	" " ( " ) Set Screw	...	...
45853	2670	" " ( " )	" " (upper) with two 1259al	...	...
1259al	2670	" " ( " )	" " ( " ) Set Screw	...	...
171007	2670	" " ( " )	Bushing (lower)	...	...
171008	2670	" " ( " )	" (upper)	...	...
171009	2670	" " ( " )	Lamp Lead Shield	...	...
45708	2669	" Top Cover	...	...	...
45795	2669	" " " 45708 with 45709	...	...	...
330x	2669	" " " Screw	...	...	...
45709	2669	" " " Spool Pin	...	...	...
8879	2669	" " " " " Washer (cloth) (packed with Attachments)	...	...	...
*171010		Bed	...	...	...
*171011		"	171010 with 171017, 171018, 171060, two each 129x, 624al, 171083, four each 140682e and 171084	...	...
<i>NOTE. Due to the accuracy required for gear alignment, Bed cannot be supplied separately and can only be sent as a unit. Arm and Bed assembled.</i>					
171012		Bed Cover (tubular)	...	...	...
141r	2681	" " ( " )	Screw	...	...



No.	Plate				
171039	2672	<b>Feed Rock Shaft Centre (right)</b> ... ..			
624al	2672	" " " " ( " ) Set Screw ... ..			
171047	2670	" " " " Forked Connection ... ..			
171048	-	" " " " " " 171047 with 51942 ... ..			
140663c	2670	" " " " " " Hinge Screw (eccentric) ... ..			
1520e	2670	" " " " " " " " Nut ... ..			
51941	-	" " " " " " " " Roller ... ..			
51942	2670	" " " " " " " " 51941 with 140665e ... ..			
140665e	-	" " " " " " " " Stud ... ..			
171040	2670	" " " " " " " " Throw-out Lever ... ..			
50353e	2670	" " " " " " " " Hinge Screw ... ..			
8217	2670	" " " " " " " " Friction Washer ... ..			
171086	2670	" " " " " " " " Plate ... ..			
51384zb	2670	" " " " " " " " Screw (2) ... ..			
171042	2670	" " " " " " " " Positioning Sleeve ... ..			
140664zb	2670	" " " " " " " " Screw ... ..			
171043	2670	" " " " " " " " Spring ... ..			
45817	2670	<b>Hand Wheel</b> ... ..			
171050	2673	<b>Lamp Lead Shield (Underside of Bed)</b> ... ..			
171051	2673	" " " " " " (Side of Arm) ... ..			
206x	2680	" " " " " " ( " " " ) Screw ... ..			
45734	2674	<b>Needle Bar (hollow) with 32519</b> ... ..			
45736	2674	" " " " " " Bushing (upper) ... ..			
462al	2674	" " " " " " ( " ) Set Screw ... ..			
45818	2674	" " " " " " " " Connecting Link ... ..			
45819	-	" " " " " " " " 45818 with 45739 ... ..			
45739	2674	" " " " " " " " Stud with 51363e ... ..			
51363e	2674	" " " " " " " " Clamping Screw ... ..			
45740	2670	" " " " " " " " Crank with 1036al and 1134al ... ..			
1134al	2670	" " " " " " " " Position Screw ... ..			
45877	2681	" " " " " " " " Clamp Body with 140545ze ... ..			
45878	2674	" " " " " " " " 45877 with 51308zj ... ..			
45879	2674	" " " " " " " " Gib and Thread Guard ... ..			
51308zj	2674	" " " " " " " " Position Screw ... ..			
140545ze	2681	" " " " " " " " Thumb Screw ... ..			
32519	2674	" " " " " " " " Stop Pin ... ..			
45741	2674	<b>Presser Bar (hollow)</b> ... ..			
171053	2674	" " " " " " " " Guide Bracket with 453al ... ..			
453al	2674	" " " " " " " " Set Screw ... ..			
45910	2674	" " " " " " " " Lifter ... ..			
45744	2674	" " " " " " " " Hinge Pin ... ..			
45745	2674	" " " " " " " " Spring ... ..			
45813	-	" " " " " " " " 45745 with 33624 ... ..			

No.	Plate				
45329	2674	<b>Presser Foot Hinge Pin</b> ... ..			
*45319	-	" " " " " " Plate ... ..			
*32774	-	" " " " " " Shank ... ..			
45321	2674	<b>Presser Foot (hinged), complete, Nos. 32774, 45319 and 45329</b> ... ..			
140240zb	2674	" " " " " " Thumb Screw ... ..			
50054zb	2674	<b>Pressure Regulating Thumb Screw</b> ... ..			
33624	2674	" " " " " " " " Extension Pin ... ..			
170135	2670	<b>Rotating Hook with two 462al</b> ... ..			
15924	-	" " " " 170135 with 45761, 45926, 140694b, 170160, 200145e and 200614e ... ..			
45925	2670	" " " " (with Yielding Gib) and Bobbin Case, complete, Nos. 45751 and 45924 ... ..			
45785	2681	" " " " " " Bobbin, Nos. 45787 and two 45786 ... ..			
*45750	-	" " " " " " " " Case ... ..			
45751	2670	<b>Rotating Hook Bobbin Case, complete, Nos. 45750, 45789, 200592e, 200964e, 201016f, 206736 and 210736</b> ... ..			
45926	2670	<b>Rotating Hook Bobbin Case Base</b> ... ..			
206735	-	" " " " " " " " Latch ... ..			
206736	2670	" " " " " " " " 206735 with 206731 and 206737 ... ..			
206731	-	" " " " " " " " " " Fulcrum Pin ... ..			
206737	-	" " " " " " " " " " Lever ... ..			
210736	2670	" " " " " " " " " " Spring ... ..			
200964e	2681	" " " " " " " " " " Stop Screw ... ..			
171051	2672	" " " " " " " " " " Position Plate ... ..			
171055	-	" " " " " " " " " " 171054 with 171056, 171057 and two 51159j ... ..			
171056	2672	" " " " " " " " " " Position Plate Spring (back) ... ..			
171057	2672	" " " " " " " " " " " " (front) ... ..			
51159j	2672	" " " " " " " " " " " " Screw ... ..			
233zj	2672	" " " " " " " " " " " " Screw ... ..			
45789	2670	" " " " " " " " " " Tension Spring ... ..			
201016f	2670	" " " " " " " " " " " " Regulating Screw ... ..			
200592e	2670	" " " " " " " " " " " " Screw ... ..			
*45786	-	" " " " " " " " " " Flange ... ..			
*45787	-	" " " " " " " " " " Hub ... ..			
171058	2670	" " " " " " " " " " Collar and Counterbalance with 624al ... ..			
624al	2670	" " " " " " " " " " Set Screw ... ..			
170160	2670	" " " " " " " " " " Gib ... ..			
200614c	2670	" " " " " " " " " " Hinge Screw ... ..			
140694f	2670	" " " " " " " " " " Screw ... ..			



No.	Plate							
462a	2670	<b>Rotating Hook</b>	Set Screw	...	...	...	...	...
171059	2670	"	" Shaft	...	...	...	...	...
45854	2670	"	" " Bevel Gear with two 1259a	...	...	...	...	...
1259a	2670	"	" " " Set Screw	...	...	...	...	...
171060	2670	"	" " " Bushing (back)	...	...	...	...	...
624a	2670	"	" " " ( " ) Set Screw	...	...	...	...	...
171061	2670	"	" " " (front)	...	...	...	...	...
624a	2670	"	" " " ( " ) Set Screw	...	...	...	...	...
45761	2670	"	" " Loop Guard	...	...	...	...	...
200145c	2670	"	" " " Screw	...	...	...	...	...
45901		<b>Set of Mated Gears</b> (lower shaft), complete, Nos. 45852 and 45851						
171062		" " " " (upper shaft), complete, Nos. 45853 and 171005						
45863	2669	<b>Slack Thread Regulator and Tension Thread Guard</b>	...	...	...	...	...	...
335r	2669	"	" " " " " " " " Screw	...	...	...	...	...
45826	2669	<b>Spool Holder Spring</b>	...	...	...	...	...	...
45763	2670	<b>Stitch Indicator Plate</b>	...	...	...	...	...	...
51384zb	2670	"	" " " Screw (2)	...	...	...	...	...
51622zb	2670	"	" Regulating Thumb Nut	...	...	...	...	...
2102	2669	<b>Tension Disc</b>	...	...	...	...	...	...
45866	2669	"	" Indicator	...	...	...	...	...
45864	2669	"	" " Flange	...	...	...	...	...
45865	2669	"	" " " Stop Washer	...	...	...	...	...
51681zb	2669	"	" Regulating Thumb Nut with 45339	...	...	...	...	...
45339	2669	"	" " " " Engaging Pin	...	...	...	...	...
45909	2674	"	" Releasing Lever	...	...	...	...	...
51354c	2681	"	" " " Hinge Screw	...	...	...	...	...
33660	2674	"	" " " Spring	...	...	...	...	...
45868	2669	"	" " " Pin	...	...	...	...	...
45869	2669	"	" Spring	...	...	...	...	...
110167zj	2669	"	" Stud	...	...	...	...	...
45870	"	"	" " 110167zj with 51681zb	...	...	...	...	...
457a	2669	"	" " Set Screw	...	...	...	...	...
45871	2669	<b>Tension</b> (graduated), complete, Nos. 45861 to 45866, 45868 to 45870, 45873, 66774 and two 2102	...	...	...	...	...	...
26075	2671	<b>Thread Cutter and Holder</b>	...	...	...	...	...	...
8422	2669	"	" Guard (head of arm, upper)	...	...	...	...	...
45782	2669	"	" " (head of arm, lower)	...	...	...	...	...
45820	2674	"	" Take-up Crank	...	...	...	...	...
1036a	2681	"	" " " Set Screw	...	...	...	...	...
*45821	2674	"	" " Lever	...	...	...	...	...
45822	"	"	" " " complete, Nos. 45821, 45821 and 45825	...	...	...	...	...
45823	"	"	" " " 45822 with 45771, 45819, 45820, 50057c and 110165c	...	...	...	...	...

No.	Plate							
110165c	2676	<b>Thread Take-up Lever</b>	Cap Screw	...	...	...	...	...
*45824	2671	"	" " " Hinge Stud	...	...	...	...	...
*45825	2671	"	" " " Link	...	...	...	...	...
50057c	2671	"	" " " " Hinge Screw	...	...	...	...	...
45771	2674	"	" " " " " Washer	...	...	...	...	...
66774	2669	"	" " Spring	...	...	...	...	...
45873	2669	"	" " " Thread Guard	...	...	...	...	...
171063	2681	<b>Three-Pin Terminal Box Cover</b>	...	...	...	...	...	...
158x	2681	"	" " " " " Screw (2)	...	...	...	...	...
171064		"	" " " " Insulation	...	...	...	...	...
171065	2672	<b>Throat Plate</b>	...	...	...	...	...	...
171066		"	" " 171065 with 171055 and two 233zj	...	...	...	...	...
51023zj	2672	"	" " Screw (left) (2)	...	...	...	...	...
110666za	2672	"	" " " (right)	...	...	...	...	...

## SERIES C.A.K. 7 MOTORS

VOLTS	CYCLES	AMPERES	MOTOR CATALOGUE No.
32	D.C.	1.0	C.A.K. 7-3
50	D.C. & 25 to 75	.7	C.A.K. 7-5
95-100	D.C. & 25 to 75	.4	C.A.K. 7-6
100-110	D.C. & 25 to 75	.4	C.A.K. 7-7
110-120	D.C. & 25 to 75	.4	C.A.K. 7-8
150-165	D.C. & 25 to 75	.35	C.A.K. 7-9
190-210	D.C. & 25 to 75	.25	C.A.K. 7-10
210-230	D.C. & 25 to 75	.25	C.A.K. 7-11
230-250	D.C. & 25 to 75	.25	C.A.K. 7-12
120-130	D.C. & 25 to 75	.35	C.A.K. 7-14
130-145	D.C. & 25 to 75	.35	C.A.K. 7-15
200-220	D.C. & 80 to 100	.25	C.A.K. 7-90

## MOTOR PARTS

No.	Plate						
196651	---	Armature, for C.A.K. 7-3 Motor	...	...	...	...	...
196652	---	" " C.A.K. 7-5 Motor	...	...	...	...	...
196653	---	" " C.A.K. 7-6 Motor	...	...	...	...	...
196654	---	" " C.A.K. 7-7 Motor	...	...	...	...	...
196649	---	" " C.A.K. 7-8 Motor	...	...	...	...	...
196655	---	" " C.A.K. 7-9 Motor	...	...	...	...	...
196656	---	" " C.A.K. 7-10 Motor	...	...	...	...	...
196657	2675	" " C.A.K. 7-11 Motor	...	...	...	...	...
196658	---	" " C.A.K. 7-12 Motor	...	...	...	...	...
196659	---	" " C.A.K. 7-14 Motor	...	...	...	...	...
196660	---	" " C.A.K. 7-15 Motor	...	...	...	...	...
196661	---	" " C.A.K. 7-90 Motor	...	...	...	...	...
191097	2675	Armature Shaft Thrust Washer (phenolic)	...	...	...	...	...
191098	2675	" " " " (phenolic)	...	...	...	...	...
701400	2675	" " " " (pulley end) (phenolic)	...	...	...	...	...
191144	2675	Belt (moulded)	...	...	...	...	...
192457	2675	Brush (carbon, $\frac{7}{32}$ " square)	...	...	...	...	...
195435	2675	Brush Cap	...	...	...	...	...
194113	2675	" Holder Tube	...	...	...	...	...
192458	2675	" Spring	...	...	...	...	...
193536	2675	Commutator, complete	...	...	...	...	...
193907	2676	" Oil Sling	...	...	...	...	...
196332	---	" " " (Denmark, Norway and Sweden)	...	...	...	...	...
195833	2675	End Cover (commutator end)	...	...	...	...	...
196642	2675	" " (pulley end)	...	...	...	...	...
110445	2675	" " Fastening Screw (2)	...	...	...	...	...
199119	---	Field Coil (left) for 199121	...	...	...	...	...
199120	---	" " (right) for 199121	...	...	...	...	...
199121	---	" " complete, Nos. 199119 and 199120, for C.A.K. 7-3 Motor	...	...	...	...	...
199122	---	" " (left) for 199124	...	...	...	...	...
199123	---	" " (right) for 199124	...	...	...	...	...
199124	---	" " complete, Nos. 199122 and 199123, for C.A.K. 7-5 Motor	...	...	...	...	...
199125	---	" " (left) for 199127	...	...	...	...	...
199126	---	" " (right) for 199127	...	...	...	...	...
199127	---	" " complete, Nos. 199125 and 199126, for C.A.K. 7-6 Motor	...	...	...	...	...

No.	Plate				
199097	---	Field Coil (left) for 199095	...	...	...
199096	---	" " (right) for 199095	...	...	...
199095	---	" " complete, Nos. 199096 and 199097, for C.A.K. 7-7	...	...	...
Motor					
199100	---	" " (left) for 199098	...	...	...
199099	---	" " (right) for 199098	...	...	...
199098	---	" " complete, Nos. 199099 and 199100, for C.A.K. 7-8	...	...	...
Motor					
199138	---	" " (left) for 199140	...	...	...
199139	---	" " (right) for 199140	...	...	...
199140	---	" " complete, Nos. 199138 and 199139, for C.A.K. 7-9	...	...	...
Motor					
199103	---	" " (left) for 199101	...	...	...
199102	---	" " (right) for 199101	...	...	...
199101	---	" " complete, Nos. 199102 and 199103, for C.A.K. 7-10	...	...	...
Motor					
199106	---	" " (left) for 199104	...	...	...
199105	---	" " (right) for 199104	...	...	...
199104	2675	" " complete, Nos. 199105 and 199106, for C.A.K. 7-11	...	...	...
Motor					
199109	---	" " (left) for 199107	...	...	...
199108	---	" " (right) for 199107	...	...	...
199107	---	" " complete, Nos. 199108 and 199109, for C.A.K. 7-12	...	...	...
Motor					
199128	---	" " (left) for 199130	...	...	...
199129	---	" " (right) for 199130	...	...	...
199130	---	" " complete, Nos. 199128 and 199129, for C.A.K. 7-14	...	...	...
Motor					
199131	---	" " (left) for 199133	...	...	...
199132	---	" " (right) for 199133	...	...	...
199133	---	" " complete, Nos. 199131 and 199132, for C.A.K. 7-15	...	...	...
Motor					
199134	---	" " (left) for 199136	...	...	...
199135	---	" " (right) for 199136	...	...	...
199136	---	" " complete, Nos. 199134 and 199135, for C.A.K. 7-90	...	...	...
Motor					
820343	2676	" " Insulation	...	...	...
196360	2588	" " Lead Insulating Sleeve	...	...	...
194717	2675	" " " Strain Relief	...	...	...
196168	2675	" " " Retainer	...	...	...
197032	2675	" " Core, complete	...	...	...
†991601	2675	" " " Shield and Nameplate	...	...	...
195913	2675	" " " " " " " Insulation	...	...	...
195436	2675	Motor Pulley	...	...	...
51207r	2675	" " Set Screw	...	...	...
51208r	2675	" " Screw	...	...	...
8905	2675	" " Washer	...	...	...

† When ordering, state motor with which it is to be used.

No.	Plate				
194326	2675	Oil Lubricating Spring (commutator end)	...	...	...
194494	2675	" " Tube (commutator end)	...	...	...
196643	---	" " " (pulley end)	...	...	...
194490	2675	" " Wick (commutator end)	...	...	...
196644	---	" " " (pulley end)	...	...	...
*195049	---	Three Pin Terminal Body (male half)	...	...	...
195048	---	" " " ( " " ) 195049 with three 195050	...	...	...
*195051	---	" " " ( " " ) Contact Prong	...	...	...
*195050	---	" " " ( " " ) " " 195051	...	...	...
with 195052					
*195052	---	" " " ( " " ) " Prong Screw	...	...	...
Post					
198178	2680	" " " ( " " ) Terminal Post Nut	...	...	...
701719	2680	" " " ( " " ) " " Washer	...	...	...
199010	2680	Three Pin Terminal Body (male half), complete, Nos. 195048,	...	...	...
three each 198178 and 701719					
145r	2680	Three Pin Terminal Body (male half) Screw	...	...	...
196354	2673	" " " Box Cover	...	...	...
196357	---	" " " " 196354 with 196356	...	...	...
196356	2673	" " " " Insulating Lining (leatheroid)...	...	...	...
51369r	2680	" " " " Screw (small)	...	...	...
704r	2680	" " " " " (large)	...	...	...
196363	2673	" " " " Bushing (rubber) for SINGER	...	...	...
Light and Suppressor Leads					
196364	2673	" " " " Bushing (rubber) for Motor	...	...	...
Leads					
196358	2588	" " " " Insulation (leatheroid)	...	...	...
190439	2682	Tube filled with Singer Lubricant for Electric Motors	...	...	...
190613	---	" " 190439 with 190612	...	...	...
190612	---	" " Carton (paper)	...	...	...

## PLUGS

No.	Plate				
198052	2680	Two Pin Plug, complete, Nos. SS542, 193403, 193404, two each	...	...	...
SS541 and 198051, for V.D.E. and Norway					
193403	---	Two-Pin Plug Body (upper half)	...	...	...
193404	---	" " " (lower half) with insert	...	...	...
SS542	2680	" " " " Fastening Screw	...	...	...
198051	2680	" " " Contact Pin	...	...	...
SS541	2680	" " " " Screw	...	...	...
97382	2680	Bayonet Plug, complete, Nos. 97383 and 97384, for Great Britain	...	...	...
and Australia					
97383	2680	" Plug Body	...	...	...
97384	2680	" " Cover	...	...	...

## FOOT CONTROLLERS

(Moulded)

NOTE: These Controllers are fitted with Radio Interference Suppressor which is not included in the number.

No.	Plate	
198995	2582	Controller, complete, for 32 to 55 volts, A.C. or D.C. Motor, Nos. 194321, 194569, 194573, 195092, 899287, two 964317, four each 140099x and 194407 ... ..
198995	2582	Controller, complete, for 32 to 55 volts, A.C. or D.C. Motor, Nos. 194321, 194569, 194573, 199014, 899287, two 964317, four each 140099x and 194407 ... ..
198996	2582	Controller, complete, for 95 to 145 volts, A.C. or D.C. Motor, Nos. 194321, 194570, 194573, 195092, 199023, two 964317, four each 140099x and 194407 ... ..
198996	2582	Controller, complete, for 95 to 145 volts, A.C. or D.C. Motor, Nos. 194321, 194570, 194573, 199014, 199023, two 964317, four each 140099x and 194407 ... ..
198996	2582	Controller, complete, for 95 to 145 volts, A.C. or D.C. Motor, Nos. 194321, 194573, 199014, 199023, two 964317, four each 140099x and 194407 ... ..
198997	2582	Controller, complete, for 150 to 250 volts, A.C. or D.C. Motor, Nos. 194321, 194571, 194573, 195092, 199024, two 964317, four each 140099x and 194407 ... ..
198997	2582	Controller, complete, for 150 to 250 volts, A.C. or D.C. Motor, Nos. 194321, 194571, 194573, 199014, 199024, two 964317, four each 140099x and 194407 ... ..
198997	2582	Controller, complete, for 150 to 250 volts, A.C. or D.C. Motor, Nos. 194321, 194573, 198998, 199014, 199024, two 964317, four each 140099x and 194407 ... ..
194572	2582	Controller Base with two 194419 ... ..
194569	2582	" " " 194572 with 192211, 194418, 194774, 194775, two each 23258, 140100x, 140103x, 194404, 194514 and 931090 ... ..
194570	2582	Controller Base, 194572 with 192140, 194418, 194774, 194775, two each 23258, 140100x, 140103x, 194404, 194514 and 931090 ... ..
194571	2582	Controller Base 194572 with 192141, 194418, 194774, 194775, two each 23258, 140100x, 140103x, 194404, 194514 and 931090 ... ..
199003	2582	Controller Base 194572 with 194418, 194775, 196258, two each 23258, 140100x, 140103x, 194404, 194514 and 931090 ... ..
198998	2582	Controller Base 194572 with 194418, 194775, 196259, two each 23258, 140100x, 140103x, 194404, 194514 and 931090 ... ..

No.	Plate	
194407	2582	Controller Base Cushion (rubber) ... ..
140099x	2582	" " Screw ... ..
194573	2582	" Cover ... ..
194321	2582	" Foot Pedal ... ..
195096	2582	" Lead Cord (long) 8', for 195092 ... ..
*195094	2582	" " " (short) 3' 10", for 195093 ... ..
195093	2582	" " " 3' 10", complete, Nos. 194577, 194604, 195094 and two 195834, for 195092 ... ..
195092	2582	Controller Lead Cord, complete, from supply socket to three-pin terminal and controller, Nos. 195093, 195096, 198963 and Plug, for 198995 to 198997, for Great Britain and Australia ... ..
199017	2582	Controller Lead Cord (long) 8', for 199014 ... ..
199015	2582	" " " (short) 3' 10", for 199016 ... ..
199016	2582	" " " 3' 10", complete, Nos. 194577, 194604, 199015 and two 195834, for 199014 ... ..
199014	2582	Controller Lead Cord, complete, from supply socket to three-pin terminal and controller, Nos. 198999, 199016, 199017 and Plug, for 198995 to 198997, for Denmark, Norway, Sweden, Switzerland and V.D.E. ... ..
194577	2676	Controller Lead Cord Insulating Sleeve 2 $\frac{11}{16}$ " long ... ..
*194604	2676	" " Insulating Sleeve 3 $\frac{11}{16}$ " long ... ..
195834	2679	" " Terminal Eyelet ... ..
199077	2676	Controller Radio and Television Interference Suppressor Capacitor (.04 microfarads) ... ..
199078	2676	Controller Radio and Television Interference Suppressor Capacitor, complete, Nos. 198414 and 199077 ... ..
199087	2676	Controller Radio and Television Interference Suppressor Clamp Terminal Clip ... ..
198414	2676	Controller Radio and Television Interference Suppressor Terminal Clip ... ..
199086	2676	Controller Radio and Television Interference Suppressor Capacitor, complete, Nos. 199078 and 199087 ... ..
192211	2676	Controller Resistance Unit, 32 to 55 volts ... ..
192140	2582	" " " 95 to 145 volts ... ..
192141	2582	" " " 150 to 250 volts ... ..
196258	2582	" " " 192140 with 196255 ... ..
196259	2582	" " " 192141 with 196255 ... ..
194774	2676	" " " Adjusting Nut ... ..
196255	2676	" " " " " (bakelite) ... ..
194775	2582	" " " " " Lock Spring ... ..
194403	2676	" " " Bell Crank for 194416 ... ..
194416	2582	" " " " " complete, Nos. 194405 and two 194403 ... ..
513406	2582	" " " " " Hinge Screw ... ..
1607j	2582	" " " " " Nut ... ..
194404	2582	" " " " " Spring ... ..
194402	2582	" " " " " Bracket ... ..
140100x	2676	" " " " " " " Screw ... ..

## FOOT CONTROLLERS

No.	Plate							
194418		Controller Resistance Unit Bell Crank Spring Bracket 194402						
		with 194416, 194773, two each 1607j and 51340	...	...	...	...	...	...
194514	2676	Controller Resistance Unit Bell Crank Spring Bracket Screw						
		Insulating Disc	...	...	...	...	...	...
194405	2676	Controller Resistance Unit Bell Crank Spring Position Pin	...					
194419		" " " Insert Nut (brass)	...					
140103x	2582	" " " Screw	...					
931090	2676	" " " Washer (asbestos)	...					
23258	2676	" " " " (steel)	...					
193384	2582	" " " Short Circuiting Contact (2)	...					
51327j	2582	" " " " " Screw (2)	...					
191773	2582	" " " Yoke	...					
51340c	2582	" " " " Hinge Screw	...					
1607j	2582	" " " " " Nut	...					
*899287		Name Plate for 198995	...					
*199023		" " " 198996	...					
*199024		" " " 198997	...					
964317	2676	" " Drive Screw	...					
198970		Three Pin Terminal (female half) Housing (lower) with three						
								195058
198968		" " ( " " ) " ( " ) 198970 with						
								three each 140125 and 195057
*195057		" " ( " " ) Housing (lower) Contact						
								Prong
*195058		" " ( " " ) " ( " ) Insert	...					
140125	2680	" " ( " " ) " ( " ) Lead Screw	...					
198967		" " ( " " ) " (upper)	...					
198954	2588	" " ( " " ) " Protection Sleeve	...					
								(flat, flexible)
51093x	2582	" " ( " " ) " Screw	...					
1768x	2582	" " ( " " ) " Nut	...					
195059	2582	" " ( " " ) " Snap Ring	...					
198963	2582	Three-Pin Terminal (female half), complete, Nos. 198967, 198968,						
		two each 1768x, 51093x, 195059 and 198954, for 195092	...					
199002		Three Pin Terminal (female half) Housing (lower) with three						
								195058
199001		" " ( " " ) " ( " ) 199002 with						
								three each 140125 and 195057
199000		" " ( " " ) Housing (upper)	...					
198960	2588	" " ( " " ) " Protection Sleeve	...					
								(round, flexible)
198999		Three-pin Terminal (female half), complete, Nos. 199000,						
		199001, two each 1768x, 51093x, 195059 and 198960 for						
		199014	...					

February, 1956

FORM K6134

(List of Parts for 222K1 Machine)

## ALTERATIONS

Page 8--

Plate 2582 Alter 198995 to 198996

Page 31--

8879 Delete

Page 48 and Numerical--

160810 After 121464, add two 8879

Numerical--

8879 Delete (packed with Attachments), and insert for 160810

June, 1957

**FORM K6134**

(List of Parts for 222K1 Machine)

**ALTERATIONS**

Page 34 and Numerical.—

45734 Delete with 32519  
32519 "

Page 47.—

45859 Alter to 45929, and delete 45860 and  
45913 " " 45932, " " plate  
51497zb " " 140138zb, and delete plate

Page 47 and Numerical.—

45860 Obsolete  
45914 " use 45931  
1607r Delete

Page 49 and Numerical.—

121875 Obsolete  
140347w "  
121876 "  
121877 " use 161127  
87586 Add Nos. 101336 and 101337  
96416 " " 101346 " 101347  
87589 " " 101338 " 101339  
87593 " " 101340 " 101341  
87595 " " 101342 " 101343  
96422 " " 101358 " 101359  
87597 " " 101344 " 101345

Page 50.—

Insert new descriptions.—

96417 — Round,  $5\frac{3}{8}$ " diam.  $\times$   $7\frac{m}{m}$ " high, complete, Nos. 101348 and 101349  
96418 2193 " 7" "  $\times$   $7\frac{m}{m}$ " " " Nos. 101350 and 101351  
96419 — " 8" "  $\times$   $7\frac{m}{m}$ " " " Nos. 101352 and 101353  
96420 — " 10" "  $\times$   $7\frac{m}{m}$ " " " Nos. 101354 and 101355  
96421 — " 12" "  $\times$   $7\frac{m}{m}$ " " " Nos. 101356 and 101357  
96423 — Oval, 9"  $\times$   $4\frac{1}{2}$ "  $\times$   $7\frac{m}{m}$ " high, complete, Nos. 101360 and 101361  
96424 — " 12"  $\times$   $5\frac{1}{2}$ "  $\times$   $7\frac{m}{m}$ " " " Nos. 101362 and 101363

Form K6134 —continued.

Page 50 and Numerical. —

96425 Delete 96417, 96423 and 96424, and insert 101349, 101361 and 101363  
96426 " 96418 to 96420, 96423 and 96424, and insert 101351, 101353, 101355, 101361 and 101363  
96427 " 96417 to 96420, 96423 and 96424, and insert 101349, 101351, 101353, 101355, 101361 and 101362  
96844 Alter 96421 to 101357  
96845 " 96421 to 101357

Numerical. —

NN95j Delete 96417 to 96421, 96423 and 96424, and insert 101349, 101351, 101353, 101355, 101357, 101361 and 101363  
SS528j Delete 96417 to 96421, 96423 and 96424, and insert 101349, 101351, 101353, 101355, 101357, 101361 and 101363  
45838 Alter 45859 to 45929  
45847 " 45914 " 45931  
45862 " 45859 " 45929  
45913 Obsolete, use 45932  
45915 Alter 45914 to 45931  
45916 " 45914 " 45931  
51497zb Obsolete, use 140138zb

Insert new descriptions.—

96417 — Embroidery Hoop (round, birch)  $5\frac{3}{8}$ " diam.  $\times$   $7\frac{m}{m}$ " high, complete, Nos. 101348 and 101349  
96418 2193 Embroidery Hoop (round, birch) 7" diam.  $\times$   $7\frac{m}{m}$ " high, complete, Nos. 101350 and 101351  
96419 — Embroidery Hoop (round, birch) 8" diam.  $\times$   $7\frac{m}{m}$ " high, complete, Nos. 101352 and 101353  
96420 — Embroidery Hoop (round, birch) 10" diam.  $\times$   $7\frac{m}{m}$ " high, complete, Nos. 101354 and 101355  
96421 — Embroidery Hoop (round, birch) 12" diam.  $\times$   $7\frac{m}{m}$ " high, complete, Nos. 101356 and 101357  
96423 — Embroidery Hoop (oval, birch) 9"  $\times$   $4\frac{1}{2}$ "  $\times$   $7\frac{m}{m}$ " high, complete, Nos. 101360 and 101361  
96424 Embroidery Hoop (oval, birch) 12"  $\times$   $5\frac{1}{2}$ "  $\times$   $7\frac{m}{m}$ " high, complete, Nos. 101362 and 101363

Form K6134—continued.

**ADDITIONS**

Page 47

45931 --- Tension Bracket, complete, Nos. 45847, 45915, 45916, 45932 and 140138zb ... ..

Page 49

**PRESSER FOOT**

(for Cording and Slide Fastener Work)

No.	Plate	
140728	---	Presser Foot Adjusting Thumb Screw ... ..
161122	---	" " " " " Spring ... ..
161123	---	" " Hinge Pin ... ..
161124	---	" " Plate ... ..
161125	---	" " Shank (adjustable) ... ..
161126	---	" " " (stationary) ... ..
161127	---	Presser Foot (hinged, adjustable) for sewing on the right or left side of the needle, complete, Nos. 140728 and 161122 to 161126

101336	---	Embroidery Hoop (inner) for 87586 ... ..
101337	---	" " (outer) for 87586 ... ..
101338	---	" " (inner) for 87589 ... ..
101339	---	" " (outer) for 87589 ... ..
101340	---	" " (inner) for 87593 ... ..
101341	---	" " (outer) for 87593 ... ..
101342	---	" " (inner) for 87595 ... ..
101343	---	" " (outer) for 87595 ... ..
101344	---	" " (inner) for 87597 ... ..
101345	---	" " (outer) for 87597 ... ..
101346	---	" " (inner) for 96416 ... ..
101347	---	" " (outer) for 96416 ... ..
101358	---	" " (inner) for 96422 ... ..
101359	---	" " (outer) for 96422 ... ..

Form K6134—continued.

**ADDITIONS**

Page 50

101348	---	Embroidery Hoop (inner) for 96417 ... ..
101349	---	" " (outer) with SS528j, NN95j, two 96425 and four 96427, for 96417 ... ..
101350	---	" " (inner) for 96418 ... ..
101351	---	" " (outer) with SS528j, NN95j, two 96426 and four 96427, for 96418 ... ..
101352	---	" " (inner) for 96419 ... ..
101353	---	" " (outer) with SS528j, NN95j, two 96426 and four 96427, for 96419 ... ..
101354	---	" " (inner) for 96420 ... ..
101355	---	" " (outer) with SS528j, NN95j, two 96426 and four 96427, for 96420 ... ..
101356	---	" " (inner) for 96421 ... ..
101357	---	" " (outer) with SS528j, NN95j, two 96844 and four 96845, for 96421 ... ..
101360	---	" " (inner) for 96423 ... ..
101361	---	" " (outer) with SS528j, NN95j, 96425, 96426 and four 96427, for 96423 ... ..
101362	---	" " (inner) for 96424 ... ..
101363	---	" " (outer) with SS528j, NN95j, 96425, 96426 and four 96427, for 96424 ... ..

**EMBROIDERY HOOP (with Spring)  
(Birch)**

No.	Plate	
101364	---	Hoop (inner) for 101246 ... ..
101365	---	" (outer) with Spring, for 101246 ... ..
101246	---	Hoop (round) 10" diam. x $\frac{1}{16}$ " high, complete, Nos. 101364 and 101365

Form K6134—continued.

NUMERICAL SECTION

45929	---	Bobbin Winder Frame 45838 with 45862	...
45931	---	Bobbin Winder Tension Bracket, complete, Nos. 45847, 45915, 45916, 45932 and 140138zb	...
45932	---	Bobbin Winder Tension Bracket for 45931	...
101246	—	Embroidery Hoop (round, birch) 10" diam. x $\frac{7}{16}$ " high, complete, Nos. 101364 and 101365	...
101336	—	Embroidery Hoop (inner) for 87586	...
101337	—	Embroidery Hoop (outer) for 87586	...
101338	—	Embroidery Hoop (inner) for 87589	...
101339	---	Embroidery Hoop (outer) for 87589	...
101340	—	Embroidery Hoop (inner) for 87593	...
101341	—	Embroidery Hoop (outer) for 87593	...
101342	---	Embroidery Hoop (inner) for 87595	...
101343	---	Embroidery Hoop (outer) for 87595	...
101344	---	Embroidery Hoop (inner) for 87597	...
101345	---	Embroidery Hoop (outer) for 87597	...
101346	—	Embroidery Hoop (inner) for 96416	...
101347	---	Embroidery Hoop (outer) for 96416	...
101348	---	Embroidery Hoop (inner) for 96417	...
101349	---	Embroidery Hoop (outer) with SS528j, NN95j, two 96425 and four 96427, for 96417	...
101350	—	Embroidery Hoop (inner) for 96418	...
101351	---	Embroidery Hoop (outer) with SS528j, NN95j, two 96426 and four 96427, for 96418	...
101352	—	Embroidery Hoop (inner) for 96419	...
101353	---	Embroidery Hoop (outer) with SS528j, NN95j, two 96426 and four 96427, for 96419	...
101354	---	Embroidery Hoop (inner) for 96420	...
101355	---	Embroidery Hoop (outer) with SS528j, NN95j, two 96426 and four 96427, for 96420	...
101356	—	Embroidery Hoop (inner) for 96421	...
101357	---	Embroidery Hoop (outer) with SS528j, NN95j, two 96844 and four 96845, for 96421	...
101358	---	Embroidery Hoop (inner) for 96422	...
101359	---	Embroidery Hoop (outer) for 96422	...

Form K6134 continued.

NUMERICAL SECTION

101360	---	Embroidery Hoop (inner) for 96423	...
101361	---	Embroidery Hoop (outer) with SS528j, NN95j, 96425, 96426 and four 96427 for 96423	...
101362	---	Embroidery Hoop (inner) for 96424	...
101363	---	Embroidery Hoop (outer) with SS528j, NN95j, 96425, 96426 and four 96427, for 96424	...
101364	—	Embroidery Hoop (inner) for 101246	...
101365	---	Embroidery Hoop (outer) with Spring, for 101246	...
140138zj	---	Bobbin Winder Tension Disc Screw for 45932	...
140728	---	Presser Foot Adjusting Thumb Screw for 161127	...
161122	---	Presser Foot Adjusting Thumb Screw Spring for 161127	...
161123	---	Presser Foot Hinge Pin for 161127	...
161124	---	Presser Foot Plate for 161127	...
161125	---	Presser Foot Shank (adjustable) for 161127	...
161126	---	Presser Foot Shank (stationary) for 161127	...
161127	---	Presser Foot (hinged, adjustable) for sewing on the right or left side of the needle, complete, Nos. 140728 and 161122 to 161126	...



## SINGER LIGHT

No.	Plate	
*193254	2679	Light Lamp Contact Lead Terminal for 199006
*193633	2679	" " " " " " 193634
*193278	2679	" " " " " " Plate
*193634	-	" " " " " " 193278 with 193633, for 199009
51203	2679	" " " " " " Screw (brass)
*193253	2679	" " " " Plunger
*193251	-	" " " " " " Bushing
*193252	2679	" " " " " " Spring
199079	-	" Lead for 199080
199084	-	" " " " 199085
196328	2679	" " " " Slot Cover
196355	2679	" " " " Strain Relief Disc
195831	2679	" " " " Terminal Eyelet
50566	2679	" " " " " " Screw (brass) for 199081
51290	2679	" " " " " ( " ) " 199137
199080	2679	Light Lead, complete, Nos. 199079 and two 195831, for Great Britain and Australia
199085	-	Light Lead, complete, Nos. 199084 and two 195831, for Denmark, Norway, Switzerland and Sweden
196326	2679	Light Shade
193437	2679	" " " " Friction Washer
196330	2679	" " " " Insulating Bushing
*193267	2679	" " " " Position Pin
*199007	-	" " " " Socket Body, with 193255 and two 193251
199081	2679	Light Socket, complete, Nos. 196327, 196328, 196355, 199006, 199080, two each 50566 and 51385x, for Great Britain and Australia
199137	-	Light Socket, complete, Nos. 196327, 196328, 196355, 199009, 199085, two each 51290 and 51385x, for Denmark, Norway, Switzerland and Sweden
*199006	-	Light Switch Mechanism, complete, Nos. 51399, 193251, 193256 to 193258, 194659, 199007, two each 51203, 193252, 193253 and 193267, for 199081
*199009	-	Light Switch Mechanism, complete, Nos. 51399, 193257, 193258, 193634, 193635, 194659, 199007, two each 51203, 193252, 193253 and 193267, for 199137
*193259	2679	Light Toggle Switch Contact
*194660	2679	" " " " " " Frame
51399	2679	" " " " " " Screw (brass)
*194599	2679	" " " " " " Operating Lever
*194661	2679	" " " " " " Hinge Pin
194659	-	Light Toggle Switch, complete, Nos. 193259, 193387, 193765, 194599, 194660, 194661 and 194695

## SINGER LIGHT

No.	Plate	
196327	2679	Light Toggle Switch Shell ... ..
51385x	2679	" " " " Screw ... ..
*193258	2679	" " " " Spring Contact (left) ... ..
*193257	2679	" " " " " (right) ... ..
51203	2679	" " " " " " ( " ) Screw ... ..
*193256	2679	" " " " " " Lead Terminal for 199006 ... ..
*193633	2679	" " " " " " " " " " 193635 ... ..
193276	2679	Light Toggle Switch Spring Contact Lead Terminal Plate for 193635 ... ..
193635		Light Toggle Switch Spring Contact Lead Terminal Plate 193276 with 193633, for 199009 ... ..
193255		Light Toggle Switch Spring Contact Lead Terminal Stud ... ..
*193387	2679	" " " " Toggle Lever ... ..
194695	2679	" " " " " " Spring ... ..
*193765	2679	" " " " " " Washer ... ..
199082	2679	SINGER Light (moulded, less Lamp), complete, Nos. 641zj, (Great Britain and Australia) 193137, 196326, 196330 and 199081 ... ..
199082	2679	SINGER Light (moulded, less Lamp), complete, Nos. 641zj, (Denmark, Norway, Switzerland, Sweden and V.D.E.) 193137, 196326, 196330 and 199137 ... ..
641zj	2679	Light Screw ... ..

## SINGER LIGHT LAMP

No.	Plate	
194120	2679	Light Lamp ... ..

NOTE. In ordering it is necessary to state the exact voltage required.

Example: 194120, 240 Volts.

## BOBBIN WINDER PARTS

(The Belt Guard is an Integral Part of the Machine Arm)

No.	Plate	
*15838		Frame ... ..
15859	2669	" 15838 with 15860 and 15862 ... ..
51355zb	2669	" Hinge Screw ... ..
45775	2669	" " " " Friction Washer (under head of screw) ... ..
15812	2669	" " " " Washer (between frame and belt guard) ... ..
*15860		Pulley ... ..
*15861		Spindle ... ..
*15862		" 15861 with 15836 and 15837 ... ..
*15836		" Bobbin Retaining Ring ... ..
*15837		" " " " Collar ... ..
45913	2669	Tension Bracket ... ..
45914	2669	Tension Bracket, complete, Nos. 1607r, 15847, 45913, 45916, 51497zb and two 45915 ... ..
4423zb	2669	Tension Bracket Screw ... ..
45915	2669	" Disc ... ..
51497zb	2669	" " Screw ... ..
1607r	2669	" " " Nut ... ..
45916	2669	" " " Washer ... ..
45847	2669	" " Spring ... ..

## ATTACHMENTS

### ATTACHMENT SET

(Supplied with Machine to Great Britain)

No.	Plate	
121464	2574	Binder ... ..
36865	2574	Edge Stitcher ... ..
121441	2574	Gathering Foot (double toe) ... ..
35931	2574	Hemmer (adjustable) ... ..
15 x 1	-	Needles (6) ... ..
86642	2574	Ruffler ... ..
25537	2574	Screw Driver (machine) ... ..
120378	2574	" " (bobbin case) ... ..
8879	2574	Spool Pin Washer (cloth) ... ..
160810		Set of Attachments, complete, Nos. 25537, 35931, 36865, 86642, 120378, 121441, 121464 and six needles ... ..
171071	2678	Darning Foot ... ..
120855	2678	Hemmer (Foot) $\frac{3}{4}$ " hem ... ..
45785	2681	Rotating Hook Bobbin (4) ... ..
120861		Tin of Oil (3 oz.) ... ..

The following may be purchased separately:

25525	2678	Bias Gauge ... ..
25527b	2678	Cloth Guide ... ..
50053b	2678	" " and Under Braider Thumb Screw ... ..
120914	2678	Feller (Foot) ... ..
35932	2678	Quilter ... ..
121170	909	Ruffler Shirring Plate ... ..
25539	2678	Stiletto ... ..
36583	1956	Tucker ... ..
121547	909	Under Braider ... ..

### BRAIDER

No.	Plate	
25510	-	Braider ... ..

### CORDING FEET

For Stitching on Edge, Cording and Slide Fastener Work.

No.	Plate	
160845	2678	Presser Foot (left toe) ... ..
160846	2678	" " (right toe) ... ..
121875	"	" " Body ... ..
140347w	2678	" " Adjusting Thumb Screw ... ..
121876	"	" " Body ... ..
121877	2678	Presser Foot (adjustable for sewing on the right or left side of the needle), complete, Nos. 121875, 121876 and 140347w, for Cording and Slide Fastener Work ... ..

### IMITATION HEMSTITCHING ATTACHMENT

No.	Plate	
120787	1956	With Yielding Presser Plate ... ..

### NEEDLE THREADER (UNIVERSAL)

No.	Plate	
121631	2682	Needle Threader Hook ... ..
140157j	2682	" " Screw ... ..
121632	2682	" " with 140157j and three 121631 ... ..

### DARNING HOOP

No.	Plate	
171072	2677	Darning Hoop Body Ring, complete ... ..
171073	2677	" " Clamping Ring ... ..
171074	2677	Darning Hoop, complete, Nos. 171072 and 171073 ... ..

### EMBROIDERY HOOPS (Plain) (Birch)

No.	Plate	
87586		Round, $5\frac{1}{2}$ " diam. x 7 mm. high ... ..
96416		" 7" " x 7 mm. " ... ..
87589	1221	" 8" " x 7 mm. " ... ..
87593		" 10" " x $\frac{7}{16}$ " high ... ..
87595		" 12" " x $\frac{1}{2}$ " " ... ..
96422	1221	Oval, 9" x $4\frac{1}{2}$ " x 7 mm. " ... ..
87597		" 12" x $5\frac{1}{2}$ " x 7 mm. " ... ..

**EMBROIDERY HOOPS (with Clamp)  
(Birch)**

No.	Plate	
96417	...	Round, 5½" diam. × 7 mm. high, with SS528j, XX95j, two 96425 and four 96427
96418	...	" 7" " × 7 mm. " " SS528j, XX95j, two 96426 and four 96427
96419	...	" 8" " × 7 mm. " " SS528j, XX95j, two 96426 and four 96427
96420	...	" 10" " × 7 mm. " " SS528j, XX95j, two 96426 and four 96427
96421	...	" 12" " × 7 mm. " " SS528j, XX95j, two 96414 and four 96415
96423	...	Oval, 9" × 4½" × 7 mm. high, with SS528j, XX95j, 96425, 96426 and four 96427
96424	...	" 12" × 5½" × 7 mm. " " SS528j, XX95j, 96425, 96426 and four 96427
96425	2399	Clamping Bracket for 96417, 96423 and 96424
96426	2399	" " " 96418 to 96420, 96423 and 96424
96844	2399	" " " 96421
96427	2399	Rivet for 96417 to 96420, 96423 and 96424
96845	2399	" " " 96421
SS528j	2399	Screw
XX95j	2399	" Nut

**PORTABLE CARRYING CASE**

No.	Plate	
Set 271	...	Carrying Case

**NUMERICAL LIST OF PARTS**

No.	Plate	
XX95j	2399	Embroidery Hoop Clamping Bracket Screw Nut, for 96417 to 96421, 96423 and 96424
129x	2681	Bed Leg Screw for 171011
141r	2681	Bed Cover (tubular) Screw
145r	2680	Three-Pin Terminal Body (male half) Screw
158x	2681	Three-Pin Terminal Box Cover Screw
206x	2680	Lamp Lead Shield (side of arm) Screw
208al	2672	Feed Dog Screw
233zj	2672	Rotating Hook Bobbin Case Position Plate Screw for 171066
248za	2670	Clamp Stop Motion Clamp Set Screw
330x	2669	Arm Top Cover Screw
335r	2669	Slack Thread Regulator and Tension Thread Guard Screw
453al	2674	Presser Bar Guide Bracket Set Screw for 171053
457al	2669	Tension Stud Set Screw
458al	2681	Cloth Plate Guide Pin (short, back) Set Screw for 171019
458al	2681	Cloth Plate Guide Pin (long, front) Set Screw for 171019
462al	2674	Needle Bar Bushing (upper) Set Screw
462al	2670	Rotating Hook Set Screw for 170135
SS528j	2399	Embroidery Hoop Clamping Bracket Screw for 96417 to 96421, 96423 and 96424
SS544	2680	Two-Pin Plug Contact Pin Screw for 198052
SS542	2680	Two-Pin Plug Body Fastening Screw for 198052
624al	2672	Feed Rock Shaft Centre (left) Set Screw
624al	2672	Feed Rock Shaft Centre (right) Set Screw
624al	2672	Feed Lifting Rock Shaft Centre (left) Set Screw
624al	2672	Feed Lifting Rock Shaft Centre (right) Set Screw
624al	2670	Rotating Hook Collar and Counterbalance Set Screw for 171058
624al	2670	Rotating Hook Shaft Bushing (front) Set Screw for 171011
624al	2670	Rotating Hook Shaft Bushing (back) Set Screw for 171011
641zj	2679	Light Screw for 199082
704r	2680	Three-Pin Terminal Box Cover Screw (large)
1036al	2681	Thread Take-up Crank Set Screw for 45740

No.	Plate	
1134al	2670	Needle Bar Crank Position Screw for 45740
1191zb	2681	Cloth Plate Guide Pin (long, front) Thumb Screw
1259al	2670	Arm Shaft (upright) Bevel Gear (lower) Set Screw for 45852
1259al	2670	Arm Shaft (upright) Bevel Gear (upper) Set Screw for 45853
1259al	2670	Rotating Hook Shaft Bevel Gear Set Screw for 45854
1423zb	2669	Bobbin Winder Tension Bracket Screw
1520e	2670	Feed Lifting Forked Connection Hinge Screw Nut
1520e	2670	Feed Rock Shaft Forked Connection Hinge Screw Nut
1607j	2582	Controller Resistance Unit Bell Crank Hinge Screw Nut for 194418
1607j	2582	Controller Resistance Unit Yoke Hinge Screw Nut for 194418
1607r	2669	Bobbin Winder Tension Disc Screw Nut for 45914
1735e	2670	Feed Reversing Handle Lock Nut
1768x	2582	Three Pin Terminal (female half) Housing Screw Nut for 198963 and 198999
1780r	2671	Bed Cover Plate (bottom) Screw Thumb Nut
2102	2669	Tension Disc for 45871
8217	2670	Feed Regulator Hinge Screw Friction Washer
8217	2670	Feed Throw-out Lever Hinge Screw Friction Washer
8422	2669	Thread Guard (head of arm, upper)
8879	2669	Arm Top Cover Spool Pin Washer (cloth) (packed with Attachments)
8905	2675	Motor Screw Washer
9046	2670	Arm Dowel Pin
23258	2676	Controller Resistance Unit Screw Washer (steel) for 194569 to 194571, 198998 and 199003
25510	--	Braider
25525	2678	Bias Gauge
25527b	2678	Cloth Guide
25537	2574	Screw Driver (machine) for 160810
25539	2678	Stiletto
26075	2674	Thread Cutter and Holder
32519	2674	Needle Stop Pin for 45734
*32774	-	Presser Foot Shank for 45321
33624	2674	Pressure Regulating Thumb Screw Extension Pin for 45813
33660	2674	Tension Releasing Lever Spring

No.	Plate	
35931	2574	Hemmer (adjustable) for 160810
35932	2678	Quilter
36583	1956	Tucker
36865	2574	Edge Stitcher for 160810
*45319	-	Presser Foot Plate for 45321
45321	2674	Presser Foot (hinged), complete, Nos. 32774, 45319 and 45329
45329	2674	Presser Foot Hinge Pin for 45321
45339	2669	Tension Regulating Thumb Nut Engaging Pin for 51684zb
45704	2670	Arm Shaft (horizontal) Bushing for 171002
45705	2670	Arm Shaft (upright)
45708	2669	Arm Top Cover for 45795
45709	2669	Arm Top Cover Spool Pin for 45795
45714	2674	Bed Extension Hinge Screw Friction Washer for 171023
45716	2670	Clamp Stop Motion Clamp Washer
45717	2670	Clamp Stop Motion Flanged Bushing for 45765
45718	-	Face Plate for 45719
45719	2669	Face Plate 45718 with 45842 and 439615
45732	2670	Feed Reversing Handle for 45794
45734	2674	Needle Bar (hollow) with 32519
45736	2674	Needle Bar Bushing (upper)
45739	2674	Needle Bar Connecting Stud with 51363e, for 45819
45740	2670	Needle Bar Crank with 1036al and 1134al, for 171004
45741	2674	Presser Bar (hollow)
45744	2674	Presser Bar Lifter Hinge Pin
45745	2674	Presser Bar Spring for 45813
*45750	-	Rotating Hook Bobbin Case for 45751
45751	2670	Rotating Hook Bobbin Case, complete, Nos. 45750, 45789, 200592c, 200964e, 201016l, 206736 and 210736, for 45925
45761	2670	Rotating Hook Loop Guard for 45924
45763	2670	Stitch Indicator Plate
45765	-	Clamp Stop Motion Flanged Bushing 45717 with 51350zb
45771	2674	Thread Take-up Lever Link Hinge Screw Washer for 45823
45775	2669	Bobbin Winder Frame Hinge Screw Friction Washer (under head of screw)
45782	2669	Thread Guard (head of arm, lower)
45785	2681	Rotating Hook Bobbin, Nos. 45787 and two 45786
*45786	-	Rotating Hook Bobbin Flange for 45785

No.	Plate	
*45787	—	Rotating Hook Bobbin Hub for 45785 ...
45789	2670	Rotating Hook Bobbin Case Tension Spring for 45751 ...
45794	—	Feed Reversing Handle 45732 with 51622zb
45795	2669	Arm Top Cover 45708 with 45709 ...
45798	2671	Bed Extension Hinge Screw Washer for 171023 ...
45812	2669	Bobbin Winder Frame Hinge Screw Washer (between frame and belt guard) ...
45813	—	Presser Bar Spring 45745 with 33624 ...
45817	2670	Hand Wheel ...
45818	2674	Needle Bar Connecting Link for 45819 ...
45819	—	Needle Bar Connecting Link 45818 with 45739, for 45823 ...
45820	2674	Thread Take-up Crank for 45823 ...
*45821	2674	Thread Take-up Lever for 45822 ...
45822	—	Thread Take-up Lever, complete, Nos. 45821, 45824 and 45825, for 45823 ...
45823	—	Thread Take-up Lever 45822 with 45771, 45819, 45820, 50057c and 140165e ...
*45824	2674	Thread Take-up Lever Hinge Stud for 45822
*45825	2674	Thread Take-up Lever Link for 45822 ...
45826	2669	Spool Holder Spring ...
*45836	—	Bobbin Winder Spindle Bobbin Retaining Ring for 45862 ...
*45837	—	Bobbin Winder Spindle Bobbin Retaining Ring Collar for 45862 ...
*45838	—	Bobbin Winder Frame for 45859 ...
45842	—	Face Plate Thread Guard (lower) 45875 with 125424, for 45719 ...
45847	2669	Bobbin Winder Tension Disc Spring for 45914
45852	2670	Arm Shaft (upright) Bevel Gear (lower) with two 1259al, for 45901 ...
45853	2670	Arm Shaft (upright) Bevel Gear (upper) with two 1259al, for 171062 ...
45854	2670	Rotating Hook Shaft Bevel Gear with two 1259al, for 45901 ...
45859	2669	Bobbin Winder Frame 45838 with 45860 and 45862 ...
*45860	—	Bobbin Winder Pulley for 45859 ...
*45861	—	Bobbin Winder Spindle for 45862 ...
*45862	—	Bobbin Winder Spindle 45861 with 45836 and 45837, for 45859 ...
45863	2669	Slack Thread Regulator and Tension Thread Guard ...
45864	2669	Tension Indicator Flange for 45871 ...

No.	Plate	
45865	2669	Tension Indicator Flange Stop Washer for 45871 ...
45866	2669	Tension Indicator for 45871 ...
45868	2669	Tension Releasing Pin for 45871 ...
45869	2669	Tension Spring for 45871 ...
45870	—	Tension Stud 110167zj with 51681zb, for 45871 ...
45871	2669	Tension (graduated) complete, Nos. 45864 to 45866, 45868 to 45870, 45873, 66774 and two 2102 ...
45873	2669	Thread Take-up Spring Thread Guard for 45871 ...
45874	2669	Face Plate Thread Guard (upper) for 139645
45875	2669	Face Plate Thread Guard (lower) for 45842
45877	2681	Needle Clamp Body with 110545z, for 45878
45878	2674	Needle Clamp Body 45877 with 51398zj ...
45879	2674	Needle Clamp Gibs and Thread Guard ...
45901	—	Set of Mated Gears (lower shaft), complete, Nos. 45852 and 45851 ...
45909	2674	Tension Releasing Lever ...
45910	2674	Presser Bar Lifter ...
45913	2669	Bobbin Winder Tension Bracket for 45914 ...
45914	2669	Bobbin Winder Tension Bracket, complete, Nos. 4607r, 45847, 45913, 45916, 51197zb and two 45915 ...
45915	2669	Bobbin Winder Tension Disc for 45914 ...
45916	2669	Bobbin Winder Tension Disc Screw Washer for 45914 ...
45924	—	Rotating Hook 170135 with 45761, 45926, 110694l, 170160, 200145c and 200614e, for 45925 ...
45925	2670	Rotating Hook (with Yielding Gibs and Bobbin Case, complete, Nos. 45754 and 45924 ...
45926	2670	Rotating Hook Bobbin Case Base for 45924
50053b	2678	Cloth Guide and Under Braider Thumb Screw ...
50054zb	2674	Pressure Regulating Thumb Screw ...
50057c	2674	Thread Take-up Lever Link Hinge Screw for 45823 ...
50353c	2670	Feed Regulator Hinge Screw ...
50353e	2670	Feed Throw-out Lever Hinge Screw
50566	2679	Light Lead Terminal Screw (brass) for 199084
50684zb	2669	Face Plate Thumb Screw ...
51023za	2672	Throat Plate Screw (left) ...

No.	Plate	
51093x	2582	Three-Pin Terminal (female half) Housing Screw for 198963 and 198999 ...
51159j	2672	Rotating Hook Bobbin Case Position Plate Spring Screw for 171055 ...
51203	2679	Light Lamp Contact Lead Terminal Screw (brass) for 199006 and 199009 ...
51203	2679	Light Toggle Switch Spring Contact (right) Screw for 199006 and 199009 ...
51207r	2675	Motor Pulley Set Screw ...
51208r	2675	Motor Screw ...
51290	2679	Light Lead Terminal Screw (brass) for 199137 ...
51308zj	2674	Needle Clamp Position Screw for 15878 ...
51327j	2582	Controller Resistance Unit Short Circuiting Contact Screw ...
51340c	2582	Controller Resistance Unit Bell Crank Hinge Screw for 194418 ...
51340c	2582	Controller Resistance Unit Yoke Hinge Screw for 194418 ...
51350zb	2670	Clamp Stop Motion Clamp Screw for 45765 ...
51351al	2670	Clamp Stop Motion Flanged Bushing Screw ...
51354e	2681	Tension Releasing Lever Hinge Screw ...
51355zb	2669	Bobbin Winder Frame Hinge Screw ...
51361r	2671	Bed Cover Plate (bottom) Screw ...
51363e	2674	Needle Bar Connecting Stud Clamping Screw for 45739 ...
51369r	2680	Three-Pin Terminal Box Cover Screw (small) ...
51380r	2671	Bed Extension Hinge Screw for 171023 ...
51384zb	2670	Feed Throw-out Lever Plate Screw ...
51384zb	2670	Stitch Indicator Plate Screw ...
51385x	2679	Light Toggle Switch Shell Screw for 199081 and 199137 ...
51399	2679	Light Toggle Switch Frame Screw (brass) for 199006 and 199009 ...
51472e	2670	Arm Screw ...
51497zb	2669	Bobbin Winder Tension Disc Screw for 45914 ...
51622zb	2670	Stitch Regulating Thumb Nut for 45794 ...
51681zb	2669	Tension Regulating Thumb Nut with 45339, for 45870 ...
51759e	2670	Feed Bar Adjusting Sleeve Lock Nut for 171030 ...
51941	- -	Feed Rock Shaft Forked Connection Roller for 51942 ...
51942	2670	Feed Rock Shaft Forked Connection Roller 51941 with 140665c, for 171048 ...
66774	2669	Thread Take-up Spring for 45871 ...
86642	2574	Ruffler for 160810 ...

No.	Plate	
87586		Embroidery Hoop (round, birch), 5 $\frac{3}{8}$ " diam. $\times$ 7 mm. high ...
87589	1221	Embroidery Hoop (round, birch), 8" diam. $\times$ 7 mm. high ...
87593		Embroidery Hoop (round, birch), 10" diam. $\times$ $\frac{7}{16}$ " high ...
87595		Embroidery Hoop (round, birch), 12" diam. $\times$ $\frac{1}{2}$ " high ...
87597		Embroidery Hoop (oval, birch), 12" $\times$ 5 $\frac{1}{2}$ " $\times$ 7 mm. high ...
96416		Embroidery Hoop (round, birch) 7" diam. $\times$ 7 mm. high ...
96417		Embroidery Hoop (round, birch), 5 $\frac{3}{8}$ " diam. $\times$ 7 mm. high with SS528j, NN95j, two 96425 and four 96427 ...
96418		Embroidery Hoop (round, birch), 7" diam. $\times$ 7 mm. high with SS528j, NN95j, two 96426 and four 96427 ...
96419		Embroidery Hoop (round, birch), 8" diam. $\times$ 7 mm. high with SS528j, NN95j, two 96426 and four 96427 ...
96420		Embroidery Hoop (round, birch), 10" diam. $\times$ $\frac{7}{16}$ " high with SS528j, NN95j, two 96426 and four 96427 ...
96421		Embroidery Hoop (round, birch), 12" diam. $\times$ $\frac{1}{2}$ " high with SS528j, NN95j, two 96844 and four 96845 ...
96422	1221	Embroidery Hoop (oval, birch), 9" $\times$ 4 $\frac{1}{2}$ " $\times$ 7 mm. high ...
96423		Embroidery Hoop (oval, birch), 9" $\times$ 4 $\frac{1}{2}$ " $\times$ 7 mm. high with SS528j, NN95j, 96425, 96426 and four 96427 ...
96424		Embroidery Hoop (oval, birch), 12" $\times$ 5 $\frac{1}{2}$ " $\times$ 7 mm. high with SS528j, NN95j, 96425, 96426 and four 96427 ...
96425	2399	Embroidery Hoop Clamping Bracket for 96417, 96423 and 96424 ...
96426	2399	Embroidery Hoop Clamping Bracket for 96418 to 96420, 96423 and 96424 ...
96427	2399	Embroidery Hoop Clamping Bracket Rivet for 96417 to 96420, 96423 and 96424 ...
96844	2399	Embroidery Hoop Clamping Bracket for 96421 ...
96845	2399	Embroidery Hoop Clamping Bracket Rivet for 96421 ...
97382	2680	Rayonet Plug, complete, Nos. 97383 and 97384, for Great Britain and Australia ...

No.	Plate	
97383	2680	Bayonet Plug Body for 97382 ... ..
97384	2680	Bayonet Plug Cover for 97382 ... ..
120378	2574	Screw Driver (bobbin case) for 160810 ... ..
120687	1956	Imitation Hemstitching Attachment with Yielding Presser Plate ... ..
120855	2678	Hemmer (foot) $\frac{3}{4}$ " hem ... ..
120861	---	Tin of Oil (3 oz.) ... ..
120914	2678	Feller (foot) ... ..
121170	909	Ruffler Shirring Plate ... ..
121441	2574	Gathering Foot (double toe) for 160810 ... ..
121461	2574	Binder for 160810 ... ..
121547	909	Under Braider ... ..
121631	2682	Needle Threader Hook for 121632 ... ..
121632	2682	Needle Threader (universal), with 119157j and three 121631 ... ..
121875	---	Presser Foot for 121877 ... ..
121876	---	Presser Foot Body for 121877 ... ..
121877	2678	Presser Foot (adjustable for sewing on the right or left side of the needle), complete, Nos. 121875, 121876 and 110317w, for Cording and Slide Fastener Work ... ..
125421	2669	Face Plate Thread Guard (lower) Rivet for 45812 ... ..
125424	2669	Face Plate Thread Guard (upper) Rivet for 139615 ... ..
139615	---	Face Plate Thread Guard (upper) 45874 with 125424, for 45719 ... ..
140099x	2582	Controller Base Screw for 198995 to 198997 ... ..
140100x	2676	Controller Resistance Unit Bell Crank Spring Bracket Screw for 194569 to 194571, 198998 and 199003 ... ..
140103x	2582	Controller Resistance Unit Screw for 194569 to 194571, 198998 and 199003 ... ..
140125	2680	Three-Pin Terminal (female half) Housing (lower) Lead Screw for 198968 and 199001 ... ..
140157j	2682	Needle Threader Hook Screw for 121632 ... ..
140167zj	2669	Tension Stud for 45870 ... ..
140240zb	2674	Presser Foot Thumb Screw ... ..
140347w	2678	Presser Foot Adjusting Thumb Screw for 121877 ... ..
140445	2675	End Cover Fastening Screw ... ..
140465e	2676	Thread Take-up Lever Cap Screw for 45823 ... ..
140545zc	2681	Needle Clamp Thumb Screw for 45877 ... ..
140558al	2670	Arm Shaft (horizontal) Bevel Gear Feed Cam and Feed Lifting Eccentric Set Screw for 171005 ... ..

No.	Plate	
140558c	2670	Arm Shaft (horizontal) Counterbalance Set Screw for 171006 ... ..
140660c	2672	Feed Bar and Feed Lifting Rock Shaft Connecting Link Hinge Screw Stud for 171038 ... ..
140661c	2672	Feed Bar and Feed Rock Shaft Connecting Link Hinge Screw Stud for 171016 ... ..
140662c	2681	Feed Bar Retainer Plate Set Screw ... ..
140663c	2670	Feed Lifting Forked Connection Hinge Screw (eccentric) ... ..
140663c	2670	Feed Rock Shaft Forked Connection Hinge Screw (eccentric) ... ..
140664zb	2670	Feed Throw-out Lever Screw ... ..
140665c	---	Feed Rock Shaft Forked Connection Roller Stud for 51942 ... ..
140666za	2672	Throat Plate Screw (right) ... ..
140682e	2671	Bed Cushion Screw for 171011 ... ..
140682e	2671	Bed Leg Cushion Screw for 171011 ... ..
140682e	2671	Cloth Plate Cushion Screw for 171019 ... ..
140694f	2670	Rotating Hook Gib Screw for 45921 ... ..
160810	---	Set of Attachments, complete, Nos. 25537, 35931, 36865, 86612, 120378, 121441, 121464 and six needles ... ..
160845	2678	Presser Foot for Stitching on Edge, Cording and Slide Fastener Work (left toe) ... ..
160846	2678	Presser Foot for Stitching on Edge, Cording and Slide Fastener Work (right toe) ... ..
170135	2670	Rotating Hook with two 462al, for 45921 ... ..
170160	2670	Rotating Hook Gib for 45921 ... ..
*171001	---	Arm for 171002 ... ..
*171002	---	Arm 171001 with 171007, 171008, 171009 and two 45704 ... ..

*NOTE. -Due to the accuracy required for gear alignment, Arm cannot be supplied separately and can only be sent as a unit, Arm and Bed assembled.*

171003	2670	Arm Shaft (horizontal) for 171004 ... ..
171004	---	Arm Shaft (horizontal) 171003 with 45740 ... ..
171005	2670	Arm Shaft (horizontal) Bevel Gear, Feed Cam and Feed Lifting Eccentric with 140558al, for 171062 ... ..
171006	2670	Arm Shaft (horizontal) Counterbalance with 140558c ... ..
171007	2670	Arm Shaft (upright) Bushing (lower) for 171002 ... ..
171008	2670	Arm Shaft (upright) Bushing (upper) for 171002 ... ..



No.	Plate	
171009	2670	Arm Shaft (upright) Lamp Lead Shield for 171002 ... ..
*171010		Bed for 171011 ... ..
*171011		Bed 171010 with 171017, 171018, 171060, two each 129x, 624al, 171083, four each 140682e and 171084 ... ..
<i>NOTE.--Due to the accuracy required for gear alignment, Bed cannot be supplied separately and can only be sent as a unit, Arm and Bed assembled.</i>		
171012		Bed Cover (tubular) ... ..
171013		Bed Cover Plate (bottom) for 171014 ... ..
171011	2671	Bed Cover Plate (bottom) 171013 with 171015
171015		Bed Cover Plate (bottom) Felt for 171014
171016	2671	Bed Extension for 171023 ... ..
171017		Bed Leg (back) for 171014 ... ..
171018		Bed Leg (front) for 171014 ... ..
171019		Cloth Plate with 140682e, 171084 and two 458al, for 171020 ... ..
171020	2671	Cloth Plate, complete, Nos. 171019, 171021 and 171022, for 171023 ... ..
171021	2681	Cloth Plate Guide Pin (short, back) for 171020
171022	2681	Cloth Plate Guide Pin (long, front) for 171020
171023	2671	Cloth Plate with Bed Extension, complete, Nos. 45714, 45798, 171016, 171020 and two 51380r ... ..
171024	2670	Feed Bar for 171030 ... ..
171025	2670	Feed Bar Adjusting Sleeve for 171030 ... ..
171026	2672	Feed Bar and Feed Lifting Rock Shaft Connecting Link for 171038 ... ..
171026	2672	Feed Bar and Feed Rock Shaft Connecting Link for 171016 ... ..
171027	2670	Feed Bar Guide Plate for 171030 ... ..
171028	2670	Feed Bar Retainer Plate for 171030 ... ..
171029	2681	Feed Bar Retainer Plate Locating Pin ... ..
171030	2670	Feed Bar with Rotating Hook Shaft Bushing Nos. 51759e, 171024, 171025, 171027, 171028 and 171061 ... ..
171031	2672	Feed Dog, 12 teeth (14 teeth to the inch) for 171066 ... ..
171032	2670	Feed Lifting Forked Connection for 171033
171033		Feed Lifting Forked Connection 171032 with 171035 ... ..
171034		Feed Lifting Forked Connection Slide Block for 171035 ... ..
171035		Feed Lifting Forked Connection Slide Block 171034 with 171036, for 171033 ... ..

No.	Plate	
171036		Feed Lifting Forked Connection Slide Block Stud for 171035 ... ..
171037	2672	Feed Lifting Rock Shaft for 171038 ... ..
171038		Feed Lifting Rock Shaft 171037 with 140660e and 171026 ... ..
171039	2672	Feed Lifting Rock Shaft Centre (left) ... ..
171039	2672	Feed Lifting Rock Shaft Centre (right) ... ..
171039	2672	Feed Rock Shaft Centre (left) ... ..
171039	2672	Feed Rock Shaft Centre (right) ... ..
171040	2670	Feed Throw-out Lever ... ..
171042	2670	Feed Throw-out Lever Positioning Sleeve ... ..
171043	2670	Feed Throw-out Lever Spring ... ..
171044	2670	Feed Regulator ... ..
171045	2672	Feed Rock Shaft for 171046 ... ..
171046		Feed Rock Shaft 171045 with 140661e and 171026 ... ..
171047	2670	Feed Rock Shaft Forked Connection for 171048 ... ..
171048		Feed Rock Shaft Forked Connection 171047 with 51942 ... ..
171050	2673	Lamp Lead Shield (underside of bed) ... ..
171051	2673	Lamp Lead Shield (side of arm) ... ..
171053	2671	Presser Bar Guide Bracket with 453al ... ..
171054	2672	Rotating Hook Bobbin Case Position Plate for 171055 ... ..
171055		Rotating Hook Bobbin Case Position Plate 171054, with 171056, 171057 and two 51159j, for 171066 ... ..
171056	2672	Rotating Hook Bobbin Case Position Plate Spring (back) for 171055 ... ..
171057	2672	Rotating Hook Bobbin Case Position Plate Spring (front) for 171055 ... ..
171058	2670	Rotating Hook Collar and Counterbalance with 624al ... ..
171059	2670	Rotating Hook Shaft ... ..
171060	2670	Rotating Hook Shaft Bushing (back) for 171011 ... ..
171061	2670	Rotating Hook Shaft Bushing (front) for 171030 ... ..
171062		Set of Mated Gears (upper shaft), complete, Nos. 45853 and 171005 ... ..
171063	2681	Three-Pin Terminal Box Cover ... ..
171064		Three-Pin Terminal Box Insulation ... ..
171065	2672	Throat Plate for 171066 ... ..
171066		Throat Plate 171065 with 171055 and two 233zj ... ..
171071	2678	Darning Foot ... ..

No.	Plate	
171072	2677	Darning Hoop Body Ring, complete, for 171074 ... ..
171073	2677	Darning Hoop Clamping Ring for 171074 ...
171074	2677	Darning Hoop, complete, Nos. 171072 and 171073 ... ..
171083	2681	Bed Spacer for 171011 ... ..
171084	2671	Bed Cushion (rubber) for 171011 ... ..
171084	2671	Bed Leg Cushion (rubber) for 171011 ... ..
171084	2671	Cloth Plate Cushion for 171019 ... ..
171086	2670	Feed Throw out Lever Plate ... ..
190439	2682	Tube filled with Singer Lubricant for Electric Motors for 190613 ... ..
190612	- - -	Tube Carton (paper) for 190613 ... ..
190613	- - -	Tube 190439 with 190612 ... ..
191097	2675	Armature Shaft Thrust Washer (phenolic) ...
191098	2675	Armature Shaft Thrust Washer (phenolic) ...
192140	2582	Controller Resistance Unit for 95 to 115 volts, for 194570 and 196258 ... ..
192141	- - -	Controller Resistance Unit for 150 to 250 volts, for 194571 and 196259 ... ..
192211	- - -	Controller Resistance Unit, for 32 to 50 volts, for 194569 ... ..
192457	2675	Brush (carbon $\frac{3}{32}$ " square) ... ..
192458	2675	Brush Spring ... ..
*193251	- - -	Light Lamp Contact Plunger Bushing for 199007 ... ..
*193252	2679	Light Lamp Contact Plunger Spring for 199006 and 199009 ... ..
*193253	2679	Light Lamp Contact Plunger for 199006 and 199009 ... ..
*193254	2679	Light Lamp Contact Lead Terminal for 199006 ... ..
*193255	- - -	Light Toggle Switch Spring Contact Lead Terminal Stud for 199007 ... ..
*193256	2679	Light Toggle Switch Spring Contact Lead Terminal for 199006 ... ..
*193257	2679	Light Toggle Switch Spring Contact (right) for 199006 and 199009 ... ..
*193258	2679	Light Toggle Switch Spring Contact (left) for 199006 and 199009 ... ..
*193259	2679	Light Toggle Switch Contact for 194659 ... ..
*193267	2679	Light Shade Position Pin for 199006 and 199009 ... ..
193276	2679	Light Toggle Switch Spring Contact Lead Terminal Plate for 193635 ... ..

No.	Plate	
*193278	2679	Light Lamp Contact Lead Terminal Plate for 193634 ... ..
193384	2582	Controller Resistance Unit Short Circuiting Contact ... ..
*193387	2679	Light Toggle Switch Toggle Lever for 194659
193403	- - -	Two-Pin Plug Body (upper half) for 198052
193404	- - -	Two-Pin Plug Body (lower half) with insert for 198052 ... ..
193437	2679	Light Shade Friction Washer for 199082 ... ..
193536	2675	Commutator, complete ... ..
*193633	2679	Light Lamp Contact Lead Terminal for 193634 ... ..
*193633	2679	Light Toggle Switch Spring Contact Lead Terminal for 193635 ... ..
*193634	- - -	Light Lamp Contact Lead Terminal Plate 193278 with 193633, for 199009 ... ..
193635	- - -	Light Toggle Switch Spring Contact Lead Terminal Plate 193276 with 193633, for 199009 ... ..
*193765	2679	Light Toggle Switch Toggle Lever Spring Washer for 194659 ... ..
193907	2676	Commutator Oil Sling ... ..
194113	2675	Brush Holder Tube ... ..
194120	2679	Light Lamp ... ..
<i>NOTE: In ordering it is necessary to state the exact voltage required.</i>		
194144	2675	Belt (moulded) ... ..
194321	2582	Controller Foot Pedal for 198995 to 198997
194326	2675	Oil Lubricating Spring (commutator end) ...
194402	2582	Controller Resistance Unit Bell Crank Spring Bracket for 194418 ... ..
194403	2676	Controller Resistance Unit Bell Crank for 194416 ... ..
194404	2582	Controller Resistance Unit Bell Crank Spring for 194569 to 194571, 198998 and 199003
194405	2676	Controller Resistance Unit Bell Crank Spring Position Pin for 194416 ... ..
194407	2582	Controller Base Cushion (rubber) for 198995 to 198997 ... ..
194416	2582	Controller Resistance Unit Bell Crank, complete, Nos. 194405 and two 194403, for 194418 ... ..
194418	- - -	Controller Resistance Unit Bell Crank Spring Bracket 194402 with 194416, 194773, two each 1607j and 51340c, for 194569 to 194571, 198998 and 199003 ... ..

No.	Plate	
194419	-	Controller Resistance Unit Insert Nut (brass) for 194572 ... ..
194490	2675	Oil Lubricating Wick (commutator end) ...
194494	2675	Oil Lubricating Tube (commutator end) ...
194514	2676	Controller Resistance Unit Bell Crank Spring Bracket Screw Insulating Disc for 194569 to 194571, 198998 and 199003 ...
194569	-	Controller Base 194572 with 192211, 194418, 194774, 194775, two each 23258, 140100x, 140103x, 194401, 194514 and 931090, for 198995 ... ..
194570	-	Controller Base 194572 with 192140, 194418, 194774, 194775, two each 23258, 140100x, 140103x, 194401, 194514 and 931090, for 198996 ... ..
194571	-	Controller Base 194572 with 192141, 194418, 194774, 194775, two each 23258, 140100x, 140103x, 194401, 194514 and 931090, for 198997 ... ..
194572	2582	Controller Base with two 194419, for 194569 to 194571, 198998 and 199003 ...
194573	2582	Controller Cover for 198995 to 198997 ...
194577	2676	Controller Lead Cord Insulating Sleeve, 2 $\frac{11}{16}$ " long, for 195093 and 199016 ...
*194599	2679	Light Toggle Switch Operating Lever for 194659 ... ..
*194604	-	Controller Lead Insulating Sleeve, 3 $\frac{3}{16}$ " long, for 195093 and 199016 ... ..
*194659	-	Light Toggle Switch, complete, Nos. 193259, 193387, 193765, 194599, 194660, 194664 and 194695, for 199006 and 199009 ...
*194660	2679	Light Toggle Switch Frame for 194659 ...
*194661	2679	Light Toggle Switch Operating Lever Hinge Pin for 194659 ... ..
*194695	2679	Light Toggle Switch Toggle Lever Spring for 194659 ... ..
194717	2675	Field Coil Lead Strain Relief ... ..
194773	2582	Controller Resistance Unit Yoke for 194418
194774	2676	Controller Resistance Unit Adjusting Nut for 194569 to 194571 ... ..
194775	2582	Controller Resistance Unit Adjusting Nut Lock Spring for 194569 to 194571, 198998 and 199003 ... ..
195048	-	Three-Pin Terminal Body (male half) 195049 with three 195050, for 199010 ... ..
*195049	-	Three-Pin Terminal Body (male half) for 195048 ... ..

No.	Plate	
*195050	-	Three-Pin Terminal Body (male half) Contact Prong 195051 with 195052, for 195048 ...
*195051	-	Three-Pin Terminal Body (male half) Contact Prong for 195050 ... ..
*195052	-	Three-Pin Terminal Body (male half) Contact Prong Screw Post for 195050 ... ..
*195057	-	Three-Pin Terminal (female half) Housing (lower) Contact Prong for 198968 and 199001 ... ..
*195058	-	Three-Pin Terminal (female half) Housing (lower) Insert for 198970 and 199002 ...
195059	2582	Three-Pin Terminal (female half) Housing Snap Ring for 198963 and 198999 ...
195092	2582	Controller Lead Cord, complete, from Supply Socket to Three-Pin Terminal and Controller, Nos. 195093, 195096, 198963, and Plug, for 198995 to 198997, for Great Britain and Australia ... ..
195093	-	Controller Lead Cord 3' 10", complete, Nos. 194577, 194601, 195094 and two 195834, for 195092 ... ..
*195094	-	Controller Lead Cord (short) 3' 10", for 195093 ... ..
195096	-	Controller Lead Cord (long) 8', for 195092 ...
195435	2675	Brush Cap ... ..
195436	2675	Motor Pulley ... ..
195833	2675	End Cover (commutator end) ... ..
195834	2679	Controller Lead Terminal Eyelet for 195093 and 199016 ... ..
195834	2679	Light Lead Terminal Eyelet for 199080 and 199085 ... ..
195913	2675	Field Core Shield and Nameplate Insulation for 991601 ... ..
196168	2675	Field Coil Retainer ... ..
196255	2676	Controller Resistance Unit Adjusting Nut (bakelite) for 196258 and 196259 ...
196258	-	Controller Resistance Unit 192140 with 196255, for 199003 ... ..
196259	-	Controller Resistance Unit 192141 with 196255, for 198998 ... ..
196326	2679	Light Shade for 199082 ... ..
196327	2679	Light Toggle Switch Shell for 199081 and 199137 ... ..
196328	2679	Light Lead Slot Cover for 199081 and 199137
196330	2679	Light Shade Insulating Bushing for 199082

No.	Plate	
196332	----	Commutator Oil Sling (Denmark, Norway and Sweden) ... ..
196354	2673	Three-Pin Terminal Box Cover for 196357 ...
196355	2679	Light Lead Strain Relief Disc for 199081 and 199137 ... ..
196356	2673	Three-Pin Terminal Box Cover Insulating Lining (leatheroid) for 196357 ...
196357	-	Three-Pin Terminal Box Cover 196354 with 196356 ... ..
196358	2588	Three-Pin Terminal Box Insulation (leatheroid) ... ..
196360	2588	Field Coil Lead Insulating Sleeve ... ..
196363	2673	Three-Pin Terminal Box Cover Bushing (rubber) for SINGER Light and Suppressor Leads ... ..
196364	2673	Three-Pin Terminal Box Cover Bushing (rubber) for Motor Leads ... ..
196642	2675	End Cover (pulley end) ... ..
196643	-	Oil Lubricating Tube (pulley end) ... ..
196644	-	Oil Lubricating Wick (pulley end) ... ..
196649	-	Armature for C.A.K. 7-8 Motor ... ..
196651	----	Armature for C.A.K. 7-3 Motor ... ..
196652	-	Armature for C.A.K. 7-5 Motor ... ..
196653	-	Armature for C.A.K. 7-6 Motor ... ..
196654	---	Armature for C.A.K. 7-7 Motor ... ..
196655	-	Armature for C.A.K. 7-9 Motor ... ..
196656	-	Armature for C.A.K. 7-10 Motor ... ..
196657	2675	Armature for C.A.K. 7-11 Motor ... ..
196658	----	Armature for C.A.K. 7-12 Motor ... ..
196659	-	Armature for C.A.K. 7-14 Motor ... ..
196660	-	Armature for C.A.K. 7-15 Motor ... ..
196661	-	Armature for C.A.K. 7-90 Motor ... ..
197032	2675	Field Core, complete ... ..
198051	2680	Two-Pin Plug Contact Pin for 198052 ... ..
198052	2680	Two-Pin Plug, complete, Nos. SS542, 193403, 193404, two each SS544 and 198051, for V.D.E. and Norway ... ..
198178	2680	Three-Pin Terminal Body (male half) Terminal Post Nut for 199010 ... ..
198414	2676	Controller Radio and Television Interference Suppressor Terminal Clip for 199078 ...
198954	2588	Three-Pin Terminal (female half) Housing Protection Sleeve (flat, flexible) for 198963
198960	2588	Three-Pin Terminal (female half) Housing Protection Sleeve (round, flexible) for 198999 ... ..

No.	Plate	
198963	2582	Three-Pin Terminal (female half), complete, Nos. 198967, 198968, two each 1768x, 51093x, 195059 and 198954, for 195092
198967	-	Three-Pin Terminal (female half) Housing (upper) for 198963 ... ..
198968	-	Three-Pin Terminal (female half) Housing (lower) 198970 with three each 140125 and 195057, for 198963 ... ..
198970	-	Three-Pin Terminal (female half) Housing (lower) with three 195058, for 198968 ...
198995	2582	Controller, complete, for 32 to 55 volts, A.C. (Great Britain and Australia) or D.C. Motor, Nos. 194321, 194569, 194573, 195092, 899287, two 964317, four each 140099x and 194407 ...
198995	-	Controller, complete, for 32 to 55 volts, A.C. (Denmark, Norway, Switzerland and V.D.E.) or D.C. Motor, Nos. 194321, 194569, 194573, 199014, 899287, two 964317, four each 140099x and 194407 ...
198996	-	Controller, complete, for 95 to 145 volts, A.C. (Great Britain and Australia) or D.C. Motor, Nos. 194321, 194570, 194573, 195092, 199023, two 964317, four each 140099x and 194407 ...
198996	-	Controller, complete, for 95 to 145 volts, A.C. (Denmark, Norway, Switzerland and V.D.E.) or D.C. Motor, Nos. 194321, 194570, 194573, 199014, 199023, two 964317, four each 140099x and 194407 ...
198996	-	Controller, complete, for 95 to 145 volts, A.C. (Sweden) or D.C. Motor, Nos. 194321, 194573, 199003, 199014, 199023, two 964317, four each 140099x and 194407 ...
198997	-	Controller, complete, for 150 to 250 volts, A.C. or D.C. Motor, Nos. 194321, 194574, 194573, 195092, 199021, two 964317, four each 140099x and 194407 ...
198997	-	Controller, complete, for 150 to 250 volts, A.C. or D.C. Motor, Nos. 194321, 194574, 194573, 199014, 199021, two 964317, four each 140099x and 194407 ...
198997	-	Controller, complete, for 150 to 250 volts, A.C. or D.C. Motor, Nos. 194321, 194573, 198998, 199014, 199021, two 964317, four each 140099x and 194407 ...

No.	Plate	
198998 (Sweden)	--	Controller Base 194572 with 194418, 194775, 196259, two each 23258, 140100x, 140103x, 194404, 194514 and 931090, for 198997 ...
198999	---	Three-Pin Terminal (female half), complete, Nos. 199000, 199001, two each 17688, 51093x, 195059 and 198960, for 199014 ...
199000	---	Three-Pin Terminal (female half) Housing (upper) for 198999 ...
199001	---	Three-Pin Terminal (female half) Housing (lower) 199002 with three each 140125 and 195057, for 198999 ...
199002	---	Three-Pin Terminal (female half) Housing (lower) with three 195058, for 199001 ...
199003 (Sweden)	---	Controller Base 194572 with 194418, 194775, 196258, two each 23258, 140100x, 140103x, 194404, 194514 and 931090, for 198996 ...
*199006	---	Light Switch Mechanism, complete, Nos. 51399, 193254, 193256 to 193258, 194659, 199007, two each 51203, 193252, 193253 and 193267, for 199081 ...
*199007	--	Light Socket Body, with 193255 and two 193251, for 199006 and 199009 ...
*199009	--	Light Switch Mechanism, complete, Nos. 51399, 193257, 193258, 193634, 193635, 194659, 199007, two each 51203, 193252, 193253 and 193267, for 199137 ...
199010	2680	Three-Pin Terminal Body (male half), complete, Nos. 195048, three each 198178 and 701719 ...
199014	--	Controller Lead Cord, complete, from Supply Socket to Three-Pin Terminal and Controller, Nos. 198999, 199016, 199017 and Plug for 198995 to 198997, for Denmark, Norway, Sweden, Switzerland and V.D.E. ...
199015	---	Controller Lead Cord (short) 3' 10", for 199016 ...
199016	---	Controller Lead Cord 3' 10", complete, Nos. 194577, 194604, 199015 and two 195834, for 199014 ...
199017	---	Controller Lead Cord (long) 8', for 199014 ...
*199023	---	Name Plate for 198996 ...
*199024	---	Name Plate for 198997 ...
199077	---	Controller Radio and Television Interference Suppressor Capacitor (.01 microfarads), for 199078 ...

No.	Plate	
199078	--	Controller Radio and Television Interference Suppressor Capacitor, complete, Nos. 198414 and 199077, for 199086 ...
199079	---	Light Lead for 199080 ...
199080	2679	Light Lead, complete, Nos. 199079 and two 195834, for 199081 ...
199081	2679	Light Socket, complete, Nos. 196327, 196328, 196355, 199006, 199080, two each 50566 and 51385x, for 199082 ...
199082	2679	SINGER Light (moulded, less lamp), complete, Nos. 641zj, 193437, 196326, 196330 and 199081 ...
199082	2679	SINGER Light (moulded, less lamp), complete, Nos. 641zj, 193437, 196326, 196330 and 199137 ...
199084	---	Light Lead for 199085 ...
199085	---	Light Lead, complete, Nos. 199084 and two 195834, for 199137 ...
199086	---	Controller Radio and Television Interference Suppressor Capacitor, complete, Nos. 199078 and 199087, for 198995 to 198997 ...
199087	---	Controller Radio and Television Interference Suppressor Clamp for 199086 ...
199095	---	Field Coil, complete, Nos. 199096 and 199097, for C.A.K. 7-7 Motor ...
199096	---	Field Coil (right) for 199095 ...
199097	---	Field Coil (left) for 199095 ...
199098	---	Field Coil, complete, Nos. 199099 and 199100, for C.A.K. 7-8 Motor ...
199099	---	Field Coil (right) for 199098 ...
199100	---	Field Coil (left) for 199098 ...
199101	---	Field Coil, complete, Nos. 199102 and 199103, for C.A.K. 7-10 Motor ...
199102	---	Field Coil (right) for 199101 ...
199103	---	Field Coil (left) for 199101 ...
199104	2675	Field Coil, complete, Nos. 199105 and 199106, for C.A.K. 7-11 Motor ...
199105	---	Field Coil (right) for 199104 ...
199106	---	Field Coil (left) for 199104 ...
199107	---	Field Coil, complete, Nos. 199108 and 199109, for C.A.K. 7-12 Motor ...
199108	---	Field Coil (right) for 199107 ...
199109	---	Field Coil (left) for 199107 ...
199119	---	Field Coil (left) for 199121 ...

No.	Plate	
199120	--	Field Coil (right) for 199121
199121	--	Field Coil, complete, Nos. 199119 and 199120, for C.A.K. 7-3 Motor
199122	--	Field Coil (left) for 199121
199123	--	Field Coil (right) for 199121
199124	--	Field Coil, complete, Nos. 199122 and 199123, for C.A.K. 7-5 Motor
199125	--	Field Coil (left) for 199127
199126	--	Field Coil (right) for 199127
199127	--	Field Coil, complete, Nos. 199125 and 199126, for C.A.K. 7-6 Motor
199128	--	Field Coil (left) for 199130
199129	--	Field Coil (right) for 199130
199130	--	Field Coil, complete, Nos. 199128 and 199129, for C.A.K. 7-11 Motor
199131	--	Field Coil (left) for 199133
199132	--	Field Coil (right) for 199133
199133	--	Field Coil, complete, Nos. 199131 and 199132, for C.A.K. 7-15 Motor
199134	--	Field Coil (left) for 199136
199135	--	Field Coil (right) for 199136
199136	--	Field Coil, complete, Nos. 199134 and 199135, for C.A.K. 7-90 Motor
199137	--	Light Socket, complete, Nos. 196327, 196328, 196355, 199009, 199085, two each 51290 and 51385x, for 199082
199138	--	Field Coil (left) for 199140
199139	--	Field Coil (right) for 199140
199140	--	Field Coil, complete, Nos. 199138 and 199139, for C.A.K. 7-9 Motor
200145c	2670	Rotating Hook Loop Guard Screw for 45924
200592c	2670	Rotating Hook Bobbin Case Tension Spring Screw for 45751
200614c	2670	Rotating Hook Gib Hinge Screw for 45924
200964c	2681	Rotating Hook Bobbin Case Latch Stop Screw for 45751
201016f	2670	Rotating Hook Bobbin Case Tension Spring Regulating Screw for 45751
206731	--	Rotating Hook Bobbin Case Latch Fulcrum Pin for 206736
206735	--	Rotating Hook Bobbin Case Latch for 206736
206736	2670	Rotating Hook Bobbin Case Latch 206735 with 206731 and 206737, for 45751
206737	--	Rotating Hook Bobbin Case Latch Lever for 206736

No.	Plate	
210736	2670	Rotating Hook Bobbin Case Latch Spring for 45751
701400	2675	Armature Shaft Thrust Washer (pulley end, phenolic)
701719	2680	Three Pin Terminal Body (male half) Terminal Post Washer for 199010
820343	2676	Field Coil Insulation
*899287	--	Name Plate for 198995
931090	2676	Controller Resistance Unit Screw Washer (asbestos) for 194569 to 194571, 198998 and 199003
964317	2676	Name Plate Drive Screw for 198995 to 198997
†991601	2675	Field Core Shield and Name Plate

† When ordering, state motor with which it is to be used.