

SINGER

251-11

LIST OF PARTS COMPLETE
FOR

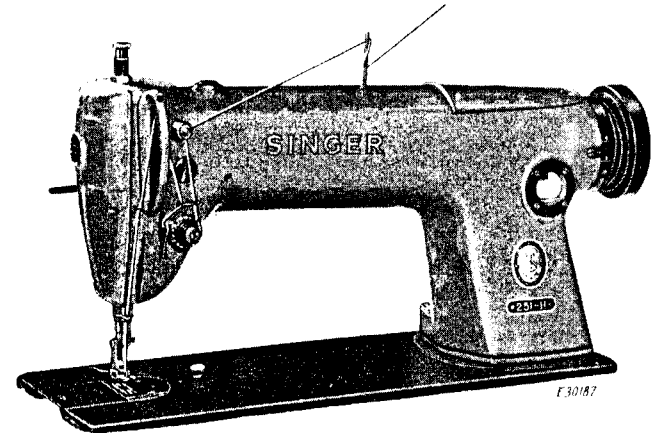

MACHINE No. 251-11

FOR GENERAL STITCHING OPERATIONS ON LIGHT TO MEDIUM WEIGHT FABRICS. HAS PENDANT LINK FEED MECHANISM. CLEARANCE UNDER PRESSER FOOT 9/32". NEEDLE BAR STROKE 1-9/64". MAXIMUM STITCH LENGTH 8 PER INCH.

No.	Plate	Name
*147001	-----	Arm
		NOTE: Due to the accuracy required for gear alignment, Arm cannot be supplied separately and can only be sent out as a unit, Arm and Bed assembled.
8582	8287	Arm Dowel Pin (2)
50608(819)	8269	Arm Hole Plug Screw (top of arm) for plugging hole used to assemble take-up oil wicks
140705(805)	8287	Arm Screw (back)
146552	8287	Arm Screw (front and intermediate) (2) ..
140315(805)	8287	Arm Screw Stud (back) (2)
147003	8269	Arm Shaft (horizontal) and Needle Bar Crank with 1036(830), 140542(830) and 140609(830)
147486	8269	Arm Shaft (horizontal) Bushing (center)
140296(830)	8269	Arm Shaft (horizontal) Bushing (center) Set Screw
147112	8269	Arm Shaft (horizontal) Flanged Bushing (back)

PARTS FOR MACHINE No. 251-11

No.	Plate	Name
146790	8269	Arm Shaft (horizontal) Flanged Bushing (back) Oil Sump Tube
207(805)	8269	Arm Shaft (horizontal) Flanged Bushing (back) Oil Sump Tube Holder Screw
140297(830)	8269	Arm Shaft (horizontal) Flanged Bushing (back) Set Screw
147005	8269	Arm Shaft (horizontal) Flanged Bushing (front)
140279(830)	8269	Arm Shaft (horizontal) Flanged Bushing (front) Set Screw
144(804)	8269	Arm Shaft (horizontal) Screw (back)
140640(805)	8269	Arm Shaft (horizontal) Screw Plug (front)
147109	8269	Arm Shaft (horizontal) Screw Plug Washer (fiber)
147468	8269	Arm Shaft (horizontal) Thrust Collar with two 457(830)
457(830)	8269	Arm Shaft (horizontal) Thrust Collar Set Screw (2)
143013	8269	Arm Shaft (upright)
143014	8269	Arm Shaft (upright) Bevel Gear (lower) right hand spiral with two 1259(830)
NOTE: To ensure proper functioning of Gears, No. 143014 will not be supplied separately, but will be substituted by Pair of Gears No. 143295.		
1259(830)	8269	Arm Shaft (upright) Bevel Gear (lower) Set Screw (2)
143015	8269	Arm Shaft (upright) Bevel Gear (upper) Left hand spiral with two 1259(830)
NOTE: To ensure proper functioning of Gears, No. 143015 will not be supplied separately, but will be substituted by Pair of Gears No. 147476.		
1259(830)	8269	Arm Shaft (upright) Bevel Gear (upper) Set Screw (2)
143016	8269	Arm Shaft (upright) Bushing (lower)
140298(830)	8269	Arm Shaft (upright) Bushing (lower) Set Screw
147111	8269	Arm Shaft (upright) Bushing (upper)
50504(830)	8269	Arm Shaft (upright) Bushing (upper) Set Screw
147007	8272	Arm Side Shield
147008	8272	Arm Side Shield Wick
16709	8272	Arm Side Shield Wick Spring Holder
147010	8272	Arm Side Shield complete, Nos. 16709, 147007 and 147008
217(819)	8272	Arm Side Shield Screw (2)
52239	8274	Arm Spool Pin and Thread Eyelet
8879	8274	Arm Spool Pin Washer (cloth)
NOTE: When ordering No. 8879, state color required.		

PARTS FOR MACHINE No. 251-11

No.	Plate	Name
147011	8275	Arm Top Cover for 147013
147012	8256	Arm Top Cover for 147014
147013	8275	Arm Top Cover with Stitch Regulator Plunger complete, Nos. 64519, 146511, 147011 and 147105
NOTE: No. 147013 is regularly furnished with this machine.		
147014	8256	Arm Top Cover with Stitch Regulator Plunger complete, when a longer spool pin (3-1/2 in. long) is required, Nos. 64519, 143244, 146511, 147012 and 147105
147015	8275	Arm Top Cover Gasket
51369(813)	8275	Arm Top Cover Screw (4)
143244	8256	Arm Top Cover Spool with Spool Rest, 3-1/2 in. long
147105	8256	Arm Top Cover Stitch Regulator Plunger
140607(819)	8256	Arm Top Cover Stitch Regulator Plunger Hole Plug Screw for plugging the Plunger hole when the Plunger is removed to prevent tampering with the stitch set
64519	8256	Arm Top Cover Stitch Regulator Plunger Spring
146511	8256	Arm Top Cover Stitch Regulator Plunger Stop Ring
*147490	-----	Bed
NOTE: Due to the accuracy required for gear alignment, Bed cannot be supplied separately and can only be sent out as a unit, Arm and Bed assembled.		
143024	8287	Bed Hole Plug
143268	8287	Bed Leg (back)
1518(809)	8287	Bed Leg (back) Nut (2)
12431(819)	8276	Bed Slide
4307	8276	Bed Slide Spring
725(819)	8276	Bed Slide Spring Screw (2)
12432	8276	Bed Slide complete, Nos. 4307, 12431-(819) and two 725(819)
147477	8279	Bell Crank
147478	8279	Bell Crank Bracket
158(813)	8279	Bell Crank Bracket Screw (2)
140941(803)	8279	Bell Crank Hinge Screw
1650(819)	-----	Bell Crank Hinge Screw Nut
147479	-----	Bell Crank complete, Nos. 1650(819), 140941(803), 147477 and 147478
147469	-----	Combination of Feed and Stitch Regulator Parts, Nos. 143015, 143040, 143049, 143087, 143134, 147472 and 147473
147096	8280	Face Plate
147019	8280	Face Plate Gasket

No.	Plate	Name
152(809)	8280	Face Plate Screw (lower) (3)
738(809)	8280	Face Plate Screw (upper)
147470	8281	Feed Bar
147471	-----	Feed Bar 147470 with 147290, 147355, 147356, 272110 and two 1423(803)
147355	8281	Feed Bar Carrier with two each 158(805) and 140788(805)
158(805)	8281	Feed Bar Carrier Clamping Screw (2)
143031	8281	Feed Bar Carrier Oil Wick
143032	8281	Feed Bar Carrier Oil Wick Holder
147024	-----	Feed Bar Carrier Oil Wick Holder 143032 with 143031
228(805)	8281	Feed Bar Carrier Oil Wick Holder Screw (2)
272110	8281	Feed Bar Connecting Link
1423(803)	8281	Feed Bar Connecting Link Cap Screw (2)
147288	8281	Feed Bar Connecting Link Oil Wick
272111	8281	Feed Bar Connecting Link Oil Wick Clamp
147035	8281	Feed Bar Connecting Link Oil Wick Holder
50579(809)	8281	Feed Bar Connecting Link Oil Wick Holder Screw
147289	-----	Feed Bar Connecting Link Oil Wick Holder 147035 with 147288
147356	8281	Feed Bar Hinge Pin (eccentric)
140788(805)	8281	Feed Bar Hinge Pin Clamping Screw (2)
147315	8276	Feed Dog, 28 teeth (22 teeth to the inch)
50117(830)	8276	Feed Dog Screw (2)
147472	8269	Feed Eccentric with 1375(830) and two 1036(830)
1375(830)	8269	Feed Eccentric Body Position Screw
1036(830)	8269	Feed Eccentric Body Set Screw (2).....
140568(830)	8269	Feed Eccentric Stop Screw (8 stitch) ..
NOTE: No. 140568(830) is regularly furnished with this Machine.		
140256(830)	8269	Feed Eccentric Stop Screw (7 stitch)
140257(830)	8269	Feed Eccentric Stop Screw (5½ stitch)
140258(830)	8269	Feed Eccentric Stop Screw (14 stitch) ..
147473	8269	Feed Lifting Eccentric and Arm Shaft ~ (horizontal) Bevel Gear, right hand spiral with 1259(830), 140333(830) and 143088
NOTE: To ensure proper functioning of Gears, No. 147473 will not be supplied separately, but will be substituted by Pair of Gears No. 147476.		
140333(830)	8269	Feed Lifting Eccentric Position Screw
1259(830)	8269	Feed Lifting Eccentric Set Screw
147025	8281	Feed Lifting Rock Shaft

141151 10 stitches

No.	Plate	Name
147030	-----	Feed Lifting Rock Shaft Nos. 197(805), 140359(805), 143236, 147025, 147038, 147039, 147047 and two 147037
143052	8281	Feed Lifting Rock Shaft and Feed Rock Shaft Oil Wick Holder
197(805)	8281	Feed Lifting Rock Shaft and Feed Rock Shaft Oil Wick Holder Screw
147028	8281	Feed Lifting Rock Shaft Bushing (2)
447(830)	8281	Feed Lifting Rock Shaft Bushing Set Screw (2)
143039	8281	Feed Lifting Rock Shaft Cap
223(805)	8281	Feed Lifting Rock Shaft Cap Screw (2)..
147029	8281	Feed Lifting Rock Shaft Collar with two 460(830) (2)
460(830)	8281	Feed Lifting Rock Shaft Collar Set Screw (4)
143040	8269	Feed Lifting Rock Shaft Connecting Rod
140230(803)	8269	Feed Lifting Rock Shaft Connecting Rod Hinge Screw
1518(809)	8269	Feed Lifting Rock Shaft Connecting Rod Hinge Screw Nut
147474	8281	Feed Lifting Rock Shaft Crank (back) with 966(805)
966(805)	8281	Feed Lifting Rock Shaft Crank (back) Clamping Screw
147290	8281	Feed Lifting Rock Shaft Crank (front) with 140915(830)
140915(830)	8281	Feed Lifting Rock Shaft Crank (front) Clamping Screw
140359(805)	8281	Feed Lifting Rock Shaft Oil Plug Screw
143236	8281	Feed Lifting Rock Shaft Oil Plug Screw Washer (fiber)
147038	8281	Feed Lifting Rock Shaft Oil Wick (long)
147037	8281	Feed Lifting Rock Shaft Oil Wick (short) (2)
147039	8281	Feed Lifting Rock Shaft Oil Wick
147047	8281	Feed Lifting Rock Shaft Oil Wick Clamp- ing Plate
197(805)	8281	Feed Lifting Rock Shaft Oil Wick Clamp- ing Plate Screw
147040	8281	Feed Rock Shaft
147041	-----	Feed Rock Shaft Nos. 197(805), 140359- (805), 143236, 147039, 147040, 147046, 147047 and two 147045.....
147042	8281	Feed Rock Shaft Bushing (back)
447(830)	8281	Feed Rock Shaft Bushing (back) Set Screw
147043	8281	Feed Rock Shaft Bushing (front).....
447(830)	8281	Feed Rock Shaft Bushing (front) Set Screw

PARTS FOR MACHINE No. 251-11

No.	Plate	Name
143048	8281	Feed Rock Shaft Cap
223(805)	8281	Feed Rock Shaft Cap Screw (2)
147029	8281	Feed Rock Shaft Collar with two 460- (830)
460(830)	8281	Feed Rock Shaft Collar Set Screw (2)....
143049	8269	Feed Rock Shaft Connecting Rod
140230(803)	8269	Feed Rock Shaft Connecting Rod Hinge Screw
1518(809)	8269	Feed Rock Shaft Connecting Rod Hinge Screw Nut
147044	8281	Feed Rock Shaft Crank with 157(809)....
157(809)	8281	Feed Rock Shaft Crank Clamping Screw
140359(805)	8281	Feed Rock Shaft Oil Plug Screw
143236	8281	Feed Rock Shaft Oil Plug Screw Washer (fiber)
147046	8281	Feed Rock Shaft Oil Wick (long)
147045	8281	Feed Rock Shaft Oil Wick (short) (2)....
147039	8281	Feed Rock Shaft Oil Wick
147047	8281	Feed Rock Shaft Oil Wick Clamping Plate
197(805)	8281	Feed Rock Shaft Oil Wick Clamping Plate Screw
25878	8268	Guide (Accessories)
50190(819)	8268	Guide Thumb Screw (Accessories)
147139	8256	Machine Pulley, small rim diam., (disc power) "V" belt groove 2.9 in. with two 51283(830)
		NOTE: No. 147139 is regularly furnished.
51283(830)	8256	Machine Pulley Set Screw (2)
147140	8256	Machine Pulley large rim diam. (disc power) "V" belt groove 2.9 in. with two 51283(830)
147162	8282	Needle Bar (hollow) with 140239(830)....
143336	8282	Needle Bar Bushing (lower)
1133(830)	8282	Needle Bar Bushing (lower) Set Screw ..
52171	8282	Needle Bar Bushing (lower) Thread Eyelet
143324	8282	Needle Bar Bushing (upper)
1133(830)	8282	Needle Bar Bushing (upper) Set Screw ..
147492	8282	Needle Bar Connecting Link
147050	-----	Needle Bar Connecting Link 147492 with 143326
140231(803)	8282	Needle Bar Connecting Link Cap Screw
143056	8282	Needle Bar Connecting Link Roller Bearing (18)
143326	8282	Needle Bar Connecting Stud with 140706(803)
140706(803)	8282	Needle Bar Connecting Stud Clamping Screw
147053	8272	Needle Bar Connecting Stud Oil Wick

PARTS FOR MACHINE No. 251-11

No.	Plate	Name
143058	8282	Needle Bar Connecting Stud Slide Block
140542(830)	8269	Needle Bar Crank Position Screw
143196	8272	Needle Bar Oil Wick
140239(830)	8282	Needle Set Screw
146591	8231	Oil Flow Body.....
143061	8231	Oil Flow Body Gasket (2)
143062	8231	Oil Flow Window
143063	8231	Oil Flow Window Cap
50257(809)	8231	Oil Flow Window Cap Screw (4)
143370	8231	Oil Lead
51369(805)	8231	Oil Lead Screw
143064	8231	Oil Pipe for 147106
143384	8231	Oil Pipe for Oiling Rotating Hook Shaft (front) Bearing
143065	8231	Oil Pipe Clamping Sleeve
143066	8231	Oil Pipe Clamping Sleeve Nut
147106	8231	Oil Pipe complete from Oil Pipe to Arm Shaft (horizontal) Center Bearing, Nos. 143064, 143065 and 143066
143387	-----	Oil Pipe 143384 with 143124 for oiling Rotating Hook Shaft Front Bearing
143124	8231	Oil Pipe Clamping Sleeve
143125	8231	Oil Pipe Clamping Sleeve Nut
143126	8231	Oil Pipe Clamping Sleeve Nut Adaptor ..
143070	8231	Oil Pump (centrifugal) Body with 143126
143071	8231	Oil Pump (centrifugal) Body Position Pin (2)
157(805)	8231	Oil Pump (centrifugal) Body Screw (3) ..
143072	8231	Oil Pump (centrifugal) Cover
143073	8231	Oil Pump (centrifugal) Impeller
50123(805)	8269	Oil Pump (centrifugal) Impeller Locking Screw
143074	8231	Oil Pump (centrifugal) Screen
143075	8231	Oil Pump (centrifugal) Screen Frame
189(805)	8231	Oil Pump (centrifugal) Screen Frame Screw (4)
147107	8272	Oil Removing Wick (head end)
146745	8272	Oil Removing Wick (head end) Holder Body
147108	-----	Oil Removing Wick (head end) Holder Body 146745 with 146698 and 147107....
140553(805)	8272	Oil Removing Wick (head end) Holder Body Hinge Screw
146700	8272	Oil Removing Wick (head end) Holder Body Stop and Spring Clip
228(805)	8272	Oil Removing Wick (head end) Holder Body Stop and Spring Clip Screw
146698	8272	Oil Removing Wick (head end) Holder Body Spring

PARTS FOR MACHINE No. 251-11

No.	Plate	Name
147054	8272	Oil Removing Wick (head end) Hinge Plate and Cover
147055	8272	Oil Removing Wick (head end) Hinge Plate and Cover Gasket
1364(819)	8272	Oil Removing Wick (head end) Hinge Plate and Cover Screw (4)
147056	8272	Oil Removing Wick (head end) Holder Body complete, Nos. 228(805), 140553-(805), 146698, 146700, 146745, 147054, 147055 and 147107
147141	8269	Oil Wick, 11 in. long, for oiling Take-up Lever, Take-up Lever Link, Needle Bar Connecting Link and Thread Take-up Lever Link Hinge Bearing (2)
147143	8269	Oil Wick Holder with two 147141
140232(819)	8269	Oil Wick Holder Screw
143295	-----	Pair of Gears Nos. 143014 and 143081
147476	-----	Pair of Gears Nos. 143015 and 147473
147057	8285	Presser Bar (hollow)
147058	8285	Presser Bar Bushing (lower)
		NOTE: No. 143184 is used in place of No. 147058 when using Quilter or Finger Guards.
1133(830)	8285	Presser Bar Bushing (lower) Set Screw..
147392	8285	Presser Bar Guide Bracket with 50203-(830)
50203(830)	8285	Presser Bar Guide Bracket Clamping and Tension Releaser Screw
147060	8279	Presser Bar Lifter
69(850)	8279	Presser Bar Lifter Hinge Screw
147372	8285	Presser Bar Lifting Bracket
147027	8279	Presser Bar Lifting Lever with 448(830)
143108	8279	Presser Bar Lifting Lever Connecting Rod
1611(819)	8279	Presser Bar Lifting Lever Connecting Rod Nut
1611(819)	8279	Presser Bar Lifting Lever Connecting Rod Lock Nut
143191	8279	Presser Bar Lifting Lever Connecting Rod Oil Mist Retaining Disc (felt)
143109	8279	Presser Bar Lifting Lever Connecting Rod Swivel
802(819)	8279	Presser Bar Lifting Lever Hinge Screw
147373	8285	Presser Bar Lifting Lever Link
147062	8279	Presser Bar Lifting Lever Pin
448(830)	8279	Presser Bar Lifting Lever Pin Set Screw
146610	8279	Presser Bar Lifting Lever Spring
147291	8285	Presser Bar Spring
2070	8285	Presser Bar Spring Washer
62527	8276	Presser Foot Hinge Pin
147306	8276	Presser Foot Plate

PARTS FOR MACHINE No. 251-11

No.	Plate	Name
147307	8276	Presser Foot Shank
26231	8276	Presser Foot Spring
147308	8276	Presser Foot (spring hinged) complete, Nos. 26231, 62527, 147306 and 147307
140390(830)	8276	Presser Foot Screw
147091	8285	Pressure Regulating Thumb Screw and Presser Bar Guide
51614(809)	8285	Pressure Regulating Thumb Screw Lock Nut
143340	8286	Rotating Hook with 143301 and two 1253(830)
143341	8286	Rotating Hook 143340 with 143351, 270083 and four 1053(805)
143342	8286	Rotating Hook 143341 with 40274, 143346 and three 1367(805).....
143343	-----	Rotating Hook 143341 with 40274 and three 1367(805)
143344	8286	Rotating Hook 143342 with 52237
270010	8286	Rotating Hook Bobbin
52235	8286	Rotating Hook Bobbin Case
52236	-----	Rotating Hook Bobbin Case 52235 with 591(806), 1380(805) and 40394
40392	8286	Rotating Hook Bobbin Case Latch
125320	8286	Rotating Hook Bobbin Case Latch Lever
2974	8286	Rotating Hook Bobbin Case Latch Lever Fulcrum Pin
2975	8286	Rotating Hook Bobbin Case Latch Spring
592(805)	8286	Rotating Hook Bobbin Case Latch Stop Screw
40393	8286	Rotating Hook Bobbin Case Latch Hinge Nos. 2974, 40392 and 125320
591(806)	8286	Rotating Hook Bobbin Case Tension Regulating Screw
40394	8286	Rotating Hook Bobbin Case Tension Spring
1380(805)	8286	Rotating Hook Bobbin Case Tension Spring Screw
52237	8286	Rotating Hook Bobbin Case complete, Nos. 592(805), 2975, 40393 and 52236 ..
143346	8286	Rotating Hook Bobbin Case Holder
147475	8286	Rotating Hook Bobbin Case Holder Position Bracket
704(809)	8286	Rotating Hook Bobbin Case Holder Position Bracket Screw
140551(803)	8286	Rotating Hook Oil Flow Regulating Thumb Screw
143383	8286	Rotating Hook Oil Flow Regulating Thumb Screw Spring
233(805)	8286	Rotating Hook Oil Flow Regulating Thumb Screw Spring Screw

PARTS FOR MACHINE No. 251-11

No.	Plate	Name
143301	8286	Rotating Hook Oil Wick (felt)
40274	8286	Rotating Hook Section
1367(805)	8286	Rotating Hook Section Screw (3)
1253(830)	8286	Rotating Hook Set Screw (2)
143347	8286	Rotating Hook Shaft with 143350
147130	-----	Rotating Hook Shaft 143347 with 147131
143081	8286	Rotating Hook Shaft Bevel Gear (left hand Spiral) with two 1259(830)
NOTE: To ensure proper functioning of Gears, No. 143081 will not be supplied separately, but will be substituted by Pair of Gears No. 143295		
1259(830)	8286	Rotating Hook Shaft Bevel Gear Set Screw (2)
143082	8286	Rotating Hook Shaft Bushing (back)
140259(830)	8286	Rotating Hook Shaft Bushing (back) Set Screw
143382	8286	Rotating Hook Shaft Bushing (front)
1285(830)	8286	Rotating Hook Shaft Bushing (front) Set Screw
143042	8286	Rotating Hook Shaft Oil Filter Wick
143349	8286	Rotating Hook Shaft Oil Filter Wick Holder
143350	8286	Rotating Hook Shaft Oil Filter complete, Nos. 143042 and 143349
147131	8286	Rotating Hook Shaft Oil Retaining Collar with two 50429(830)
50429(830)	8286	Rotating Hook Shaft Oil Retaining Collar Set Screw (2)
270083	8286	Rotating Hook Thread Guard
1053(805)	8286	Rotating Hook Thread Guard Screw (4)
143351	8286	Rotating Hook Wiper
147166	8285	Slack Thread Regulator
190(809)	8285	Slack Thread Regulator Screw
147092	8256	Stitch Length Indicator Plate
402(819)	8256	Stitch Length Indicator Plate Screw
143085	8269	Stitch Regulator
143134	-----	Stitch Regulator 143085 with 140549(805), 143086 and 143378
143086	8269	Stitch Regulator Locking Slide
143087	8269	Stitch Regulator Locking Slide Ratchet Wheel
143088	8269	Stitch Regulator Locking Slide Ratchet Wheel Pin
143378	8269	Stitch Regulator Locking Slide Spring ..
140549(805)	8269	Stitch Regulator Locking Slide Spring Screw
2102	8274	Tension Disc (2)
1560(803)	8274	Tension Regulating Thumb Nut
1560(803)	8274	Tension Regulating Thumb Nut Lock Nut
147151	8274	Tension Releasing Disc

PARTS FOR MACHINE No. 251-11

No.	Plate	Name
147159	8274	Tension Releasing Lever Body
147160	-----	Tension Releasing Lever (adjustable) 147159 with 50123(819) and 147161
50123(819)	8274	Tension Releasing Lever (adjustable) Screw
147161	8274	Tension Releasing Lever Segment
12398	8274	Tension Releasing Lever Hinge Pin
12329	8274	Tension Releasing Lever Spring
32574	8274	Tension Releasing Pin
147152	8274	Tension Spring
140873(803)	8274	Tension Stud
147292	-----	Tension Stud 140873(803) with two 1560(803)
50305(803)	8274	Tension Stud Set Screw
147293	8274	Tension complete, Nos. 32574, 52083, 52394, 147151, 147152, 147292 and two 2102
147090	8274	Thread Eyelet (side of arm)
147069	8274	Thread Guard (side of arm)
52454	8274	Thread Retainer
624(830)	8274	Thread Retainer Set Screw
147386	-----	Thread Take-up Crank, Thread Take-up Lever with 147079 and Thread Take-up Lever Link with 147193 and eighteen 143056
147197	-----	Thread Take-up Crank, Thread Take-up Lever with 147079 and Thread Take-up Lever Link with 140231(803), 143058, 147193 and thirty-six 143056
147186	8282	Thread Take-up Crank, Thread Take-up Lever with 147079, Thread Take-up Lever Link and Thread Take-up Lever Link Hinge Stud complete, Nos. 147075 and 147197
140609(830)	8269	Thread Take-up Crank Clamping Screw
140610(819)	8269	Thread Take-up Crank Clamping Screw Hole Plug Screw
147070	8269	Thread Take-up Crank Clamping Screw Hole Plug Screw Gasket
1036(830)	8269	Thread Take-up Crank Set Screw
147193	8282	Thread Take-up Crank Wearing Plate ...
147156	8280	Thread Take-up Lever Guard
147077	8280	Thread Take-up Lever Guard Gasket ...
152(819)	8280	Thread Take-up Lever Guard Screw (2)..
147073	8282	Thread Take-up Lever Link Hinge Stud
147074	8282	Thread Take-up Lever Link Hinge Stud Oil Wick
435(830)	8282	Thread Take-up Lever Link Hinge Stud Set Screw
147075	-----	Thread Take-up Lever Link Hinge Stud 147073 with 147074

149/28
8017
35B3

PARTS FOR MACHINE No. 251-11

No.	Plate	Name
147078	8272	Thread Take-up Lever Oil Guard with 143196 and 147053
217(805)	8272	Thread Take-up Lever Oil Guard Screw
143056	8282	Thread Take-up Lever Roller Bearing (18)
147079	8282	Thread Take-up Lever Thread Eyelet Bushing
52394	8274	Thread Take-up Spring
52083	8274	Thread Take-up Spring Regulator with 50305(803)
448(830)	8274	Thread Take-up Spring Regulator Set Screw
147320(850)	8276	Throat Plate (small needle hole) for 147315, No. 54 Drill, No. 5 Needle Position, No. 14 or No. 16 Needle
		NOTE: Throat Plate No. 147320(850) is sent with this Machine unless otherwise specified.
691(850)	8276	Throat Plate Screw (2)

MACHINE NO. 251-12

FOR GENERAL STITCHING OPERATIONS ON LIGHT TO MEDIUM HEAVY WEIGHT FABRICS. HAS PENDANT LINK FEED MECHANISM. CLEARANCE UNDER PRESSER FOOT 5/16". NEEDLE BAR STROKE 1-13/64". MAXIMUM STITCH LENGTH 8 PER INCH.

This Machine is the same as the 251-11 Machine with the following exceptions:

No.	Plate	Name
147081	8270	Arm Shaft (horizontal) and Needle Bar Crank with 1036(830), 140542(830) and 140609(830), in place of 147003
147085	8273	Arm Side Shield, in place of 147007.....
147086	8273	Arm Side Shield complete, Nos. 16709, 147008 and 147085, in place of 147010
147163	8283	Needle Bar (hollow) in place of 147162
147164	-----	Needle Bar 147163 with 143386, for size 16 x 257 Needle
147113	8283	Needle Bar Bushing (lower) in place of 143336
147114	8283	Needle Bar Bushing (lower) Thread Eyelet, in place of 52171
143327	8283	Needle Bar Thread Guard for 143386
665(809)	8283	Needle Bar Thread Guard Screw for 143386
143386	-----	Needle Clamp 143328 with 665(809) and 143327
143328	8283	Needle Clamp with 140119(830) for 143386
140119(830)	8283	Needle Clamp Screw for 143328
147144	8270	Oil Wick Holder with two 147141, in place of 147143
147346(850)	8277	Throat Plate (small needle hole) for 147315, No. 54 Drill, No. 14 or No. 16 Needle, No. 2 Needle Position in place of 147320(850)

MACHINE NO. 251-13

FOR GENERAL STITCHING OPERATIONS ON LIGHT TO HEAVY WEIGHT FABRICS (3/8" PRESSER BAR LIFT) AND EXTRA HEAVY WEIGHT FABRICS (7/16" PRESSER BAR LIFT). HAS PENDANT LINK FEED MECHANISM. CLEARANCE UNDER PRESSER FOOT 3/8". NEEDLE BAR STROKE 1-7/16". MAXIMUM STITCH LENGTH 5-1/2 PER INCH.

This Machine is the same as the 251-11 Machine with the following exceptions:

No.	Plate	Name
147081	8271	Arm Shaft (horizontal) and Needle Bar Crank with 1036(830), 140542(830) and 140609(830), in place of 147003
147085	8273	Arm Side Shield, in place of 147007
147086	8273	Arm Side Shield complete, Nos. 16709, 147008 and 147085, in place of 147010
149174	8278	Feed Dog, 17 teeth (14 teeth to the inch) for 143175(850), in place of 147315
140257(830)	8271	Feed Eccentric Stop Screw (5½ stitch) in place of 140568(830)
147163	8284	Needle Bar (hollow) in place of 147162
147164	-----	Needle Bar 147163 with 143386, for size 16 x 257 and 16 x 261 Needles
147113	8284	Needle Bar Bushing (lower) in place of 143336
147114	8284	Needle Bar Bushing (lower) Thread Eyelet, in place of 52171
143327	8284	Needle Bar Thread Guard for 143386
665(809)	8284	Needle Bar Thread Guard Screw for 143386
143386	-----	Needle Clamp 143328 with 665(809) and 143327
143328	8284	Needle Clamp with 140119(830) for 143386
140119(830)	8284	Needle Clamp Screw for 143328
147145	8271	Oil Wick Holder with two 147141, in place of 147143
62527	8278	Presser Foot Hinge Pin for 127234
127233	8278	Presser Foot Plate for 127234
52390	8278	Presser Foot Shank for 127234
26231	8278	Presser Foot Spring for 127234
127234	8278	Presser Foot (spring hinged) complete, Nos. 26231, 52390, 62527 and 127233, in place of 147308
147387	-----	Thread Take-up Crank, Thread Take-up Lever with 147079 and Thread Take-up Lever Link with 147193 and eighteen 143056, in place of 147386

No.	Plate	Name
147198	-----	Thread Take-up Crank, Thread Take-up Lever with 147079 and Thread Take-up Lever Link with 140231(803), 143058, 147193 and thirty-six 143056, in place of 147197
147187	-----	Thread Take-up Crank, Thread Take-up Lever with 147079, Thread Take-up Lever Link and Thread Take-up Lever Link Hinge Stud complete, Nos. 147075 and 147198, in place of 147186
143175(850)	8278	Throat Plate (large needle hole) for 149174, in place of 147320(850)

FITTINGS
For Attaching Cuff
(Setting Cuff)
For No. 251-11 Machine

No.	Plate	Name
149031	8288	Feed Dog, 19 teeth (22 teeth to the inch)
18055	8288	Presser Foot Hinge Pin
143216	8288	Presser Foot Plate.....
143217	8288	Presser Foot Shank
143318	8288	Presser Foot Yielding Plate
143320	8288	Presser Foot Yielding Plate Spring.....
143219	8288	Presser Foot (hinged) long toes, with right hand Yielding Plate complete, Nos. 18055, 143216, 143217, 143318 and 143320
147336(850)	8288	Throat Plate (small needle hole) No. 54 Drill, No. 5 Needle Position, No. 14 or No. 16 Needle
147337	8288	Throat Plate Cuff Guide
665(809)	8288	Throat Plate Cuff Guide Screw
147338	8288	Throat Plate with Cuff Guide complete, Nos. 665(809), 147336 and 147337

For Banding
(Setting Collar Band)
For No. 251-11 Machine

No.	Plate	Name
147305	8289	Feed Dog, 28 teeth (22 teeth to the inch)
62527	8289	Presser Foot Hinge Pin
147325	8289	Presser Foot Plate
62926	8289	Presser Foot Shank
26231	8289	Presser Foot Spring
147326	8289	Presser Foot (spring hinged) complete, for 3/16 in., 7/32 in., and 1/4 in. margin, Nos. 26231, 62527, 62926 and 147325 ..
NOTE: When ordering No. 147326, state margin required.		
147309(850)	8289	Throat Plate (small needle hole) No. 54 Drill, No. 5 Needle Position, No. 14 or No. 16 Needle

For Basting
For No. 251-11 Machine

No.	Plate	Name
147305	8289	Feed Dog, 28 teeth (22 teeth to the inch)
62527	8289	Presser Foot Hinge Pin
147306	8289	Presser Foot Plate.....
147307	8289	Presser Foot Shank
26231	8289	Presser Foot Spring
147308	8289	Presser Foot (spring hinged) complete, Nos. 26231, 62527, 147306 and 147307
147309(850)	8289	Throat Plate (small needle hole) No. 54 Drill, No. 5 Needle Position, No. 14 or No. 16 Needle

For Beading or Center Stitching
For No. 251-11 Machine

No.	Plate	Name
160675	8290	Edge Guide
1443(809)	8290	Edge Guide Screw (2)
160676	8290	Edge Guide Shank
160677	8290	Edge Guide on Shank complete, Nos. 160675, 160676 and two 1443(809)
147327	8290	Feed Dog, 23 teeth (22 teeth to the inch)
160671	8290	Presser Foot Compensating Plate (left)
160672	8290	Presser Foot Compensating Plate (right)
1264(809)	8290	Presser Foot Hinge Screw (2).....
160673	8290	Presser Foot Shank
193252	8290	Presser Foot Spring (2)
160674	8290	Presser Foot (compensating, double) complete, Nos. 160671, 160672, 160673 and two each 1264(809) and 193252
147328(850)	8290	Throat Plate (large needle hole) No. 46 Drill, No. 5 Needle Position, from No. 16 to No. 22 Needle

**For Cuff Running
(Edgestitching Cuff)
For No. 251-11 Machine**

No.	Plate	Name
147305	8291	Feed Dog, 28 teeth (22 teeth to the inch)
62527	8291	Presser Foot Hinge Pin
147329	8291	Presser Foot Plate
702(830)	8291	Presser Foot Plate Adjusting Screw
1772(809)	8291	Presser Foot Plate Adjusting Screw Nut ..
147330	8291	Presser Foot Shank with 702(830) and 1772(809)
26231	8291	Presser Foot Spring
147331	8291	Presser Foot (spring hinged) complete, for 1/16 in. margin, Nos. 26231, 62527, 147329 and 147330
147309(850)	8291	Throat Plate (small needle hole) No. 54 Drill, No. 5 Needle Position, No. 14 or No. 16 Needle

**For Hem Collar Band
For No. 251-11 Machine**

No.	Plate	Name
147321	8291	Feed Dog, 15 teeth (22 teeth to the inch)
62527	8291	Presser Foot Hinge Pin
147322	8291	Presser Foot Plate
62926	8291	Presser Foot Shank
26231	8291	Presser Foot Spring
147323	8291	Presser Foot (spring hinged) complete, Nos. 26231, 62527, 62926 and 147322
147324(850)	8291	Throat Plate (small needle hole) No. 54 Drill, No. 5 Needle Position, No. 14 or No. 16 Needle

**For Interband Lining
For No. 251-11 Machine**

No.	Plate	Name
147315	8292	Feed Dog, 28 teeth (22 teeth to the inch)
140896(830)	8292	Presser Foot Hinge Screw
147316	8292	Presser Foot Plate
147317	8292	Presser Foot Shank
143320	8292	Presser Foot Yielding Plate Spring
147318	8292	Presser Foot Yielding Plate
147319	8292	Presser Foot (hinged) with right hand Yielding Plate complete, for 1/16 in. step, for 3/32 in. stitch margin and 3/8 in. mar- gin from center of needle to right hand side, Nos. 140896(830), 143320, 147316, 147317 and 147318
147320(850)	8292	Throat Plate (small needle hole) No. 54 Drill, No. 5 Needle Position, No. 14 or No. 16 Needle

**For Pants Seaming
For No. 251-12 Machine**

No.	Plate	Name
147315	8298	Feed Dog, 28 teeth (22 teeth to the inch)
62527	8298	Presser Foot Hinge Pin
147306	8298	Presser Foot Plate
147307	8298	Presser Foot Shank
26231	8298	Presser Foot Spring
147308	8298	Presser Foot (spring hinged) complete, Nos. 26231, 62527, 147306 and 147307.....
147388(850)	8298	Throat Plate (small needle hole) No. 52 Drill, No. 2 Needle Position, No. 19 Needle

For Pocket Setting
For No. 251-11 Machine

No.	Plate	Name
147315	8293	Feed Dog, 28 teeth (22 teeth to the inch)
140896(830)	8293	Presser Foot Hinge Screw
147332	8293	Presser Foot Plate
147333	8293	Presser Foot Shank
26231	8293	Presser Foot Spring
147334	8293	Presser Foot Yielding Plate
147335	8293	Presser Foot (hinged) with right hand Yielding Plate complete, for 1/16 in. step and 1/32 in. stitch margin, Nos. 26231, 140896(830), 147332, 147333 and 147334
140896(830)	8293	Presser Foot Hinge Screw
147378	8293	Presser Foot Plate
147333	8293	Presser Foot Shank
26231	8293	Presser Foot Spring
147379	8293	Presser Foot Yielding Plate
147380	8293	Presser Foot (hinged) with right hand Yielding Plate complete, for 1/16 in. step and 1/16 in. stitch margin, Nos. 26231, 140896(830), 147333, 147378 and 147379
140908(830)	8293	Presser Foot Hinge Screw
147381	8293	Presser Foot Plate
147382	8293	Presser Foot Shank
26231	8293	Presser Foot Spring
147379	8293	Presser Foot Yielding Plate
147383	8293	Presser Foot (hinged) with right hand Yielding Plate complete, for 1/16 in. step and 1/4 in. stitch margin, Nos. 26231, 140908(830), 147379, 147381 and 147382
147320(850)	8293	Throat Plate (small needle hole) No. 54 Drill, No. 5 Needle Position, No. 14 or No. 16 Needle

For Pocket Setting
For No. 251-12 Machine

No.	Plate	Name
147315	8299	Feed Dog, 28 teeth (22 teeth to the inch)
140896(830)	8299	Presser Foot Hinge Screw
147332	8299	Presser Foot Plate
147333	8299	Presser Foot Shank
26231	8299	Presser Foot Spring
147334	8299	Presser Foot Yielding Plate
147335	8299	Presser Foot (hinged) with right hand Yielding Plate complete, for 1/16 in. step and 1/32 in. stitch margin, Nos. 26231, 140896(830), 147332, 147333 and 147334
140896(830)	8299	Presser Foot Hinge Screw
147378	8299	Presser Foot Plate
147333	8299	Presser Foot Shank
26231	8299	Presser Foot Spring
147379	8299	Presser Foot Yielding Plate
147380	8299	Presser Foot (hinged) with right hand Yielding Plate complete, for 1/16 in. step and 1/16 in. stitch margin, Nos. 26231, 140896(830), 147333, 147378 and 147379
140908(830)	8299	Presser Foot Hinge Screw
147381	8299	Presser Foot Plate
147382	8299	Presser Foot Shank
26231	8299	Presser Foot Spring
147379	8299	Presser Foot Yielding Plate
147383	8299	Presser Foot (hinged) with right hand Yielding Plate complete, for 1/16 in. step and 1/4 in. stitch margin, Nos. 26231, 140908(830), 147379, 147381 and 147382
147346(850)	8299	Throat Plate (small needle hole) No. 54 Drill, No. 2 Needle Position, No. 14 or No. 16 Needle

For Running Collars

For No. 251-11 Machine

No.	Plate	Name
147305	8294	Feed Dog, 28 teeth (22 teeth to the inch)
62527	8294	Presser Foot Hinge Pin
147310	8294	Presser Foot Plate
147307	8294	Presser Foot Shank
26231	8294	Presser Foot Spring
147312	8294	Presser Foot (spring hinged) complete, for 3/16 in. margin, Nos. 26231, 62527, 147307 and 147310
147309(850)	8294	Throat Plate (small needle hole) No. 54 Drill, No. 5 Needle Position, No. 14 or No. 16 Needle

For Running Collars

For No. 251-12 Machine

No.	Plate	Name
147305	8298	Feed Dog, 28 teeth (22 teeth to the inch)
62527	8298	Presser Foot Hinge Pin
147306	8298	Presser Foot Plate
147307	8298	Presser Foot Shank
26231	8298	Presser Foot Spring
147308	8298	Presser Foot (spring hinged) complete, Nos. 26231, 62527, 147306 and 147307
147374(850)	8298	Throat Plate (small needle hole) No. 54 Drill, No. 2 Needle Position, No. 14 or No. 16 Needle

For Sleeve Binding

For No. 251-11 Machine

No.	Plate	Name
149603	8295	Feed Dog, 20 teeth (16 teeth to the inch)
26606	8295	Throat Plate
151435	-----	Puller Feed Device complete, Nos. 147344, 150733 and 151434

NOTE: For component parts of Puller Feed Device complete No. 151435, see Page No. 30

For Sleeve Plackets

For No. 251-11 Machine

No.	Plate	Name
147315	8294	Feed Dog, 28 teeth (22 teeth to the inch)
147369	8294	Presser Foot Compensating Plate (left)
147370	8294	Presser Foot Compensating Plate (right)
160673	8294	Presser Foot Shank
140904(830)	8294	Presser Foot Shank Hinge Screw (2)
193252	8294	Presser Foot Spring (2)
147371	8294	Presser Foot (spring hinged) complete, Nos. 147369, 147370, 160673 and two each 140904(830) and 193252
147320(850)	8294	Throat Plate (small needle hole) No. 54 Drill, No. 5 Needle Position, No. 14 or No. 16 Needle

For Sleeve Plackets

For No. 251-12 Machine

No.	Plate	Name
147315	21251	Feed Dog, 28 teeth (22 teeth to the inch)
147369	21251	Presser Foot Compensating Plate (left)
147370	21251	Presser Foot Compensating Plate (right)
160673	21251	Presser Foot Shank
140904(830)	21251	Presser Foot Shank Hinge Screw (2)
193252	21251	Presser Foot Spring (2)
147371	21251	Presser Foot (spring hinged) complete, Nos. 147369, 147370, 160673 and two each 140904(830) and 193252
147346(850)	21251	Throat Plate (small needle hole) No. 54 Drill, No. 2 Needle Position, No. 14 or No. 16 Needle

For First Shoulder Joining

For No. 251-11 Machine

No.	Plate	Name
149057	8296	Feed Dog, 21 teeth (22 teeth to the inch)
62527	8296	Presser Foot Hinge Pin
147339	8296	Presser Foot Plate
62926	8296	Presser Foot Shank
26231	8296	Presser Foot Spring
147340	8296	Presser Foot (spring hinged) complete, for 1/4 in. margin, Nos. 26231, 62527, 62926 and 147339
142060(850)	8296	Throat Plate (small needle hole) No. 53 Drill, No. 5 Needle Position, No. 18 Needle

For Second Shoulder Joining

and Stitching Down Collar

For No. 251-11 Machine

No.	Plate	Name
149057	8296	Feed Dog, 21 teeth (22 teeth to the inch)
18055	8296	Presser Foot Hinge Pin
143216	8296	Presser Foot Plate
143217	8296	Presser Foot Shank
143318	8296	Presser Foot Yielding Plate
143320	8296	Presser Foot Yielding Plate Spring.....
143219	8296	Presser Foot (hinged) long toes with right hand Yielding Plate complete, Nos. 18055, 143216, 143217, 143318 and 143320
142060(850)	8296	Throat Plate (small needle hole) No. 53 Drill, No. 5 Needle Position, No. 18 Needle

For Top Stitch Collars

(Edgestitching)

For No. 251-11 Machine

No.	Plate	Name
149137	8297	Feed Dog, 1/8 in. stitch (22 teeth to the inch) 8 teeth front and 5 teeth back of needle
62527	8297	Presser Foot Hinge Pin
147313	8297	Presser Foot Plate
62926	8297	Presser Foot Shank
26231	8297	Presser Foot Spring
147314	8297	Presser Foot (spring hinged) complete, for 3/32 in. margin, Nos. 26231, 62527, 62926 and 147313
143278(850)	8297	Throat Plate (small needle hole)

For Top Stitching Slash Pockets

on Ivy League Pants

For No. 251-11 Machine

No.	Plate	Name
147315	8297	Feed Dog, 28 teeth (22 teeth to the inch)
26276	8297	Presser Foot Hinge Pin
147347	8297	Presser Foot Plate
702(830)	8297	Presser Foot Plate Adjusting Screw.....
1772(809)	8297	Presser Foot Plate Adjusting Screw Nut
147348	8297	Presser Foot Shank with 702(830) and 1772(809)
26231	8297	Presser Foot Spring
147349	8297	Presser Foot (spring hinged) complete, Nos. 26231, 26276, 147347 and 147348
147320(850)	8297	Throat Plate (small needle hole) No. 54 Drill, No. 5 Needle Position, No. 14 or No. 16 Needle

For Top Stitching Slash Pockets
on Ivy League Pants

For No. 251-12 Machine

No.	Plate	Name
147315	21251	Feed Dog, 28 teeth (22 teeth to the inch)
26276	21251	Presser Foot Hinge Pin
147347	21251	Presser Foot Plate
702(830)	21251	Presser Foot Plate Adjusting Screw
1772(809)	21251	Presser Foot Plate Adjusting Screw Nut
147348	21251	Presser Foot Shank with 702(830) and 1772(809)
26231	21251	Presser Foot Spring
147349	21251	Presser Foot (spring hinged) complete, Nos. 26231, 26276, 147347 and 147348
147346(850)	21251	Throat Plate (small needle hole) No. 54 Drill, No. 2 Needle Position, No. 14 or No. 16 Needle

PULLER FEED DEVICE COMPLETE No. 151435

No.	Plate	Name
146973	21253	Driving Pulley (auxiliary)
647(819)	21253	Driving Pulley (auxiliary) Set Screw (3)
147343	21253	Machine Pulley, small rim diameter (disc power) "V" belt groove (outside diameter of belt groove 2.9 in.) with two 51283(830)
147344	-----	Machine Pulley with Driving Pulley (auxiliary) complete, Nos. 146973, 147343 and three 647(819)
51283(830)	21253	Machine Pulley Set Screw (2)
151424	21252	Puller Feed Base with 200364(803), 259061 end two each 200902(804) and 205796
259074	21252	Pulley Feed Base Block
200710	21252	Puller Feed Base Bolt (2)
9842	21252	Puller Feed Base Bolt Washer (2)
150733	21253	Puller Feed Driving Belt 33 in. outside length for "V" Drive
259056	21252	Puller Feed Driving Gear with 200394- (803)
270229	21252	Puller Feed Driving Gear and Pinion ..
1463(806)	-----	Puller Feed Driving Gear and Pinion Screw

Puller Feed Device complete No. 151435

(Continued)

No.	Plate	Name
200394(803)	21252	Pulley Feed Driving Gear Set Screw
259057	21252	Puller Feed Driving Pinion
259468	21252	Puller Feed Driving Pulley with 200373(803)
1463(806)	-----	Puller Feed Driving Pulley Screw
200373(803)	-----	Puller Feed Driving Pulley Set Screw....
151425	21252	Puller Feed Idler Gear
151426	21252	Puller Feed Idler Gear Bracket and Driving Pulley Shaft
151427	21252	Puller Feed Idler Gear Bracket and Driving Pulley Shaft Collar
155(805)	-----	Puller Feed Idler Gear Bracket and Driving Pulley Shaft Screw
200364(803)	21252	Puller Feed Idler Gear Bracket and Driving Pulley Shaft Set Screw
140897(803)	21252	Puller Feed Idler Gear Hinge Screw
151428	21252	Puller Feed Roll (lower, 3-1/2 in. long) with 453(830)
453(830)	21252	Puller Feed Roll (lower) Set Screw
151429	21252	Puller Feed Roll (lower) Shaft
151430	21252	Puller Feed Roll (lower) Shaft 151429 with 151428
151431	21252	Puller Feed Roll (upper) with 453(830)..
453(830)	21252	Puller Feed Roll (upper) Set Screw
151432	21252	Puller Feed Roll (upper) Shaft
151433	-----	Puller Feed Roll (upper) Shaft 151432 with 151431
*259061	-----	Puller Feed Roll (upper) Shaft Bearing
200902(804)	21252	Puller Feed Roll (upper) Shaft Bearing Screw (2)
205796	21252	Puller Feed Roll (upper) Shaft Bearing Spring (2)
270233	-----	Puller Feed Roll (upper) Shaft Collar....
259063	21252	Puller Feed Roll Shaft Gear with 200394(803) (2)
200394(803)	21252	Puller Feed Roll Shaft Gear Set Screw (2)
151434	21252	Puller Feed Device Nos. 155(805), 140897(803), 151424, 151425, 151426, 151427, 151430, 151433, 259056, 259057, 259074, 259468, 270229, 270233 and two 1463(806), 9842, 200710 and 259063
151435	-----	Puller Feed Device complete, for sleeve binding, Nos. 147344, 150733 and 151434

ACCESSORIES

No.	Plate	Name
270010	8286	Bobbin (2)
143308	8268	Machine Base and Oil Reservoir Cushion (4)
12361	8268	Machine Hinge Connection (2)
41400	8268	Machine Rest Pin (wood)
121741	8268	One Quart Can filled with light grade stainless oil
228476	8268	Screw Driver
120440	8268	Screw Driver
259477	8268	Screw Driver 5 in. long
146057	8268	Wrench (socket) for 140609(830)
		NOTE: No. 146057 is not regularly furnished.
8908	8268	Wrench
		NOTE: No. 8908 is not regularly furnished.
11140	8268	Wrench
		NOTE: No. 11140 is not regularly furnished.

BOBBIN WINDER NO. 259462

(Swinging Automatic, Right Hand)

for "V" Belt Drive

No.	Plate	Name
259428	23253	Brake (leather)
259429	23253	Brake Clamp
200113(806)	23253	Brake Clamp Screw
225453	23253	Frame with 202277 and 259660
225454	23253	Frame Hinge Pin
202277	23253	Frame Oil Packing (wick)
259660	23253	Frame Oil Well Washer
225455	23253	Frame Spring
225456	23253	Frame Spring Plunger
259461	23253	Pulley with 200380(803)
200380(803)	23253	Pulley Set Screw
225381	23253	Spindle
225444	23253	Stop Latch
200056(805)	23253	Stop Latch Screw
225458	23253	Stop Latch Thumb Lever
225459	23253	Stop Latch Thumb Lever Hinge Stud
225459	23253	Stop Latch Thumb Lever Joint Stud
202478	23253	Stop Latch Trip Lever
200299(819)	23253	Stop Latch Trip Lever Hinge Screw

BOBBIN WINDER NO. 259462

(Swinging Automatic, Right Hand)

For "V" Belt Drive

(Continued)

No.	Plate	Name
225461	23253	Tension Bracket with 201499(819).....
200082(804)	23253	Tension Bracket Screw
228026	23253	Tension Bracket Screw Washer
2102	23253	Tension Disc (2)
13710	23253	Tension Spring
201499(819)	23253	Tension Stud
201572(819)	23253	Tension Stud Thumb Nut
225462	23253	Bobbin Winder Tension Bracket complete Nos. 13710, 201572(819), 225461 and two 2102
259662	23253	Bobbin Winder and Tension Bracket Base
259462	23253	Bobbin Winder complete, for "V" belt, Nos. 200056(805), 200082(804), 200113(806), 200299(819), 202478, 225381, 225444, 225453, 225454, 225455, 225456, 225458, 225462, 228026, 259428, 259429, 259461, 259662, two each 225459 and wood screws 3/4 in. No. 12 R.H.B.

KNEE LIFTER PARTS

No.	Plate	Name
147480	21255	Bell Crank Plunger
143280	21254	Rock Shaft
147481	-----	Rock Shaft 143280 with 147482, 147483 and 147485
147482	21254	Rock Shaft Crank with 140351(830) and 143282
140350(830)	21254	Rock Shaft Crank Adjusting Screw
143282	-----	Rock Shaft Crank Adjusting Screw 140350(803) with 51649(809)
51649(809)	21254	Rock Shaft Crank Adjusting Screw Lock Nut
140351(830)	21254	Rock Shaft Crank Clamping Screw
147487	21254	Rock Shaft Knee Arm
147489	21254	Rock Shaft Knee Arm Hub with 140351- (830) and 140737(803)

KNEE LIFTER PARTS

(Continued)

No.	Plate	Name
140351(830)	21254	Rock Shaft Knee Arm Hub Clamping Screw
140737(803)	21254	Rock Shaft Knee Arm Set Screw
147488	-----	Rock Shaft Knee Arm complete, Nos. 2767, 147487 and 147489
2767	21254	Rock Shaft Knee Arm Plate with 356(803)
356(803)	21254	Rock Shaft Knee Arm Plate Set Screw ..
147485	21254	Rock Shaft Spring
147483	21254	Rock Shaft Stop Dog with 140351(830) ..
140351(830)	21254	Rock Shaft Stop Dog Clamping Screw ..
147484	21254	Rock Shaft complete, Nos. 147481 and 147488.....

MACHINE BASE AND OIL RESERVOIR

No.	Plate	Name
147491	21255	Machine Base and Oil Reservoir
143257	21255	Machine Base and Oil Reservoir Gasket (cork)
50741(805)	21255	Machine and Machine Base and Oil Reservoir Screw (for shipping purposes only)
140343(805)	21255	Machine and Machine Base and Oil Reservoir Screw Hole Plug Screw
143359	21255	Machine Base and Oil Reservoir Screw Retainer (for shipping purposes only)
143360	21255	Machine Base and Oil Reservoir Screw Cotter Pin (for shipping purposes only)

THREAD UNWINDER

For Two Spools or Two Large Cones of Thread

No.	Plate	Name
228764	24193	Spool Pin (2)
228766	24193	Spool Rest with 201254(803)
150203	24193	Spool Rest Cushion (felt) (2)
228767	24193	Spool Rest Rod
201254(803)	24193	Spool Rest Set Screw
228768	24193	Spool Stand

THREAD UNWINDER

For Two Spools or Two Large Cones of Thread

(Continued)

No.	Plate	Name
228769	24193	Thread Guide (2)
228770	24193	Thread Guide Holder
228774	24193	Thread Guide Rod
228776	24193	Thread Unwinder complete, for two spools Nos. 228766, 228767, 228768, 228770, 228774, two each 150203, 228764, 228769 and three wood screws 7/8 in. No. 12
27739	-----	Thread Cone (wood) for large cones
225390	-----	Thread Cone Holder, for inverted cones

NOTE: No. 27739 and 225390 are used with, but not included in 228776

8231-1/2

147106

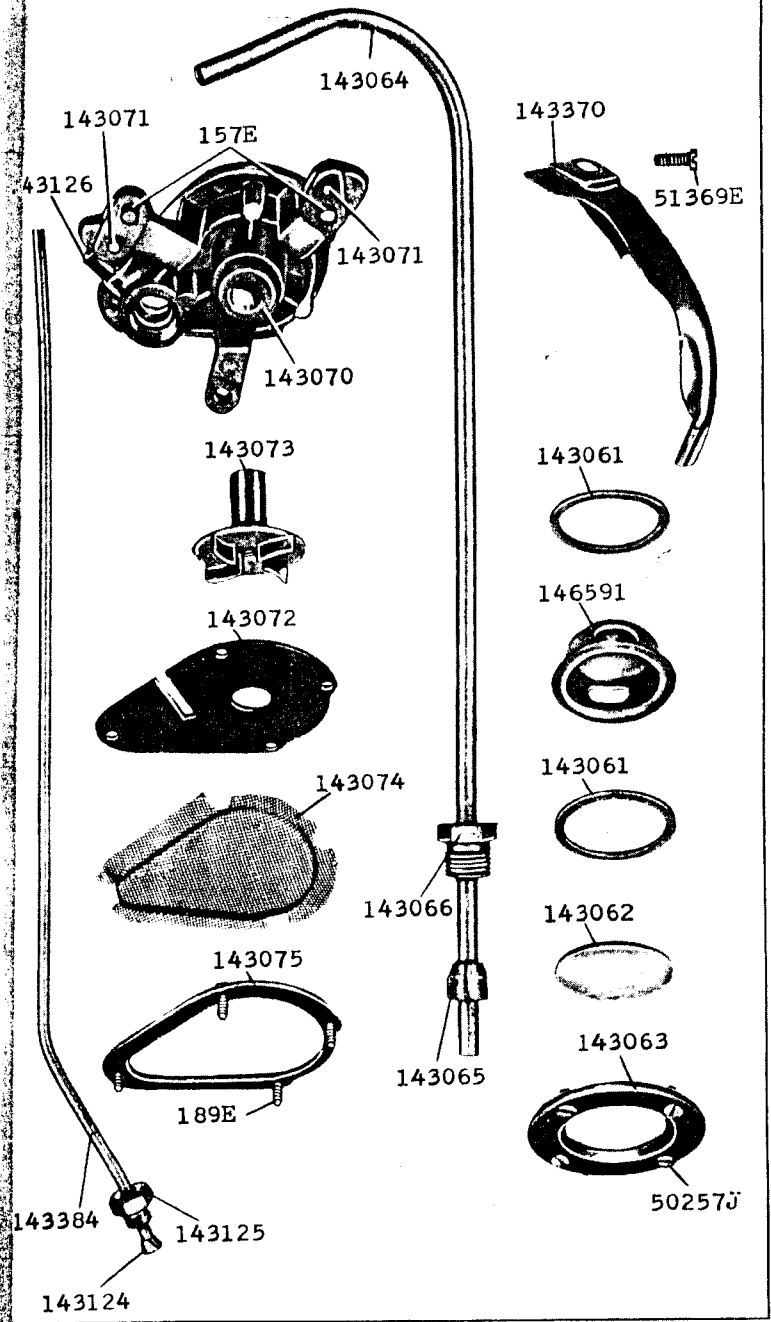

8256-1/2

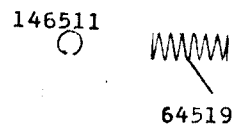
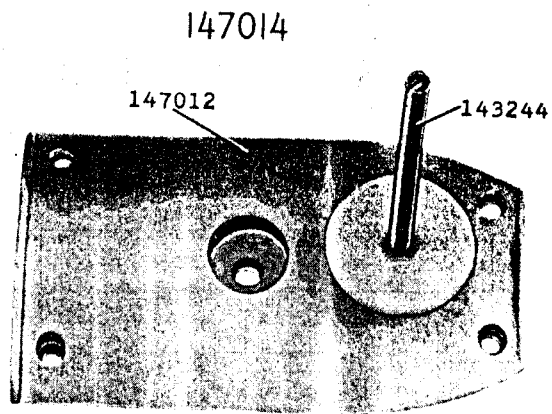
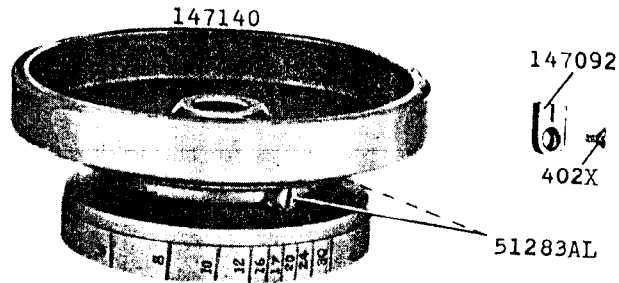
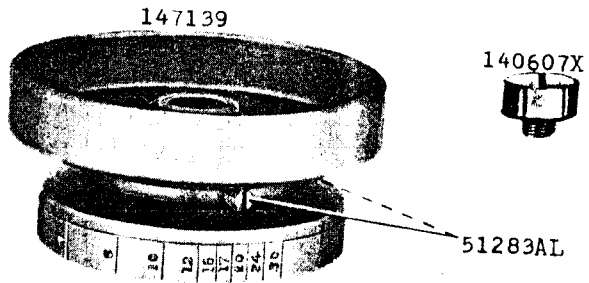

8268-1/2

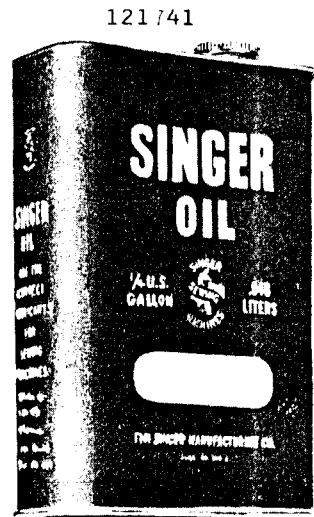

228476

259477

120440

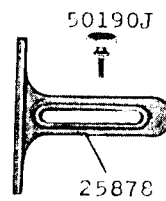
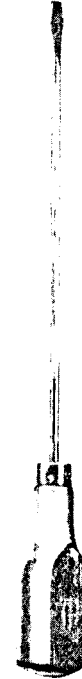

12361



143308

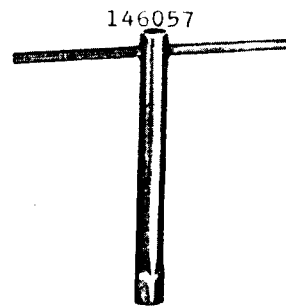

8908

11140

41400



8269-1/3

251-II

8270-1/3

251-I2

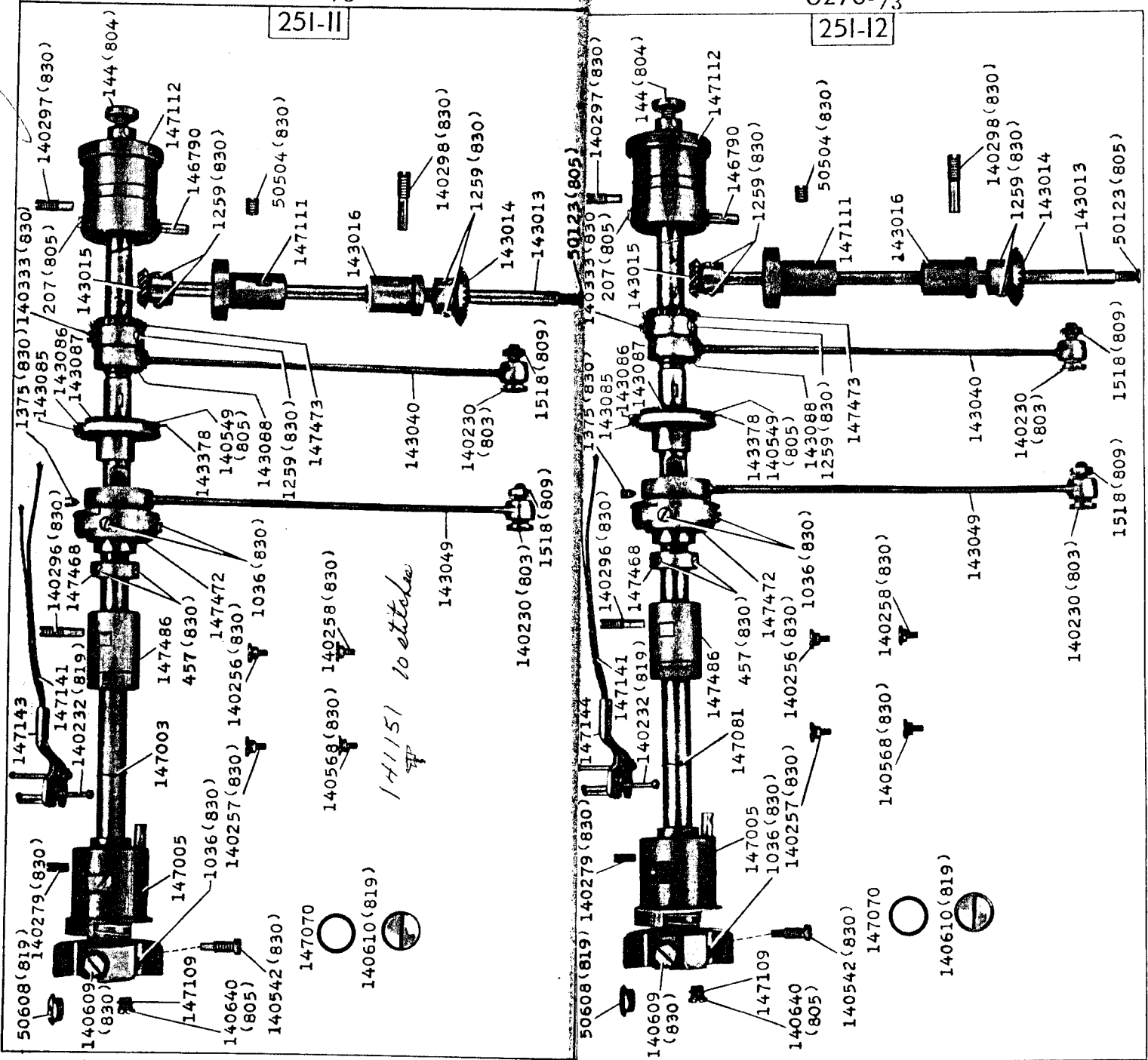

8273-1/2

251-12 251-13

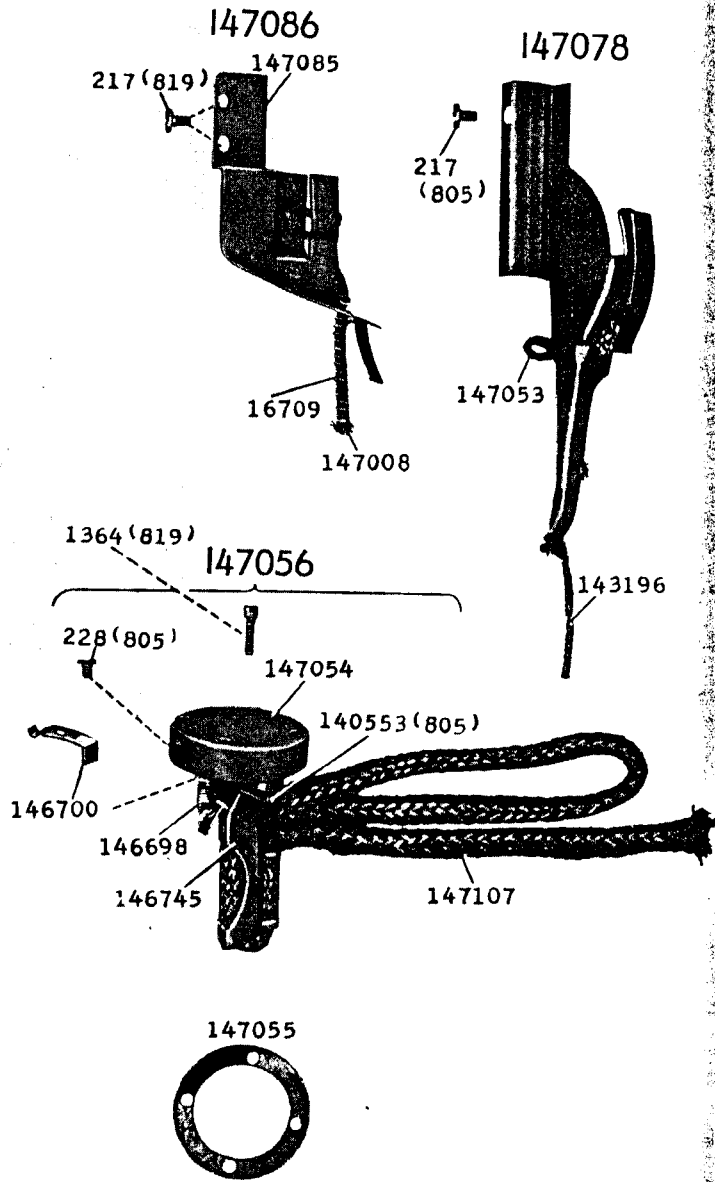

8274-2/3

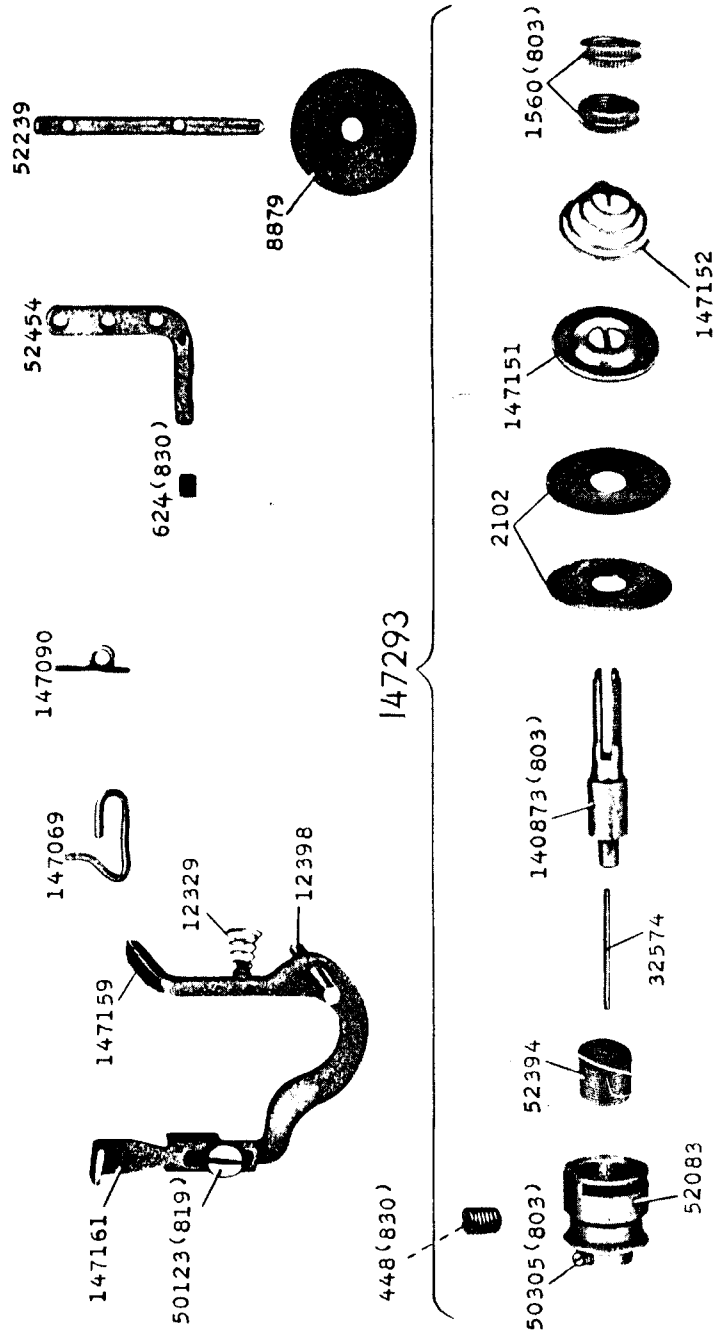

8275-2/3

8276-2/3

251-II

147015

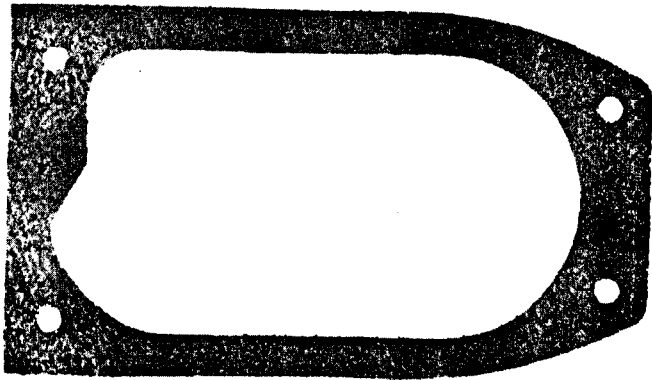

51369 (813)



147013

147011

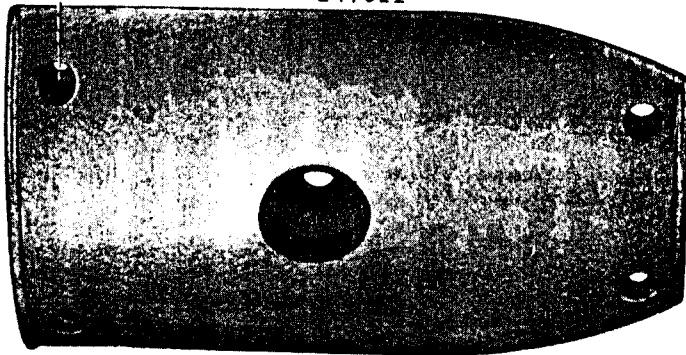

146511



64519



147105

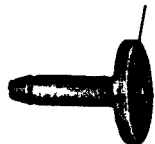

60117 (830)



147315



22=1

147320 (850)

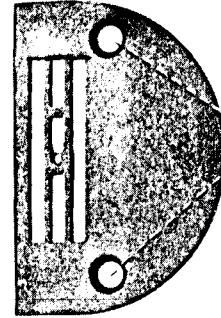

691 (850)



147308

140390 (830)



26231

147307

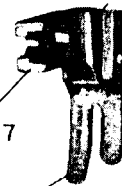

62527

147306

12432

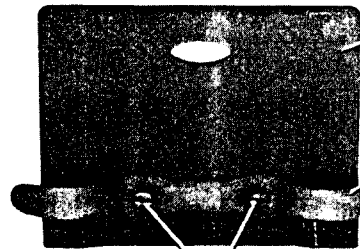

12431 (819)

4307

725 (819)

8277-2/3

251-12

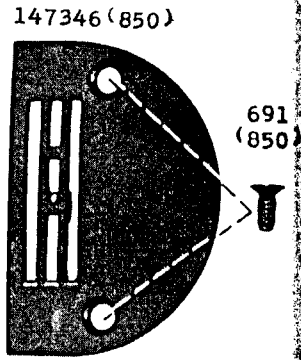
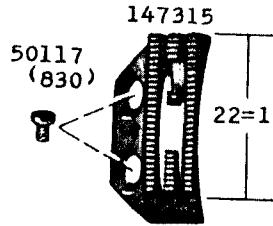

147308

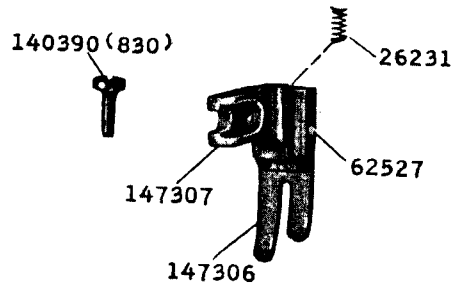

12432

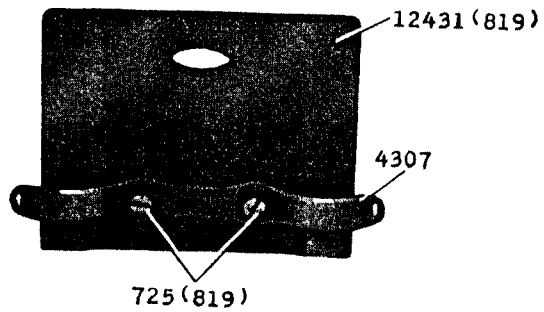

8278-2/3

251-13

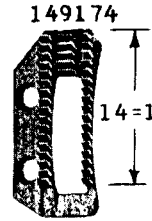
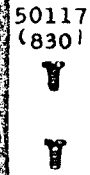

143175 (850)

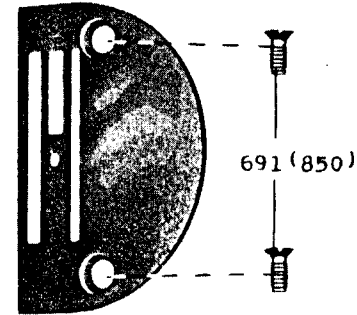

127234

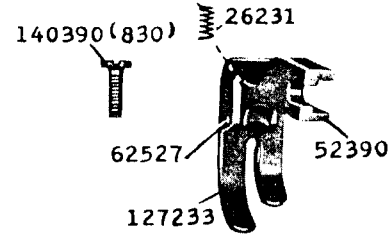

12432

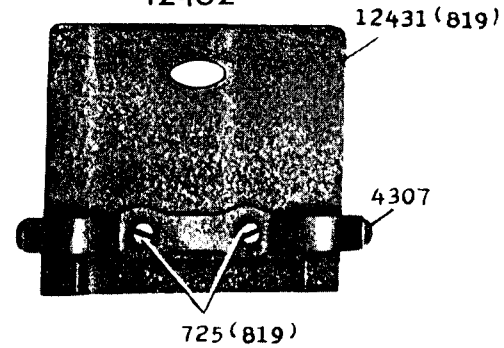

8279-1/2

8280-1/2

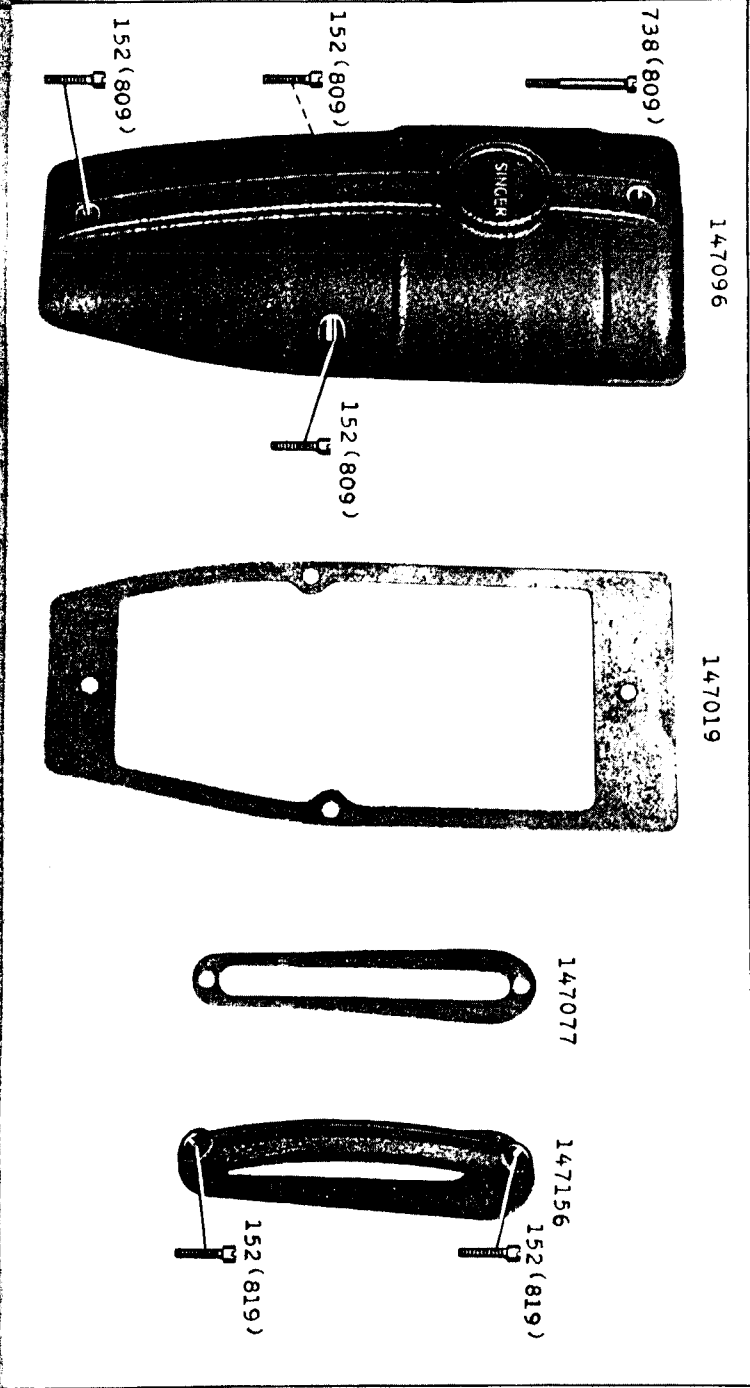
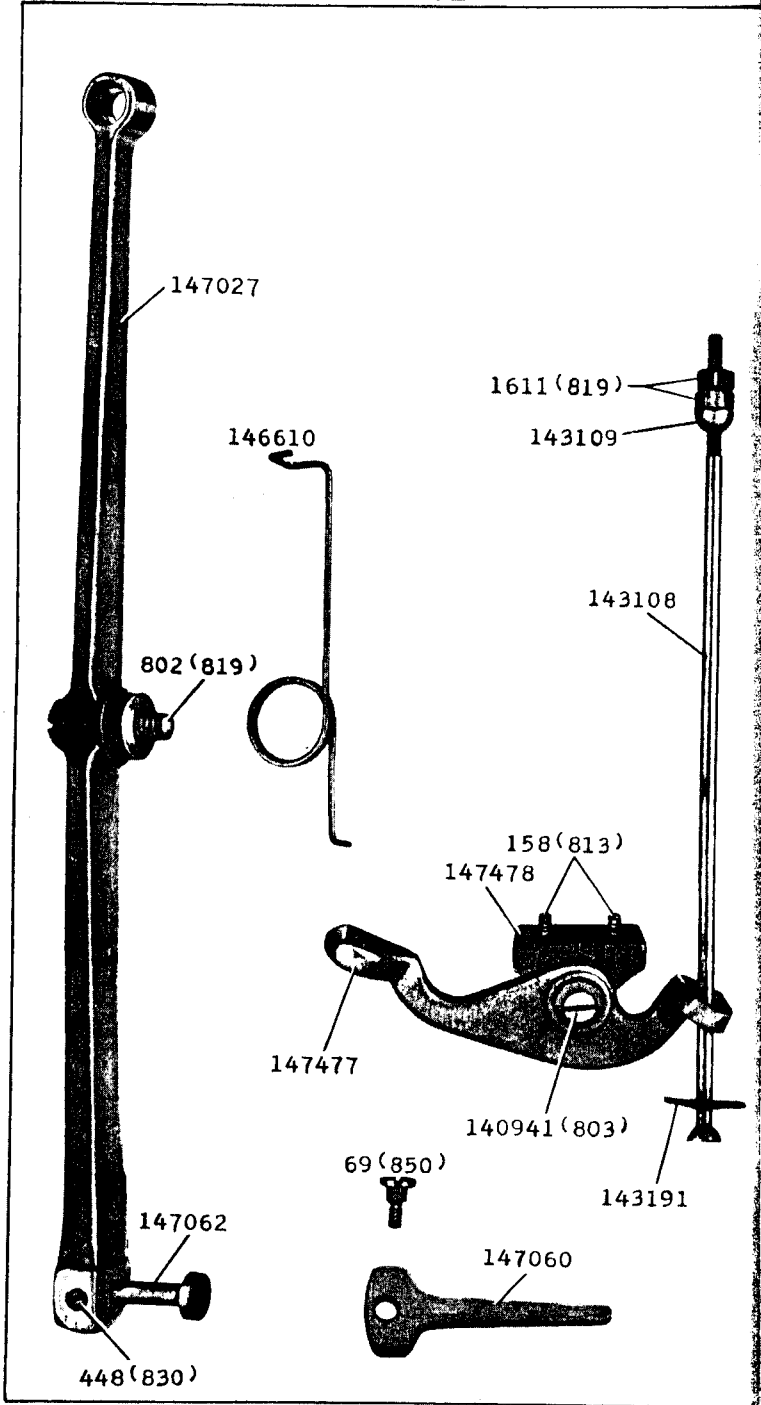

8281-1/3

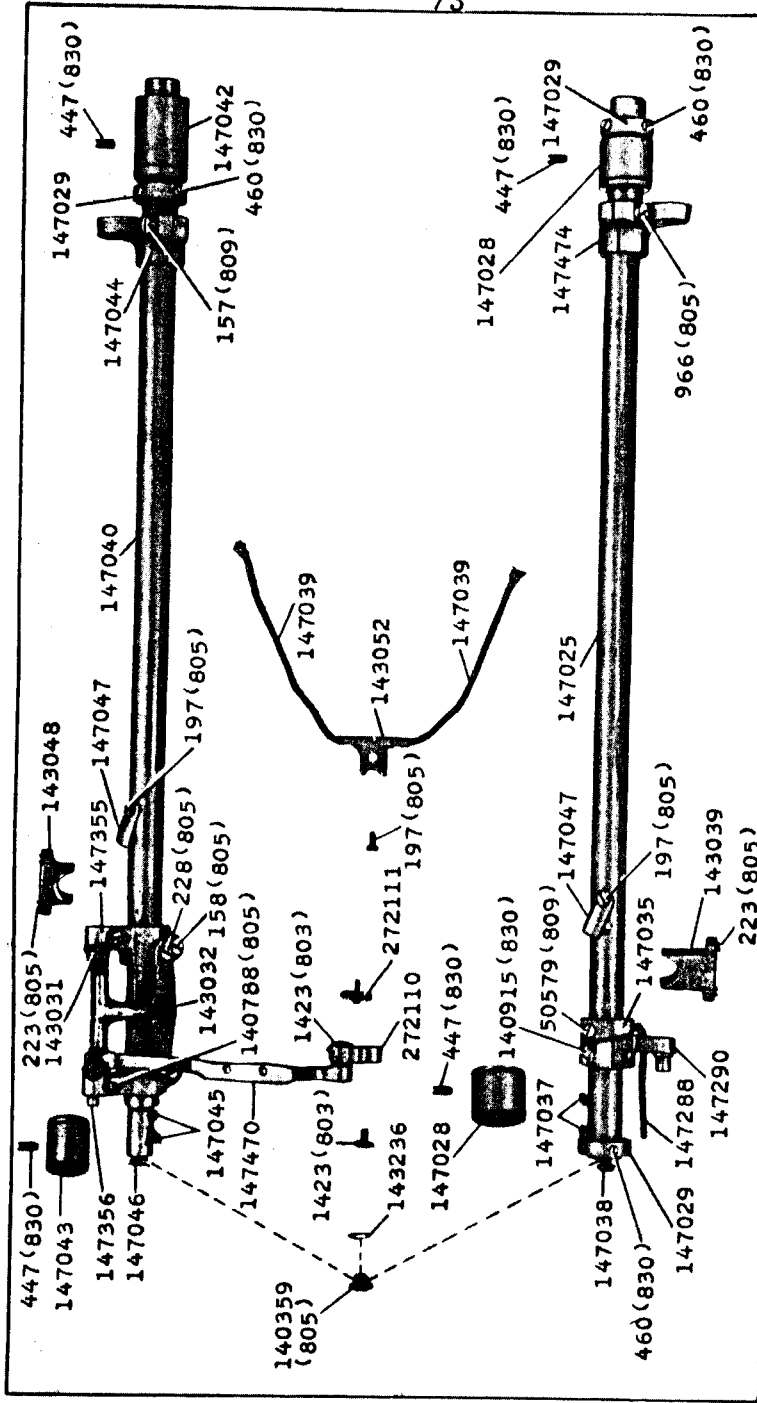

8282-2/3

251-II

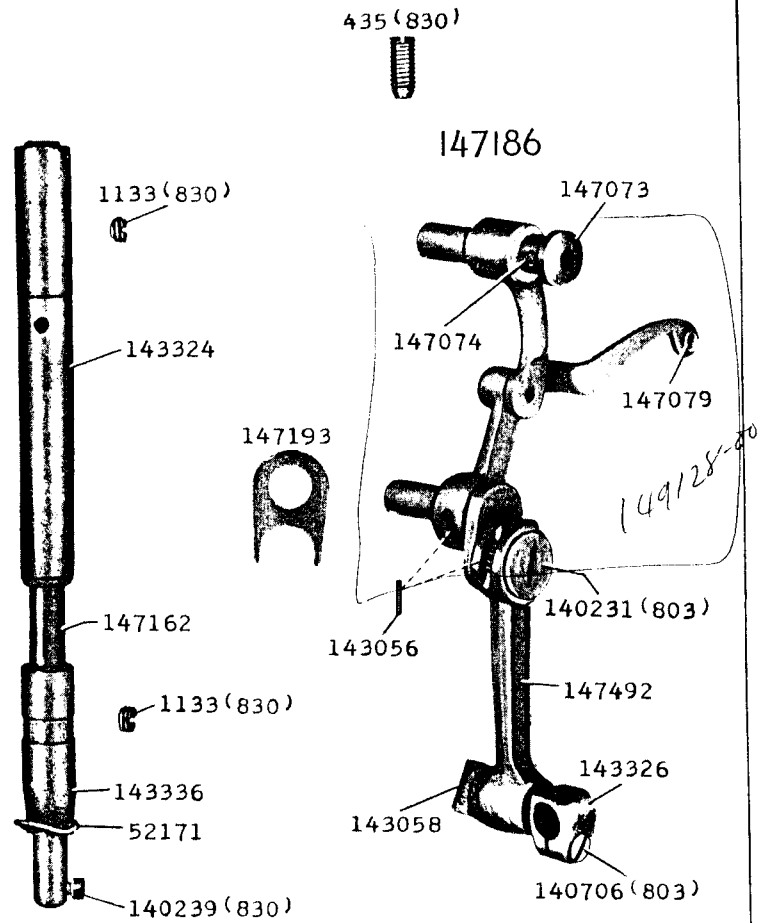

*Readlers screw
in place of
140239 use 600*

8283-2/3

251-12

435 (830)



147186

1133 (830)

147073

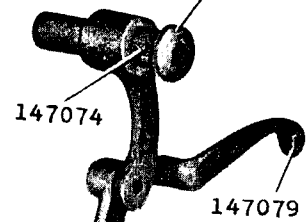

147074

147079

143324

147193



147163

143056

140231 (803)

147113

147492

1133 (830)

147114

143326

665 (809)

143058

140119 (830)

140706 (803)

143327

143328

8284-2/3

251-13

435 (830)



147187

1133 (830)

147073

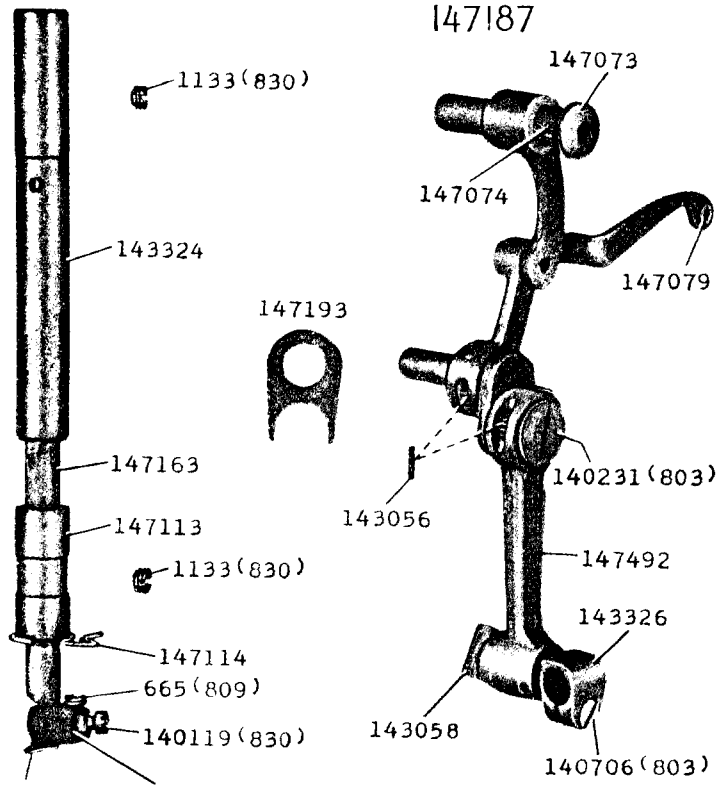

147074

147079

143324

147193



147163

143056

140231 (803)

147113

147492

1133 (830)

147114

143326

665 (809)

143058

140119 (830)

140706 (803)

143327

143328

8285-2/3

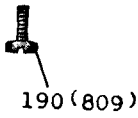
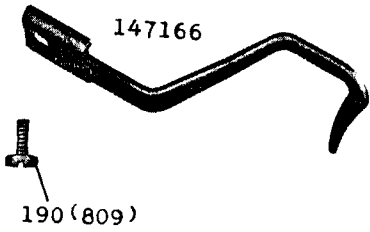
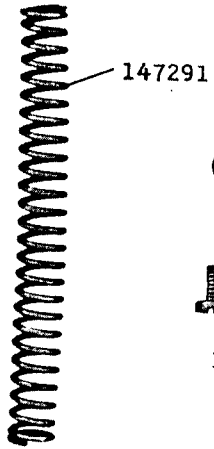
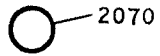
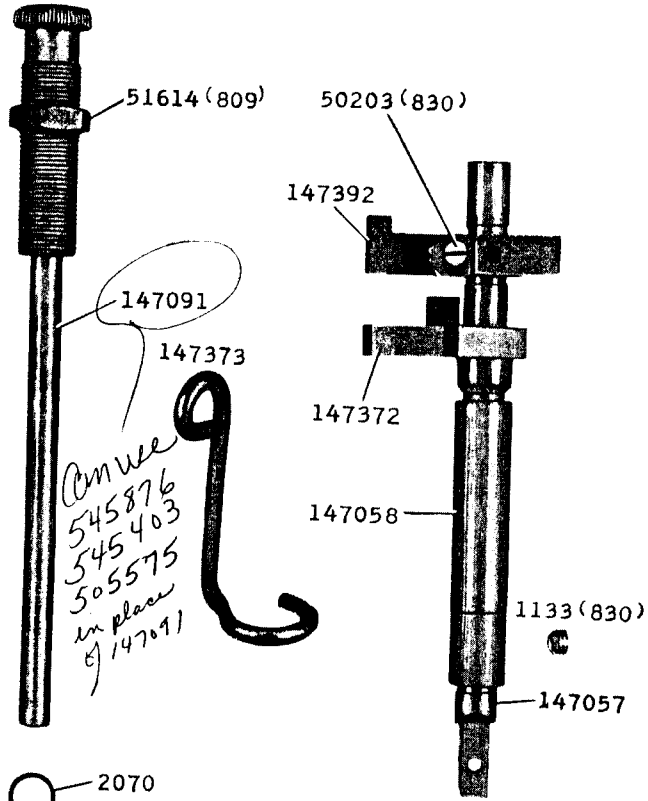

*Am we
545876
545403
505575
in place
of 147091*

8286-1/2

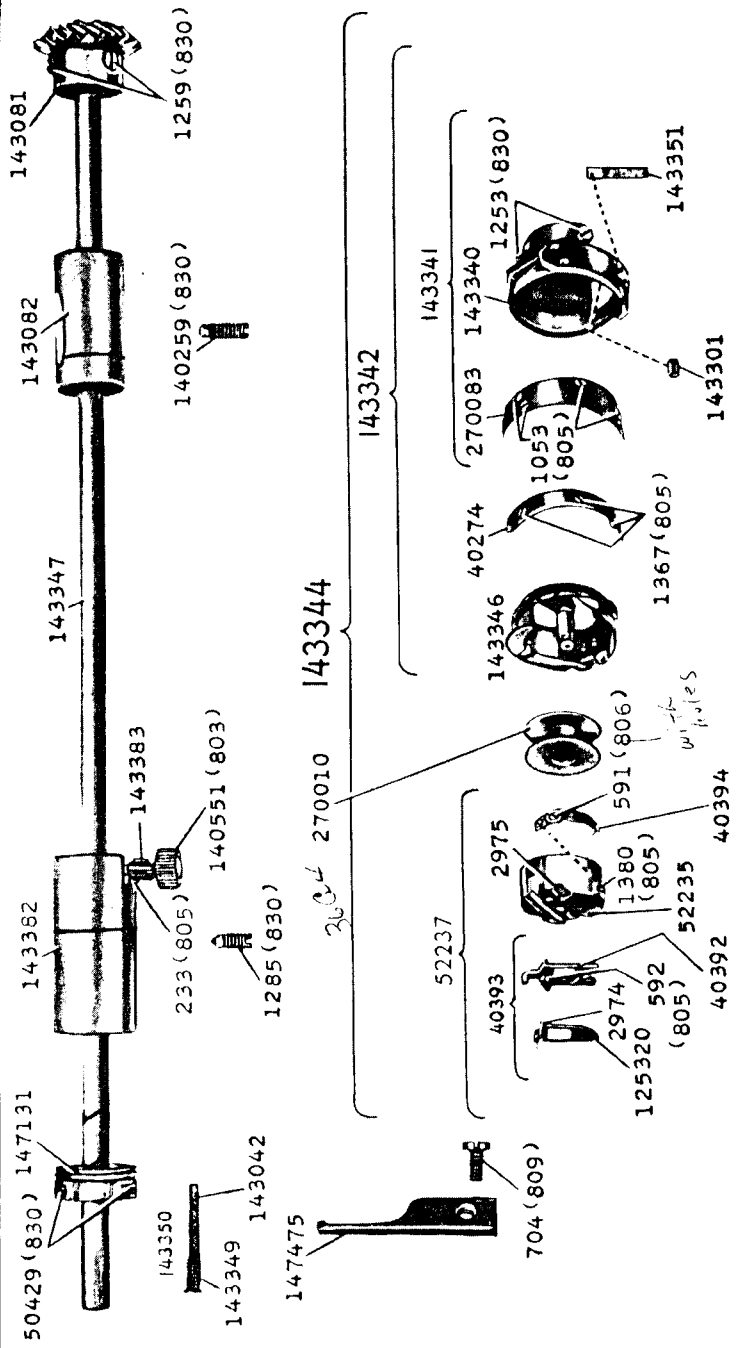

*with
wheels*

8287-2/3

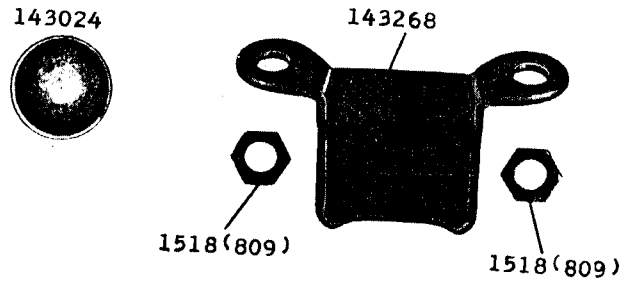
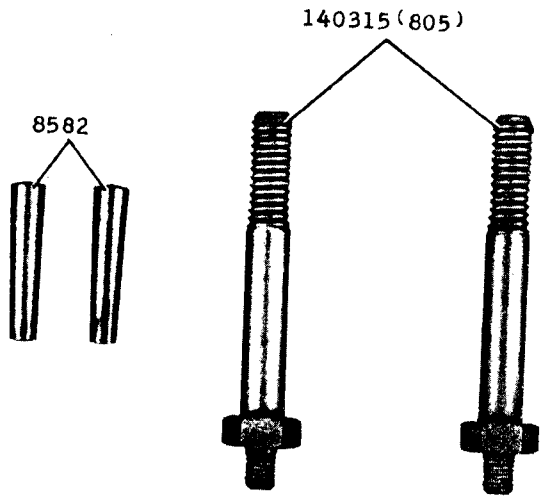
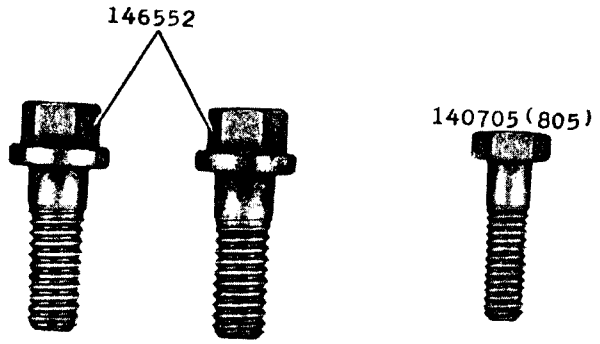

8288-2/3

251-II

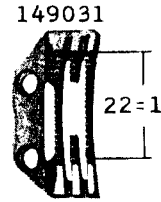

147336 (850)

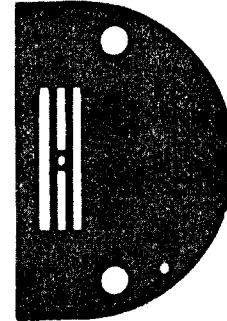

143219

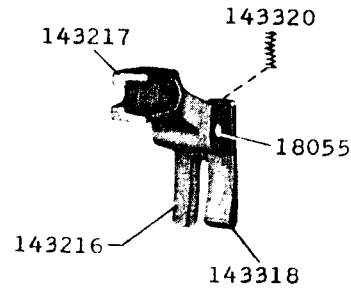

147338

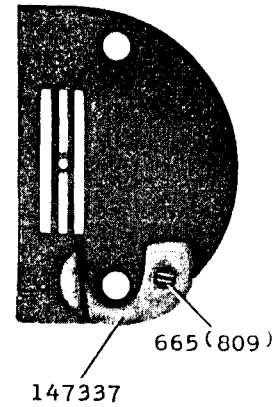

8289-2/3

251-II

147305

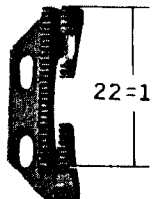

22=1

147309 (850)

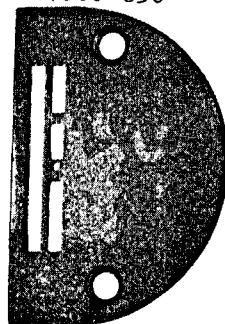

147326

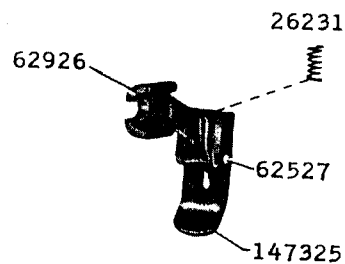

26231

62926

62527

147325

8290-2/3

251-II

147327

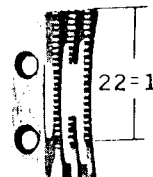

22=1

147328 (850)

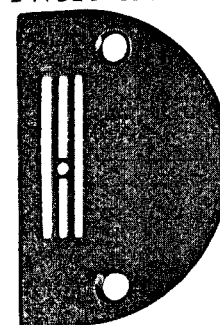

160674

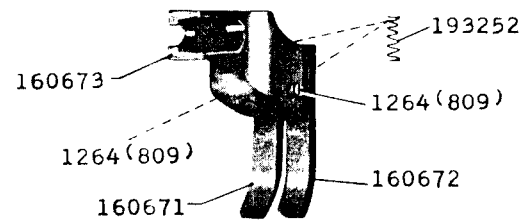

193252

160673

1264 (809)

1264 (809)

160672

160671

147305

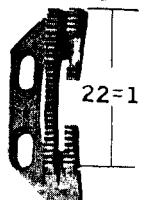

22=1

147309 (850)

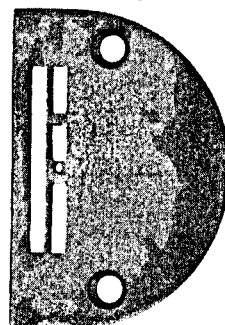

147308

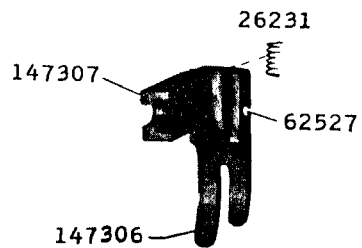

26231

147307

62527

147306

160677

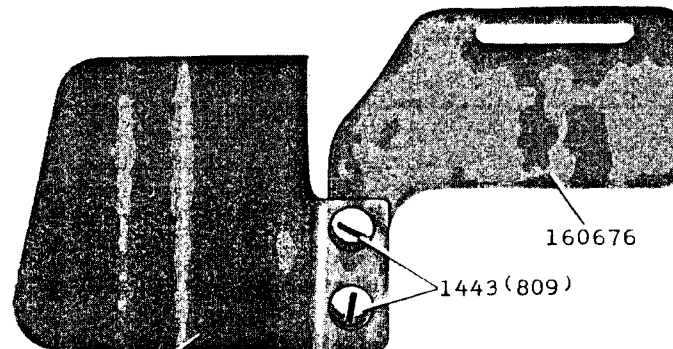

160676

1443 (809)

160675

8291-2/3

251-II

147305

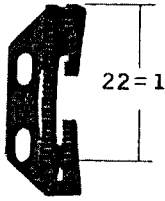

22=1

147309 (850)

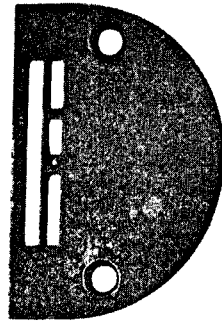

147331

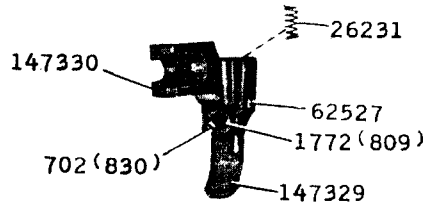

8292-2/3

251-II

147315

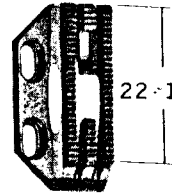

22=1

147320 (850)

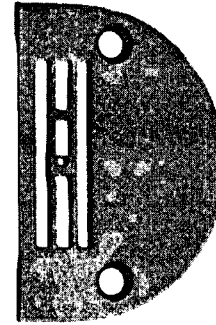

147319

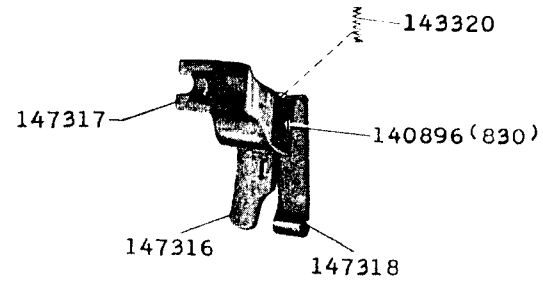

147324 (850)

147321

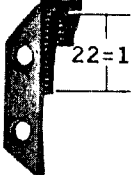

22=1

147323

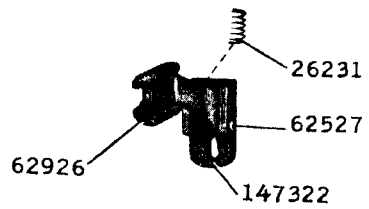

8293-2/3

251-II

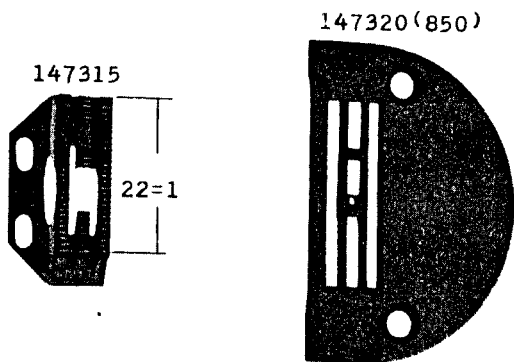

147335

147380

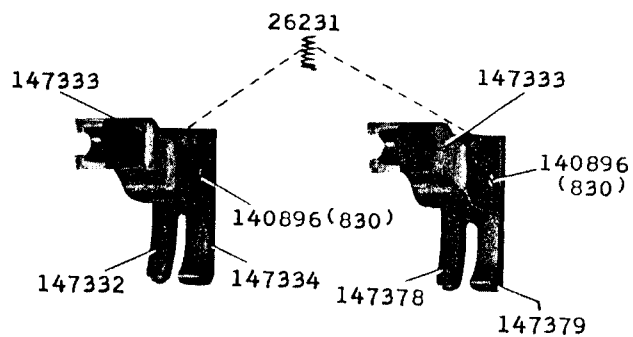

147383

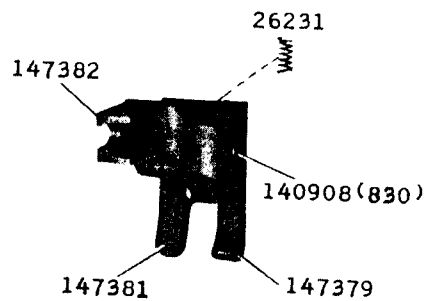

8294-2/3

251-II

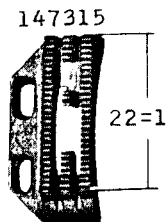

147320(850)

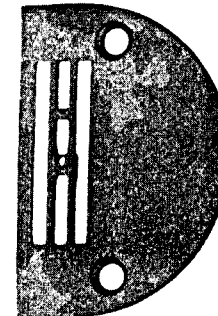

147371

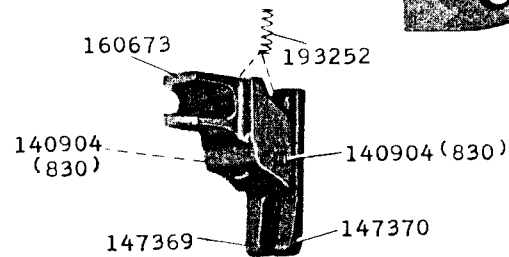

147309(850)

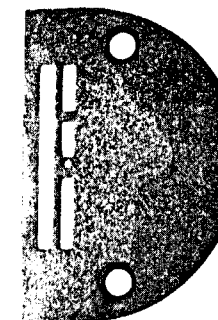
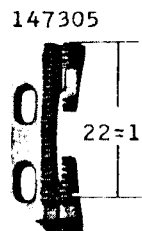

147312

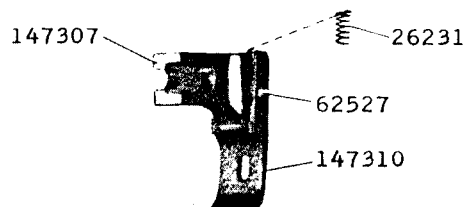

8295-2/3

251-II

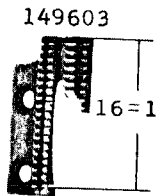

26606

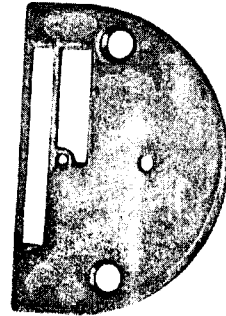

8296-2/3

251-II

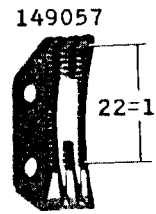

142060 (850)

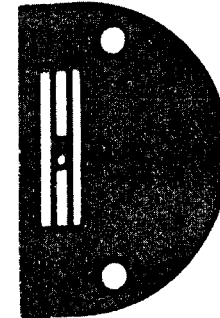

147340

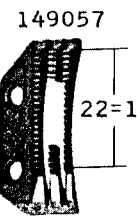
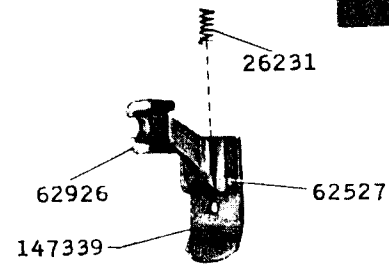

142060 (850)

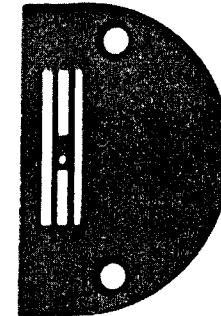

143219

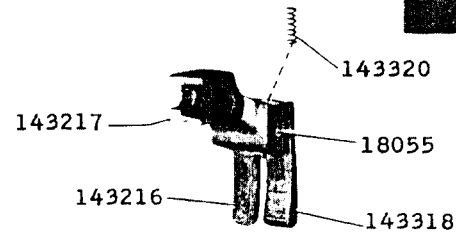

8297-2/3

25I-II

149137

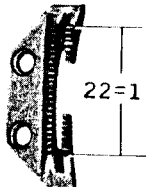

22=1

147314

143278 (850)

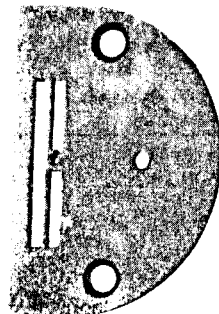

26231

62926



62527

147313

147315

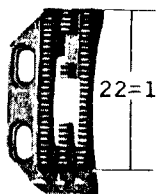

22=1

147349

147320 (850)

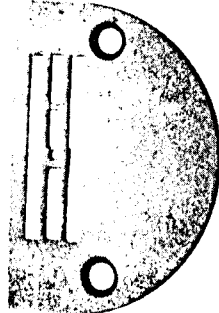

26231

147348



26276

702 (830)

1772 (809)

147347

8298-2/3

25I-I2

147305



22=1

147308

147374 (850)

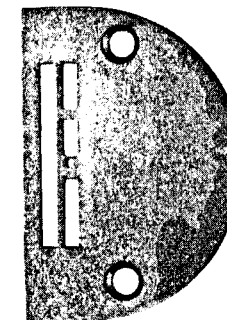

26231

147307



62527

147306

147315

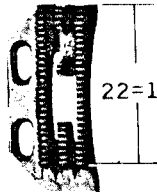

22=1

147308

147388 (850)

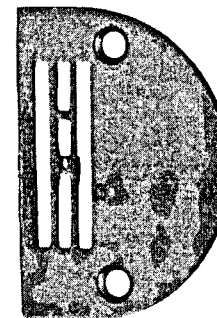

26231

147307



62527

147306

8299-2/3

251-12

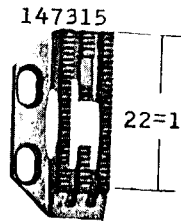

147346 (850)

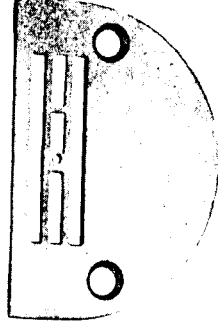

147335

147380

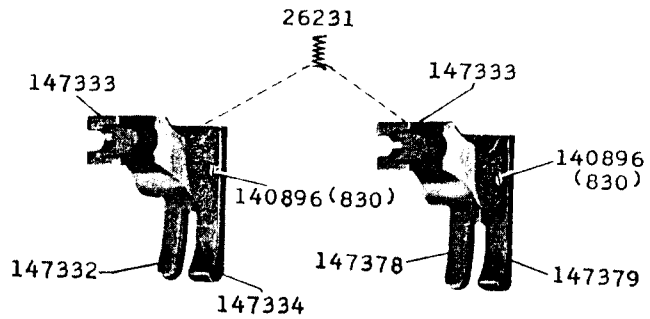

147383

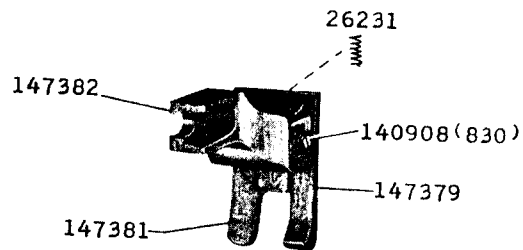

21251-2/3

251-12

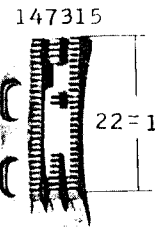

147346 (850)

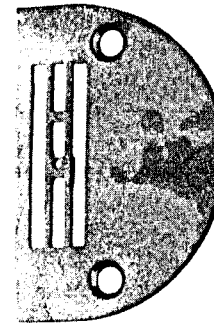

147371

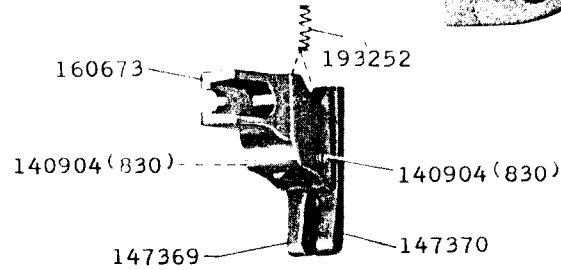

147346 (850)

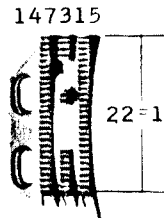

147349

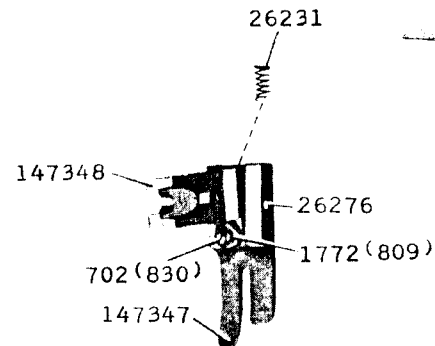

21252-1/2

151434
259074

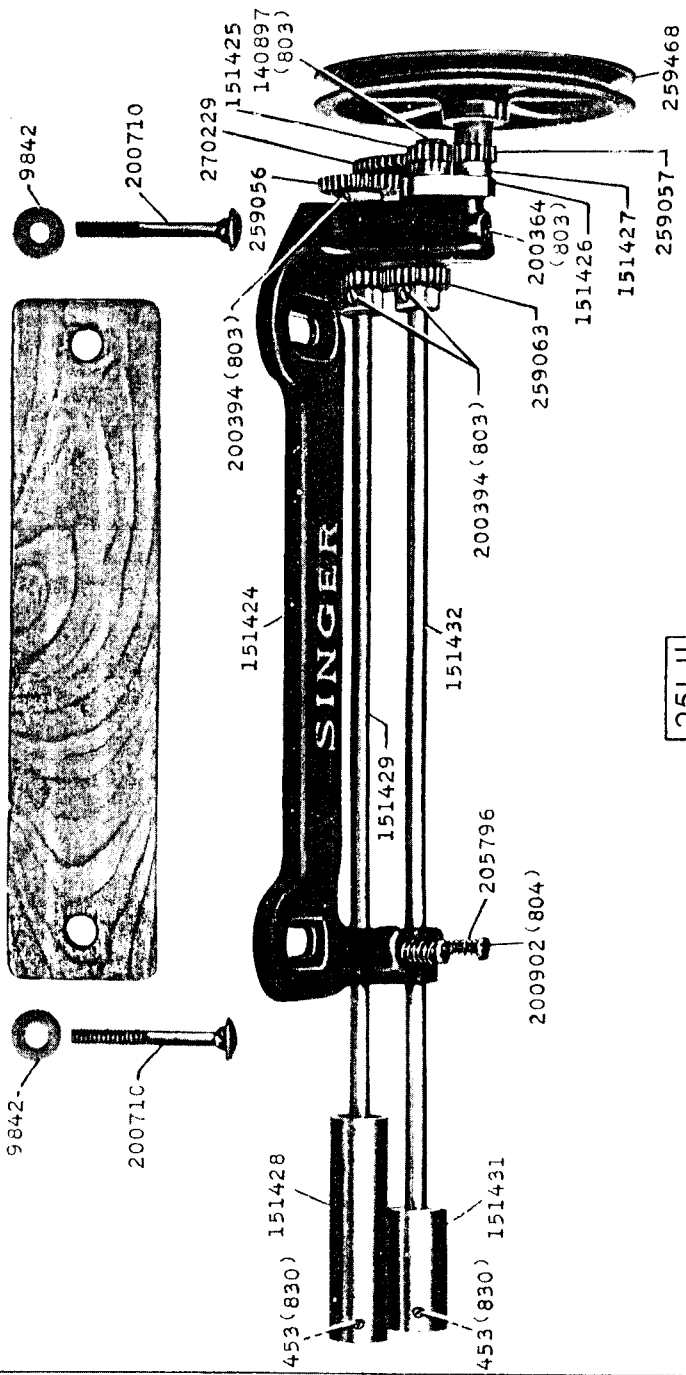

21253-1/2

251-II

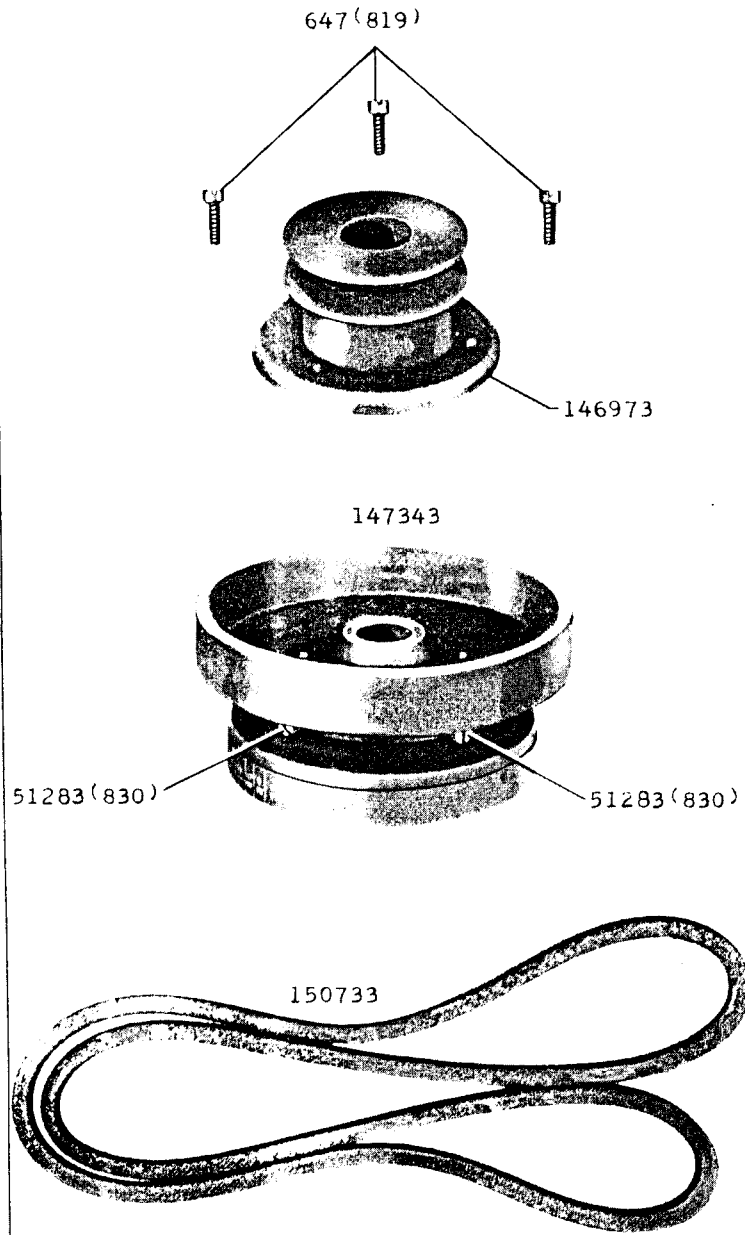

251-III

21254-1/2

147484

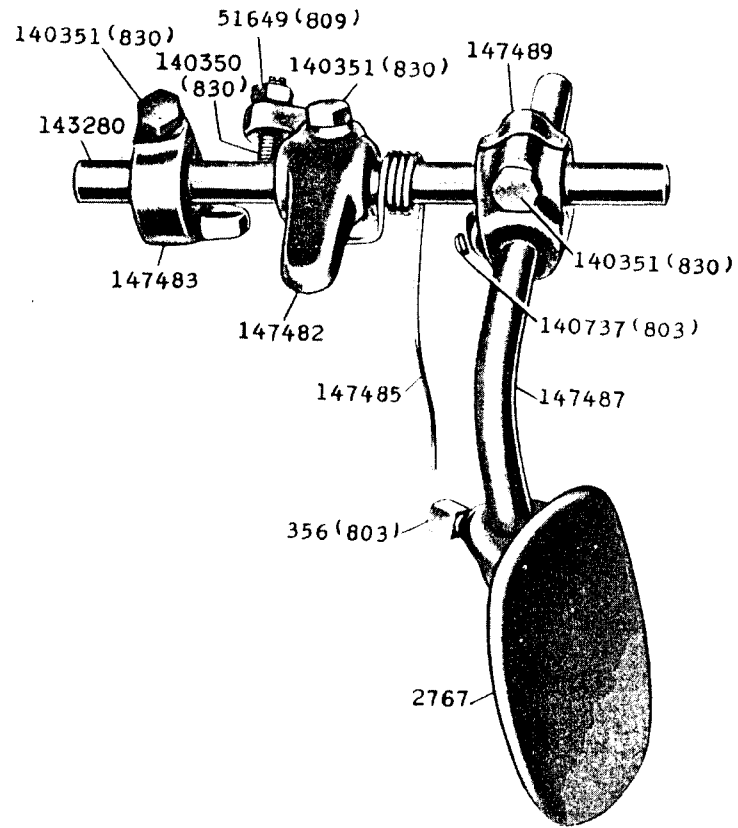

21255-1/3

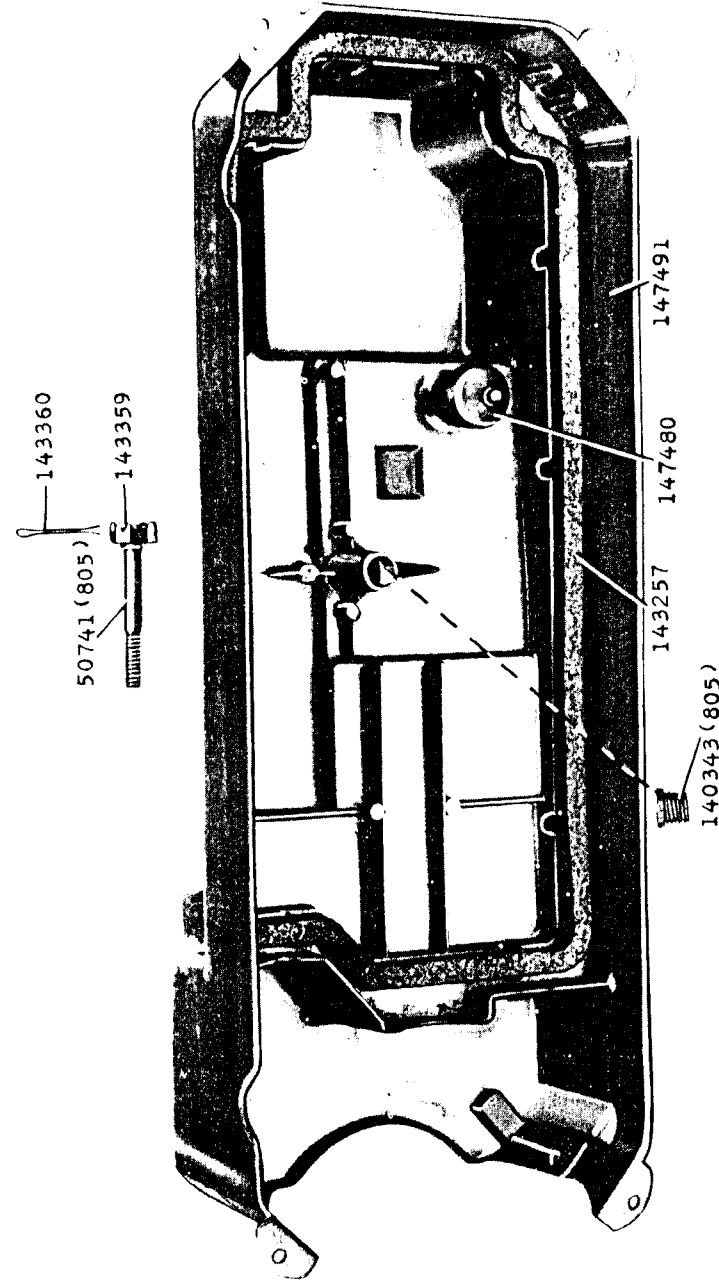

23253 - 3/8

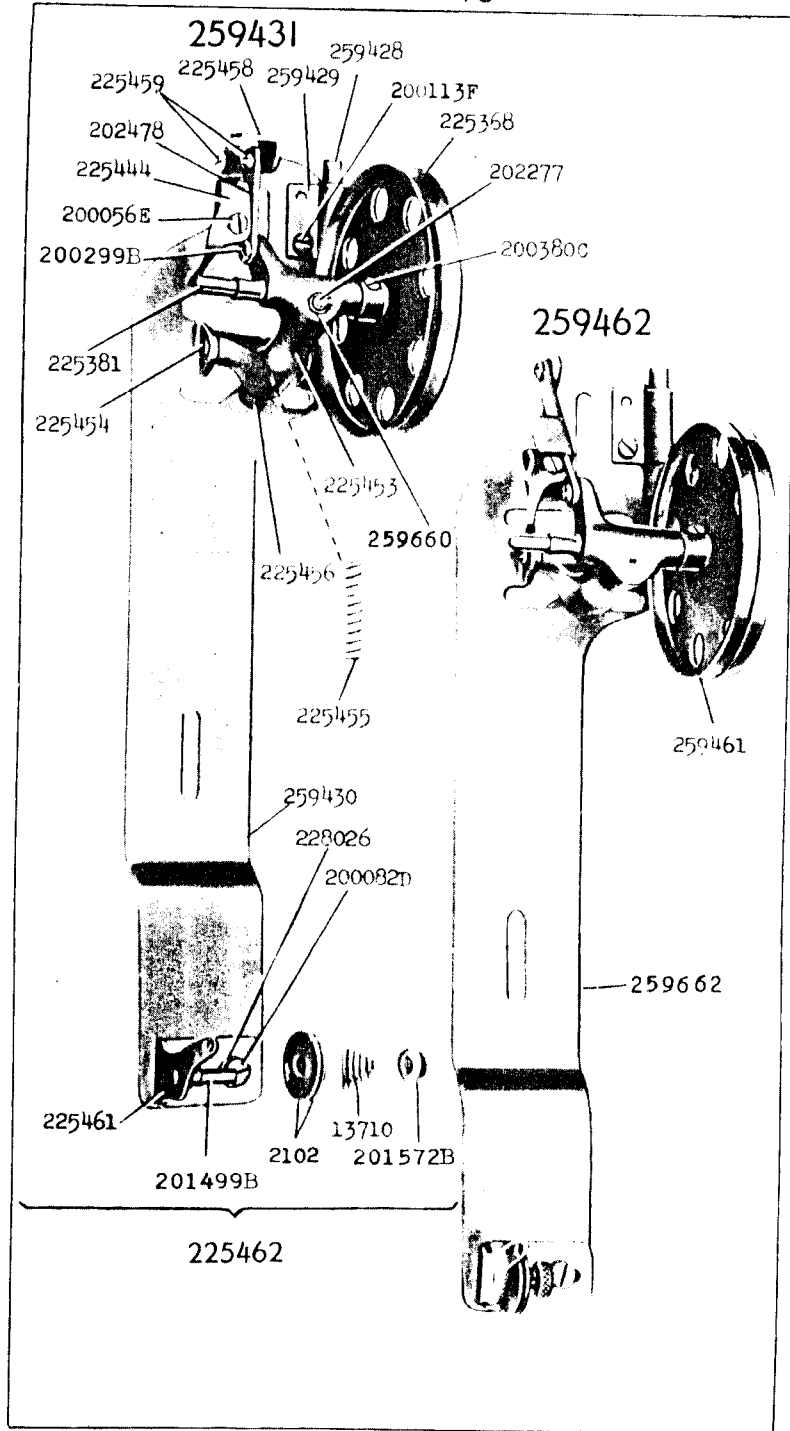

24193 1/6

228776

