

**SINGER**  
**451K25**

# INSTRUCTIONS FOR ORDERING

In ordering from this List, the prefix and affix letters with the part number MUST BE quoted exactly as they are shown in the first column.

A number always indicates the same part in whatever List it may appear, or for whatever machine.

The affix letters (where shown) indicate the style of finish, as follows:—

- A. Hardened, Polished, Nickel Plated and Buffed.
- B. Polished, Nickel Plated and Buffed.
- C. Hardened only.
- D. Polished only.
- E. Soft, Not Polished.
- F. Hardened and Polished.
- G. Bright Rumbled and Nickel Plated.
- H. Blued.
- J. Nickel Plated only.
- K. Hardened and Nickel Plated.
- L. Brass Plated.
- M. Oxidized.
- R. Phosphate Coating Formed on Surface of Iron or Steel.
- S. Cadmium Plated.
- T. Copper Plated.
- U. Zinc Plated.
- V. Silver Plated.
- W. Polished and Nickel Plated.
- X. Black Oxide for Iron and Steel.
- Y. Black Nickel Plated only.
- Z. Chromium Plated.
- A.A. Buffed and Chromium Plated.
- A.B. Hardened, Polished, Buffed and Chromium Plated.
- A.E. Hardened, Bright Rumbled and Nickel Plated.
- A.F. Hardened, Bright Rumbled, Nickel Plated, Bright Rumbled and Chromium Plated.
- A.G. Alumilite (Plain).
- A.H. Alumilite (Dyed). Colour must be stated.
- A.J. Polished, Nickel Plated and Chromium Plated.
- A.K. Hardened, Polished, Nickel Plated and Chromium Plated.
- A.L. Heat Treated for Toughness.
- A.L.D. Heat Treated for Toughness and Polished.
- A.L.X. Heat Treated for Toughness and Black Oxide.
- A.S. Black Moulded Phenolic.
- A.T. Beige Moulded Phenolic.
- A.U. Brown Moulded Phenolic.
- A.W. Hardened then Flame Coated with Tungsten Carbide.
- B.A. Chrome Nickel, Satin Finish.
- B.B. Hardened and Chrome Nickel, Satin Finish.
- C.R. Hardened and Phosphate Coating Formed on Surface of Steel.
- C.U. Hardened and Zinc Plated.
- F.J. Hardened, Polished and Nickel Plated.
- T.A. Hardened, Polished, Copper and Nickel Plated and Buffed.
- T.B. Copper and Nickel Plated and Polished.
- T.J. Copper and Nickel Plated only.
- T.K. Hardened, Copper and Nickel Plated.
- T.L. Copper and Brass Plated.
- T.M. Copper Plated and Oxidized.
- X.C. Hardened and Black Oxide for Iron and Steel.
- Z.A. Hardened, Polished, Nickel Plated, Buffed and Chromium Plated.
- Z.B. Polished, Nickel Plated, Buffed and Chromium Plated.
- Z.C. Hardened and Chromium Plated.
- Z.D. Polished and Chromium Plated.
- Z.G. Bright Rumbled, Nickel Plated, Bright Rumbled and Chromium Plated.
- Z.J. Nickel and Chromium Plated.
- Z.T. Copper and Chromium Plated.

Parts marked with an asterisk (\*) are furnished only when the repairs are made at Factory.

# LIST OF PARTS COMPLETE

FOR

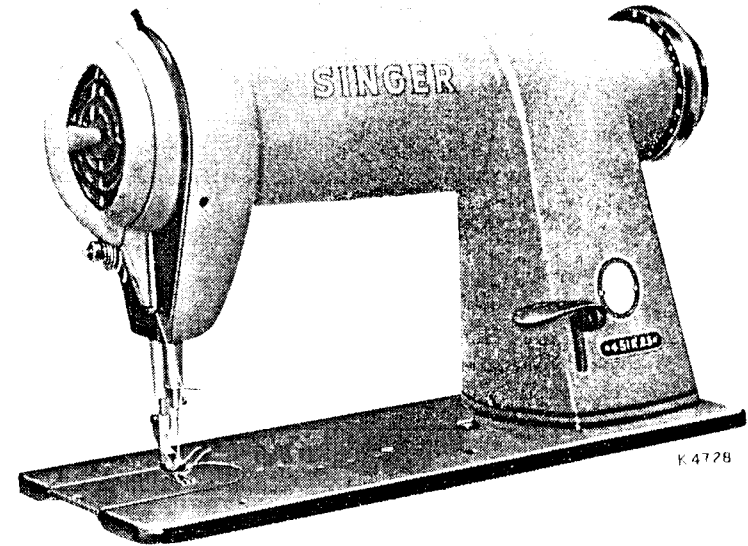

## MACHINE No. 451K25

SINGLE ROTARY THREAD TAKE-UP.

HAND OPERATED REVERSE FEED MECHANISM.

HIGH SPEED. LOCK STITCH. SINGLE NEEDLE. SHORT ARM.  
FOR STITCHING LIGHT AND MEDIUM WEIGHT FABRICS.

No.	Plate	Name	
*276186		Arm	...
276002	2796	" Cover (back)	...
200053X	2796	" " ( " ) Screw (2)	...
201235	2796	" Position Pin (2)	...
200004c	2796	" Screw (2)	...
350390c		" Screw	...
202005	2796	" " Washer (3)	...
*276003	2791	" Shaft	...
276004	2791	" " 276003 with 200333c, 200378c, 272143 and 276021 to 276023	...
272142	2791	" " Ball Bearing (back)	...
272143	2791	" " " " (front)	...
270926	2791	" " Connection Belt (reinforced neoprene)	...

No.	Plate	Name
271127	2791	Arm Shaft Connection Belt Pulley with 200363al, 350492c and two 214206
350492c	2791	" " " " " Position Screw
200363al	2791	" " " " " Set Screw
214206	2791	" " " " " Spring Flange
*276187	---	Bed
270009	2796	" Slide
276226	2792	Face Plate with 276054 and four 200586x
276054	2792	" " Thread Guard
200586x	2792	" " " " Screw
350503alx	2792	" " Screw (8)
272106	2793	Feed Bar
272107	2793	" " Hinge Pin
272112	2793	" " " " Lubricating (felt)
200394c	2793	" " " " Set Screw
272108	2793	" " " " Thrust Washer
272109	2793	" " Lifting Crank with 200040c
200040c	2793	" " " " Pinch Screw
272110	2793	" " " " Link
200169c	---	" " " " Cap Screw (2)
272115	2793	" " " " Oiling Wick
272111	2793	" " " " " " Clamp
(3/5-3) 14903 <del>2626</del> 208AL 50117c	2626	" Dog, 19 teeth (22 teeth to the inch) for 52033
276153	2793	" " Screw (2)
276154	2793	" Driving Connection
276230	2793	" " " " 276153 with 270016
350507c	2793	" " " " Crank with 200040c
201531e	2793	" " " " Hinge Screw
200040c	2793	" " " " " " Nut
276169	2793	" " " " Pinch Screw
276170	2793	" " " " Link
276171	2793	" " " " " 276169 with 270653
244071	2793	" " " " " Hinge Pin with 244071
200394c	2793	" " " " " " Oil Packing (wick)
270653	2793	" " " " " " Set Screw
270016	2793	" " " " " Needle Bearing
270017	2795	" " " " " Needle Bearing
276188	2795	" " " " Eccentric
270137	2795	" " " " " Adjusting Disc
276009	2795	" " " " " Spring
201220c	2795	" " " " " Collar with 201220c
240231	2795	" " " " " " " " Set Screw
		" " " " " Friction Gib

(2) (3-38)

No.	Plate	Name
350578xc	2795	Feed Driving Eccentric Friction Gib Adjusting Screw
350562xc	2795	" " " " " " " " Set Screw
276180	2795	" " Flange with 200333c, 200346c, two each 350562xc and 350578xc
200333c	2795	" " " " Position Screw
200346c	2795	" " " " Set Screw
272116	2793	" " Rock Shaft with two each 200394c and 270942
270941	2793	" " " " Centre (2)
201254c	2793	" " " " " " Set Screw (2)
270942	2793	" " " " Insert (nylon)
270013	2793	" Lifting Connection
270014	2793	" " " " 270013 with 270016
200545c	2793	" " " " Hinge Screw
201522c	2793	" " " " " " Nut
270016	2793	" " " " Needle Bearing
276231	2795	" " Eccentric with 200382c and 201220c
201220c	2795	" " " " Position Screw
200382c	2795	" " " " Set Screw
272118	2793	" " Rock Shaft with two 270942
270941	2793	" " " " Centre (2)
201254c	2793	" " " " " " Set Screw (2)
270942	2793	" " " " Insert (nylon)
270140	2795	" Regulating Stud
240245	2795	" " " " Retaining Spring
270026	2795	" " " " Spring
276157	2793	" Reversing Lever with 350477c
276158	2793	" " " " Connection
201107c	2793	" " " " Hinge Screw (lower)
350509c	2793	" " " " " " (upper)
201520x	2793	" " " " " " ( " ) Nut
276160	2793	" " " " Handle
200575x	2793	" " " " " " Screw
201529x	2793	" " " " " " Nut
276159	2793	" " " " Hinge Pin
350477c	2793	" " " " " " Set Screw
350569c	2793	" " " " Stop Pin
201524x	2793	" " " " " " Nut
276181	2793	" Mechanism Support Link
276182	2793	" " " " Stud
200346c	2795	" " " " " " Set Screw
276189	2793	" Shaft with 276191
276162	2793	" " " " Bushing (back)
276179	2793	" " " " " (front)
200382c	2793	" " " " " " Set Screw (2)
276163	2793	" " " " Crank with 200040c and 200386c
276164	2793	" " " " Hinge Stud with 276016
276046	2793	" " " " " " Oil Packing (wick)



No.	Plate	Name
<del>270871</del> <sup>272131</sup>	<del>2772</del>	Rotating Hook <sup>272131</sup> with 270872, <del>270871</del> and three 1367e ...
270010	2772	" " <sup>270050</sup> with 52237 ...
52235	2772	" " <sup>372158</sup> Bobbin ...
52236	2772	" " " " Case ...
40393	2772	" " " " 52235 with 591f, 1380e and 10394
270872	2772	" " " " Hinge, Nos. 2974, 10392 and 125320
272131	2772	" " " " " " Holder (chromium plated) ...
200077d	2772	" " " " " " " " Position Bracket ...
40392	2772	" " " " " " " " " " Screw ...
125320	2772	" " " " " " " " Latch ...
2974	2772	" " " " " " " " Lever ...
2975	2772	" " " " " " " " Fulcrum Pin ...
592e	2772	" " " " " " " " Spring ...
40394	2772	" " " " " " " " Stop Screw ...
591f	2772	" " " " " " " " Tension Spring ...
1380e	2772	" " " " " " " " " " Regulating Screw ...
52237	2772	" " " " " " " " " " Screw ...
270873	2772	" " " " " " " " complete, Nos. 592e, 2975, 40393 and 52236
276044	2795	" " " " " " " " 52237 with 270872 <sup>(for Argenta) 1/60</sup> ...
272144	2795	" " " " " " " " Driving Shaft ...
276045	2795	" " " " " " " " Ball Bearing ...
276046	2795	" " " " " " " " Bushing with 276046 ...
200346c	2795	" " " " " " " " Oil Packing (wick) ...
270169	2795	" " " " " " " " Set Screw ...
		Connection Belt Pulley with 214206 and two 200070c ...
200070c	2795	Rotating Hook Driving Shaft Connection Belt Pulley Set Screw
214206	2795	" " " " " " " " Spring
		Flange
276047	2795	" " " " " " " " Gear (internal teeth) with 200382x <sup>ALx 1/2</sup> and 201220x <sup>ALx 1/2</sup> ...
201220x	2795	" " " " " " " " Position Screw ...
200382x	2795	" " " " " " " " Set Screw ...
270036	2795	" " " " " " " " Oil Lead Wire ...
270879	2772	" " " " " " " " Oil Guard ...
276177	2796	" " " " " " " " Reservoir Cover ...
<del>276177</del> <sup>276491</sup>	<del>2796</del> <sup>2796</sup>	" " " " " " " " " " Gasket ...
200041x	2796	" " " " " " " " " " Screw (6) ...
270878	2772	" " " " " " " " Retaining Washer (felt) ...
143301	2772	" " " " " " " " Wick (felt) ...
<del>270876</del> <sup>270876</sup>	<del>2772</del> <sup>2772</sup>	" " " " " " " " Section ...
1367e	2772	" " " " " " " " " " Screw ...
1253al	2772	" " " " " " " " Set Screw ...
276059	2795	" " " " " " " " Shaft ...
270163	2795	" " " " " " " " Bushing ...

No.	Plate	Name
270880	2795	Rotating Hook Shaft Bushing Oil Packing (wick) ...
200346c	2795	" " " " " " " " Set Screw ...
270164	2795	" " " " " " " " End Bearing ...
201215d	2795	" " " " " " " " " " Screw ...
202423	2795	" " " " " " " " Oil Filter Wick ...
276061	2795	" " " " " " " " " " Holder ...
276062	2795	Rotating Hook Shaft Oil Filter, complete, Nos. 202423 and 276061
350498c	2795	Rotating Hook Shaft Oil Regulating Screw ...
270044	2795	" " " " " " " " Thrust Washer ...
276060	2795	Rotating Hook Shaft Bushing, complete, Nos. 270044, 270163, 270164, 270880, 276059, 276062, 350498c and two 201215d ...
270874xc	2772	Rotating Hook Thread Guard ...
1053e	2772	" " " " " " " " " " Screw ...
2102	2792	Tension Disc ...
276048	2794	" " Releaser (adjustable) ...
200132e	2794	" " " " Screw ...
32572	2792	" " Releasing Disc ...
270086	2792	" " " " Pin ...
13710	2792	" " Spring ...
50304c	2792	" " Stud ...
52098	2792	" " 50304c with 1560c ...
50305c	2792	" " Set Screw ...
276055	2792	" " Thread Guide Pin ...
1560c	2792	" " Thumb Nut ...
276049	2792	Tension, complete, Nos. 13710, 32572, 39652, <del>52088</del> <sup>142090</sup> 52098, 270086 and two 2102 ...
276050	2792	Thread Cutter ...
200583x	2792	" " " " Screw ...
276051	2792	" " Guide ...
263118	2794	" " " " (on Needle Bar Bushing) ...
350503alx	2792	" " " " Screw ...
276057	2794	" " Pull-off ...
<sup>460</sup> 200145al	2794	" " " " Screw (2) ...
276052	2792	" " Retainer (front) ...
200397x	2792	" " " " ( " ) Set Screw ...
270080	2792	" " " " (rear) ...
200366x	2792	" " " " ( " ) Set Screw ...
39652	2792	" " Take-up Spring ...
<sup>142090</sup> <del>52088</del> <sup>1/60</sup>	2792	" " " " Regulator with 50305c ...
153xc	2792	" " " " " " Set Screw ...
52033	2626	Throat Plate (small needle hole) for 52031 ...
<sup>1/60</sup> 691+x	2626	" " " " Screw (2) ...

## ACCESSORIES

No.	Plate	Name
25878	2627	Cloth Guide
50190	2627	" " Thumb Screw
228478	18311	Drip Pan with four $\frac{3}{8}$ " wire nails
12361	2627	Machine Hinge Connection (2)
41400	2627	" Rest Pin (wood)
88 x 1	—	Needles, six, size 16
120342	2627	Oiler (copper plated) with 120343
120343	2627	" Spout ( $3\frac{1}{2}$ " long)
270010	18370	Rotating Hook Bobbin (2)
270155	2795	" " Oil Reservoir Oil Gauge
120378	2627	Screw Driver (Bobbin Case)
85318	2627	Screw Driver
(x/60) 88698	—	Tin of Oil ( $\frac{1}{2}$ pint)
240566	—	Wrench

## PRESSER FOOT

(for General Work)

(only supplied when specified on order and at an extra charge) (x/60)

No.	Plate	Name
86659	—	Presser Foot Plate
86660	—	" " Shank
86661	—	Presser Foot (hinged), complete, Nos. 86659 and 86660

## BOBBIN WINDER

(Swinging Automatic, Right Hand)

For "V" Belt Drive

No.	Plate	Name
259428	2624	Brake (leather)
259429	2624	" Clamp
200113f	2624	" " Screw
225453	2624	Frame with <del>200277</del> and 259660
225454	2624	" Hinge Pin <del>200277</del> (x/60)
(x/60) 240277	2624	" Oil Packing (wick)
259660	2624	" " Well Washer
225455	2624	" Spring
225456	2624	" " Plunger
104211	2624	Pulley with 200380c
200380c	2624	" Set Screw
225381	2624	Spindle

## ACCESSORIES

No.	Plate	Name
225444	2624	Stop Latch
200056e	2624	" " Screw
225458	2624	" " Thumb Lever
225459	2624	" " " " Hinge Stud
225459	2624	" " " " Joint Stud
202478	2624	" " Trip Lever
200299h	2624	" " " " Hinge Screw
225461	2624	Tension Bracket with 201499h
200082d	2624	" " Screw
228026	2624	" " Washer
2102	2624	" Disc
13710	2624	" Spring
201499h	2624	Tension Stud
201572h	2624	" " Thumb Nut
225462	2624	Bobbin Winder Tension Bracket, complete, Nos. 13710, 201572h, 225461 and two 2102
259430	2624	Bobbin Winder and Tension Bracket Base
104212	2624	Bobbin Winder (swinging automatic, right hand), complete, Nos. 104211, 200056e, 200082d, 200113f, 200299h, 202478, 225381, 225444, 225453 to 225456, 225458, 225462, 228026, 259428 to 259430, two each 225459 and wood screws $\frac{3}{8}$ " No. 12 R.H.B.

## BELT GUARD

(only supplied when specified on order, and at an extra charge).

No.	Plate	Name
106502	2778	Belt Guard with <del>two</del> <sup>1/61</sup> SS706x
106503	2778	" " Bracket with three SS706x
SS707	2778	" " " Hinge Screw
SS706x	2778	" " " Screw
SS706x	2778	" " " Screw
Tool 293	2778	" " " Key
106504	2778	" " Support <sup>(3-58)</sup>
106505	2778	Belt Guard, complete, Nos. <del>Tool 293</del> SS707 and 106502 to 106504

## KNEE LIFTER

No.	Plate	Name
228713	18311	Rock Lever with two 350231c
228707	18311	" " Bracket with 200347c and three wood screws $\frac{3}{8}$ " No. 12
228709	18311	" " " 228707 with 228363, 228367, 228386, 228455 and 228713
228370	18311	" " Extension with 200530c
350231c	18311	" " " Set Screw
228363	18311	" " Hinge Pin

No.	Plate	Name
228364	18311	Rock Lever Knee Plate with 350231c
228388	18311	" " " " Arm
350231c	18311	" " " " " Set Screw
350231c	18311	" " " " " Set Screw
228455	18311	" " Position Spring
228365	18311	" " Rod
200530c	18311	" " " " Set Screw
228386	18311	" " Spring
228367	18311	" " Stop Stud
200347c	18311	" " " " " Set Screw
228710	18311	Knee Lifter Rock Lever, complete Nos. 228364, 228365, 228370, 228388 and 228709

(Other Knee Lifter parts are listed with parts of Machine Head)

## THREAD UNWINDER

No.	Plate	Name
228692	18362	Spool Pin
<sup>3/8</sup> 201528h	18362	" " Nut
<del>228693</del> <sup>82538</sup>	<del>18362</del>	" " Washer
225257	18362	" Rest (for two spools) with 201018c, two each 201528h, 228692 and <del>228693</del> <sup>82538 (3-58)</sup>
150203	18362	Spool Rest Cushion (felt)
225388	18362	" " Rod
200383c	18362	" " " Set Screw
201018c	18362	" " " Set Screw
<sup>3/4</sup> 27739	18362	Thread Cone (wood) (only supplied when specified on order and at an extra charge) <sup>(2/60)</sup>
201696h	18362	" " Lock Nut
225326	18362	" " Position Cup
225324	18362	" " Rod with 208al and 225322
208al	18362	" " " Screw
225322	18362	" " " Washer
225258	18362	Thread Unwinder (for two spools), complete Nos. 201696h, 225257, 225324, 225326, 225388, <del>201018c</del> <sup>202492 (3-58)</sup> , two each 150203, 225391 and three wood screws <sup>259658 (1/60)</sup> No. 12

*Note 2/60*

## MISCELLANEOUS PARTS

Used in conjunction with Thread Unwinder

No.	Plate	Name
259370	18362	Spool Pin
259378	18362	" " Arm with 217e and 259379
232896	18362	" " " Bracket with two 418al
418al	18362	" " " " Set Screw
418al	18362	" " " " Set Screw
259371	18362	" " Cap (bakelite)
1010f	18362	" " Hinge Screw
259379	18362	" " Retaining Spring
217e	18362	" " " " Screw
259372	18362	" " Washer
259373	18362	Spool Pin, complete, Nos. 1010f and 259370 to 259372
60913	18362	Spool Weight with 60914
60914	18362	" " Centre Pin
225377	18362	" Wire, for small spools
27739	18362	Thread Cone (wood)
225390	18362	" " Holder

## Numerical List of Parts

No.	Plate	Name
176x	2794	Presser Foot Screw, for 272121 ...
208al	18362	Thread Unwinder Thread Guide Rod Screw,
(3-58) 208al	2626	Feed Dog Screw ...
		Screw, for 250278 <del>...</del> (4/60) ...
Tool 293	2778	Belt Guard Screw Key for 106503 SS 706 (3-58)
<del>448al</del>	<del>18362</del>	<del>Thread Unwinder Spool Pin Arm Bracket</del>
		<del>Set Screw, for 232896 (7/60) ...</del>
448al	18362	Thread Unwinder Spool Pin Arm Set Screw, for 232896 (7/60) ...
453xc	2792	Thread Take-up Spring Regulator Set Screw
591f	2772	Rotating Hook Bobbin Case Tension Spring Regulating Screw, for 52236 ...
592e	2772	Rotating Hook Bobbin Case Latch Stop Screw for 52237 ...
7/60 6914xc	2626	Throat Plate Screw ...
SS706x	2778	Belt Guard Bracket Screw for 106503 ...
SS706x	2778	Belt Guard Screw for 106502 ...
SS707	2778	Belt Guard Bracket Hinge Screw for 106505
<del>1010f</del>	<del>18362</del>	<del>Thread Unwinder Spool Pin Cap Hinge</del>
		<del>Screw, for 250278 (7/60) ...</del>
1053e	2772	Rotating Hook Thread Guard Screw, for <del>270809</del> 272137 (7/60) ...
1253al	2772	Rotating Hook Set Screw, for 270808 272136 (7/60)
1367e	2772	Rotating Hook Section Screw, for 270870 272138 (7/60)
1380e	2772	Rotating Hook Bobbin Case Tension Spring Screw, for 52236 ...
1560e	2792	Tension Thumb Nut, for 52098 ...
2102	2624	Bobbin Winder Tension Disc, for 225162 ...
2102	2792	Tension Disc, for 276049 ...
2974	2772	Rotating Hook Bobbin Case Latch Lever Fulcrum Pin, for 40393 ...
2975	2772	Rotating Hook Bobbin Case Latch Spring, for 52237 ...
12361	2627	Machine Hinge Connection ...
13710	2624	Bobbin Winder Tension Spring, for 225162 ...
13710	2792	Tension Spring, for 276049 ...
24541	2626	Presser Foot Plate for 24983
24982	2626	Presser Foot Shank for 24983
24983	2626	Presser Foot (spring, hinged), complete, Nos. 24541, 24982, 26231 and 62527 <del>...</del> No. Cancelled 7/60 and 161066 7/60
25878	2627	Cloth Guide ...
26231	2626	Presser Foot Spring, for 24983 and 161066 7/60
27739	18362	Thread Unwinder Thread Cone (wood) ...



No.	Plate	Name
32572	2792	Tension Releasing Disc, for 276049 ...
39652	2792	Thread Take-up Spring, for 276049 ...
40392	2772	Rotating Hook Bobbin Case Latch, for 40393
40393	2772	Rotating Hook Bobbin Case Hinge, Nos. 2974, 40392 and 125320, for 52237 ...
40394	2772	Rotating Hook Bobbin Case Tension Spring, for 52236 ...
(3/58) 41400	2627	Machine Rest Pin (wood) ...
<i>Obsolete use 2088</i> 50117c	2626	Feed Dog Screw ...
50190	2627	Cloth Guide Thumb Screw ...
50304c	2792	Tension Stud, for 52098
50305c	2792	Tension Stud Set Screw, for 52098 <i>142090 1/61</i>
52031	2626	Feed Dog, 19 teeth (22 teeth to the inch) for 52033 ...
52033	2626	Throat Plate (small needle hole) for 52031
<del>52083</del>	<del>2792</del>	<del>Thread Take-up Spring Regulator with 50305c, for 276049 ...</del>
52098	2792	Tension Stud 50304c with 1560c, for 276049
52235	2772	Rotating Hook Bobbin Case, for 52236 ...
52236	2772	Rotating Hook Bobbin Case 52235 with 591f, 1380e and 40394, for 52237 ...
52237	2772	Rotating Hook Bobbin Case, complete, Nos. 592e, 2975, 40393 and 52236, for 270871 and 270873 ...
<del>60913</del>	<del>18362</del>	<del>Thread Unwinder Spool Weight with 60914 (1/60)</del>
<del>60914</del>	<del>18362</del>	<del>Thread Unwinder Spool Weight Centre Pin, for 60913 (1/60)</del>
62527	2626	Presser Foot Hinge Pin, for 24983 ...
67425	2792	Rotary Take-up Guard Cover Hinge Screw Spring Washer ...
85318	2627	Screw Driver
82538	---	Thread Unwinder Spool Pin Washer for 225257 ... <i>3/60</i>
86660	---	Presser Foot Shank for 86661 ...
86661	---	Presser Foot (hinged), complete, Nos. 86659
86698	---	Tin of Oil (1/2 pint) ... <i>(1/60)</i>
104211	2624	Bobbin Winder Pulley with 200380c for 104212 ...
104212	2624	Bobbin Winder (swinging automatic, right hand), complete, Nos. 104211, 200056c, 200082d, 200113f, 200299h, 202478, 225381, 225444, 225453 to 225456, 225458, 225462, 228026, 259428 to 259430, two each 225459 and wood screws 3/4" No. 12 R.H.B. ...
106502	2778	Belt Guard with two SS706x, for 106505 ...
106503	2778	Belt Guard Bracket with three SS706x, for 106505 ...

*(3/58)*  
*Obsolete use 2088*  
*No. Cancelled, order 149031.*  
*1/61*

*1/61*  
*1/61*

*7/60*

No.	Plate	Name
106504	2778	Belt Guard Support for 106505 ...
106505	2778	Belt Guard, complete, Nos. <del>Tool 208</del> <sup>3-58</sup> SS707 and 106502 to 106504 ...
120342	2627	Oiler (copper plated) with 120343 ...
120343	2627	Oiler Spout (3 1/2" long) for 120342 ...
120378	2627	Screw Driver (bobbin case) ...
142090	---	Thread Take-up Spring Regulator with 50305c for 276049 ...
149031	---	Feed Dog, 19 teeth (22 teeth to the inch) for 52031 ... <i>(1/60)</i>
161065	---	Presser Foot Plate for 161066 ...
161066	---	Presser Foot (spring hinged) complete, Nos. 62527, 62926, 161065 and 161160 ...
200040e	2793	Feed Driving Collar with 276230 ...
200040c	2793	Feed Bar Lifting Crank Pinch Screw, for 272109 ...
200040e	2793	Feed Reversing Shaft Crank Pinch Screw, for 276163 ...
200041x	2796	Rotating Hook Oil Reservoir Cover Screw
200053x	2796	Arm Cover (back) Screw ...
200054e	2794	Needle Bar Connecting Link Guide Block Screw ...
200056e	2624	Bobbin Winder Stop Latch Screw, for 104212
200069x	2792	Rotary Take-up Guard Screw (short) ...
200070c	2795	Rotating Hook Driving Shaft Connection Belt Pulley Set Screw, for 270169 ...
200077d	2772	Rotating Hook Bobbin Case Holder Position Bracket Screw ...
200082d	2624	Bobbin Winder Tension Bracket Screw, for 104212 ...
200113f	2624	Bobbin Winder Brake Clamp Screw, for 104212 ...
200113f	2796	Knee Lifter Lifting Rod Spring Collar Set Screw, for 227227 ...
200132e	2794	Tension Releaser Screw ...
200145e	2794	Thread Pull-off Screw ...
200161x	2792	Rotary Take-up Guard Cover Grill Screw ...
200169e	---	Feed Bar Lifting Link Cap Screw ...
200263xc	2792	Rotary Take-up Guard Cover Hinge Screw
200272e	2796	Knee Lifter Rock Frame Hinge Screw (front)
200293al	2794	Knee Lifter Lifting Link Hinge Screw ...
200299h	2624	Bobbin Winder Stop Latch Trip Lever Hinge Screw, for 104212 ...
200333c	2795	Feed Driving Flange Position Screw, for 276180 ...
200333c	2791	Needle Bar Crank Position Screw, for 276001

No.	Plate	Name
200344c	2795	Feed Driving Flange Set Screw, for 276180
200344c	2795	Feed Reversing Mechanism Support Stud Set Screw ... ..
200344c	2795	Rotating Hook Driving Shaft Bushing Set Screw ... ..
200346c	2795	Rotating Hook Shaft Bushing Set Screw
200347c	18311	Knee Lifter Rock Lever Stop Stud Set Screw, for 228707 ... ..
200363al	2791	Arm Shaft Connection Belt Pulley Set Screw, for 271127 ... ..
200366x	2792	Thread Retainer (rear) Set Screw ...
200374c	2791	Needle Bar Connecting Link Hinge Stud Set Screw, for 276023 ... ..
200378c	2791	Needle Bar Crank Position Screw Check Screw, for 276004 ... ..
200380c	2624	Bobbin Winder Pulley Set Screw, for 101211
200382c	2795	Feed Lifting Eccentric Set Screw, for 276235
200382c	2793	Feed Reversing Shaft Bushing Set Screw ...
200382x	2795	Rotating Hook Driving Shaft Gear Set Screw, for 276047 ... ..
		<i>ALX 1/61</i>
200383c	18362	Thread Unwinder Spool Rest Rod Set Screw, for <del>250038</del> <i>252470 (3/58)</i> <i>259658 (4/60)</i>
200386c	2793	Feed Reversing Shaft Crank Hinge Stud Set Screw, for 276163 ... ..
200394c	2793	Feed Bar Hinge Pin Set Screw, for 272116
200394c	2793	Feed Driving Connection Link Hinge Pin Set Screw, for 276165 ... ..
200397x	2792	Thread Retainer (front) Set Screw ...
200530c	18311	Knee Lifter Rock Lever Rod Set Screw, for 228370 ... ..
200545c	2793	Feed Lifting Connection Hinge Screw ...
200567xc	2792	Rotary Take-up Clamping Plate Screw ...
200575x	2793	Feed Reversing Lever Handle Screw ...
200577al	2792	Rotary Take-up Screw ... ..
200582x	---	Rotary Take-up Counterbalance Screw for 276033 ... ..
200583x	2792	Thread Cutter Screw ... ..
200586h	2792	Face Plate Thread Guard Screw, for 276226
200679f	2796	Knee Lifter Rock Frame Hinge Screw (back)
200685c	2792	Rotary Take-up Guard Thread Guide Screw
201018c	18362	Thread Unwinder Spool Rest Set Screw, for 225257 ... ..
201107c	2793	Feed Reversing Lever Connection Hinge Screw (lower) ... ..
201215d	2795	Rotating Hook Shaft End Bearing Screw, for 276060 ... ..

No.	Plate	Name
201220c	2795	Feed Driving Eccentric Adjusting Disc Spring Collar Set Screw, for 276009 ...
201220c	2795	Feed Lifting Eccentric Position Screw, for 276231 ... ..
201220x	2795	Rotating Hook Driving Shaft Gear Position Screw, for 276047 ... ..
		<i>ALX 1/61</i>
201254c	2793	Feed Driving Rock Shaft Centre Set Screw
201254c	2793	Feed Lifting Rock Shaft Centre Set Screw ...
201499h	2624	Bobbin Winder Tension Stud, for 225461 ...
201520x	2793	Feed Reversing Lever Connection Hinge Screw (upper) Nut ... ..
201522c	2793	Feed Lifting Connection Hinge Screw Nut...
201524x	2793	Feed Reversing Lever Stop Pin Nut ...
201528h	18362	Thread Unwinder Spool Pin Nut, for 225257
201529x	2793	Feed Reversing Lever Handle Screw Nut ...
201531c	2793	Feed Driving Connection Crank Hinge Screw Nut ... ..
201537c	2792	Rotary Take-up Guard Cover Spring Catch Screw Nut ... ..
201572h	2624	Bobbin Winder Tension Stud Thumb Nut, for 225462 ... ..
201696h	18362	Thread Unwinder Thread Guide Lock Nut, for 225258 ... ..
202005	2796	Arm Screw Washer ... ..
202277	2624	Bobbin Winder Frame Oil Packing (wick) for 225453 ... ..
202277	2794	Needle Bar Connecting Stud Oil Packing Wick for 270057 ... ..
202302	2796	Knee Lifter Lifting Rod Cotter Pin, for 276015 ... ..
202423	2795	Rotating Hook Shaft Oil Filter Wick, for 276062 ... ..
202478	2624	Bobbin Winder Stop Catch Trip Lever ...
202490	---	Thread Unwinder Spool Stand with 200383c, for 225258 ... ..
		<i>3 J8 handle use 259658 (4/60)</i>
214206	2791	Arm Shaft Connection Belt Pulley Spring Flange, for 271127 ... ..
214206	2795	Rotating Hook Driving Shaft Connection Belt Pulley Spring Flange, for 270169 ...
225257	18362	Thread Unwinder Spool Rest (for two spools) with 201018c, two each 201528h, 228692 and <del>228692</del> <i>22538 (3/58)</i> for 225258 ... ..
225258	18362	Thread Unwinder (for two spools) complete, Nos. 201696h, 225257, 225324, 225326, 225388, <del>250478</del> <i>259658 (4/60)</i> two each 150203, 225391 and three wood screws $\frac{1}{4}$ " No. 12 ...

No.	Plate	Name
225322	18362	Thread Unwinder Thread Guide Rod Washer, for 225324 ...
225324	18362	Thread Unwinder Thread Guide Rod with 208al and 225322, for 225258 ...
225326	18362	Thread Unwinder Thread Guide Position Cup, for 225258 ...
<del>225377</del>	<del>18362</del>	<del>Thread Unwinder Spool Wire, for small spool (2/60) ...</del>
225381	2624	Bobbin Winder Spindle, for 104212 ...
225388	18362	Thread Unwinder Spool Rest Rod, for 225258 ...
<del>225390</del>	<del>18362</del>	<del>Thread Unwinder Thread Cone Holder 2/60 ...</del>
225391	18362	Thread Unwinder Thread Guide, for 225258 ...
225444	2624	Bobbin Winder Stop Latch, for 104212 ...
225453	2624	Bobbin Winder Frame with 202277 and 259660, for 104212 ...
225454	2624	Bobbin Winder Frame Hinge Pin, for 104212 ...
225455	2624	Bobbin Winder Frame Spring, for 104212 ...
225456	2624	Bobbin Winder Frame Spring Plunger for 104212 ...
225458	2624	Bobbin Winder Stop Latch Thumb Lever, for 104212 ...
225459	2624	Bobbin Winder Stop Latch Thumb Lever Hinge Stud, for 104212 ...
225459	2624	Bobbin Winder Stop Latch Thumb Lever Joint Stud, for 104212 ...
225461	2624	Bobbin Winder Tension Bracket with 201499h for 225462 ...
225462	2624	Bobbin Winder Tension Bracket, complete, Nos. 13710, 201572h, 225461 and two 2102, for 104212 ...
227227	2796	Knee Lifter Lifting Rod Spring Collar with 200113f ...
228026	2624	Bobbin Winder Tension Bracket Screw Washer, for 104212 ...
228363	18311	Knee Lifter Rock Lever Hinge Pin, for 228709 ...
228364	18311	Knee Lifter Rock Lever Knee Plate with 350231c, for 228710 ...
228365	18311	Knee Lifter Rock Lever Rod, for 228710 ...
228367	18311	Knee Lifter Rock Lever Stop Stud, for 228709 ...
228370	18311	Knee Lifter Rock Lever Extension with 200530c, for 228710 ...
228386	18311	Knee Lifter Rock Lever Spring, for 228709 ...
228388	18311	Knee Lifter Rock Lever Knee Plate Arm, for 228710 ...
228455	18311	Knee Lifter Rock Lever Position Spring, for 228709 ...

No.	Plate	Name
228478	18311	Drip Pan with four $\frac{3}{8}$ " wire nails ...
228692	18362	Thread Unwinder Spool Pin, for 225257 ...
<del>228699</del>	<del>18362</del>	<del>Thread Unwinder Spool Pin Washer, for 225257 delete (3-58) ...</del>
228707	18311	Knee Lifter Rock Lever Bracket with 200347c and three wood screws $\frac{3}{8}$ " No. 12, for 228709 ...
228709	18311	Knee Lifter Rock Lever Bracket 228707 with 228363, 228367, 228386, 228455 and 228713, for 228710 ...
228710	18311	Knee Lifter Rock Lever, complete, Nos. 228364, 228365, 228370, 228388 and 228709 ...
228713	18311	Knee Lifter Rock Lever with two 350231c, for 228709 ...
230743c	2792	Rotary Take up Guard Cover Hinge Screw Thrust Washer ...
<del>232896</del>	<del>18362</del>	<del>Thread Unwinder Spool Pin Arm Bracket with two 448al 2/60 ...</del>
240231	2795	Feed Driving Eccentric Friction Gib ...
240245	2795	Feed Regulating Stud Retaining Spring ...
240566		Wrench ...
244071		Bobbin Winder Connection Link Hinge Pin Oil Bobbin Winder Frame Oil Packing (wick) for 225453 (2/60) ...
<del>250370</del>	<del>18362</del>	<del>Thread Unwinder Spool Pin for 250373 (2/60) ...</del>
<del>250371</del>	<del>18362</del>	<del>Thread Unwinder Spool Pin Cap (bakelite) for 250373 (2/60) ...</del>
<del>250372</del>	<del>18362</del>	<del>Thread Unwinder Spool Pin Washer for 250373 (2/60) ...</del>
<del>250373</del>	<del>18362</del>	<del>Thread Unwinder Spool Pin, complete, Nos. 10410f and 250370 to 250372 (2/60) ...</del>
<del>250378</del>	<del>18362</del>	<del>Thread Unwinder Spool Pin Arm with 217c and 250379 (2/60) ...</del>
<del>250370</del>	<del>18362</del>	<del>Thread Unwinder Spool Pin Retaining Spring, for 250378 (2/60) ...</del>
259428	2624	Bobbin Winder Brake (leather) for 104212 ...
259429	2624	Bobbin Winder Brake Clamp, for 104212 ...
259430	2624	Bobbin Winder and Tension Bracket Base, for 104212 ...
259658		Thread Unwinder Spool Stand with 200383c for 225258 ...
259660	2624	Bobbin Winder Frame Oil Well Washer, for 225453 ...
263118	2794	Thread Guide (on Needle Bar Bushing) ...
270009	2796	Bed Slide ...
270010	2772	Rotating Hook Bobbin ...
270013	2793	Feed Lifting Connection, for 270014 ...

NUMERICAL LIST OF PARTS

No.	Plate	Name
270014	2793	Feed Lifting Connection 270013 with 270016
270016	2793	Feed Driving Connection Needle Bearing, for 276154 ...
270016	2793	Feed Lifting Connection Needle Bearing, for 270014 ...
270017	2795	Feed Driving Eccentric ...
270026	2795	Feed Regulating Stud Spring ...
270036	2795	Rotating Hook Driving Shaft Oil Lead Wire
270044	2795	Rotating Hook Shaft Thrust Washer, for 276060 ...
270050	2794	Needle Bar with 350445f ...
270055	2794	Needle Bar Connecting Link Guide Block ...
270057	2794	Needle Bar Connecting Stud with 202277 and 350622ax ...
270058	2794	Needle Bar Oiling Felt ...
270080	2792	Thread Retainer (rear) ...
270086	2792	Tension Releasing Pin, for 276049 ...
270124	2794	Needle Bar Bushing (lower) ...
270137	2795	Feed Driving Eccentric Adjusting Disc Spring ...
270140	2795	Feed Regulating Stud ...
270155	2795	Rotating Hook Oil Reservoir Oil Gauge ...
270163	2795	Rotating Hook Shaft Bushing, for 276060 ...
270164	2795	Rotating Hook Shaft End Bearing, for 276060
270169	2795	Rotating Hook Driving Shaft Connection Belt Pulley with 214206 and two 200070c
270261	2794	Needle Bar Bushing (upper) ...
270266	2794	Needle Bar Connecting Link Needle Bearing for 276019 ...
270305	2794	Needle Bar Connecting Link Thrust Washer
270653	2793	Feed Driving Connection Link Needle Bearing, for 276170 ...
(A60) Obsolete, use 272136	2772	Rotating Hook with 143301, 270878 and two 1253al, for 270869 ...
* Obsolete, use 272137	2772	Rotating Hook 270868 with 270871xc and four 1053e, for 270870 ...
" Obsolete use 272128	2772	Rotating Hook 270869 with 270872, 270876 and three 1367e, for 270871 ...
" Obsolete use 272129	2772	Rotating Hook 270870 with 52237 ...
	2772	Rotating Hook Bobbin Case Holder (chromium plated) for 270872 and 270873 ...
	2772	Rotating Hook Bobbin Case 52237 with 270872 ...
	2772	Rotating Hook Thread Guard, for 270873 and 272137 (A60)
(A60) Obsolete, use 272136	2772	Rotating Hook Section, for 270870 ...
	2772	Rotating Hook Oil Retaining Washer (felt) for 270870 and 272136 (A60) ...

NUMERICAL LIST OF PARTS

No.	Plate	Name
270879	2772	Rotating Hook Oil Guard ...
270880	2795	Rotating Hook Shaft Bushing Oil Packing (wick) for 276060 ...
270926	2791	Arm Shaft Connection Belt (reinforced neoprene) ...
270941	2793	Feed Driving Rock Shaft Centre ...
270941	2793	Feed Lifting Rock Shaft Centre ...
270942	2793	Feed Driving Rock Shaft Insert (nylon) for 272116 ...
270942	2793	Feed Lifting Rock Shaft Insert (nylon), for 272118 ...
271127	2791	Arm Shaft Connection Belt Pulley with 200363al, 350492c and two 214206 ...
272106	2793	Feed Bar ...
272107	2793	Feed Bar Hinge Pin ...
272108	2793	Feed Bar Hinge Pin Thrust Washer ...
272109	2793	Feed Bar Lifting Crank ...
272110	2793	Feed Bar Lifting Link ...
272111	2793	Feed Bar Lifting Link Oiling Wick Clamp
272112	2793	Feed Bar Hinge Pin Lubricating Felt ...
272115	2793	Feed Bar Lifting Link Oiling Wick ...
272116	2793	Feed Driving Rock Shaft with two each 200394c and 270942 ...
272118	2793	Feed Lifting Rock Shaft with two 270942 ...
272121	2794	Presser Bar with 176x ...
272122	2794	Presser Bar Position Guide with 350411c ...
272123	2796	Presser Bar Spring ...
272131	2772	Rotating Hook Bobbin Case Holder Position Bracket ...
272142	2791	Arm Shaft Ball Bearing (back) for 276193 ...
272143	2791	Arm Shaft Ball Bearing (front) for 276004 ...
272144	2795	Rotating Hook Driving Shaft Ball Bearing
272150	2792	Rotary Take-up ...
276002	2796	Arm Cover (back) ...
*276003	2791	Arm Shaft, for 276004 ...
276004	2791	Arm Shaft 276003 with 200333c, 200378c, 272154 ...
272154		Rotating Hook Oil Reservoir Cover Washer (fibre) ...
272232		Presser Bar Bushing ...
276014	2794	Knee Lifter Lifting Rod ...
276015	2796	Knee Lifter Lifting Rod with 202302
276016	2796	Knee Lifter Lifting Rod Spring ...
276017	2796	Knee Lifter Rock Frame ...
276018	2794	Needle Bar Connecting Link, for 276019 ...
276019	2794	Needle Bar Connecting Link 276018 with 270266 ...
276020	2794	Needle Bar Connecting Link Hinge Stud ...

27/60

No.	Plate	Name
276021	2791	Needle Bar Connecting Link Hinge Stud Oiling Felt for 276004 ... ..
276022	2791	Needle Bar Connecting Link Hinge Stud Oiling Felt Flange for 276004 ... ..
*276023	2791	Needle Bar Crank with two 200374c for 276004 ... ..
276025	2794	Presser Bar Ball, $\frac{3}{32}$ " diameter ... ..
276026	2794	Presser Bar Bushing <i>No. Cancelled, see 272232</i> <i>(7/6)</i> ... ..
276027	2791	Presser Bar Lifter ... ..
276028	2794	Presser Bar Lifting Releasing Lever Bracket
276032	2792	Rotary Take-up Adjusting Disc for 276033
276033	—	Rotary Take up Adjusting Disc 276032 with 276035 and two 200582x ... ..
276034	2792	Rotary Take-up Clamping Plate ... ..
276035	2792	Rotary Take-up Counterbalance, for 276033
276038	2792	Rotary Take-up Guard Cover Grill ... ..
276043	2792	Rotary Take-up Spacer ... ..
276044	2795	Rotating Hook Driving Shaft ... ..
276045	2795	Rotating Hook Driving Shaft Bushing with 276046 ... ..
276046	2793	Feed Reversing Shaft Crank Hinge Stud Oil Packing (wick) for 276164 ... ..
276046	2795	Rotating Hook Driving Shaft Bushing Oil Packing (wick) for 276045 ... ..
276047	2795	Rotating Hook Driving Shaft Gear (internal teeth) with 200382x <i>ALX 1/6</i> and 201220x <i>ALX 1/6</i> ... ..
276048	2794	Tension Releaser (adjustable) ... ..
276049	2792	Tension, complete, Nos. 13710, 32572, 39652, <i>4/6 1/2 2090</i> <del>52088</del> , 270086 and two 2102 ... ..
276050	2792	Thread Cutter ... ..
276051	2792	Thread Guide ... ..
276052	2792	Thread Retainer (front) ... ..
276053	2791	Needle Bar Connecting Link Hinge Stud Oiling Felt Oil Leader Tube ... ..
276054	2792	Face Plate Thread Guard, for 276226 ... ..
276055	2792	Tension Thread Guide Pin ... ..
276057	2794	Thread Pull-off ... ..
276059	2795	Rotating Hook Shaft for 276060 ... ..
276060	2795	Rotating Hook Shaft Bushing, complete, Nos. 270044, 270163, 270164, 270880, 276059, 276062, 350498e and two 201215d
276061	2795	Rotating Hook Shaft Oil Filter Wick Holder, for 276062 ... ..
276062	2795	Rotating Hook Shaft Oil Filter, complete, Nos. 202423 and 276061 for 276060 ... ..
276153	2793	Feed Driving Connection, for 276154 ... ..
276154	2793	Feed Driving Connection 276153 with 270016

No.	Plate	Name
276157	2793	Feed Reversing Lever with 350477c ... ..
276158	2793	Feed Reversing Lever Connection ... ..
276159	2793	Feed Reversing Lever Hinge Pin ... ..
276160	2793	Feed Reversing Lever Handle ... ..
276162	2793	Feed Reversing Shaft Bushing (back) ... ..
276163	2793	Feed Reversing Shaft Crank with 200040e and 200386c ... ..
276164	2793	Feed Reversing Shaft Crank Hinge Stud with 276046 ... ..
276165	2793	Feed Reversing Shaft Crank Link with 200394c ... ..
276169	2793	Feed Driving Connection Link, for 276170 ... ..
276170	2793	Feed Driving Connection Link 276169 with 270653 ... ..
276171	2793	Feed Driving Connection Link Hinge Pin with 244071 ... ..
276177	2796	Rotating Hook Oil Reservoir Cover ... ..
276178	2796	Rotating Hook Oil Reservoir Cover Gasket <i>Disalite</i> <i>use 276491</i> <i>4-60</i> ... ..
276179	2793	Feed Reversing Shaft Bushing (front) ... ..
276180	2795	Feed Driving Flange with 200333c, 200346c, two each 350562xc and 350578xc ... ..
276181	2793	Feed Reversing Mechanism Support Link ... ..
276182	2793	Feed Reversing Mechanism Support Stud ... ..
*276186	—	Arm ... ..
*276187	—	Bed ... ..
276188	2795	Feed Driving Eccentric Adjusting Disc ... ..
276189	2793	Feed Reversing Shaft with 276191 ... ..
276190	2793	Feed Reversing Shaft Spring ... ..
276191	2793	Feed Reversing Shaft Spring Stud, for 276189
276192	2791	Machine Pulley (aluminium alloy casting) for "V" belt (outside diam. of belt groove 2.9", rim diam. 4") with 350540c and 350541c, for 276193 ... ..
276193	2791	Machine Pulley 276192 with 272142 ... ..
276226	2792	Face Plate with 276054 and four 200586x ... ..
276227	2792	Rotary Take-up Guard ... ..
276228	2792	Rotary Take-up Guard Cover ... ..
276229	2792	Rotary Take-up Guard Cover Spring Catch
276230	2793	Feed Driving Connection Crank with 200040e
276231	2795	Feed Lifting Eccentric with 200382c and 201220c ... ..

No.	Plate	Name
<i>460</i> 276491	—	Rotating Hook Oil Reservoir Cover Gasket

No.	Plate	Name
350231c	18311	Knee Lifter Rock Lever Extension Set Screw, for 228713 ... ..
350231e	18311	Knee Lifter Rock Lever Knee Plate Arm Set Screw, for 228713 ... ..
350231e	18311	Knee Lifter Rock Lever Knee Plate Set Screw, for 228364 ... ..
350390e		Arm Screw ... ..
350411e	2794	Presser Bar Position Guide Pinch Screw, for 272122 ... ..
350435e	2796	Presser Bar Spring Screw (pressure regulating) ... ..
350442e	2794	Presser Bar Lifter Hinge Screw ... ..
350445f	2794	Needle Set Screw for 270050 ... ..
350477e	2793	Feed Reversing Lever Hinge Pin Set Screw, for 276157 ... ..
350492c	2791	Arm Shaft Connection Belt Pulley Position Screw, for 271127 ... ..
350498e	2795	Rotating Hook Shaft Oil Regulating Screw, for 276060 ... ..
350499xc	2796	Presser Bar Spring Screw Stud ... ..
350503alx	2792	Face Plate Screw ... ..
350503alx	2792	Thread Guide Screw ... ..
350503x	2792	Rotary Take-up Guard Cover Spring Catch Screw ... ..
350507e	2793	Feed Driving Connection Crank Hinge Screw
350509e	2793	Feed Reversing Lever Connection Hinge Screw (upper) ... ..
350540e	2791	Machine Pulley Position Screw, for 276192
350541e	2791	Machine Pulley Set Screw, for 276192 ... ..
350550al	2794	Needle Bar Bushing (upper) Set Screw ... ..
350562xc	2795	Feed Driving Eccentric Friction Gib Adjusting Screw Set Screw, for 276180 ... ..
350569e	2793	Feed Reversing Lever Stop Pin ... ..
350578xc	2795	Feed Driving Eccentric Friction Gib Adjusting Screw, for 276180 ... ..
350622alx	2794	Needle Bar Connecting Stud Pinch Screw for 270057 ... ..

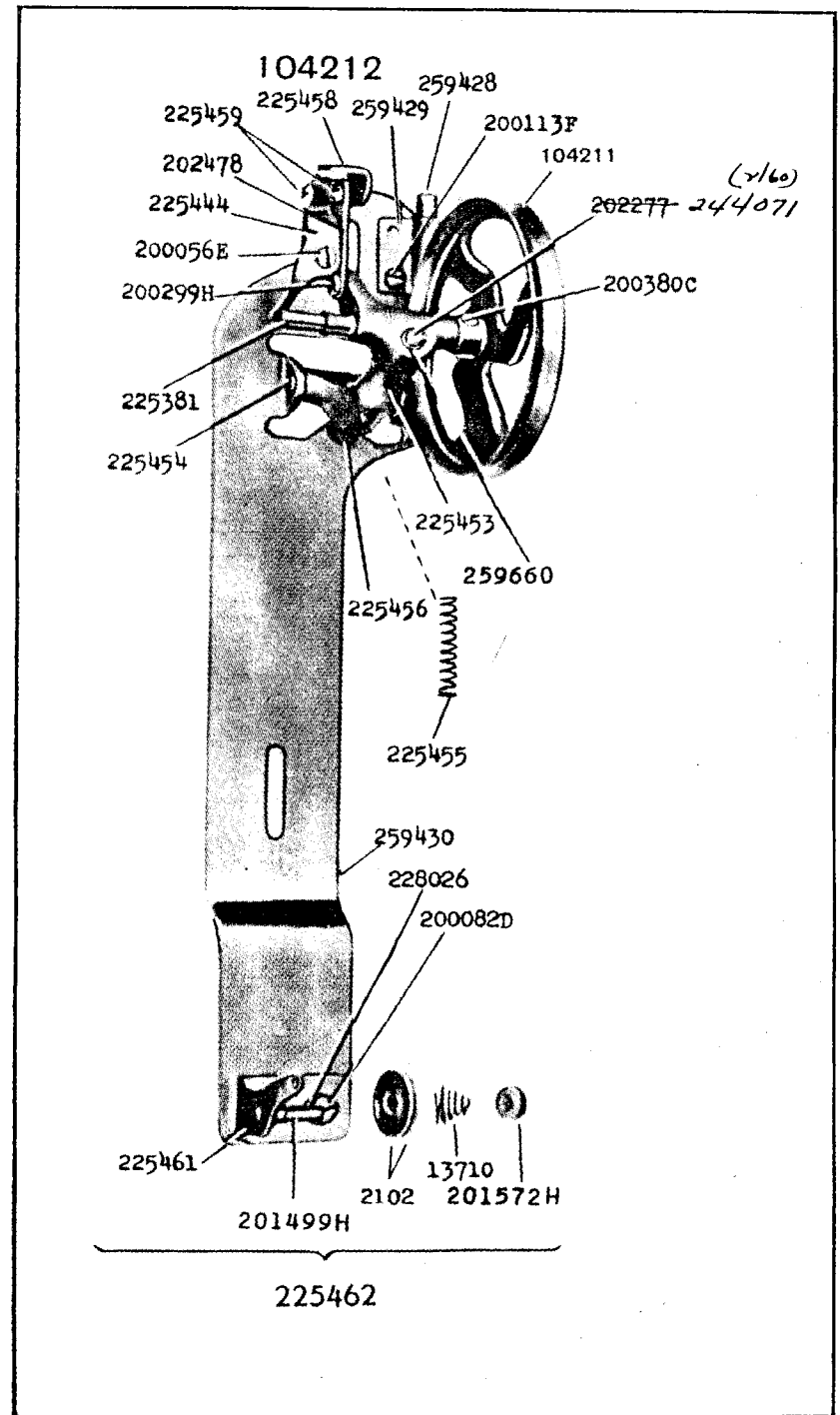

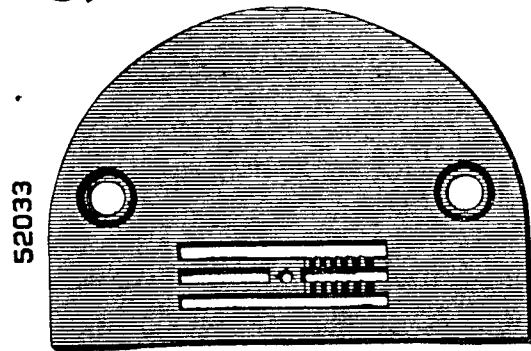
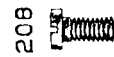
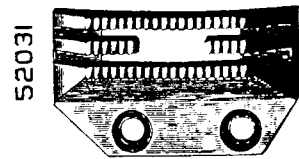
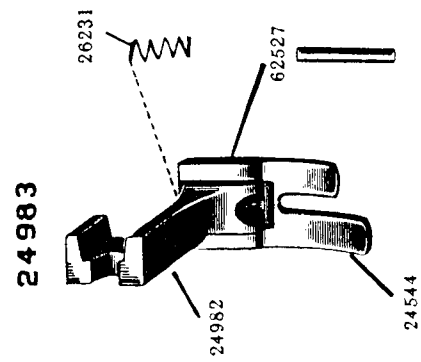

85318.

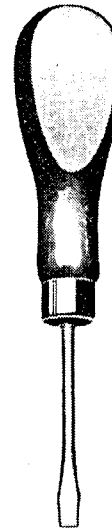

120378.



120342

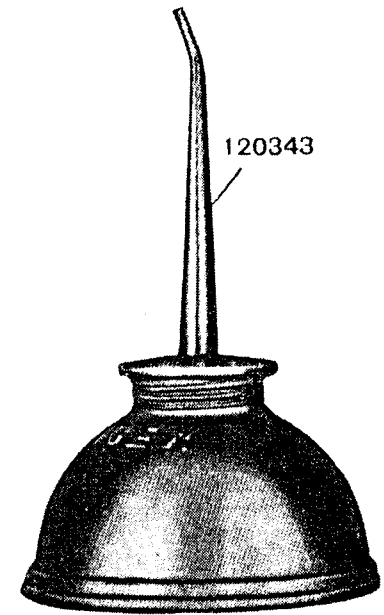

25878.

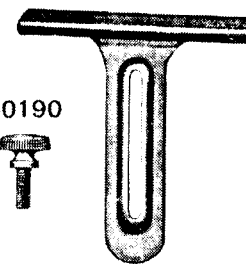

50190



41400



12361

