

**SINGER**  
**61W52**

# LIST OF PARTS



## MACHINE No. 61w52

THE SINGER MANUFACTURING COMPANY

### INDEX

	Page
Accessories .....	12
Bobbin Winder .....	12
Feed Dogs .....	14
Knee Lifter .....	13
Machine No. 61w52 .....	5
Numerical List of Parts .....	23
Presser Feet .....	15
Ruffler .....	20
Throat Plates .....	18

## INSTRUCTIONS FOR ORDERING

In ordering from this list, use ONLY the PART number in the FIRST column.

The number stamped on a Sewing Machine Part is the number of the Single Part only, except when the part includes Set Screws, Clamping Screws, Studs and Rollers Spun on, Small Wires riveted, or Parts soldered together, etc., which it is necessary to furnish in combination.

Every combination of parts sent out has its specific number which, although not stamped on Parts (except in above case), must be used when ordering the combination.

Each number always indicates the SAME PART in whatever list it appears, or for whatever Machine.

The letters after some of the numbers indicate the style of finish only, as follows:

- A. Hardened, Polished, Nickel Plated and Buffed.
- B. Polished, Nickel Plated and Buffed.
- C. Hardened only.
- D. Polished only.
- E. Soft, not polished.
- F. Hardened and Polished.
- H. Blued.
- J. Nickel Plated only.
- R. Marbled.
- X. Black Oxide.
- XC. Hardened and Black Oxide.
- Y. Blade Nickel only.

These letters MUST BE USED when they appear in the list and AFTER the number, as in the list.

In this series:

200001 to 201500 and 350001 to 351500 are Screw Numbers.  
201501 to 201800 and 351501 to 351800 are Nut Numbers.  
201801 to 202000 and 351801 to 352000 are Roller Numbers.  
202001 to 350000 are Numbers of Machine Parts.

The figures in the second column refer only to the plate in which the illustration of the part is shown and are TO BE USED in ordering.

Two or more numbers over a cut indicate that the difference between such parts is not visible in an illustration.

Parts marked with an asterisk (\*) are furnished when repairs are made at the factory.

## LIST OF PARTS COMPLETE FOR

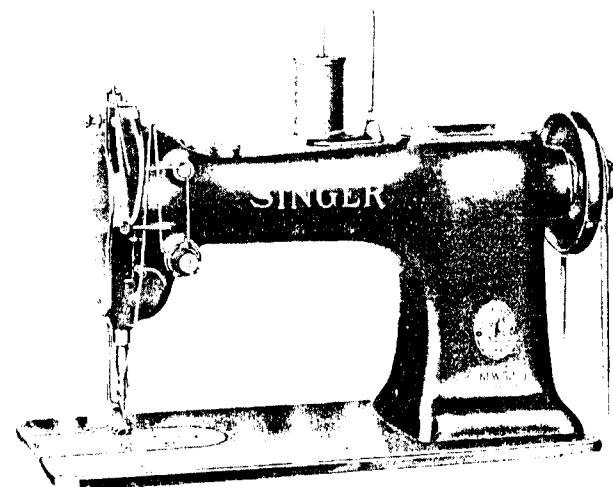

### MACHINE No. 61w52

FOR SHIRTS, CORSETS, UNDERWEAR,  
SHIRT WAISTS, FLANNELS, ETC.

No.	Plate	Name
*207079	-----	Arm with 202135
244070	15101	" Cap with two 244071
244071	15101	" " Oil Wick
200278H	15101	" " Screw
202248	15101	" " Washer
204235	15102	" Position Pin (2)
200010E	15102	" Screw (3)
202005	15102	" " Washer (3)
202249	15101	" Shaft with 200357E and 224392
240802	15101	" " Bushing (back) with 202244
207080	15101	" " " (front) with 202244
200502B	15101	" " " Oil Packing Thumb Screw
202244	15101	Arm Shaft Bushing Oil Packing (wick)
200338C	15101	" " " Set Screw (2)

No.	Plate	Name
202530	15102	Arm Shaft Connection Belt
202252	15102	" " " " Pulley with 200327C, 200602E and two 202253
200602E	15102	Arm Shaft Connection Belt Pulley Position Screw
200327C	15102	Arm Shaft Connection Belt Pulley Set Screw
202253	15102	Arm Shaft Connection Belt Pulley Spring Flange
224392	15101	Arm Shaft Oil Packing (wick)
200357E	15101	" " " " Stop Screw
244063	15101	Balance Wheel (disc) (belt groove 2-1/8 in. diam.) with 200328C and 200335C
200328C	15101	Balance Wheel Position Screw
200335C	15101	" " " Set Screw
*207081	-----	Bed
207082	15108	" Plate (back)
200577XC	15108	" " " Screw (2)
207083	15108	" Slide (front)
202265	15104	Bobbin
*202806	-----	" Case
202267	15104	" " Latch
*202056	-----	" " " Pin
202269	15104	" " " Plunger
202270	15104	" " " Spring
202716	15104	" " Tension Spring
200984C	15104	" " " " Regulating Screw
200594C	15104	" " " " Screw
202533	15104	Bobbin Case complete, Nos. 200594C, 200984C 202056, 202267, 202269, 202270, 202716 and 202806
200459D	15108	Cloth Guide Thumb Screw
202274	15108	Face Plate
202135	15108	" " Position Pin
200462B	15108	" " Thumb Screw
202275	15103	Feed Bar
200641C	15103	" " Hinge Screw (driving)
201522E	15103	" " " " Nut
202276	15103	" " Slide Block
202298	15103	" " " " Crank with 200038C
203124	15103	" " " " " 202298 with 200205F, 201518E and 202276
200038C	15103	Feed Bar Slide Block Crank Pinch Screw
200205F	15103	" " " " Hinge Screw
201518E	15103	" " " " " " Nut
202282	15103	" Dog
200106E	15103	" " Screw (2)
202297	15102	" Driving Connection with 200054E and 202277

No.	Plate	Name
202298	15103	Feed Driving Connection Crank with 200038C
200038C	15103	Feed Driving Connection Crank Pinch Screw
200054E	15102	Feed Driving Connection Hinge Screw
201518E	15102	" " " " " Nut
202277	15102	" " " Oil Packing (wick)
200054E	15102	" " " Pinch Screw
202300	15102	" " Eccentric Regulating Bracket
203124	15102	" " " " " "
		202300 with 202252, two each 201014C and 20125E
201014C	15102	Feed Driving Eccentric Regulating Bracket Hinge Screw
201525E	15102	Feed Driving Eccentric Regulating Bracket Hinge Screw Nut
202301	15102	Feed Driving Eccentric Regulating Bracket Plunger
202302	15102	Feed Driving Eccentric Regulating Bracket Plunger Spring
200607C	15102	Feed Driving Eccentric Regulating Bracket Plunger Spring Stop Screw
201014C	15102	Feed Driving Eccentric Regulating Bracket Stop Screw
201525E	15102	Feed Driving Eccentric Regulating Bracket Stop Screw Nut
200429C	15102	Feed Driving Eccentric Regulating Screw
200387C	15102	" " " " " "
		Check Screw
202303	15103	Feed Driving Rock Shaft
206860	15103	" " " " 202303 with 200641C, 201522E and 202275
203121	15103	Feed Driving Rock Shaft 206860 with 202282 and two 200106E
202305	15103	Feed Driving Rock Shaft Center (2)
200643C	15103	" " " " " " Set Screw (2)
202306	15102	Feed Lifting Connection with 200054E and 202277
202307	15101	Feed Lifting Connection Eccentric with 200382C and 200437C
200437C	15101	Feed Lifting Connection Eccentric Position Screw
200382C	15101	Feed Lifting Connection Eccentric Set Screw
200543C	15102	Feed Lifting Connection Hinge Screw
201518E	15102	" " " " " Nut
202277	15102	" " " Oil Packing (wick)
200054E	15102	" " " Pinch Screw

No.	Plate	Name
202308	15103	Feed Lifting Rock Shaft
202305	15103	" " " " Center (2)
200043C	15103	" " " " " Set Screw
		(2)
202310	15101	Feed Regulating Spindle with 202311, 202443 and 202619
*202311	-----	Feed Regulating Spindle Head
202443	15101	" " " " Pin
202619	15101	" " " " Position Pin
*244010	-----	Hook (sewing)
244011	15104	" 244010 with 200145C, 200596E, 200614C, 202320, 203101, 203775, 206891 and 244014
244012	15104	Hook and Bobbin Case complete, Hex. 202327 and 244011
244013	15102	Hook Counter Balance with 200444C
200444C	15102	" " " Position Screw
206852	15104	" Gib
200614C	15104	" " Hinge Screw
200596E	15104	" " Screw
203101	15104	" Oil Wick
*202320	15104	" Shaft, 11-7/16 In. Long
202321	15102	" " Bushing (back)
200346C	15102	" " " " Set Screw
202322	15102	" " " (front)
200346C	15102	" " " " Set Screw
202323	15102	" " Connection Belt Pulley with 202324 and two 201019C
201018C	15102	Hook Shaft Connection Belt Pulley Set Screw
202324	15102	Hook Shaft Connection Belt Pulley Spring Flange
202360	15102	Hook Shaft Oil Packing (wick) (2)
203775	15104	" " Pin
244014	15104	" Washer
200145C	15104	" " Screw
202327	15102	Knee Lifter Connection Lever
244025	15102	" " " " " with 202447, 244024 and two 200596E
200596E	15103	Knee Lifter Connection Lever Hinge Screw
202447	15102	" " " " " Lifting Rod with 202327
202328	15102	Knee Lifter Connection Lever Lifting Rod Cotter Pin
244024	15102	Knee Lifter Lifting Lever
200596E	15102	" " " " " Hinge Screw
202326	15105	Needle Bar with 200141E
202327	15105	" " Bushing
203123	15105	" " " " 202327 with 202326

No.	Plate	Name
200353C	15105	Needle Bar Bushing Set Screw
202331	15105	" " " " Connecting Link
264718	15105	" " " " Oil Guard
200161D	15105	" " " " " Screw
202323	15105	" " " " Stud with 202354
202354	15105	Needle Bar Connecting Link Stud Oil Packing (wick)
200374C	15105	Needle Bar Connecting Link Stud Set Screw
*200891	15105	Needle Bar Connecting Stud
202329	15105	" " " " 200891 with 200086C and 202320
202320	15105	Needle Bar Connecting Stud Oil Packing (wick)
200086C	15105	Needle Bar Connecting Stud Pinch Screw
202328	15105	" " Crank with 200335C, 200438C, 202323 and two 200374C
203117	15105	Needle Bar Crank 202323 with 202329, 202331 and 202398 to 202400
203121	15105	Needle Bar Crank Friction Washer
200139C	15105	" " " Position Screw
200335C	15105	" " " Set Screw
200141E	15105	" Set Screw
244023	15106	Presser Bar (hollow)
202324	15106	" " 244023 with 200074E
203022	15106	" " Bushing
200353C	15106	" " " Set Screw
202329	15106	" " Lifter
200337C	15106	" " " Hinge Screw
244004	15106	" " Lifting Releasing Lever Bracket
200260D	15106	Presser Bar Lifting Releasing Lever Bracket Guide Screw
200304	15106	Presser Bar Lifting Releasing Lever Bracket Spring
202327	15106	Presser Bar Position Guide
202328	15106	" " " " Lever with 200096E
200096E	15106	Presser Bar Position Guide Lever Pinch Screw
200262C	15106	Presser Bar Position Guide Set Screw
202343	15106	" " " " " (light)
202346	15106	" " " " Stop Rod
200483E	15106	" " " " " Thumb Screw (pressure regu- lating)
200425B	15106	Presser Bar Thumb Screw Thumb Set Screw
202355	15106	" " " " " " "
		Packing (brass)

No.	Plate	Name
202418	15117	Presser Foot
200074F	15106	" " Screw
202068	15101	Spool Holder Base
200575H	15101	" " " Screw
204296	15101	" " Wire
200079H	15101	" " " Hinge Screw
204297	15101	Spool Holder complete, Nos. 200079H, 202068 and 204296
202397	15105	Take-up (auxiliary)
200842E	15105	" " " Screw
202398	15105	" Lever
202399	15105	" " Driving Stud with 202277
202277	15105	" " " " Oil Packing (wick)
202400	15105	" " Hinge Stud with 202423
202423	15105	" " " " Oil Packing (wick)
200383C	15105	" " " " Set Screw
202401	15106	" " Oiling Felt
200132E	15106	" " " " Screw
244048	15107	Tension Disc (back)
244049	15107	" " (front)
202404	15106	" Release Plunger
244061	15107	" " Washer
202407	15107	" Spring
263106	15107	" " Washer
200625F	15107	" Stud with 204925
200061C	15107	" " Set Screw
204925	15107	" " Washer
201572B	15107	" Thumb Nut
244062	15107	Tension complete, Nos. 200625F, 201572B, 202407, 202410, 244048, 244049, 244061 and 263106
202410	15107	Thread Controller Spring
202411	15107	" " " Stop
200132E	15107	" " " " Screw
202413	15107	" Guide
202414	15107	" "
202415	15107	" "
202417	15107	" "
200582H	15107	" " Screw
200355H	15107	" " Set Screw
200368H	15107	" " " "
202091	15107	" Retainer Sleeve
202092	15107	" " Spring
204058	15107	" " Stud
200368H	15107	" " " Set Screw
204059	15107	Thread Retainer complete, Nos. 202091, 202092 and 204058

No.	Plate	Name
202318	15111	Throat Plate, 50 needle hole, for needle sizes 14 and 15, with 202534, 202619 and two 200583H
202534	15109	Throat Plate Bobbin Case Stop
202619	15109	" " " " " Position Pin
200583H	15109	Throat Plate Bobbin Case Stop Screw
200577XC	15109	" " " Screw (2)

Genuine Singer Needles should be used in Singer Machines. These Needles and their Containers are marked with the Company's Trade Mark "SIMANCO."

Needles in Containers marked "For Singer Machines" are not Singer made needles.

## ACCESSORIES

No.	Plate	Name
200157B	15108	Attachment Screw
202205	15104	Bobbin (5)
*225482	-----	" Case Screw Driver Blade
*225483	-----	" " " " Handle
225497	16836	Bobbin Case Screw Driver complete, Nos. 225482 and 225483
231337	16836	Cloth Guide
135 x 1	15105	Needles, three each, sizes 12 and 14
228212	16835	Drip Pan (short) with four 1 in. wire nails
12361	15108	Machine Hinge Connection (2)
41400	16836	" Rest Pin (wood)
120342	16836	Oilier (copper plated) with 120343
120343	16836	" Spout, 3-1/2 in. long
*225484	-----	Screw Driver Blade
*225485	-----	" " Handle
225498	16836	Screw Driver complete (7-1/4 in. long), Nos. 225484 and 225485
225554	16836	Wrench (steel)

## BOBBIN WINDER

(SWINGING AUTOMATIC, RIGHT HAND)

225453	17619	Frame with 202277 and 225438
225454	17619	" Hinge Pin
202277	17619	" Oil Packing (wick)
225438	17619	" " Well Cap
225455	17619	" Spring
225456	17619	" " Plunger
202473	17619	Pulley with 200380C
200380C	17619	" Set Screw
225381	17619	Spindle
225444	17619	Stop Latch
200056E	17619	" " Screw
225458	17619	" " Thumb Lever
225459	17619	" " " " Hinge Stud
225459	17619	" " " " Joint Stud
202478	17619	" " Trip Lever
200299H	17619	" " " " Hinge Screw

## ACCESSORIES

No.	Plate	Name
225461	17619	Tension Bracket with 201499B
200082D	17619	" " Screw
228026	17619	" " " Washer
2102	17619	" Misc
202407	17619	" Spring
201499B	17619	" Stud
201572B	17619	" " Thumb Nut
225462	17619	Bobbin Winder Tension Bracket complete, Nos. 201572B, 202407, 225461 and two 2102
225433	17619	Bobbin Winder and Tension Bracket Base
225392	17619	Universal Bobbin Winder complete, Nos. 200056E, 200082D, 200299H, 202473, 202478, 225391, 225433, 225444, 225453 to 225456, 225458, 225462, 228026, two each 225459 and wood screws 3/4 in., No. 12, R.H.B.

## KNEE LIFTER

228294	16835	Rock Lever with two 356C
228295	16835	" " Bracket with 356C and four wood screws 7/8 in. No. 12
228299	16835	Rock Lever Bracket 228295 with 228294 and 228297
228296	16835	Rock Lever Extension with 200529C
356C	16835	" " " Set Screw
228297	16835	" " Hinge Pin
356C	16835	" " " " Set Screw
228284	16835	" " Knee Plate with 356C
202455	16835	" " " " Arm
356C	16835	" " " " " Set Screw
356C	16835	" " " " " Set Screw
227728	16835	" " Rod with 227729
*227729	-----	" " " Cap
200529C	16835	" " " Set Screw
228298	16835	Knee Lifter Rock Lever complete, Nos. 202455, 227728, 228284, 228296 and 228299

(Other Knee Lifter parts are listed with parts of Machine head.)

## FEED DOGS

No.	Plate	Name
202278	15110	Feed Dog, for binding, for 202811
202281	15109	" " " 202815
202282	15111	" " " general muslin work, for 202818, 202951, 203073 and 203112
202283	15111	Feed Dog, for handkerchief hemming, knit goods and shoe lining, for 202819
202284	15109	Feed Dog, for binding dress shields, for 202812
202287	15113	Feed Dog, for muslin work and gathering, for 202822
202289	15111	Feed Dog, for 202817
202290	15113	" " " special work, for 202824
202292	15113	" " 21 teeth (22 teeth to the inch) for tucking, for 202827
202294	15112	Feed Dog, for tucking, for 202828 and 202830
202295	15113	Feed Dog, for tucking, for 202829
202296	15109	" " " " 202831
202970	15113	" " " general muslin work, for 202969
203071	15112	Feed Dog, for 203056 and 206975
203072	15109	" " " 203053
203083	15110	" " " 203063
203136	15110	" " " 202816
203177	15112	" " " 226000
203417	15109	" " " 203111
207051	15111	" " " handkerchief hemming, knit goods and shoe lining, for 202819
207052	15111	Feed Dog, for handkerchief hemming, knit goods and shoe lining, for 202819
207053	15111	Feed Dog, for shirt, collar and cuff work, for 202817
207054	15111	Feed Dog, for shirt, collar and cuff work, for 202817
207055	15111	Feed Dog, for general muslin work, for 202818, 202951, 203073 and 203112
207056	15111	Feed Dog, for general muslin work, for 202818, 202951, 203073 and 203112
207075	15113	Feed Dog, for leather work, for 203076
225977	15110	" " " for 225622
230625	15112	" " " 230749 and 230833

## PRESSER FEET

No.	Plate	Name
26608	15114	Presser Foot Plate (glass)
202364	15114	" " for 1/32, 1/16 and 3/32 in. stitching margins, for collar and cuff work
202356	15114	Presser Foot, for binding
202361	15114	" " " "
202368	15114	" " (deep grooved) (grooved to left of needle hole), from 4 to 16 cords to the in., as ordered, for top cording
202369	15114	Presser Foot (deep grooved) (grooved to left of needle hole), from 4 to 16 cords to the in., as ordered, for top cording
202370	15114	Presser Foot (deep grooved) (grooved to right of needle hole), from 4 to 16 cords to the in., as ordered, for top cording
202373	15117	Presser Foot, for gathering
202375	15117	" " " mattress binding
202376	15117	" " " " "
202390	15117	" " " front steel stitching in corset work
202418	15117	Presser Foot
202429	15117	" " (split), for gathering
202177	15117	" " "
202179	15117	" " for 1/16 in. stitching margin for collar and cuff work
202187	15117	Presser Foot, for tuck marking or creasing
202198	15116	" " for laying tucks
202199	15116	" " " " narrow tucks
206528	15118	" " " stitching margins 1/32, 1/16 and 3/32 inch
206785	15116	Presser Foot
206786	15116	" " (split)
206787	15118	" " for stitching margins from 1/32 to 1/4 in., in steps of 1/32 inch
206788	15115	Presser Foot
206791	15116	" " for use with English Binder
206792	15118	" " " stitching margins from 1/16 to 1/4 in., in steps of 1/32 inch
206794	15116	Presser Foot, for tailoring work
206841	15116	" " " binding



## PRESSER FEET

No.	Plate	Name
206992	15116	Presser Foot, for tuck marking or creasing
225508	15115	Presser Foot, for gathering
225621	15115	" " " " " "
225690	15116	" " from 4 to 16 cords to the in., as ordered, for top and bottom cording
225702	15120	Presser Foot, for Welts
225723	15115	" " " " " "
225792	15115	" " " " " "
225798	15115	" " " " " "
225862	15118	" " for stitching margins from 1/16 to 1/4 in., in steps of 1/32 in., for collar and cuff work
225949	15120	Presser Foot, for Welts
226029	15115	" " " " " " " darning
229597	15118	" " stitching margins from 1/8 to 5/16 in., in steps of 1/32 in., for open bosom shirts
229856	15115	Presser Foot
229857	15115	" " " " " "
229858	15120	" " " " " "
229880	15120	" " for binding suspenders
231255	15120	" " " " " "
206842	15120	" " Cleft Holder
206998	15120	" " Holder with 200543H, for Presser Bar 202335 as a substitute for Compound Presser Bar 202514
200543H	15120	Presser Foot Screw
202366	15118	" " for stitching margins from 5/32 to 5/16 in., in steps of 1/32 in., with 200175H and 202810
206790	15118	Presser Foot, for stitching margins from 1/16 to 1/4 in., in steps of 1/32 in., with 200904E and 202909
229871	15118	Presser Foot (right hand spring guide), stitching margins from 1/32 to 1/8 in., in steps of 1/32 in., with 200175H and 202807. Order margin required.
202809	15118	Presser Foot Adjustable Spring Guide
200904E	15118	" " " " " " " Screw
202807	15118	" " Spring Guide
202810	15118	" " " " " " " "
200175H	15118	" " " " " " " Screw
203037	15118	" " Plate with 231235 to 231237 and six 200175H
202572	15118	Presser Foot Hinge Pin

## PRESSER FEET

No.	Plate	Name
231235	15118	Presser Foot Strip Guide with 200488F
231236	15118	" " " " " Bar
231237	15118	" " " " " " " Plate
200175H	15118	" " " " " " " Screw
200488F	15118	" " " " " " " Thumb Screw
231238	15118	Presser Foot (hinged) (adjustable) complete, for strips 13/32 to 1-1/4 in., Nos. 202572, 202924 and 203037, for stitching shoe facings
202090	15119	Presser Foot Hinge Pin
202009	15119	" " " " " " " Plate, for 229864
202010	15119	" " " " " " " 229865
202011	15119	" " " " " " " 229867
202012	15119	" " " " " " " 229868
202024	15119	" " " " " " " 229869
202024	15119	" " " " " " " 202272
202025	15119	" " " " " " " 202271
202322	15119	" " " " " " " 202272
229865	15119	" " " " " " " 202361
202324	15118	" " " " " " " Shank
202331	15119	Presser Foot (hinged) complete, 46 needle hole, Nos. 202090, 202924 and 229865, for knit goods
202371	15119	Presser Foot (hinged) complete, Nos. 202090, 202924 and 203035, for umbrella hemming
202372	15119	Presser Foot (hinged) complete, Nos. 202090, 202924 and 203034, for handkerchief hemming
202323	15119	Presser Foot (hinged) complete, 50 needle hole, Nos. 202090, 202924 and 203322
229863	15119	Presser Foot (hinged) complete, Nos. 202090, 202924 and 203010, for overalls and tailoring
229864	15119	Presser Foot (hinged) complete, Nos. 202090, 202924 and 202009
229865	15119	Presser Foot (hinged) complete, Nos. 202090, 202924 and 203024, for tailoring
229867	15119	Presser Foot (hinged) complete, Nos. 202090, 202924 and 203011, for overalls
229868	15119	Presser Foot (hinged) complete, Nos. 202090, 202924 and 203012

## THROAT PLATES

No.	Plate	Name
202811	15110	Throat Plate, 50 needle hole, for needle sizes 14 and 15, with 202534, 202619 and two 200583H, for binding corsets and similar work, for 202278
202812	15109	Throat Plate, 46 needle hole, for needle sizes 16 and 18, with 202534, 202619 and two 200583H, for 202284
202815	15109	Throat Plate, 53 needle hole, for needle sizes 12 and 13, with 202534, 202619 and two 200583H, for tucking work, for 202281
202816	15110	Throat Plate, 50 needle hole, for needle sizes 14 and 15, with 202534, 202619 and two 200583H, for top cording, for 203136
202817	15111	Throat Plate, 60 needle hole, for needle sizes 8 and 9, with 202534, 202619 and two 200583H, for fine shirt work, for 202289, 207053 and 207054
202818	15111	Throat Plate, 50 needle hole, for needle sizes 14 and 15, with 202534, 202619 and two 200583H, for 202282, 207055 and 207056
202819	15111	Throat Plate, 50 needle hole, for needle sizes 14 and 15, with 202534, 202619 and two 200583H, for 202283, 207051 and 207052
202822	15113	Throat Plate, 50 needle hole, for needle sizes 14 and 15, with 202534, 202619 and two 200583H, for muslin work and gathering, for 202287
202824	15113	Throat Plate, 50 needle hole, for needle sizes 14 and 15, with 202534, 202619 and two 200583H, for special work, for 202290
202827	15113	Throat Plate, 53 needle hole, for needle sizes 12 and 13, with 202534, 202619 and two 200583H, for 202293
202828	15112	Throat Plate, 53 needle hole, for needle sizes 12 and 13, with 202534, 202619 and two 200583H, for tucking with Tick Folder, for 202294

## THROAT PLATES

No.	Plate	Name
202829	15112	Throat Plate, 53 needle hole, for needle sizes 12 and 13, with 202534, 202619 and two 200583H, for special tucking, for 202295
202830	15112	Throat Plate, 53 needle hole, for needle sizes 12 and 13, with 202534, 202619 and two 200583H, for 202294
202831	15109	Throat Plate, 50 needle hole, for needle sizes 14 and 15, with 202534, 202619 and two 200583H, for 202296
202851	15111	Throat Plate, 56 needle hole, for needle sizes 10 and 11, with 202534, 202619 and two 200583H, for 202282, 207055 and 207056
202869	15113	Throat Plate, 50 needle hole, for needle sizes 14 and 15, with 202534, 202619 and two 200583H, for fine shirt work, for 202970
203053	15109	Throat Plate, 53 needle hole, for needle sizes 12 and 13, with 202534, 202619 and two 200583H, for 203072
203056	15112	Throat Plate, 50 needle hole, for needle sizes 14 and 15, with 202534, 202619 and two 200583H, for tucking, for 203071
203063	15110	Throat Plate, 50 needle hole, for needle sizes 14 and 15, with 202534, 202619 and two 200583H, for special work, for 203083
203073	15111	Throat Plate, 46 needle hole, for needle sizes 16 and 18, with 202534, 202619 and two 200583H, for 202282, 207055 and 207056
203111	15109	Throat Plate, 50 needle hole, for needle sizes 14 and 15, with 202534, 202619 and two 200583H, for regular cloth work, for 203417
203113	15111	Throat Plate, 40 needle hole, for needle sizes 20 and 22, with 202534, 202619 and two 200583H, for general muslin work, for 202282, 207055 and 207056
206975	15112	Throat Plate, 50 needle hole, for needle sizes 14 and 15, with 202534, 202619 and two 200583H, for 203071
207076	15113	Throat Plate, 50 needle hole, for needle sizes 14 and 15, with 202534, 202619 and two 200583H, for 207075

## THROAT PLATES

No.	Plate	Name
225622	15110	Throat Plate, 53 needle hole, for needle sizes 12 and 13, with 200554, 200619 and two 200582H, for 224977
226000	15112	Throat Plate, 53 needle hole, for needle sizes 12 and 13, with 200554, 200619 and two 200583H, for top and bottom cording, for 203473
230749	15112	Throat Plate, 50 needle hole, for needle sizes 14 and 15, with 201566B, 200634 and two 200583H, for 230623
230833	15112	Throat Plate, 50 needle hole, for needle sizes 14 and 15, with 201566B, 200634 and two 200583H. Used with Cord Covering Attachment, for 230625
201566B	15112	Cord Guide and Strip Folder Thumb Nut, for 230749 and 230833
202534	15109	Throat Plate Bobbin Case Stop
200582H	15110	" " " " " Screw
200583H	15109	" " " " " " "
244026	15110	" " " " " " Position Pin
200619	15109	Throat Plate Bobbin Case Stop Locking Pin

## RUFFLER

WITH SEPARATING BLADE AND DISENGAGING LEVER TO SWITCH THE RUFFLING BLADE OUT OF OR IN TO ACTION FOR INTERMITTENT RUFFLING SUCH AS YOKING SHIRTS, ETC.

225843	15121	Driving Lever
200255D	15121	" " " " " Hinge Screw
225944	15121	" " " " " Spring
201334D	15121	" " " " " Adjusting Nut
225945	15121	Frame with 225949
225946	15121	Guide (left) with 225946 and two 200173B
225947	15121	" (right) with 225946 and two 200173B
Note: Nos. 225946 and 225947 are sent only on order.		
200176D	15121	Guide Screw
225948	15121	Needle Bar Collar (for driving 225947)
201656	15121	" " " " " Roller
200157F	15121	" " " " " Screw
225950	15121	Needle Bar Collar complete, Nos. 200157F, 201656 and 225948
225951	15121	Ruffling Blade
225952	15121	" " " " " Clamp
200173H	15121	" " " " " Screw
225953	15121	" " " " " Lever with 225952, 225954 and two 200173H

No.	Plate	Name
200465F	15121	Ruffling Blade Lever Adjusting Thumb Screw
225954	15121	Ruffling Blade Lever Adjusting Thumb Screw Bushing
201333C	15121	Ruffling Blade Lever Adjusting Thumb Screw Wing Nut
225955	15121	Ruffling Blade Switching Lever
200310C	15121	" " " " " Hinge Screw
225959	15121	" " " " " Stop Pin
225956	15121	Separating Blade
200173D	15121	" " " " " Screw
225957	15121	Ruffler complete, Nos. 200176D, 200255D, 200310C, 200465F, 201334D, 201333C, 225943 to 225945, 225950, 225951, 225952 and 225955

Genuine Singer Needles should be used in Singer Machines. These Needles and their Containers are marked with the Company's Trade Mark "SINGER".

Needles in Containers marked "For Singer Machines" are not Singer made needles.



15102 - 3/8

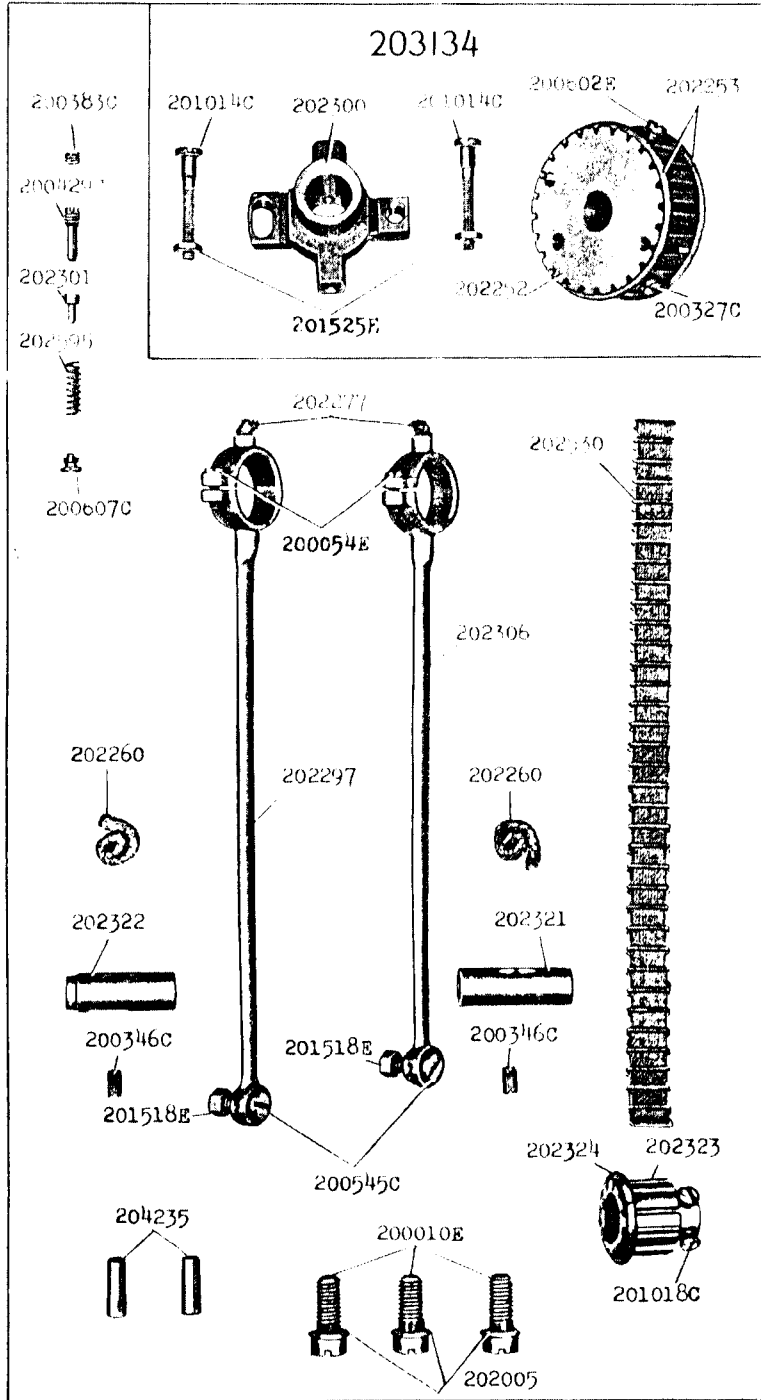

15103 - 3/8

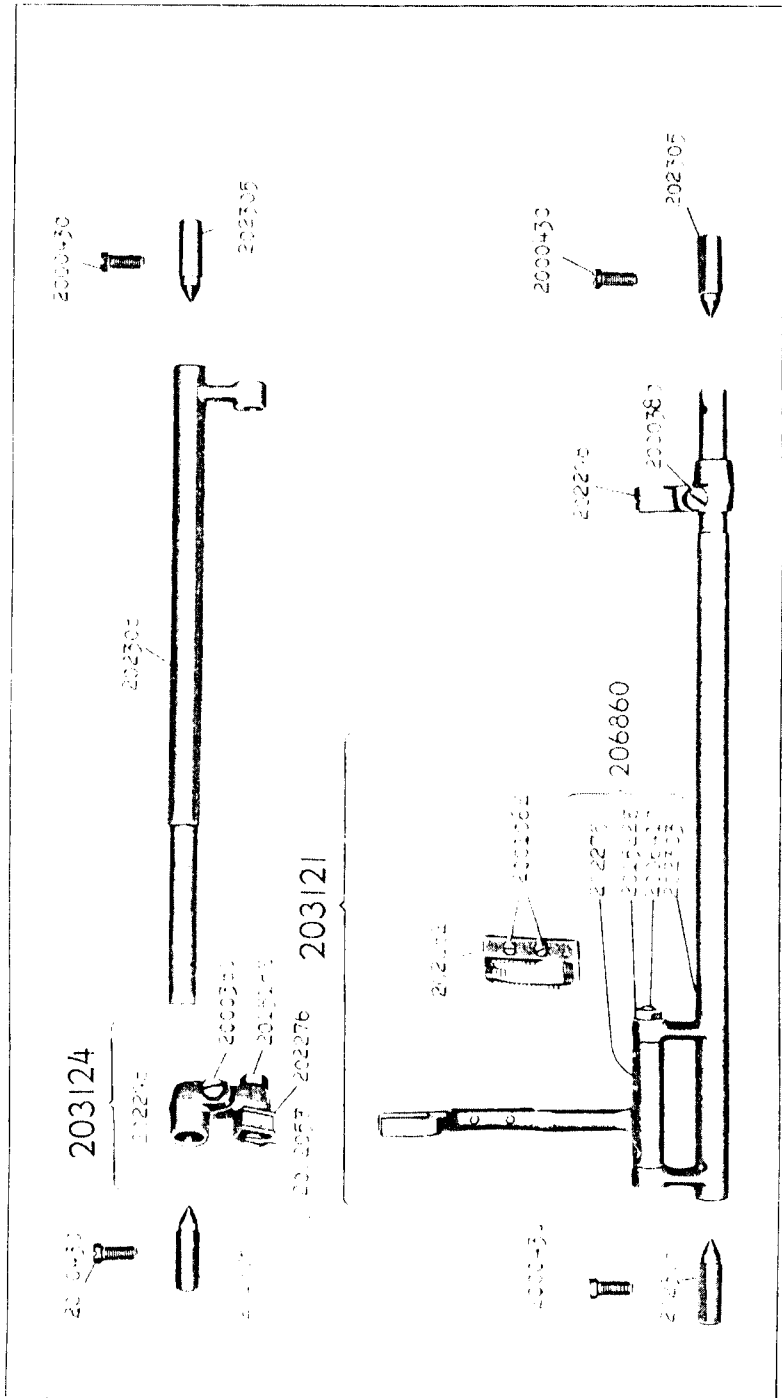





15108 - 1/2

244035

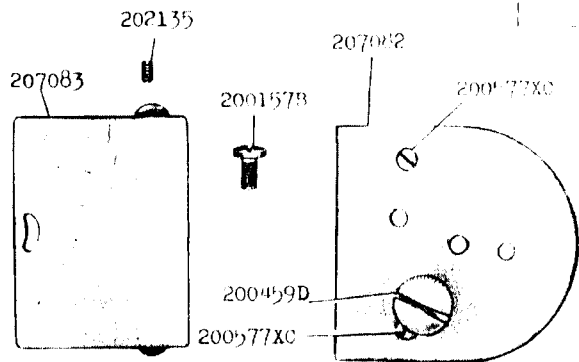
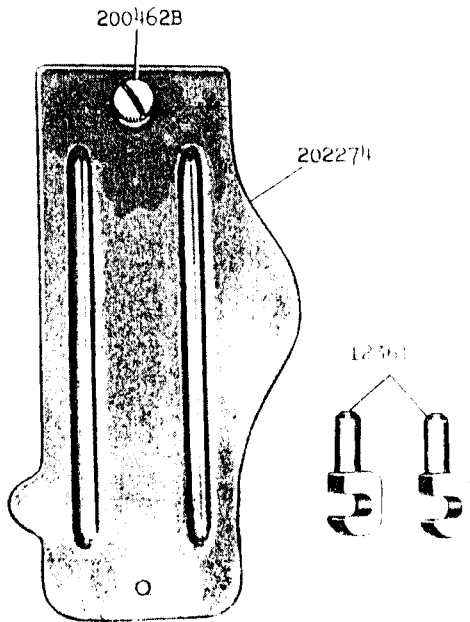
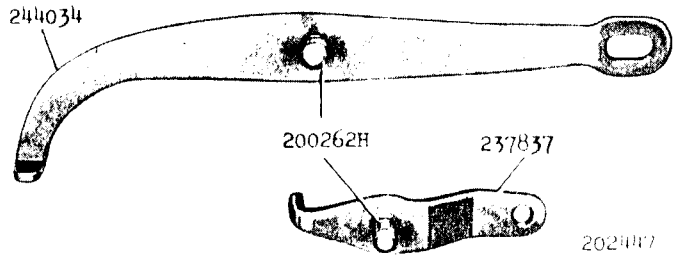

15109 - 5/8

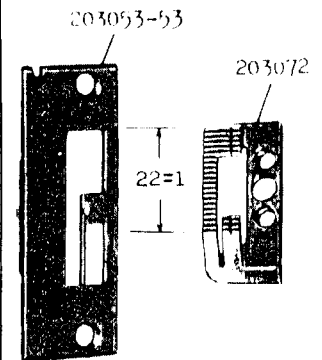
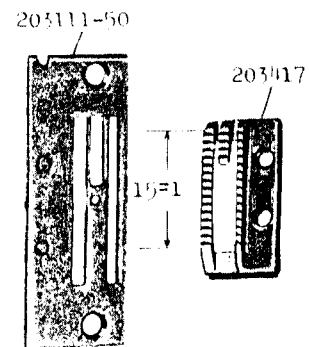
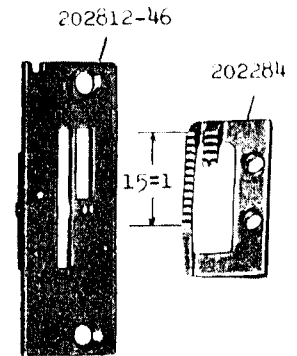
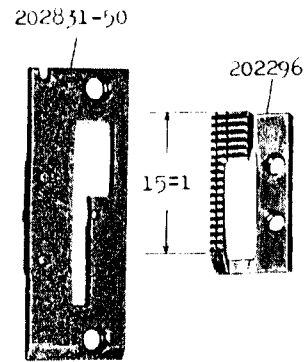
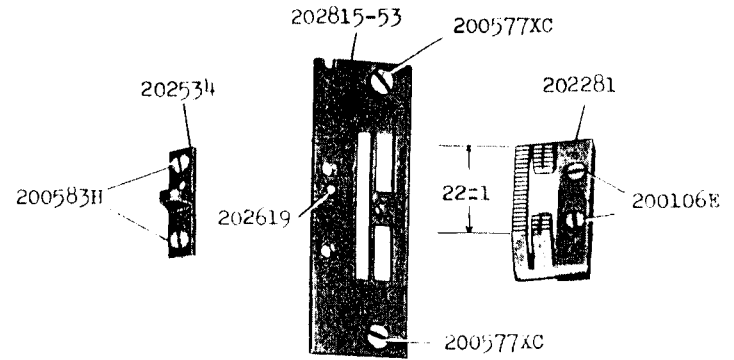



15110 - 5/8

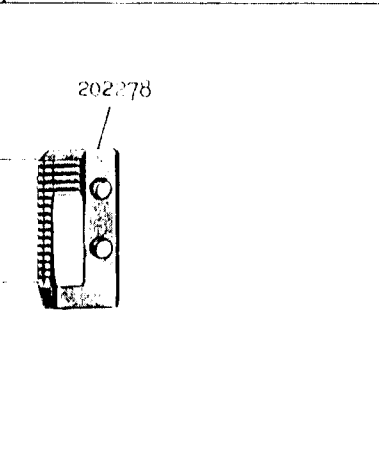
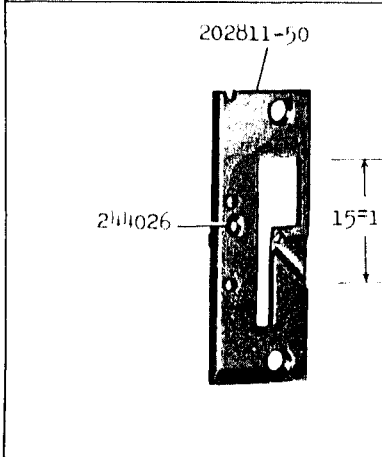
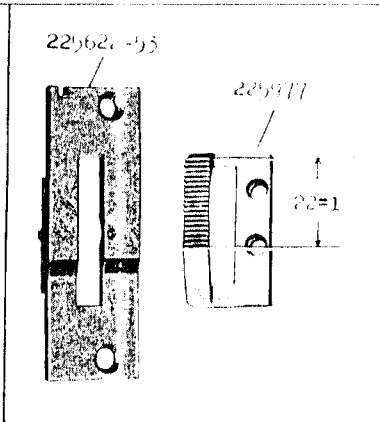
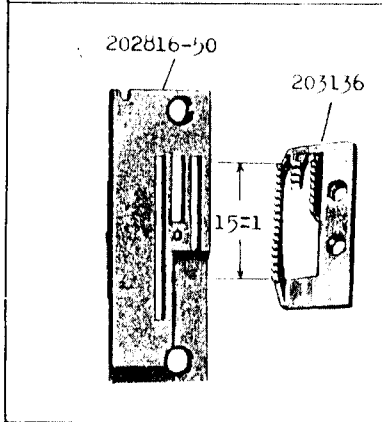
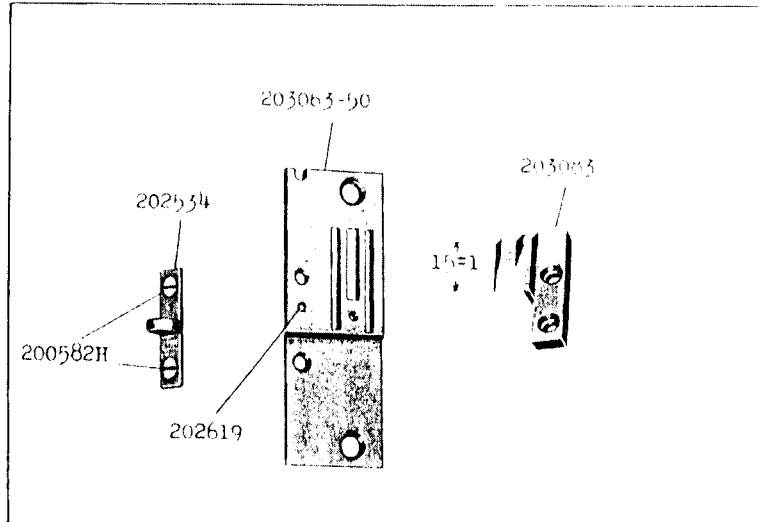

15111 - 5/8

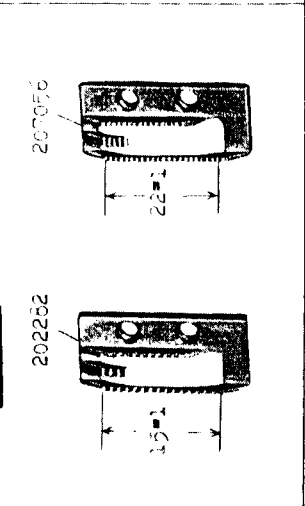
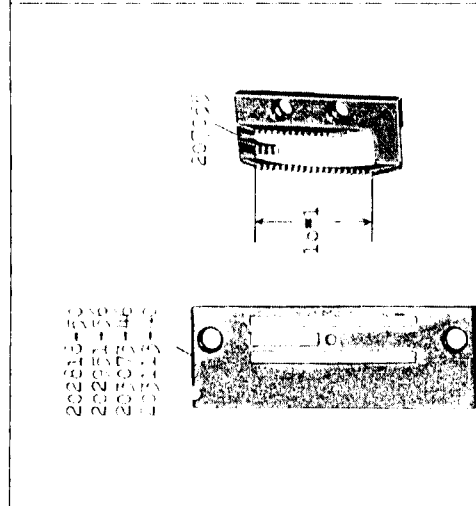
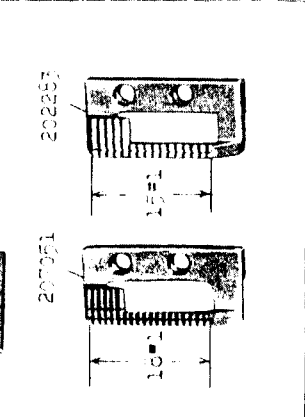
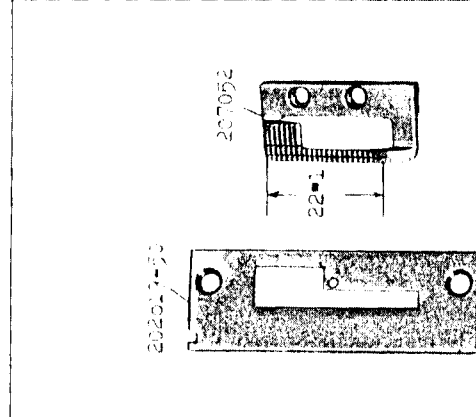
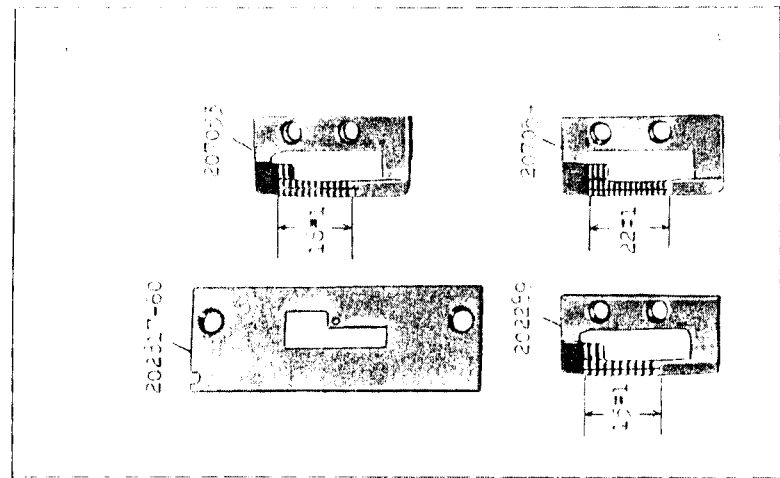

15112 - 5/8

206975-50



203056-50



203071

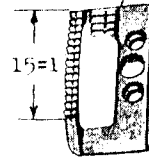

202828-53



202830-53



202294

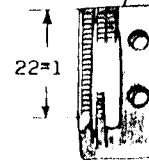

226000-53



203173

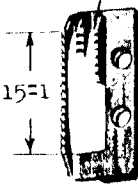

230749-50  
230833-50



230625



201566B

15113 - 5/8

202822-50



202287

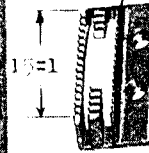

202829-53



202295

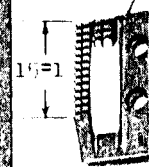

202827-53



202293

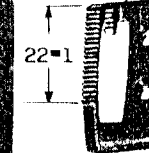

202969-50



202970

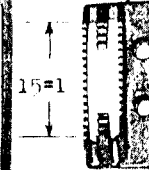

202824-50



202290



207076-50



207075

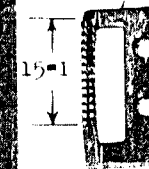





15118 - 5/8

200525

1/32 - 1/16 - 9/32



200757

1/32 - 1/16 - 3/32 - 1/8 - 5/32 - 3/16 - 7/32 - 1/4



206792

1/16 - 3/32 - 1/8 - 5/32 - 3/16 - 7/32 - 1/4



225562

1/16 - 3/32 - 1/8 - 5/32 - 3/16 - 7/32 - 1/4



220597

1/8 - 5/32 - 3/16 - 7/32 - 1/4 - 9/32 - 5/16



200500

5/32 - 3/16 - 7/32 - 1/4 - 9/32 - 5/16

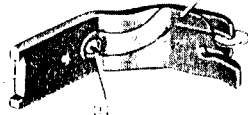

200757

1/16 - 3/32 - 1/8 - 5/32 - 3/16 - 7/32 - 1/4



200571

1/32 - 1/16 - 3/32 - 1/8

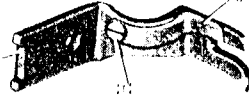

231238

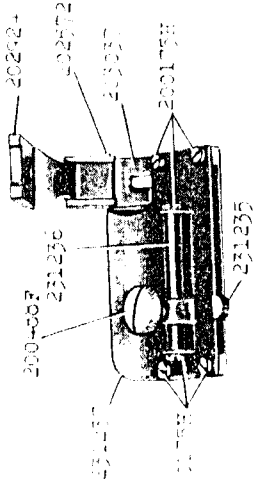

202000

202000

202000

15119 - 5/8

202371

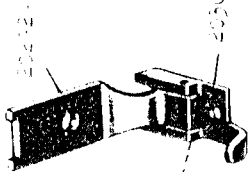

202372



203323 - 50



229863



229864



229867



229865



229868



202351 - 46



202370



202371



203039



203039



203039



203039



203006



203011



203011



203011



203011



15120 - 5/8

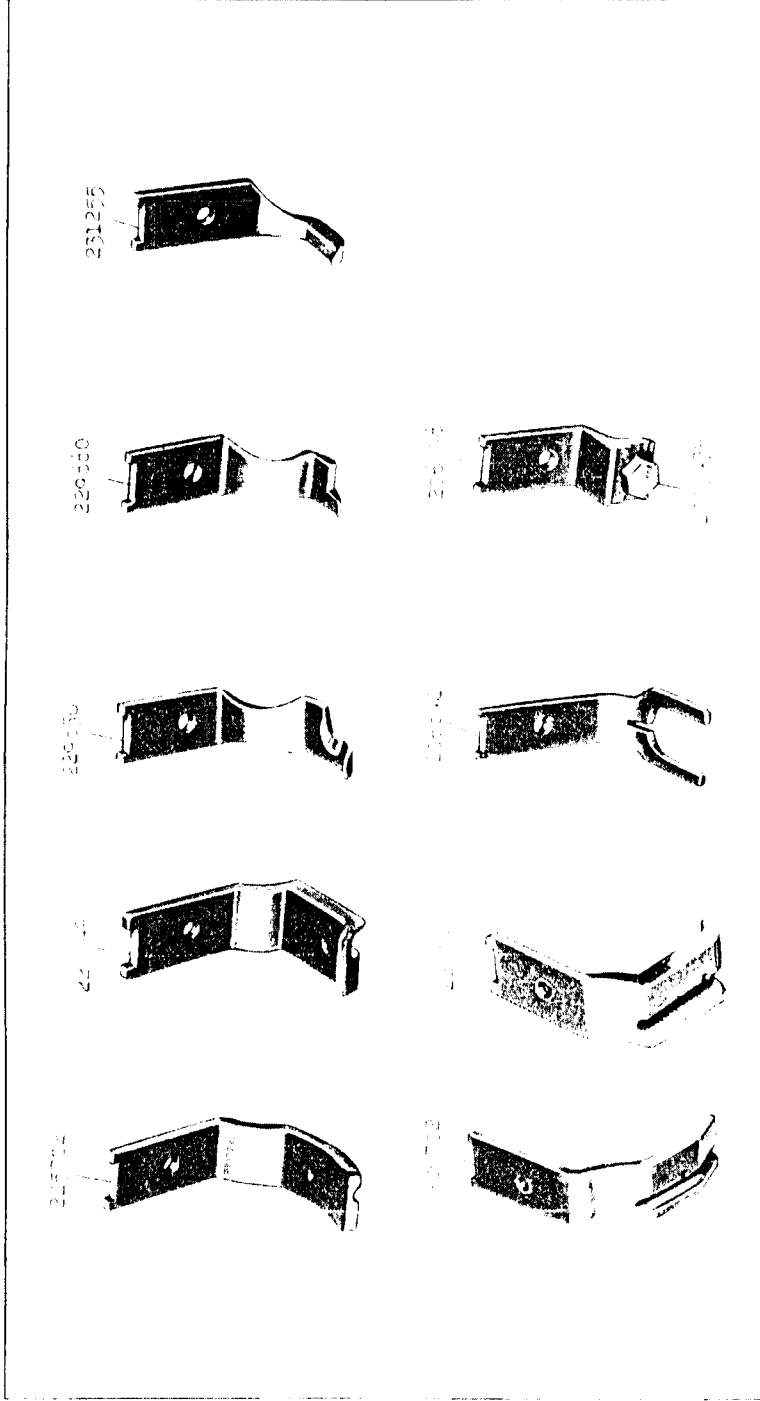

15121 - 2/3

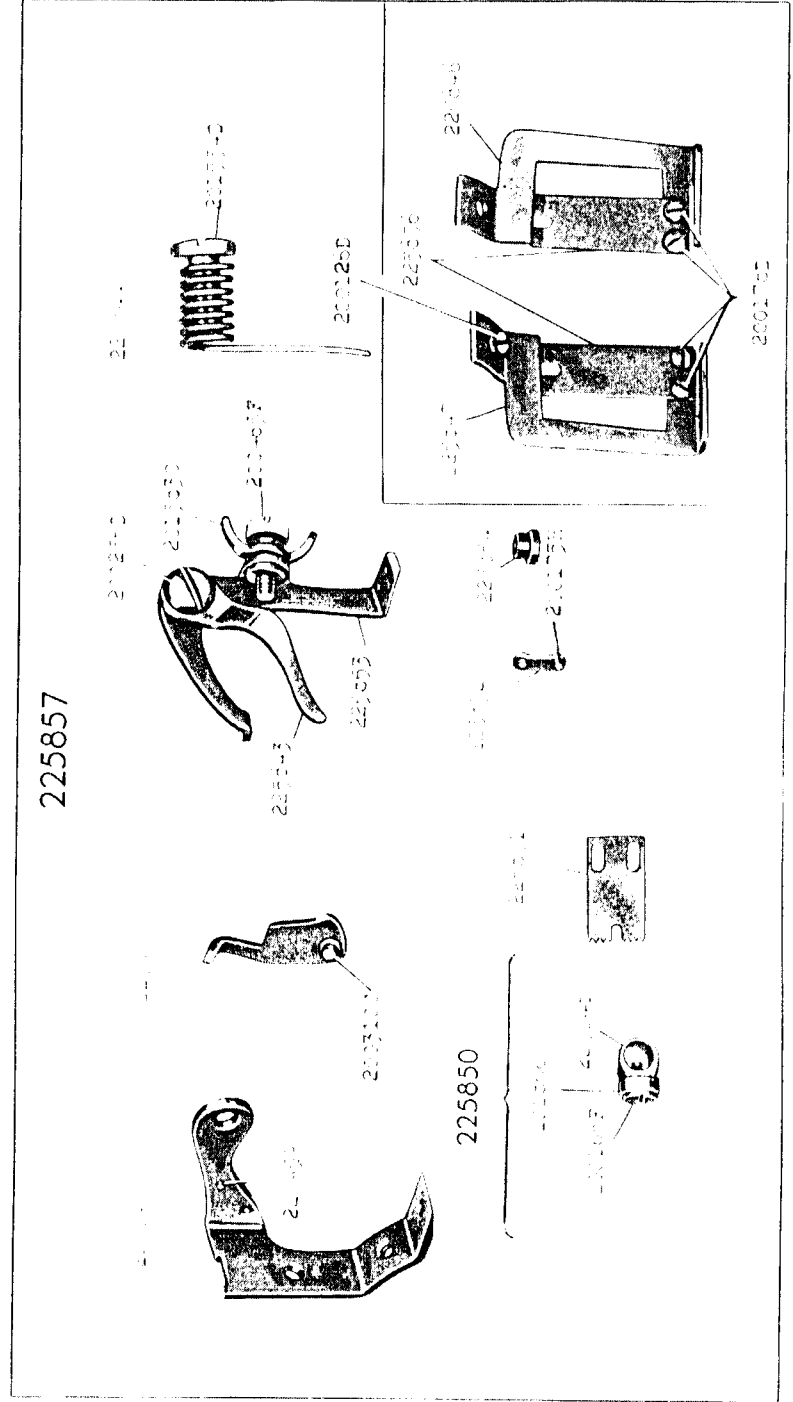

16835 - 1/4

228298

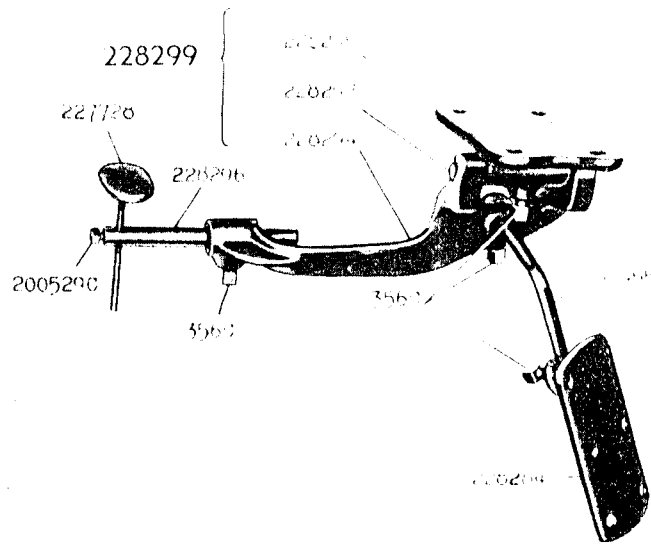

228712

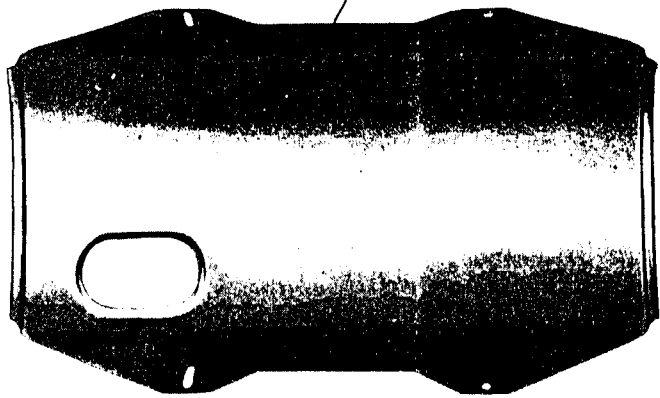

16836 - 1/2

225470

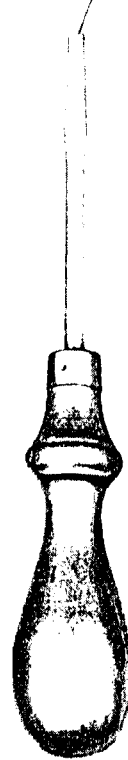

225407



120342

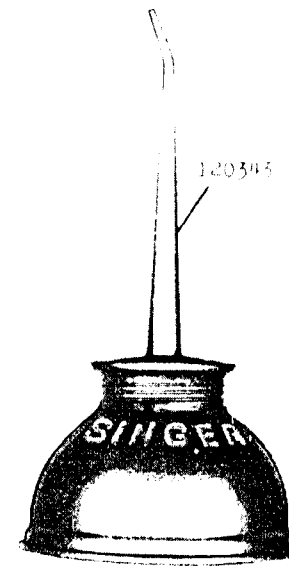

120345

41400



225594

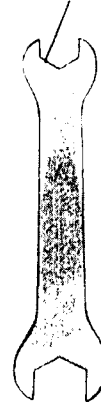

231537

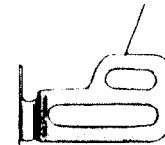

17619 - 1/3

225382

225462

201572B



202407



2102



201499B

225461



225433

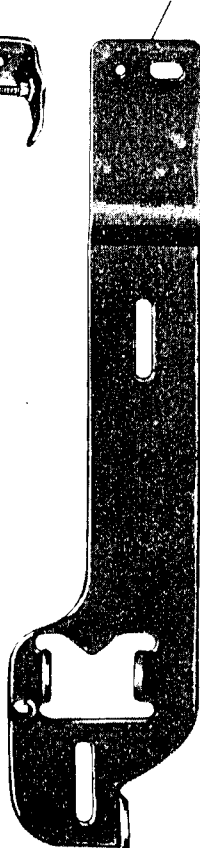

228026



200082D



225456



225455



225454



225453

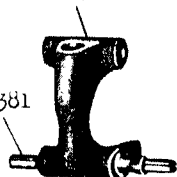

225381

202473

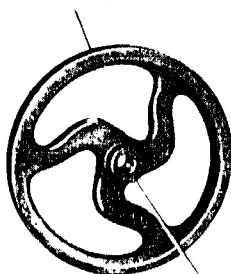

2003800

202277



225438



225459



225458



200299H



202478

225459

225404

