

FORM 8639  
SEPTEMBER, 1919

# PRICE LIST

OF

# PARTS



FOR FAMILY SHOPS

---

## MACHINES

Nos. 66-1 and 66-3

---

THE SINGER MANUFACTURING COMPANY

COPYRIGHT, U.S.A., 1919, BY THE SINGER MANUFACTURING CO.  
ALL RIGHTS RESERVED FOR ALL COUNTRIES.

## INDEX

	PAGE
ACCESSORIES.....	12
ATTACHMENTS.....	12
BOBBIN WINDER.....	19
"    "    (AUTOMATIC).....	18
CORDER.....	13
EDGE STITCHER.....	13
EMBROIDERY ATTACHMENTS.....	13, 14
FEED COVER PLATES.....	15
FELLER.....	15
HAND ATTACHMENT.....	20
"    "    WITH BOBBIN WINDER.....	21
HEMMERS.....	15
HEMSTITCHER.....	15
MACHINE No. 66-1.....	7
"    "    66-3.....	11
NUMERICAL LIST OF PARTS.....	35
OBSOLETE PARTS.....	31
PRESSER FEET.....	15
STAND.....	22
TRIMMINGS FOR CABINET TABLE.....	23
"    "    DRAWING-ROOM CABINET.....	25
"    "    OPEN-SIDE DRAWING-ROOM CABINET.....	27
"    "    PORTABLE CASE.....	30
TUBULAR TRIMMING ATTACHMENT.....	16
TUCK FOLDER.....	16

## INSTRUCTIONS FOR ORDERING

In ordering from this list, use ONLY the part NUMBER in the FIRST column.

The number stamped on a Sewing Machine part is in every case the number of the single part only.

Every combination of parts sent out as such has its specific number, which, although not stamped on the parts, must be used when ordering the combination.

Each number always indicates the SAME PART in whatever list it appears, or for whatever machine.

The letters after some of the numbers indicate the style of finish only, as follows:

- A. Hardened, Polished and Plated.
- B. Polished and Plated
- C. Hardened only.
- D. Polished only.
- E. Soft, not Polished.
- F. Hardened and Polished.
- G.
- H. Blued.
- J. Plated only.
- K. Hardened and Plated.
- L. Brass or Gilt.
- M. Oxidized.
- P. Japanned.
- R. Parkerized.

These letters MUST BE USED when they appear in the list, and AFTER the number as in the list.

In this series

- 1 to 1500 and 50001 to 51500 are Screw Numbers.
- 1501 to 1800 are Nut Numbers.
- 1801 to 2000 are Roller Numbers.
- 2001 to 50000 and 52001 and upward are numbers of Machine Parts.

The figures in the second column refer only to the plates, illustrating the parts, and are NOT TO BE USED in ordering.

Parts marked with an asterisk (\*) are furnished only when repairs are made at factory.

## LIST OF PARTS COMPLETE FOR MACHINE No. 66-1

OSCILLATING HOOK, LINK TAKE-UP.  
FOR FAMILY USE

NO.	PLATE	NAME	EACH
*32616	---	Arm.....	
2002	2902	" Dowel Pin.....	
8203	2901	" Rock Shaft with 122E.....	
122E	2909	" " " Adjusting Screw.....	
8204	2902	" " " Centre (upper).....	
301c	2909	" " " Screw Centre (lower)...	
1508r	2910	" " " " " " Nut	
649E	2909	" Screw.....	
32617	2920	" Shaft.....	
32503	2902	" " " Bushing.....	
443A	2902	" " " Set Screw.....	
32633	2900	" Side Cover (embossed).....	
286B	2909	" " " Thumb Screw.....	
2007	2902	" Spool Pin.....	
8879	2913	" " " Washer (cloth).....	
15282	2922	Balance Wheel, 2½ in. pulley.....	
*32504	---	Bed.....	
32505	2913	" Leg.....	
1129E	2909	" " " Screw.....	
256B	2900	Clamp Stop Motion Clamp Screw.....	
248A	2909	" " " " Stop Screw...	
2020	2900	" " " " Washer.....	
32618	2912	" " " Flanged Bushing....	
1148c	2909	" " " " " " Set Screw.....	
32619	---	Clamp Stop Motion complete, Nos. 248A, 256B, 1148c, 2020 and 32618.....	
32506	2900	Face Plate with 32630.....	
107B	2909	" " " Screw.....	
32630	2902	" " " Thread Guard with 8505.....	
8505	2902	" " " " Rivet...per 100	
1136B	2909	" " " Thumb Screw.....	
32507	2902	Feed Bar with 1944.....	
1944	2902	" " " Roller and Stud.....	
315c	2902	" " " Screw Centre.....	
1519r	2902	" " " " " Nut.....	
32562	2902	" Cam with 1285c.....	
1285c	2902	" " " Set Screw.....	

NO.	PLATE	NAME	EACH
32600	2903	Feed Dog	
191k	2909	" " Screw	
32620	2912	" Forked Connection with 175B	
175B	2909	" " " Adjusting Screw	
1381k	2910	" " " Hinge Screw (eccentric)	
1520j	2910	Feed Forked Connection Hinge Screw Nut	
1832	2909	" " " Roller with 1085E	
1085E	2909	Feed Forked Connection Roller Screw Stud	
32510	2902	Feed Raising Bar with 1944	
1301k	2902	" " " Hinge Screw	
1944	2902	" " " Roller and Stud	
253B	2909	" Regulating Thumb Screw	
8216	2902	" Regulator	
8217	2902	" " Friction Washer	
42E	2902	" " Hinge Screw	
32581	2920	" Rock Shaft	
307c	2909	" " " Screw Centre	
56814	—	" " " " " 307c with 1513J	
1513J	2910	Feed Rock Shaft Screw Centre Nut	
32513	2904	Needle Bar with 32519	
32514	2904	" " Bushing	
1133E	2904	" " " Set Screw	
32515	2904	" " Connecting Link with 930E	
930E	2904	" " " Adjusting Screw	
1130E	2904	Needle Bar Connecting Link Cap Screw	
32580	2911	" " " Stud with 1353c	
1353c	2911	" " " " Set Screw	
32517	2904	" " Crank with 1036c, 1134c and 1259c	
1134c	2904	Needle Bar Crank Position Screw	
1259c	2904	" " " Set Screw	
21360	2921	" " Hole Plug	
32518	2904	" " Thread Guard	
665B	2904	" " " " Screw	
2054	2904	" Clamp with 552c	
552c	2904	" " Thumb Screw	
32519	2904	" Stop Pin	
32520	2905	Oscillating Hook	
32521	2905	" " Bell Crank	
1135J	2905	" " " " Stud	
1642J	2905	" " " " " Collar with 465c	

NO.	PLATE	NAME	EACH
465c	2905	Oscillating Hook Bell Crank Stud Collar Set Screw	
32522	2905	Oscillating Hook Bobbin	
32590	2921	" " " Case with 1172F, 1173D and 32567	
32591	2921	Oscillating Hook Bobbin Case Position Bracket	
32592	—	Oscillating Hook Bobbin Case Position Bracket complete, Nos. 662D, 1137E, 32527, 32528, 32591, 32593, 32598 and 32599	
32593	2921	Oscillating Hook Bobbin Case Cushion Spring	
662D	2905	Oscillating Hook Bobbin Case Cushion Spring Screw	
32598	2921	Oscillating Hook Bobbin Case Position Bracket Oil Pad (felt) per 100	
32599	2921	Oscillating Hook Bobbin Case Position Bracket Oil Pad Holder	
142D	2905	Oscillating Hook Bobbin Case Position Bracket Screw	
1172F	2905	Oscillating Hook Bobbin Case Tension Regulating Screw	
32567	2905	Oscillating Hook Bobbin Case Tension Spring	
1173D	2905	Oscillating Hook Bobbin Case Tension Spring Screw	
32527	2905	Oscillating Hook Bobbin Ejector	
1137E	2905	" " " " Hinge Screw	
32528	2905	Oscillating Hook Bobbin Ejector Spring	
32529	2905	" " Connecting Link	
1132K	2905	" " " " Hinge Screw	
32594	2911	Oscillating Hook Crank with 1485J	
1485J	2911	" " " Clamping Screw	
32531	2901	" " Pitman with two 175J	
175J	2909	" " " Adjusting Screw	
44K	2909	" " " Screw Stud (left)	
1216c	2909	Oscillating Hook Pitman Screw Stud (right)	
1520J	2910	Oscillating Hook Pitman Screw Stud (right) Nut	
216K	2909	Oscillating Hook Pitman Screw Stud (right) Cap Screw	
32569	2900	Oscillating Hook Slide	

NO.	PLATE	NAME	EACH
32570	2902	Oscillating Hook Slide Friction Spring...	
226D	2902	" " " " " Screw	
32558	2900	Presser Bar.....	
32535	2906	" " Guide Bracket with 400k and 453c.....	
400K	2906	Presser Bar Guide Bracket Adjusting Screw.....	
453C	2906	Presser Bar Guide Bracket Set Screw....	
32536	2906	" " Lifter.....	
85E	2906	" " " Screw.....	
3100	2900	" " Spring.....	
2070	2906	" " " Washer.....	
32601	2903	" Foot.....	
32560	2906	" " Holder.....	
1155B	2906	" " " Screw.....	
1158B	2906	" " Thumb Screw.....	
263B	2909	Pressure Regulating Thumb Screw.....	
32621	2911	Slack Thread Regulator.....	
219E	2906	" " " " Screw.....	
2102	2921	Tension Disc.....	
1560B	2906	" Regulating Thumb Nut.....	
32572	2911	" Releasing Disc.....	
32573	2911	" " Lever.....	
97E	2906	" " " Hinge Screw....	
12329	2906	" " " Spring.....	
32574	2911	" " Pin.....	
1274E	2906	" Screw Stud.....	
8238	2906	" Spring.....	
32654	—	Tension complete, Nos. 1274E, 1560B, 8238, 32572, 32574 to 32576 and two 2102.....	
26075	2921	Thread Cutter.....	
8422	2921	" Guard (head of arm).....	
32578	2911	" Take-up Crank.....	
1036C	2904	" " " Set Screw.....	
32541	2904	" " Lever.....	
32542	—	Thread Take-up Lever complete, Nos. 32541, 32543 and 32544.....	
32543	2904	Thread Take-up Lever Hinge Stud.....	
32544	2904	" " " Link.....	
1131C	2904	" " " " Hinge Screw.	
32575	2911	" " Spring.....	
32576	2911	" " " Regulator.....	
448A	2909	" " " " " S e t Screw.....	
32602	2903	Throat Plate for 32600.....	
691A	2909	" " " Screw.....	

## MACHINE No. 66-3

OSCILLATING HOOK, LINK TAKE-UP  
FOR FAMILY USE

This Machine is the same as No. 66-1 with the addition of  
the following:

### HAND ATTACHMENT PARTS

NO.	PLATE	NAME	EACH
*94002	4915	Body.....	
33647	4915	" Bracket.....	
183E	4916	" " Screw.....	
80023	4915	Crank Handle (wood).....	
94012	4915	" " Spindle.....	
8280	4916	" Hinge Pin.....	
8435B	4915	" Lever.....	
8281	4916	" Lock Pin.....	
8282	4916	" " " Spring.....	
94005B	—	Crank complete, Nos. 8435B, 80023 and 94012.....	
94006B	4916	Driver.....	
33643B	—	" Finger.....	
94007B	4916	" " 33643B with 8390, 8391 and 94009.....	
80018	4916	Driver Finger Hinge Pin.....	
94008	4916	" " Lock Pin.....	
8388	4916	" " " Spring.....	
94009	4916	" " Sheath (leather).....	
8390	4916	" " " Plate.....	
8391	4916	" " " Staple.....	
94010	4915	Gear with 8281 and 8282.....	
94011	4915	" Cover.....	
211A	4916	" " Screw.....	
SS380D	4916	" Screw Stud.....	
80027	4916	Pinion.....	
80028	4916	" Dowel Pin.....per 100	
SS381D	4916	" Screw Stud.....	
94001B	—	Hand Attachment complete, Nos. 137B, SS380D, SS381D, 8280, 8388, 33647, 80018, 80027, 80028, 94002, 94005B to 94007B, 94008, 94010, 94011 and two each 183E and 211A.....	
137B	4916	Hand Attachment Screw.....	

## ACCESSORIES

NO.	PLATE	NAME	EACH
36569	2913	Oiler with 36571.....	
36570	—	" 36569, filled with oil.....	
36571	2913	" Spout, 1 $\frac{3}{4}$ in. long, with 36807.....	
36807	2929	" " Washer (leather).....	

## ATTACHMENTS

NO.	PLATE	NAME	EACH
25525	5635	Bias Gauge.....	
36595	5640	Binder.....	
25527B	5635	Cloth Guide.....	
	287B	" " Thumb Screw.....	
35957	5640	Hemmer (adjustable).....	
		Needles (six).....	
32522	2905	Bobbins (five).....	
35958	5640	Quilter.....	
36518	5640	Ruffler.....	
35960	5642	" Shirring Plate.....	
35961	—	" 36518 with 35960.....	
25537	5635	Screw Driver (machine).....	
25538	5635	" " (bobbin case).....	
25539	5635	Stiletto.....	
36655	2924	Tucker Driving Lever.....	
36656	2924	" " " Hinge Stud.....	
36657	2924	" " " Lock Spring.....	
36658	2924	" " " " " Rivet, .....per 100	
36659	2924	Tucker Frame.....	
36660	2924	" Tuck Guide.....	
50238B	2924	" " " Thumb Screw.....	
36661	2924	" " " " " Washer.....	
36662	2924	" " Marker (lower).....	
36663	—	" " " " 36662 with 36664 and two 36648.....	
36664	2924	Tucker Tuck Marker (upper).....	
36665	2924	" " " Clamping Plate.....	
36666	2924	" " " " Rivet .....per 100	
50238B	2924	Tucker Tuck Marker Clamping Plate Thumb Screw.....	
36648	2924	Tucker Tuck Marker Rivet.....per 100	
36667	2924	" " Smoothing Spring.....	

## ATTACHMENTS

NO.	PLATE	NAME	EACH
86354	2924	Tucker Tuck Smoothing Spring Rivet, .....per 100	
36584	2925	Tucker complete, Nos. 36655 to 36657, 36659 to 36661, 36663, 36665 to 36667 and two each 36658, 50238B and 86354.	
35963	5642	Under Braider.....	
35920	—	Set complete, Nos. 287B, 25525, 25527B, 25537 to 25539, 35957, 35958, 35961, 35963, 36584, 36595, five 32522 and six needles.....	

## CORDER

NO.	PLATE	NAME	EACH
35113	2918	Corder Bow.....	
4604	934	" " Rivet.....per 100	
25789	2918	" " Tip.....	
35115	2918	Presser Foot.....	
35114	2918	Corder (bow) complete, for top cording, Nos. 4604, 25789, 35113 and 35115....	

## EDGE STITCHER

NO.	PLATE	NAME	EACH
36867	5642	Edge Stitcher.....	

## EMBROIDERY ATTACHMENT

### FOR ONE THREAD

NO.	PLATE	NAME	EACH
26521	1018	Driving Lever with 26536.....	
22232	1018	" " Friction Washer.....	
26784	1018	" " Hinge Stud.....	
26523	1018	" " Washer.....	
35049	1017	Frame with 35059.....	
35050	1017	" Bracket.....	
36611	1018	Looper.....	
468c	1018	" Set Screw.....	
26528	1018	Scroll with 468c.....	
26529	1018	" Carrier with 26531.....	
22232	1018	" " Friction Washer.....	
26530	1018	" " Hinge Stud.....	
26531	1018	" " Pin.....	
36695	1018	" Cover.....	

NO.	PLATE	NAME	EACH
26533	1018	Scroll Driving Lever with 26534	
26534	1018	" " " Stud	
26535	1017	Spool Pin, for arm of machine	
26536	1018	Thread Bracket	
9859	1018	" " Rivet	per 100
26537	1018	" Eyelet	
26785	1018	" Retaining Spring	
240D	1018	" " " Screw	
35051	1017	Embroidery Attachment complete, Nos. 190D, 240D, 26521, 26523, 26528 to 26530, 26533, 26535, 26537, 26784, 26785, 35049, 36611, 36695 and two 22232	
190D	1017	Embroidery Attachment Screw	

## EMBROIDERY ATTACHMENT

### FOR TWO THREADS

NO.	PLATE	NAME	EACH
35850	934	Body	
35851	934	" Block	
4604	934	" " Rivet	per 100
35485	935	Driving Lever	
35486	935	" " Arm (lower)	
35487	935	" " " (upper)	
35852	934	" " " Guide	
35489	935	" " " Hinge Stud	
35490	935	" " " Spring	
35491	935	" " " Hinge Stud	
35492	935	Thread Carrier (left)	
35493	935	" " " Hinge Stud	
35494	935	" " " (right)	
50139B	935	" " " Hinge Screw	
35495	935	" " " Friction Plate	
35853	934	Embroidery Attachment, Nos. 4604, 35485 to 35487, 35490 to 35495, 35498, 35850 to 35852, 50139B and two 35489	
35497	936	Spool Bracket	
35498	936	" " Stud	
1422B	936	" " Tension Regulating Thumb Screw	
35499	936	Spool Bracket Tension Spring	
35500	936	" " " " Position Pin	
35500	936	" " Thread Guide Pin	
35501	936	" " Wire	
35502	936	" " " Hinge Stud	

NO.	PLATE	NAME	EACH
35503	936	Spool Bracket Wire Hinge Stud Washer	
35504	936	Spool Bracket complete, Nos. 1422B, 35497, 35499, 35502, 35503 and two each 35500 and 35501	
35854	---	Embroidery Attachment complete, Nos. 35504 and 35853	

## FEED COVER PLATES

NO.	PLATE	NAME	EACH
32622	2926	Feed Cover Plate (flat top) for art work	
32589	2926	" " " (oval top) for art work	

## FELLER

NO.	PLATE	NAME	EACH
35833	2923	Feller (foot)	

## HEMMERS

NO.	PLATE	NAME	EACH
35142	---	Hemmer (foot) for $\frac{5}{8}$ in. hem	
28789	2903	" " " $\frac{1}{8}$ in. hem	
28996	---	" " " $\frac{3}{16}$ in. hem	
35554	2923	" " narrow, for chiffon and silk	
35555	---	Hemmer (foot) wide, for chiffon and silk	

## HEMSTITCHER

NO.	PLATE	NAME	EACH
28986	2903	Hemstitcher	

## PRESSER FEET

NO.	PLATE	NAME	EACH
32634	2923	Presser Foot, for stitching on edges and inserting cord	
35506	2903	Presser Foot, for etching	
36074	2927	" " with 665B and 36075, for blind stitch braiding for soutache braid	
36075	2927	Presser Foot Braid Guide	

NOTE: When ordering Nos. 36074 or 36075 send sample of braid for which it is to be used.

## PRESSER FEET

NO.	PLATE	NAME	EACH
665B	2927	Presser Foot Braid Guide Screw	
36081	2927	Presser Foot	
35002	2927	" " Extension	
35003	2927	" " Graduated Adjustable Guide (long, left)	
35004	2927	Presser Foot Graduated Adjustable Guide (long, right)	
35005	2927	Presser Foot Graduated Adjustable Guide (short, right)	
35006	2927	Presser Foot Graduated Adjustable Guide (short, right) flush	
36082	2927	Presser Foot Graduated Adjustable Guide Clamp	
337B	2927	Presser Foot Graduated Adjustable Guide Clamp Screw	
36083	2927	Presser Foot Graduated Adjustable Guide Clamp Lever	
36084	—	Presser Foot with Extension and Graduated Adjustable Guides complete, Nos. 337B, 35002 to 35006 and 36081 to 36083	
36108	2927	Presser Foot, for darning	
36787	2923	" " " gathering	

## TUBULAR TRIMMING ATTACHMENTS

NO.	PLATE	NAME	EACH
35986	2927	Presser Foot (strip folding) with tube	
25539	5635	Stiletto	
35983	2927	Strip Wire	

NOTE: When ordering No. 35983, state size of Attachment with which it is to be used.

35987 — Tubular Trimming Attachment complete, for making  $\frac{3}{8}$  in.,  $\frac{1}{8}$  in. and  $\frac{3}{4}$  in. trimmings, Nos. 25539, 35983 and 35986

NOTE: When ordering No. 35987, state size required.

## TUCK FOLDER

NO.	PLATE	NAME	EACH
225923	2928	Folder	
171A	2929	" Adjusting Screw	
36090	2928	" Arm with 50068E	
50066E	2929	" Screw Stud	

## TUCK FOLDER

NO.	PLATE	NAME	EACH
50067D	2929	Folder Screw Stud Cap Screw	
19044	2929	" " " " " Spring Washer	
1704B	2929	Folder Screw Stud Thumb Nut	
202600	2929	" " " " " Washer	
225926	2928	Space Gauge	
50068E	2929	" " Screw Stud	
1705B	2929	" " " " Thumb Nut	
202603B	2929	" " " " " Washer	
36091	2928	Tuck Folder complete, for small pieces of goods, Nos. 171A, 1704B, 1705B, 19044, 36090, 50066E, 50067D, 202600, 202603B, 225923, 225926 and two 1483H	
1483H	2929	Tuck Folder Thumb Screw	
36093	2927	Presser Foot	

## BOBBIN WINDER (Automatic)

FOR 15282

NO.	PLATE	NAME	EACH
15376	6314	Adjusting Arm	
50058B	6313	" " Screw	
15072	6313	Bobbin Position Pin	per 100
32601	2912	Bracket (belt cover)	
180B	6313	" Screw	
15413	6314	Frame	
50059B	6313	" Hinge Screw	
15286	6313	" Spring	
15287	6313	Friction Ring (rubber)	
15414	6314	Pulley	
32550	2907	Spindle with 15072	
571C	6313	" Worm	
32625	6314	Stop Latch	
50230B	6313	" " Hinge Screw	
15291	6313	" " Spring	
32628	6314	Thread Guide	
50061B	6313	" " Hinge Screw	
15366	6313	" " Spring	
15416	6314	Worm Wheel and Thread Guide Cam	
15424	6314	" " " " " Friction Washer	
50B	6313	Worm Wheel and Thread Guide Cam Screw Stud (eccentric)	



NO.	PLATE	NAME	EACH
1528H	6313	Worm Wheel and Thread Guide Cam Screw Stud Nut.....	
32629	—	Bobbin Winder (automatic) complete, Nos. 50B, 571c, 1528H, 15286, 15287, 15291, 15366, 15376, 15413, 15414, 15416, 15424, 32550, 32604, 32625, 32628, 50058B, 50059B, 50061B and 50230B.....	

## BOBBIN WINDER (Automatic)

FOR 15282

OBSOLETE, USE 32629

NO.	PLATE	NAME	EACH
15376	6314	Adjusting Arm.....	
50058B	6313	“ “ Screw.....	
15072	6313	Bobbin Position Pin.....per 100	
32604	2912	Bracket (belt cover).....	
180B	6313	“ “ Screw.....	
15285	6313	Frame.....	
50059B	6313	“ Hinge Screw.....	
15286	6313	“ Spring.....	
15287	6313	Friction Ring (rubber).....	
15288	6313	Pulley.....	
32550	2907	Spindle with 15072.....	
571c	6313	“ Worm.....	
32625	6314	Stop Latch.....	
50230B	6313	“ “ Hinge Screw.....	
15291	6313	“ “ Spring.....	
32623	6314	Thread Guide.....	
2746	6313	“ “ Cam.....	
233B	6313	“ “ “ Screw.....	
50061B	6313	“ “ Hinge Screw.....	
15366	6313	“ “ Spring.....	
2748	6313	Worm Wheel.....	
15403	—	“ “ 2748 with 233B and 2746... ..	
2749	6313	“ “ Friction Washer.....	
50B	6313	“ “ Screw Stud (eccentric).....	
1528H	6313	“ “ “ “ Nut.....	
32608	—	Bobbin Winder (automatic) complete, Nos. 50B, 571c, 1528H, 2749, 15285 to 15288, 15291, 15366, 15376, 15403, 32550, 32604, 32623, 32625, 50058B, 50059B, 50061B and 50230B.....	

## BOBBIN WINDER

FOR NOS. 2804 AND 32588

OBSOLETE

NO.	PLATE	NAME	EACH
15072	2907	Bobbin Position Pin.....per 100	
32548	2901	Bracket (belt cover).....	
180B	2907	“ “ Screw.....	
32549	2907	Frame.....	
48B	2907	“ Hinge Screw.....	
32564	2907	“ Spring.....	
32557	2907	Pulley.....	
32550	2907	Spindle with 15072.....	
571c	2907	“ Worm.....	
32551	2907	Stop Latch.....	
92B	2907	“ “ Hinge Screw.....	
2442	2907	“ “ Spring.....	
32552	2907	Thread Guide.....	
2746	2907	“ “ Cam.....	
233B	2907	“ “ “ Screw.....	
92B	2907	“ “ Hinge Screw.....	
2747	2907	“ “ Spring.....	
2748	2907	Worm Wheel.....	
15403	—	“ “ 2748 with 233B and 2746... ..	
2749	2907	“ “ Friction Washer.....	
50B	2907	“ “ Screw Stud.....	
1528H	2907	“ “ “ “ Nut.....	
32553	—	Bobbin Winder complete, Nos. 48B, 50B, 571c, 1528H, 2442, 2747, 2749, 15403, 32548 to 32552, 32557, 32564 and two 92B.....	

## BOBBIN WINDER

FOR NOS. 2008 AND 32584

OBSOLETE

This Bobbin Winder is the same as 32553 with the following exceptions:

NO.	PLATE	NAME	EACH
32585	2913	Bracket (belt cover) in place of 32548....	
32586	2921	Pulley, in place of 32557.....	
32587	—	Bobbin Winder complete, Nos. 48B, 50B, 571c, 1528H, 2442, 2747, 2749, 15403, 32549 to 32552, 32564, 32585, 32586 and two 92B.....	

## HAND ATTACHMENT

FOR 32616

OBSOLETE

NO.	PLATE	NAME	EACH
8377	6309	Body.....	
33647	6309	" Bracket.....	
183E	6310	" " Screw.....	
8380	6309	Crank Handle (wood).....	
8433	—	" " Spindle.....	
8434	6309	" " " 8433 with 8382....	
8382	6310	" " " Washer.....	
8280	6310	" Hinge Pin.....	
8435B	6309	" Lever.....	
8281	6310	" Lock Pin.....	
8282	6310	" " " Spring.....	
8436	—	Crank complete, Nos. 8380, 8434 and 8435B.....	
33642	6310	Driver.....	
33643B	—	" Finger.....	
94007B	4916	" " 33643B with 8390, 8391 and 94009.....	
8386	6310	Driver Finger Hinge Pin.....	
8387	6310	" " Lock Pin.....	
8388	6310	" " " " Spring.....	
94009	4916	" " Sheath (leather).....	
8390	6310	" " " Plate.....	
8391	6310	" " " Staple.....	
8392	6309	Gear with 8281 and 8282.....	
8393	6309	" Cover.....	
399A	6310	" " Screw.....	
659D	6310	" Screw Stud.....	
8394	6310	Pinion.....	
2532	6310	" Dowel Pin.....per 100	
660D	6310	" Screw Stud.....	
33646	—	Hand Attachment complete, Nos. 137B, 659D, 660D, 2532, 8280, 8377, 8386 to 8388, 8392 to 8394, 8436, 33642, 33647, 94007B and two each 183E and 399A..	
137B	6310	Hand Attachment Screw.....	

## HAND ATTACHMENT WITH BOBBIN WINDER

FOR 32588

OBSOLETE

NO.	PLATE	NAME	EACH
8377	6309	Body.....	
32609	2912	" Bracket with 8312 and two 145B....	
8312	—	" " Cap (belt cover).....	
145B	2910	" " " Screw.....	
183E	6310	" " " Screw.....	
8380	6309	Crank Handle (wood).....	
8433	—	" " Spindle.....	
8434	6309	" " " 8433 with 8382....	
8382	6310	" " " Washer.....	
8280	6310	" Hinge Pin.....	
15295	2912	" Lever.....	
15296	—	Crank complete, Nos. 8380, 8434 and 15295.....	
8281	6310	Crank Lock Pin.....	
8282	6310	" " " Spring.....	
8313	2916	Driver.....	
8284	2916	" Finger.....	
8285	2916	" " Hinge Pin.....	
8286	2916	" " Lock Spring.....	
233B	2907	" " " " Screw.....	
8392	6309	Gear with 8281 and 8282.....	
8393	6309	" Cover.....	
399A	6310	" " Screw.....	
659D	6310	" Screw Stud.....	
8394	6310	Pinion.....	
2532	6310	" Dowel Pin.....per 100	
660D	6310	" Screw Stud.....	
15072	2907	Bobbin Position Pin.....per 100	
32610	2916	" Winder Bracket.....	
134D	2910	" " " Screw.....	
32611	2916	" " Frame.....	
48B	2907	" " " Hinge Screw.....	
2460	2916	" " Friction Ring (rubber)....	
2461	2916	" " Pulley.....	
32612	2916	" " Spindle with 15072.....	
571C	2907	" " " Worm.....	
32613	2916	" " Stop Latch.....	
92B	2907	" " " " Hinge Screw.....	
2747	2907	" " " " Spring.....	
32614	2916	" " Thread Guide.....	

22 HAND ATTACHMENT WITH BOBBIN WINDER

NO.	PLATE	NAME	EACH
2746	2907	Bobbin Winder Thread Guide Cam	.....
233B	2907	" " " " " Screw	.....
92B	2907	" " " " " Hinge Screw	.....
2747	2907	Bobbin Winder Thread Guide Spring	.....
2748	2907	" " " " " Worm Wheel	.....
15403	—	" " " " " 2748 with 233D and 2746	.....
2749	2907	Bobbin Winder Worm Wheel Friction Washer	.....
50B	2907	Bobbin Winder Worm Wheel Screw Stud (eccentric)	.....
1528H	2907	Bobbin Winder Worm Wheel Screw Stud Nut	.....
32603	—	Hand Attachment complete with Bobbin Winder, Nos. 48B, 50B, 134D, 233B, 571C, 659D, 660D, 1528H, 2460, 2461, 2532, 2749, 8280, 8284 to 8286, 8313, 8377, 8392 to 8394, 15296, 15403, 32609 to 32614 and two each 92B, 183E, 399A and 2747	.....

**STAND**

**ROCKING TREADLE, BALL BEARING PITMAN, CABINET TABLE**

NO.	PLATE	NAME	EACH
25442	6321	Band Wheel, 12½ in. diam., with 972c	.....
46515	6321	" " " " " Crank	.....
46624	—	Band Wheel Crank and Pitman (ball bearing) complete, Nos. 1520E, 25371, 46506 to 46510, 46515, 46655 and six 25362	.....
46511	—	Band Wheel Crank and Pitman (ball bearing) complete, Nos. 46624 and 46630	.....
297C	3826	Band Wheel Crank Screw Centre	.....
46629	—	" " " " " 297C with 1507J	.....
1507J	3826	Band Wheel Crank Screw Centre Nut	.....
972C	3826	" " " " " Set Screw	.....
82887	—	Belt, size ⅜ in., length 68 in., with 25027	.....
25439	6321	" " " " " Guide	.....
1288E	2910	" " " " " Screw	.....
25027	2908	" " " " " Hook	.....
46525	2913	" " " " " Shifter	.....
34D	2909	" " " " " Hinge Screw	.....
25033	2908	" " " " " Spring	.....

STAND

23

NO.	PLATE	NAME	EACH
82896	6321	Brace with three 46629	.....
748E	3826	" " " " " Screw	.....
46526	—	Dress Guard	.....
25049	6321	Dress Guard complete, Nos. 34B, 25033, 46525 and 46526	.....
504E	2909	Dress Guard Bolt with 1510E	.....
1510E	2910	" " " " " Nut	.....
25444	6321	Leg with two each 25068 and 25069	.....
25068	2913	" " " " " Roller	.....
25069	2913	" " " " " Pin	.....
25362	3826	Pitman Ball, size ⅜ in.	per 100
46506	3826	" " " " " Bearing Adjusting Screw Ring	.....
46507	3826	Pitman Ball Bearing Adjusting Screw Ring Locking Washer (brass)	per 100
46508	3826	Pitman Ball Bearing Ring	.....
46509	3826	" " " " " Case	.....
46655	3826	" " " " " Separator	.....
46510	6321	" " " " " Rod with 25360	.....
*25360	—	" " " " " Ball	.....
25371	3826	" " " " " Bushing	.....
25361	3826	" " " " " Screw Bearing	.....
46630	—	" " " " " " 25361 with 1670E	.....
1670E	3826	Pitman Rod Ball Screw Bearing Nut	.....
1520E	3826	" " " " " Lock Nut	.....
25406	6321	Treadle	.....
297C	3826	" " " " " Screw Centre	.....
46629	—	" " " " " 297C with 1507J	.....
1507J	3826	" " " " " Nut	.....
25086	6321	Wrench for 1507, 1510 and 1670	.....
25200	6321	" " " " " 972	.....
82953	—	Stand (iron work) complete, Nos. 504E, 1288E, 25049, 25086, 25200, 25406, 25439, 25442, 46511, 82896, two 25444 and four 748B	.....

**TRIMMINGS FOR CABINET TABLE**

NO.	PLATE	NAME	EACH
87605	6317	Centre Drawer Hinge Bracket with two wood screws ½ in. No. 7	.....
87606	6317	Centre Drawer Hinge Bracket Plate with two wood screws ½ in. No. 7	.....
28243	2917	Centre Drawer Lock with two wood screws ½ in. No. 2	.....

## TRIMMINGS FOR CABINET TABLE

NO.	PLATE	NAME	EACH
28076	2917	Centre Drawer Lock Escutcheon (brass).	
56258	6317	" " Stop Pin.....	
56260	6321	Counterbalance Spring.....	
56261	6321	" " Adjusting Collar	
50251E	2910	" " " "	
		Bolt with 1734E.....	
1734E	2910	Counterbalance Spring Adjusting Collar	
		Bolt Nut.....	
9281	2913	Counterbalance Spring Adjusting Collar	
		Bolt Nut Washer.....	
56262	6321	Counterbalance Spring Bracket (hinge) ..	
28235	2913	Hinge, round ends, for machine platform	
		flap.....	
		NOTE: When ordering No. 28235 state finish.	
28234	712	Hinge, round ends, for top leaf.....	
		NOTE: When ordering No. 28234 state finish.	
28227	—	Knob (brass).....	
28228	—	Knob (brass) complete, Nos. 1272E and	
		28227.....	
28221	2911	Knob (oxidized).....	
28223	—	Knob (oxidized) complete, Nos. 1272E and	
		28221.....	
1272E	2911	Knob Screw.....	
25152	2908	Machine Cushion (felt).....	
15254	—	" Hinge Connection (brass) for	
		15266.....	
15251	2908	Machine Hinge Connection (oxidized) for	
		15264.....	
2809	2908	Machine Hinge Connection Hinge Pin...	
50380C	6317	" " " Set Screw....	
15265	—	" " Plate (brass) for 15266...	
15263	2908	" " " (oxidized) for 15264.	
15266	—	Machine Hinge (brass) complete, Nos.	
		2809, 15254, 15265 and brass wood	
		screw $\frac{7}{8}$ in. No. 10.....	
15264	—	Machine Hinge (oxidized) complete, Nos.	
		2809, 15251, 15263 and oxidized wood	
		screw $\frac{7}{8}$ in. No. 10.....	
56263	6321	Machine Lifting Plate.....	
*56319	—	" " " 56263 with 28123	
		and 56262.....	
28123	2908	Machine Lifting Plate Hinge Pin.....	
56264	6321	Machine Lifting Plate complete, Nos.	
		9281, 50251E, 56260, 56261 and 56319.	
56429	2917	Partition Lock (revolving bolt, double) ..	
56430	2917	" " (revolving bolt, single)....	

## TRIMMINGS FOR CABINET TABLE

NO.	PLATE	NAME	EACH
28076	2917	Partition Lock Escutcheon (brass).....	
28233	2913	" " Key (steel).....	
28125	712	Shield Supporting Bracket.....	
25047	2913	Skeleton Drawer Case Drawer Spring....	
46612	2913	" " " Support with two	
		wood screws $\frac{1}{2}$ in. No. 7 R. H. B.....	

## TRIMMINGS FOR DRAWING-ROOM CABINET

NO.	PLATE	NAME	EACH
28210	2908	Attachment Tray Pull (leather).....	
28211	2908	" " " Washer.....	
28205	2915	Band Wheel with 972c.....	
28005	2915	" " Bracket with 302c and 1507J	
28206	2915	" " Crank.....	
28248	—	Band Wheel Crank and Pitman (ball	
		bearing) complete, Nos. 1520E, 25371,	
		28206, 28247, 46506 to 46509, 46655,	
		56317 and six 25362.....	
302c	2909	Band Wheel Crank Screw Centre.....	
1507J	2910	" " " " Nut....	
972c	3826	" " Set Screw.....	
28007	—	Belt, size $1\frac{1}{8}$ in., length $65\frac{1}{2}$ in., with	
		25027.....	
28011	2915	Belt Guide with 34D, 25033 and 28015...	
28012	2917	" " Screw Eye.....	
28126	2908	" Hole Bushing (oval, brass) $\frac{5}{8}$ in.	
		x 1 in.....	
28250	—	Belt Hole Bushing (oval, oxidized) $\frac{5}{8}$ in.	
		x 1 in.....	
25027	2908	Belt Hook.....	
28015	712	" Shifter.....	
34D	2909	" " Hinge Screw.....	
25033	2908	" " Spring.....	
28016	712	Cabinet Case Roller (iron).....	
28017	712	" " " Frame.....	
28018	2908	" " " Pin.....	
28019	712	Cabinet Case Roller complete, Nos. 28016	
		to 28018.....	
28020	2915	Drawer Lock Bolt.....	
28021	712	" " " Cam and Plate.....	
28076	2917	" " Escutcheon (brass).....	
87363	712	" " Key.....	
15232	2915	Drip Pan.....	

26 TRIMMINGS FOR DRAWING-ROOM CABINET

NO.	PLATE	NAME	EACH
28253	712	Hinge, 1 in. x 1 $\frac{1}{8}$ in., for doors.....	
NOTE: When ordering No. 28253 state finish.			
28234	712	Hinge, round ends, for top leaf.....	
NOTE: When ordering No. 28234 state finish.			
28227	—	Knob (brass).....	
28228	—	Knob (brass) complete, Nos. 1272E and 28227.....	
28221	2911	Knob (oxidized).....	
28223	—	Knob (oxidized) complete, Nos. 1272E and 28221.....	
1272E	2911	Knob Screw.....	
56323	6429	Latch.....	
56324	6429	" Button.....	
56438	6317	" " Hinge Pin.....	
56325	6429	" Frame.....	
28034	2908	" Hinge Pin.....	
28200	2908	" Spring.....	
5604	2908	" " Rivet..... per 100	
56326	6429	Latch complete, Nos. 5604, 28034, 28200, 56323 to 56325 and 56438.....	
8294	2908	Machine Hinge Connection.....	
8295	2908	" " " Hinge Pin....	
50380c	6317	" " " Set Screw....	
87571	6317	" " Head.....	
SS368B	6317	" " " Screw.....	
87572	6317	" " " Washer....	
87573	—	Machine Hinge complete, Nos. SS368B, 8294, 8295, 87571 and 87572.....	
28242	6317	Machine Rest Cushion (leather) with 5604	
5604	2908	" " " Pin..... per 100	
25362	3826	Pitman Ball, size $\frac{3}{8}$ in..... per 100	
46506	3826	" " Bearing Adjusting Screw Ring.....	
46507	3826	Pitman Ball Bearing Adjusting Screw Ring Locking Washer (brass)... per 100	
46508	3826	Pitman Ball Bearing Ring.....	
46509	3826	" " Case.....	
46655	3826	" " Separator.....	
28247	2915	" Rod with 25360.....	
*25360	—	" " Ball.....	
25371	3826	" " " Bushing.....	
56253	2917	" " " Screw Bearing.....	
*56317	—	" " " " 56253 with 1670E.....	
1670E	3826	Pitman Rod Ball Screw Bearing Nut....	
1520E	3826	" " Lock Nut.....	

TRIMMINGS FOR DRAWING-ROOM CABINET 27

NO.	PLATE	NAME	EACH
*56257	—	Rocking Frame.....	
*56255	—	" " 56257 with two each 28043 and 28045.....	
28041	2915	Rocking Frame 56255 with 434c and 28048.....	
28042	2915	Rocking Frame Bracket.....	
28043	2915	" " Connecting Link.....	
28044	712	" " " " Bracket	
2269	2908	" " " " " "	
		Pin.....	
28045	2917	Rocking Frame Connecting Link Hinge Stud.....	
28046	2915	Rocking Frame Hinge Plate.....	
28047	2915	" " Spring.....	
28048	2915	" " " Adjusting Block	
28049	2908	" " " " " "	
		Pin.....	
434c	2909	Rocking Frame Spring Adjusting Block Set Screw.....	
28051	2917	Spring Catch.....	
28052	2917	" " Cup.....	
28208	2915	Treadle.....	
297c	2910	" Screw Centre.....	
56252	2915	" " " Bracket with 297c and 1507J.....	
1507J	2910	Treadle Screw Centre Nut.....	
25086	6321	Wrench for 1507 and 1670.....	
25200	6321	" " 972.....	

TRIMMINGS FOR OPEN-SIDE DRAWING-ROOM CABINET

NO.	PLATE	NAME	EACH
15514	6317	Apron Spring.....	
28277	6317	" " Screw Eye.....	
25442	6321	Band Wheel, 12 $\frac{1}{2}$ in. diam., with 972c....	
46515	6321	" " Crank.....	
28260	—	Band Wheel Crank and Pitman (ball bearing) complete, Nos. 1520E, 25371, 28267, 46506 to 46509, 46515, 46655, 56317 and six 25362.....	
28261	6322	Band Wheel Crank Frame with two each 297c and 1507J.....	
28262	6322	Band Wheel Crank Frame Bracket with 28263.....	

28 TRIMMINGS FOR DRAWING-ROOM CABINET

NO.	PLATE	NAME	EACH
28263	6317	Band Wheel Crank Frame Bracket	
		Cushion (leather)	
649E	2909	Band Wheel Crank Frame Screw	
297C	3826	" " " " " Nut	
1507J	3826	" " " " " Nut	
972C	3826	" " Set Screw	
25135	—	Belt, size $\frac{3}{8}$ in., length 67 $\frac{1}{2}$ in., with 25027	
28266	2912	Belt Guide	
25027	2908	" Hook	
46525	2913	" Shifter	
34D	2909	" " Hinge Screw	
25033	2908	" " Spring	
28016	712	Cabinet Case Roller (iron)	
28017	712	" " " Frame	
28018	2908	" " " Pin	
28019	712	Cabinet Case Roller complete, Nos. 28016 to 28018	
56260	6321	Counterbalance Spring	
56261	6321	" " Adjusting Collar	
50251E	2910	" " " " "	
		Bolt with 1734E	
1734E	2910	Counterbalance Spring Adjusting Collar Bolt Nut	
9281	2913	Counterbalance Spring Adjusting Collar Bolt Nut Washer	
56262	6321	Counterbalance Spring Bracket (hinge)	
28278	—	Door Drawer Lock Plate (brass)	
28279	4270	" " " " (oxidized)	
28280	—	" " " " H u b K e y (brass)	
28281	4270	Door Drawer Lock Plate Hub Key (oxidized)	
28283	4270	Door Hinge	
		NOTE: When ordering No. 28283 state finish.	
28284	—	Door Lock (brass) with four round head brass wood screws $\frac{3}{4}$ in. No. 4	
28285	4270	Door Lock (oxidized) with four round head oxidized wood screws $\frac{3}{4}$ in. No. 4	
28286	—	Door Lock Key (brass)	
28287	4270	" " " (oxidized)	
28288	—	" " " Hole Escutcheon (brass) with two round head brass wood screws $\frac{3}{8}$ in. No. 2	
28289	4270	Door Lock Key Hole Escutcheon (oxidized) with two round head oxidized wood screws $\frac{3}{8}$ in. No. 2	

TRIMMINGS FOR DRAWING-ROOM CABINET 29

NO.	PLATE	NAME	EACH
56254	4270	Door Lock Plate	
46526	—	Dress Guard	
25049	6321	Dress Guard complete, Nos. 34D, 25033, 46525 and 46526	
1059E	2910	Dress Guard Bolt with 1510E	
1510E	2910	" " " Nut	
28235	712	Hinge, round end, for machine platform flap	
		NOTE: When ordering No. 28235 state finish.	
28234	712	Hinge, round ends, for top leaf	
		NOTE: When ordering No. 28234 state finish.	
25152	2908	Machine Cushion (felt)	
15254	—	" Hinge Connection (brass) for 15266	
15251	2908	Machine Hinge Connection (oxidized) for 15264	
2809	2908	Machine Hinge Connection Hinge Pin	
50380c	6317	" " " Set Screw	
15265	—	" " Plate (brass) for 15266	
15263	2908	" " " (oxidized) for 15264	
15266	—	Machine Hinge (brass) complete, Nos. 2809, 15254, 15265 and brass wood screw $\frac{7}{8}$ in. No. 10	
15264	—	Machine Hinge (oxidized) complete, Nos. 2809, 15251, 15263 and oxidized wood screw $\frac{7}{8}$ in. No. 10	
56263	6321	Machine Lifting Plate	
*56319	—	" " " 56263 with 28123 and 56262	
28123	2908	Machine Lifting Plate Hinge Pin	
56264	6321	Machine Lifting Plate complete, Nos. 9281, 50251E, 56260, 56261 and 56319	
25362	3826	Pitman Ball, size $\frac{3}{8}$ in. per 100	
46506	3826	" " Bearing Adjusting Screw Ring	
46507	3826	Pitman Ball Bearing Adjusting Screw Ring Locking Washer (brass) per 100	
46508	3826	Pitman Ball Bearing Ring	
46509	3826	" " Case	
46655	3826	" " Separator	
28267	6322	" Rod with 25360	
*25360	—	" " Ball	
25371	3826	" " " Bushing	
56253	2917	" " " Screw Bearing	
56317	—	" " " " 56253 with 1670E	

30 TRIMMINGS FOR DRAWING-ROOM CABINET

NO.	PLATE	NAME	EACH
1670E	3826	Pitman Rod Ball Screw Bearing Nut.....	
1520E	3826	" " Lock Nut.....	
28290	4270	Top Leaf Support Cushion (rubber).....	
25406	6321	Treadle.....	
28268	4270	" Centre.....	
28269	2912	" " Bracket with 28268.....	
297c	3826	" Screw Centre.....	
1507j	3826	" " " Nut.....	
25086	6321	Wrench for 1507, 1510 and 1670.....	
25200	6321	" " 972.....	

TRIMMINGS FOR PORTABLE CASE

NO.	PLATE	NAME	EACH
25070	2908	Base Cushion Tack (rubber).....	
87581	6413	" Lid Catch Plate with wood screws 3/8 in. No. 3 R. H. (nickel) and 1/4 in. No. 3 R. H. (nickel).....	
87582	6413	Base Lid Catch Plate Pin.....	
87428	6413	Cover Hook.....	
87431	6413	" " Plate.....	
56251	6316	" Lock.....	
28077	6316	" " Escutcheon (nickel).....	
28233	712	" " Key (steel).....	
87427	6413	" " Plate.....	
87555	2930	" Reinforcing Plate.....	
15214	1962	Drip Pan.....	
28088	6413	Handle (wood).....	
50289B	6413	" Bolt.....	
NN83J	6413	" " Nut.....	
28229	6413	" Hinge Rivet.....	
87558	6413	" Link.....	
28231	6413	" Stud.....	
87550	—	Handle complete, Nos. 28088, 28231, 87555, two each NN83J, 28229, 50289B and 87558.....	
87342	6413	Machine Button with 84151 and wood screw 1 in. No. 9 R. H. B.....	
84151	6413	Machine Button Washer (leather).....	
8294	2908	" Hinge Connection.....	
8295	2908	" " " Hinge Pin....	
50380c	6317	" " " Set Screw....	
87571	6317	" " " Head.....	
SS368B	6317	" " " Screw.....	
87572	6317	" " " " Washer.....	

TRIMMINGS FOR PORTABLE CASE

31

NO.	PLATE	NAME	EACH
87573	—	Machine Hinge complete, Nos. SS368B, 8294, 8295, 87571 and 87572.....	
28242	6413	Machine Rest Cushion (leather) with 5604.....	
5604	6413	Machine Rest Cushion Pin..... per 100	

OBSOLETE PARTS

NO.	PLATE	NAME	EACH
*32501	—	Arm.....	
32502	2901	" Shaft.....	
32577	2920	" ".....	
32615	2920	" ".....	
32561	—	" Side Cover, use 32633.....	
2008	2919	Balance Wheel, 2 1/2 in. pulley, for 32556 for Drawing Room Cabinet.....	
2804	2900	Balance Wheel, 3 in. pulley, for 32556 for Cabinet Table.....	
32584	2919	Balance Wheel (light rim) 2 1/2 in. pulley, for 32556 for Drawing Room Cabinet..	
32588	2922	Balance Wheel (light rim) 3 in. pulley, for 32556 for Cabinet Table.....	
15283	6313	Bobbin Winder Adjusting Arm for 32608.	
15293	6313	" " Thread Guide Spring...	
32606	6314	" " Stop Latch for 50060B...	
50060B	6313	" " " Hinge Screw.	
32607	6314	" " Thread Guide for 15293..	
2749	6313	" " Worm Wheel Friction Washer for 32629.....	
32555	2900	Clamp Stop Motion Flanged Bushing for 32556.....	
32556	—	Clamp Stop Motion complete, Nos. 248A, 256B, 1148c, 2020 and 32555.....	
28116	6321	Counterbalance Spring (Trimmings for Cabinet Table).....	
28202	6321	Counterbalance Spring Adjusting Collar (Trimmings for Cabinet Table).....	
28299	2911	Counterbalance Spring Adjusting Pin (Trimmings for Cabinet Table).....	
28300	6321	Counterbalance Spring Bracket (Trim- mings for Cabinet Table).....	
28218	6321	Counterbalance Spring Bracket (hinge) for 28220.....	
28198	6321	Counterbalance Spring Support Pin, wood (Trimmings for Cabinet Table).....	

## OBSOLETE PARTS

NO.	PLATE	NAME	EACH
32563	—	Drip Pan for Drawing Room Cabinet, use 15232.....	
2827	2902	Face Plate Thread Guard with 8505, for 32506.....	
32582	2921	Feed Cover Plate with 1423B and 32583, for art work.....	
32583	2921	Feed Cover Plate Position Stud.....	
1423B	2921	" " " Screw.....	
32508	2903	" Dog.....	
32509	2901	" Forked Connection with 175B, use 32620.....	
27C	2909	Feed Forked Connection Hinge Screw.....	
32511	2901	" Rock Shaft.....	
32512	—	" " " 32511 with 32551.....	
32554	2902	" " " Crank with 157B.....	
157B	2902	" " " Clamping Screw.....	
28029	712	Latch.....	
28030	712	" Button (brass).....	
28032	2908	" " Hinge Pin.....	
28033	712	" Frame.....	
28037	712	Latch (brass) complete, Nos. 5604, 28029, 28030, 28032 to 28034 and 28200 (Trim-mings for Drawing Room Cabinet)....	
28219	6321	Machine Lifting Plate for 28220.....	
28220	6321	" " " 28219 with 28123 and 28218 (Trim-mings for Cabinet Table).....	
1012E	2910	Needle Bar Connecting Link Adjusting Screw.....	
32516	2904	Needle Bar Connecting Stud with 399F.....	
399F	2904	" " " " Clamping Screw.....	
21305	2904	Needle Bar Hole Plug, use 21360.....	
28880	5635	" Case for 35920.....	
32523	2911	Oscillating Hook Bobbin Case with 591F and 32534, use 32566.....	
32566	2905	Oscillating Hook Bobbin Case with 1172E, 1173D and 32567.....	
32524	2905	Oscillating Hook Bobbin Case Position Bracket, use 32591.....	
32525	—	Oscillating Hook Bobbin Case Position Bracket complete, Nos. 662D, 1137E, 32526 to 32528 and 32591.....	
32526	2905	Oscillating Hook Bobbin Case Thread Guard.....	
662D	2905	Oscillating Hook Bobbin Case Thread Guard Screw.....	

## OBSOLETE PARTS

NO.	PLATE	NAME	EACH
32530	2906	Oscillating Hook Crank with 971B, use 32594.....	
971B	2906	Oscillating Hook Crank Clamping Screw.....	
32532	2901	" " Slide for 32533.....	
32533	2911	" " " Friction Spring for 32532.....	
591F	2911	Oscillating Hook Tension Regulating Screw.....	
32534	2911	Oscillating Hook Tension Spring for 32523.....	
32565	—	Presser Bar Spring, use 3100.....	
32559	2903	Presser Foot.....	
32537	2906	Slack Thread Regulator for 32546.....	
32579	2921	" " " " 32576, use 32621.....	
32012	2906	Tension Disc.....	
32538	2906	" Releaser.....	
32539	2906	" Releasing Lever.....	
26076	2906	Thread Cutter, use 26075.....	
2106	2906	" Guard (head of arm).....	
32540	2904	" Take-up Crank.....	
32545	2906	" " Spring.....	
32546	2906	" " " Regulator.....	
32547	2903	Throat Plate for 32508.....	
32571	2903	" " " " .....	



**NUMERICAL LIST OF PARTS**

**FOR**

**MACHINES**

**Nos. 66-1 and 66-3**

## NUMERICAL LIST OF PARTS

NO. PLATE	NAME	EACH
27c 2909	Feed Forked Connection Hinge Screw, obsolete.....	
34b 2909	Belt Shifter Hinge Screw for 25049 and 28011.....	
42e 2902	Feed Regulator Hinge Screw.....	
44k 2909	Oscillating Hook Pitman Screw Stud (left)	
48b 2907	Bobbin Winder Frame Hinge Screw for 32553, 32587 and 32603, obsolete.....	
50b 2907	Bobbin Winder Worm Wheel Screw Stud for 32553 and 32587, obsolete.....	
50b 6313	Bobbin Winder Worm Wheel Screw Stud (eccentric) for 32603 and 32608, obsolete	
50b 6313	Bobbin Winder Worm Wheel and Thread Guide Cam Screw Stud (eccentric) for 32629.....	
NN83j 6413	Handle Bolt Nut for 87550.....	
85e 2906	Presser Bar Lifter Screw.....	
92b 2907	Bobbin Winder Stop Latch Hinge Screw for 32553, 32587 and 32603, obsolete...	
92b 2907	Bobbin Winder Thread Guide Hinge Screw for 32553, 32587 and 32603, obsolete...	
97e 2906	Tension Releasing Lever Hinge Screw...	
107b 2909	Face Plate Screw.....	
122e 2909	Arm Rock Shaft Adjusting Screw for 8203	
134b 2910	Bobbin Winder Bracket Screw for 32603, obsolete.....	
137b 4916	Hand Attachment Screw for 33616 and 94001b.....	
142b 2905	Oscillating Hook Bobbin Case Position Bracket Screw.....	
145b 2910	Hand Attachment Body Bracket Cap Screw for 32609, obsolete.....	
157b 2902	Feed Rock Shaft Crank Clamping Screw for 32554, obsolete.....	
171A 2929	Tuck Folder Adjusting Screw for 36091...	
175b 2909	Feed Forked Connection Adjusting Screw for 32509 and 32620.....	
175j 2909	Oscillating Hook Pitman Adjusting Screw for 32531.....	
180b 6313	Bobbin Winder Bracket Screw for 32553, 32587, 32608 and 32629.....	
183e 4916	Hand Attachment Body Bracket Screw for 32603, 33616 and 94001b.....	

## NUMERICAL LIST OF PARTS

NO. PLATE	NAME	EACH
1130E 2904	Needle Bar Connecting Link Cap Screw.	
1131c 2904	Thread Take-up Lever Link Hinge Screw	
1132K 2905	Oscillating Hook Connecting Link Hinge Screw.....	
1133E 2904	Needle Bar Bushing Set Screw.....	
1134c 2904	" " Crank Position Screw for 32517.....	
1135J 2905	Oscillating Hook Bell Crank Stud.....	
1136B 2909	Face Plate Thumb Screw.....	
1137E 2905	Oscillating Hook Bobbin Ejector Hinge Screw for 32525 and 32592.....	
1148c 2909	Clamp Stop Motion Flanged Bushing Set Screw for 32556 and 32619.....	
1155B 2906	Presser Foot Holder Screw.....	
1158B 2906	" " Thumb Screw.....	
1172F 2905	Oscillating Hook Bobbin Case Tension Regulating Screw for 32566 and 32590.	
1173D 2905	Oscillating Hook Bobbin Case Tension Spring Screw for 32566 and 32590.....	
1216c 2909	Oscillating Hook Pitman Screw Stud (right).....	
1259c 2904	Needle Bar Crank Set Screw for 32517....	
1272E 2911	Knob Screw for 28223 and 28228.....	
1274E 2906	Tension Screw Stud for 32654.....	
1285c 2902	Feed Cam Set Screw for 32562.....	
1288E 2910	Belt Guide Screw for 82953.....	
1301K 2902	Feed Raising Bar Hinge Screw.....	
1353c 2911	Needle Bar Connecting Stud Set Screw for 32580.....	
1381K 2910	Feed Forked Connection Hinge Screw (eccentric).....	
1422B 936	Embroidery Attachment Spool Bracket Tension Regulating Thumb Screw for 35504.....	
1423B 2921	Feed Cover Plate Screw for 32582, obsolete	
1483H 2929	Tuck Folder Thumb Screw for 36091....	
1485J 2911	Oscillating Hook Crank Clamping Screw for 32594.....	
1507J 3826	Band Wheel Crank Screw Centre Nut for 28005, 28261 and 46629.....	
1507J 3826	Treadle Screw Centre Nut for 28261, 46629 and 56252.....	
1508J 2910	Arm Rock Shaft Screw Centre (lower) Nut.....	
1510E 2910	Dress Guard Bolt Nut for 501E and 1059E	
1513J 2910	Feed Rock Shaft Screw Centre Nut for 56814.....	

## NUMERICAL LIST OF PARTS

NO. PLATE	NAME	EACH
1519J 2902	Feed Bar Screw Centre Nut.....	
1520J 2910	" Forked Connection Hinge Screw Nut.....	
1520J 2910	Oscillating Hook Pitman Screw Stud (right) Nut.....	
1520E 3826	Pitman Rod Lock Nut for 28248, 28260 and 46624.....	
1528H 6313	Bobbin Winder Worm Wheel Screw Stud Nut for 32553, 32587, 32603 and 32608, obsolete.....	
1528H 6313	Bobbin Winder Worm Wheel and Thread Guide Cam Screw Stud Nut for 32629..	
1560B 2906	Tension Regulating Thumb Nut for 32654	
1642J 2905	Oscillating Hook Bell Crank Stud Collar with 465c.....	
1670E 3826	Pitman Rod Ball Screw Bearing Nut for 46630 and 56317.....	
1704B 2929	Tuck Folder Screw Stud Thumb Nut for 36091.....	
1705B 2929	Tuck Folder Space Gauge Screw Stud Thumb Nut for 36091.....	
1734E 2910	Counterbalance Spring Adjusting Collar Bolt Nut for 50251E.....	
1832 2909	Feed Forked Connection Roller with 1085E.....	
1944 2902	Feed Bar Roller and Stud for 32507.....	
1944 2902	" Raising Bar Roller and Stud for 32510.....	
2002 2902	Arm Dowel Pin.....	
2007 2902	" Spool Pin.....	
2008 2919	Balance Wheel, 2½ in. pulley, for 32556, for Drawing Room Cabinet, obsolete..	
2020 2900	Clamp Stop Motion Clamp Washer for 32556 and 32619.....	
2054 2904	Needle Clamp with 552c.....	
2070 2906	Presser Bar Spring Washer.....	
2102 2921	Tension Disc for 32654.....	
2106 2906	Thread Guard (head of arm) obsolete....	
2269 2908	Rocking Frame Connecting Link Bracket Pin (Trimings for Drawing Room Cabinet).....	
2442 2907	Bobbin Winder Stop Latch Spring for 32553 and 32587, obsolete.....	
2460 2916	Bobbin Winder Friction Ring (rubber) for 32603, obsolete.....	
2461 2916	Bobbin Winder Pulley for 32603, obsolete	

## NUMERICAL LIST OF PARTS

NO.	PLATE	NAME	EACH
2532	6310	Hand Attachment Pinion Dowel Pin for 32603 and 33646, obsolete.....	per 100
2746	6313	Bobbin Winder Thread Guide Cam for 15403, obsolete.....	
2747	2907	Bobbin Winder Stop Latch Spring for 32603, obsolete.....	
2747	2907	Bobbin Winder Thread Guide Spring for 32553, 32587 and 32603, obsolete.....	
2748	6313	Bobbin Winder Worm Wheel for 15403, obsolete.....	
2749	6313	Bobbin Winder Worm Wheel Friction Washer for 32553, 32587, 32603 and 32608, obsolete.....	
2804	2900	Balance Wheel, 3 in. pulley, for 32556, for Cabinet Table, obsolete.....	
2809	2908	Machine Hinge Connection Hinge Pin for 15264 and 15266.....	
2827	2902	Face Plate Thread Guard with 8505, for 32506, obsolete.....	
3100	2900	Presser Bar Spring.....	
4604	934	Corder Bow Rivet for 35114.....	per 100
4604	934	Embroidery Attachment Body Block Rivet for 35853.....	per 100
5604	2908	Latch Spring Rivet for 28037 and 56326, .....	per 100
5604	2908	Machine Rest Cushion Pin for 28242, .....	per 100
8203	2901	Arm Rock Shaft with 122E.....	
8204	2902	" " " Centre (upper).....	
8216	2902	Feed Regulator.....	
8217	2902	" " Friction Washer.....	
8238	2906	Tension Spring for 32654.....	
8280	4916	Hand Attachment Crank Hinge Pin for 32603, 33646 and 94001B.....	
8281	4916	Hand Attachment Crank Lock Pin for 8392 and 94010.....	
8282	4916	Hand Attachment Crank Lock Pin Spring for 8392 and 94010.....	
Nos. 8284 to 8286 FOR 32603, OBSOLETE.			
8284	2916	Hand Attachment Driver Finger.....	
8285	2916	" " " " Hinge Pin.....	
8286	2916	Hand Attachment Driver Finger Lock Spring.....	
8294	2908	Machine Hinge Connection for 87573.....	

## NUMERICAL LIST OF PARTS

NO.	PLATE	NAME	EACH
8295	2908	Machine Hinge Connection Hinge Pin for 87573.....	
8312	—	Hand Attachment Body Bracket Cap (belt cover) for 32609, obsolete.....	
8313	2916	Hand Attachment Driver for 32603, obsolete.....	
8377	6309	Hand Attachment Body for 32603 and 33646, obsolete.....	
8380	6309	Hand Attachment Crank Handle (wood) for 8436 and 15296, obsolete.....	
8382	6310	Hand Attachment Crank Handle Spindle Washer for 8434, obsolete.....	
8386	6310	Hand Attachment Driver Finger Hinge Pin for 33646, obsolete.....	
8387	6310	Hand Attachment Driver Finger Lock Pin for 33646, obsolete.....	
8388	4916	Hand Attachment Driver Finger Lock Pin Spring for 33646 and 94001B.....	
8390	4916	Hand Attachment Driver Finger Sheath Plate for 94007B.....	
8391	4916	Hand Attachment Driver Finger Sheath Staple for 94007B.....	
Nos. 8392 to 8394 FOR 32603 AND 33646, OBSOLETE.			
8392	6309	Hand Attachment Gear with 8281 and 8282.....	
8393	6309	Hand Attachment Gear Cover.....	
8394	6310	" " Pinion.....	
8422	2921	Thread Guard (head of arm).....	
8433	—	Hand Attachment Crank Handle Spindle for 8434, obsolete.....	
8434	6309	Hand Attachment Crank Handle Spindle 8433 with 8382, for 8436 and 15296, obsolete.....	
8435B	4915	Hand Attachment Crank Lever for 8436 and 94005B.....	
8436	—	Hand Attachment Crank complete for 33646, Nos. 8380, 8434 and 8435B, obsolete.....	
8505	2902	Face Plate Thread Guard Rivet for 2827 and 32630.....	per 100
8879	2913	Arm Spool Pin Washer (cloth).....	
9281	2913	Counterbalance Spring Adjusting Collar Bolt Nut Washer for 56264.....	
9859	1018	Embroidery Attachment Thread Bracket Rivet for 26536.....	per 100
12329	2906	Tension Releasing Lever Spring.....	

NO.	PLATE	NAME	EACH
15072	6313	Bobbin Winder Bobbin Position Pin for 32550 and 32612.....per 100	
15214	1962	Drip Pan (Trimings for Portable Case).	
15232	2915	" " (Trimings for Drawing Room Cabinet).....	
15251	2908	Machine Hinge Connection (oxidized) for 15264.....	
15254	—	Machine Hinge Connection (brass) for 15266.....	
15263	2908	Machine Hinge Plate (oxidized) for 15264	
15264	—	Machine Hinge (oxidized) complete, Nos. 2809, 15251, 15263 and oxidized wood screw $\frac{7}{8}$ in. No. 10 (Trimings for Cabinet Table and Open Side Drawing Room Cabinet).....	
15265	—	Machine Hinge Plate (brass) for 15266....	
15266	—	Machine Hinge (brass) complete, Nos. 2809, 15254, 15265 and brass wood screw $\frac{7}{8}$ in. No. 10 (Trimings for Cabinet Table and Open Side Drawing Room Cabinet).....	
15282	2922	Balance Wheel, 2 $\frac{1}{2}$ in. pulley.....	
15283	6313	Bobbin Winder Adjusting Arm for 32608, obsolete.....	
15285	6313	Bobbin Winder Frame for 32608, obsolete	
15286	6313	" " " Spring for 32608 and 32629.....	
15287	6313	Bobbin Winder Friction Ring (rubber) for 32608 and 32629.....	
15288	6313	Bobbin Winder Pulley for 32608, obsolete	
15291	6313	" " Stop Latch Spring for 32608 and 32629.....	
15293	6313	Bobbin Winder Thread Guide Spring, obsolete.....	
15295	2912	Hand Attachment Crank Lever for 15296, obsolete.....	
15296	—	Hand Attachment Crank complete for 32603, Nos. 8380, 8434 and 15295, obsolete.....	
15366	6313	Bobbin Winder Thread Guide Spring for 32608 and 32629.....	
15376	6314	Bobbin Winder Adjusting Arm for 32608 and 32629.....	
15403	—	Bobbin Winder Worm Wheel 2748 with 233B and 2746, for 32553, 32587, 32603 and 32608, obsolete.....	

NO.	PLATE	NAME	EACH
15413	6314	Bobbin Winder Frame for 32629.....	
15414	6314	" " Pulley for 32629.....	
15416	6314	" " Worm Wheel and Thread Guide Cam for 32629.....	
15424	6314	Bobbin Winder Worm Wheel and Thread Guide Cam Friction Washer for 32629.....	
15514	6317	Apron Spring (Trimings for Open Side Drawing Room Cabinet).....	
19044	2929	Tuck Folder Screw Stud Cap Screw Spring Washer for 36091.....	
21305	2904	Needle Bar Hole Plug, obsolete, use 21360	
21360	2921	Needle Bar Hole Plug.....	
22232	1018	Embroidery Attachment Driving Lever Friction Washer for 35051.....	
22232	1018	Embroidery Attachment Scroll Carrier Friction Washer for 35051.....	
25027	2908	Belt Hook for 25135, 28007 and 82887...	
25033	2908	" Shifter Spring for 25049 and 28011...	
25047	2913	Skeleton Drawer Case Drawer Spring (Trimings for Cabinet Table).....	
25049	6321	Dress Guard complete, Nos. 34b, 25033, 46525 and 46526 (Stand No. 82953 and Trimings for Open Side Drawing Room Cabinet).....	
25068	2913	Leg Roller for 25444.....	
25069	2913	" " Pin for 25444.....	
25070	2908	Base Cushion Tack, rubber (Trimings for Portable Case).....	
25086	6321	Wrench for 1507, 1510 and 1670.....	
25135	—	Belt, size $\frac{3}{16}$ in., length 67 $\frac{1}{2}$ in., with 25027 (Trimings for Open Side Drawing Room Cabinet).....	
25152	2908	Machine Cushion, felt (Trimings for Cabinet Table and Open Side Drawing Room Cabinet).....	
25200	6321	Wrench for 972.....	
*25360	—	Pitman Rod Ball for 28247, 28267 and 46510.....	
25361	3826	Pitman Rod Ball Screw Bearing for 46630.....	
25362	3826	Pitman Ball, size $\frac{3}{16}$ in., for 28248, 28260 and 46624.....per 100	
25371	3826	Pitman Rod Ball Bushing for 28248, 28260 and 46624.....	
25406	6321	Treadle (Stand No. 82953 and Trimings for Open Side Drawing Room Cabinet).....	

NO.	PLATE	NAME	EACH
25439	6321	Belt Guide for 82953.....	
25442	6321	Band Wheel, 12½ in. diam., with 972c (Stand No. 82953 and Trimmings for Open Side Drawing Room Cabinet)....	
25444	6321	Leg with two each 25068 and 25069, for 82953.....	
25525	5635	Bias Gauge for 35920.....	
25527B	5635	Cloth Guide for 35920.....	
25537	5635	Screw Driver (machine) for 35920.....	
25538	5635	“ “ (bobbin case) for 35920.....	
25539	5635	Stiletto for 35920 and 35987.....	
25789	2918	Corder Bow Tip for 35114.....	
26075	2921	Thread Cutter.....	
26076	2906	“ “ obsolete, use 26075.....	
26521	1018	Embroidery Attachment Driving Lever with 26536, for 35051.....	
26523	1018	Embroidery Attachment Driving Lever Washer for 35051.....	
Nos. 26528 to 26530 FOR 35051.			
26528	1018	Embroidery Attachment Scroll with 468c	
26529	1018	“ “ “ Carrier with 26531.....	
26530	1018	Embroidery Attachment Scroll Carrier Hinge Stud.....	
26531	1018	Embroidery Attachment Scroll Carrier Pin for 26529.....	
26533	1018	Embroidery Attachment Scroll Driving Lever with 26534, for 35051.....	
26534	1018	Embroidery Attachment Scroll Driving Lever Stud for 26533.....	
26535	1017	Embroidery Attachment Spool Pin, for arm of machine, for 35051.....	
26536	1018	Embroidery Attachment Thread Bracket for 26521.....	
26537	1018	Embroidery Attachment Thread Eyelet for 35051.....	
26784	1018	Embroidery Attachment Driving Lever Hinge Stud for 35051.....	
26785	1018	Embroidery Attachment Thread Retain- ing Spring for 35051.....	
28005	2915	Band Wheel Bracket with 302c and 1507r (Trimmings for Drawing Room Cabinet).....	
28007	—	Belt, size ⅜ in., length 65½ in., with 25027 (Trimmings for Drawing Room Cabinet).....	

NO.	PLATE	NAME	EACH
28011	2915	Belt Guide with 34D, 25033 and 28015 (Trimmings for Drawing Room Cabinet).....	
28012	2917	Belt Guide Screw Eye (Trimmings for Drawing Room Cabinet).....	
28015	712	Belt Shifter for 28011.....	
Nos. 28016 to 28018 FOR 28019.			
28016	712	Cabinet Case Roller (iron).....	
28017	712	“ “ “ Frame.....	
28018	2908	“ “ “ Pin.....	
28019	712	Cabinet Case Roller complete, Nos. 28016 to 28018 (Trimmings for Drawing Room Cabinet and Open Side Drawing Room Cabinet).....	
28020	2915	Drawer Lock Bolt (Trimmings for Draw- ing Room Cabinet).....	
28021	712	Drawer Lock Bolt Cam and Plate (Trim- mings for Drawing Room Cabinet)....	
28029	712	Latch for 28037, obsolete.....	
28030	712	“ Button (brass) for 28037, obsolete.	
28032	2908	“ “ Hinge Pin for 28037, obso- lete.....	
28033	712	Latch Frame for 28037, obsolete.....	
28034	2908	“ Hinge Pin for 28037 and 56326....	
28037	712	Latch (brass) complete, Nos. 5604, 28029, 28030, 28032 to 28034 and 28200 (Trimmings for Drawing Room Cabinet) obsolete.....	
Nos. 28041 to 28049 (TRIMMINGS FOR DRAWING ROOM CABINET)			
28041	2915	Rocking Frame 56255 with 434c and 28048.....	
28042	2915	Rocking Frame Bracket.....	
28043	2915	“ “ Connecting Link for 56255.....	
28044	712	Rocking Frame Connecting Link Bracket	
28045	2917	“ “ “ “ Hinge Stud for 56255.....	
28046	2915	Rocking Frame Hinge Plate.....	
28047	2915	“ “ Spring.....	
28048	2915	“ “ “ Adjusting Block for 28041.....	
28049	2908	Rocking Frame Spring Adjusting Block Pin.....	

## NUMERICAL LIST OF PARTS

NO.	PLATE	NAME	EACH
28051	2917	Spring Catch (Trimings for Drawing Room Cabinet).....	
28052	2917	Spring Catch Cup (Trimings for Drawing Room Cabinet).....	
28076	2917	Centre Drawer Lock Escutcheon, brass (Trimings for Cabinet Table).....	
28076	2917	Drawer Lock Escutcheon, brass (Trimings for Drawing Room Cabinet).....	
28076	2917	Partition Lock Escutcheon, brass (Trimings for Cabinet Table).....	
28077	6316	Cover Lock Escutcheon, nickeled (Trimings for Portable Case).....	
28088	6413	Handle (wood) for 87550.....	
28116	6321	Counterbalance Spring (Trimings for Cabinet Table) obsolete.....	
28123	2908	Machine Lifting Plate Hinge Pin for 28220 and 56319.....	
28125	712	Shield Supporting Bracket (Trimings for Cabinet Table).....	
28126	2908	Belt Hole Bushing (oval, brass) $\frac{5}{8}$ in. x 1 in. (Trimings for Drawing Room Cabinet).....	
28198	6321	Counterbalance Spring Support Pin, wood (Trimings for Cabinet Table) obsolete.....	
28200	2908	Latch Spring for 28037 and 56326.....	
28202	6321	Counterbalance Spring Adjusting Collar (Trimings for Cabinet Table) obsolete.....	
28205	2915	Band Wheel with 972c (Trimings for Drawing Room Cabinet).....	
28206	2915	Band Wheel Crank for 28248.....	
28208	2915	Treadle (Trimings for Drawing Room Cabinet).....	
28210	2908	Attachment Tray Pull, leather (Trimings for Drawing Room Cabinet).....	
28211	2908	Attachment Tray Pull Washer (Trimings for Drawing Room Cabinet).....	
28218	6321	Counterbalance Spring Bracket (hinge) for 28220, obsolete.....	
28219	6321	Machine Lifting Plate for 28220, obsolete.....	
28220	6321	" " " 28219 with 28123 and 28218 (Trimings for Cabinet Table) obsolete.....	
28221	2911	Knob (oxidized) for 28223.....	
28223	—	Knob (oxidized) complete, Nos. 1272E and 28221 (Trimings for Cabinet Table and Drawing Room Cabinet).....	
28227	—	Knob (brass) for 28228.....	

## NUMERICAL LIST OF PARTS

NO.	PLATE	NAME	EACH
28228	—	Knob (brass) complete, Nos. 1272E and 28227 (Trimings for Cabinet Table and Drawing Room Cabinet).....	
28229	6413	Handle Hinge Rivet for 87550.....	
28231	6413	" Stud for 87550.....	
28233	712	Cover Lock Key, steel (Trimings for Portable Case).....	
28233	2913	Partition Lock Key, steel (Trimings for Cabinet Table).....	
28234	712	Hinge, round ends, for top leaf (Trimings for Cabinet Table, Drawing Room Cabinet and Open Side Drawing Room Cabinet).....	
28235	2913	Hinge, round end, for machine platform flap (Trimings for Cabinet Table and Open Side Drawing Room Cabinet).....	
28242	6317	Machine Rest Cushion (leather) with 5604 (Trimings for Drawing Room Cabinet and Portable Case).....	
28243	2917	Centre Drawer Lock with two wood screws $\frac{1}{2}$ in. No. 2 (Trimings for Cabinet Table).....	
28247	2915	Pitman Rod with 25360, for 28248.....	
28248	—	Band Wheel Crank and Pitman (ball bearing) complete, Nos. 1520E, 25371, 28206, 28247, 46506 to 46509, 46655, 56317 and six 25362 (Trimings for Drawing Room Cabinet).....	
28250	—	Belt Hole Bushing (oval, oxidized) $\frac{5}{8}$ in. x 1 in. (Trimings for Drawing Room Cabinet).....	
28253	712	Hinge, 1 in. x $1\frac{3}{8}$ in., for doors (Trimings for Drawing Room Cabinet).....	
Nos. 28260 to 28263 (TRIMINGS FOR OPEN SIDE DRAWING ROOM CABINET).			
28260	—	Band Wheel Crank and Pitman (ball bearing) complete, Nos. 1520E, 25371, 28267, 46506 to 46509, 46515, 46655, 56317 and six 25362.....	
28261	6322	Band Wheel Crank Frame with two each 297c and 1507J.....	
28262	6322	Band Wheel Crank Frame Bracket with 28263.....	
28263	6317	Band Wheel Crank Frame Bracket (Cushion (leather) for 28262).....	

## NUMERICAL LIST OF PARTS

NO.	PLATE	NAME	EACH
Nos. 28266 TO 28269 (TRIMMINGS FOR OPEN SIDE DRAWING ROOM CABINET).			
28266	2912	Belt Guide.....	
28267	6322	Pitman Rod with 25360, for 28260.....	
28268	4270	Treadle Centre for 28269.....	
28269	2912	" " Bracket with 28268.....	
Nos. 28277 TO 28281 (TRIMMINGS FOR OPEN SIDE DRAWING ROOM CABINET).			
28277	6317	Apron Spring Screw Eye.....	
28278	—	Door Drawer Lock Plate (brass).....	
28279	4270	" " " " (oxidized).....	
28280	—	" " " " H u b K e y (brass).....	
28281	4270	Door Drawer Lock Plate Hub Key (oxidized).....	
(Nos. 28283 TO 28290 (TRIMMINGS FOR OPEN SIDE DRAWING ROOM CABINET).			
28283	4270	Door Hinge.....	
28284	—	" Lock (brass) with four round head brass wood screws $\frac{3}{4}$ in. No. 4.....	
28285	4270	Door Lock (oxidized) with four round head oxidized wood screws $\frac{3}{4}$ in. No. 4.....	
28286	—	Door Lock Key (brass).....	
28287	4270	" " " (oxidized).....	
28288	—	" " " Hole Escutcheon (brass) with two round head brass wood screws $\frac{3}{8}$ in. No. 2.....	
28289	4270	Door Lock Key Hole Escutcheon (oxidized) with two round head oxidized wood screws $\frac{3}{8}$ in. No. 2.....	
28290	4270	Top Leaf Support Cushion (rubber).....	
28299	2911	Counterbalance Spring Adjusting Pin (Trimblings for Cabinet Table) obsolete.....	
28300	6321	Counterbalance Spring Bracket (Trimblings for Cabinet Table) obsolete.....	
28789	2903	Hemmer (foot) for $\frac{1}{8}$ in. hem.....	
28880	5635	Needle Case for 35920, obsolete.....	
28986	2903	Hemstitcher.....	
28996	—	Hemmer (foot) for $\frac{1}{8}$ in. hem.....	
32012	2906	Tension Disc, obsolete.....	
*32501	—	Arm, obsolete.....	
32502	2901	" Shaft, obsolete.....	
32503	2902	" " Bushing.....	
*32504	—	Bed.....	
32505	2913	" Leg.....	

## NUMERICAL LIST OF PARTS

NO.	PLATE	NAME	EACH
32506	2900	Face Plate with 32630.....	
32507	2902	Feed Bar with 1944.....	
32508	2903	" Dog, obsolete.....	
32509	2901	" Forked Connection with 175B, obsolete, use 32620.....	
32510	2902	Feed Raising Bar with 1944.....	
32511	2901	" Rock Shaft for 32512, obsolete.....	
32512	—	" " " 32511 with 32554, obsolete.....	
32513	2904	Needle Bar with 32519.....	
32514	2904	" " Bushing.....	
32515	2904	" " Connecting Link with 930F.....	
32516	2904	" " Stud with 399F, obsolete.....	
32517	2904	Needle Bar Crank with 1036c, 1134c and 1259c.....	
32518	2904	Needle Bar Thread Guard.....	
32519	2904	" Stop Pin for 32513.....	
32520	2905	Oscillating Hook.....	
32521	2905	" " Bell Crank.....	
32522	2905	Bobbins (five) for 35920.....	
32522	2905	Oscillating Hook Bobbin.....	
32523	2911	" " " Case with 591F and 32534, obsolete, use 32566.....	
32524	2905	Oscillating Hook Bobbin Case Position Bracket for 32525, obsolete, use 32591.....	
32525	—	Oscillating Hook Bobbin Case Position Bracket complete, Nos. 662b, 1137E, 32526 to 32528 and 32591, obsolete.....	
32526	2905	Oscillating Hook Bobbin Case Thread Guard for 32525, obsolete.....	
32527	2905	Oscillating Hook Bobbin Ejector for 32525 and 32592.....	
32528	2905	Oscillating Hook Bobbin Ejector Spring for 32525 and 32592.....	
32529	2905	Oscillating Hook Connecting Link.....	
32530	2906	" " Crank with 971B, obsolete, use 32594.....	
32531	2901	Oscillating Hook Pitman with two 175J.....	
32532	2901	" " Slide for 32533, obsolete.....	
32533	2911	" " " Friction Spring for 32532, obsolete.....	
32534	2911	Oscillating Hook Tension Spring for 32523, obsolete.....	
32535	2906	Presser Bar Guide Bracket with 400K and 453c.....	
32536	2906	Presser Bar Lifter.....	



## NUMERICAL LIST OF PARTS

NO.	PLATE	NAME	EACH
32537	2906	Slack Thread Regulator for 32546, obsolete.....	
32538	2906	Tension Releaser, obsolete.....	
32539	2906	" Releasing Lever, obsolete.....	
32540	2904	Thread Take-up Crank, obsolete.....	
32541	2904	" " Lever for 32542.....	
32542	—	Thread Take-up Lever complete, Nos. 32541, 32543 and 32544.....	
32543	2904	Thread Take-up Lever Hinge Stud for 32542.....	
32544	2904	Thread Take-up Lever Link for 32542.....	
32545	2906	" " Spring, obsolete.....	
32546	2906	" " " Regulator, obsolete.....	
32547	2903	Throat Plate for 32508, obsolete.....	
32548	2901	Bobbin Winder Bracket (belt cover) for 32553, obsolete.....	
32549	2907	Bobbin Winder Frame for 32553 and 32587, obsolete.....	
32550	2907	Bobbin Winder Spindle with 15072, for 32553, 32587, 32608 and 32629.....	
32551	2907	Bobbin Winder Stop Latch for 32553 and 32587, obsolete.....	
32552	2907	Bobbin Winder Thread Guide for 32553 and 32587, obsolete.....	
32553	—	Bobbin Winder complete for 2804 and 32588, Nos. 48b, 50b, 571c, 1528n, 2442, 2747, 2479, 15403, 32548 to 32552, 32557, 32564 and two 92b, obsolete.....	
32554	2902	Feed Rock Shaft Crank with 157b, for 32512, obsolete.....	
32555	2900	Clamp Stop Motion Flanged Bushing for 32556, obsolete.....	
32556	—	Clamp Stop Motion complete, Nos. 248A, 256B, 1148c, 2020 and 32555, obsolete.....	
32557	2907	Bobbin Winder Pulley for 32553, obsolete.....	
32558	2900	Presser Bar.....	
32559	2903	" Foot, obsolete.....	
32560	2906	" " Holder.....	
32561	—	Arm Side Cover, obsolete, use 32633.....	
32562	2902	Feed Cam with 1285c.....	
32563	—	Drip Pan for Drawing Room Cabinet, obsolete, use 15232.....	
32564	2907	Bobbin Winder Frame Spring for 32553 and 32587, obsolete.....	
32565	—	Presser Bar Spring, obsolete, use 3100.....	

## NUMERICAL LIST OF PARTS

NO.	PLATE	NAME	EACH
32566	2905	Oscillating Hook Bobbin Case with 1172E, 1173D and 32567, obsolete.....	
32567	2905	Oscillating Hook Bobbin Case Tension Spring for 32566 and 32590.....	
32568	—	No. cancelled, order 32582.....	
32569	2900	Oscillating Hook Slide.....	
32570	2902	" " " Friction Spring.....	
32571	2903	Throat Plate for 32508, obsolete.....	
32572	2911	Tension Releasing Disc for 32654.....	
32573	2911	" " Lever.....	
Nos. 32574 to 32576 for 32654.			
32574	2911	Tension Releasing Pin.....	
32575	2911	Thread Take-up Spring.....	
32576	2911	" " " Regulator.....	
32577	2920	Arm Shaft, obsolete.....	
32578	2911	Thread Take-up Crank.....	
32579	2921	Slack Thread Regulator for 32576, obsolete, use 32621.....	
32580	2911	Needle Bar Connecting Stud with 1353c.....	
32581	2920	Feed Rock Shaft.....	
32582	2921	" Cover Plate with 1423b and 32583, for art work, obsolete.....	
32583	2921	Feed Cover Plate Position Stud for 32582, obsolete.....	
32584	2919	Balance Wheel (light rim) 2½ in. pulley, for 32556, for Drawing Room Cabinet, obsolete.....	
32585	2913	Bobbin Winder Bracket (belt cover) for 32587, obsolete.....	
32586	2921	Bobbin Winder Pulley for 32587, obsolete.....	
32587	—	Bobbin Winder complete for 2008 and 32584, Nos. 48b, 50b, 571c, 1528n, 2442, 2747, 2749, 15403, 32549 to 32552, 32564, 32585, 32586 and two 92b, obsolete.....	
32588	2922	Balance Wheel (light rim) 3 in. pulley, for 32556, for Cabinet Table, obsolete.....	
32589	2926	Feed Cover Plate (oval top) for art work.....	
32590	2921	Oscillating Hook Bobbin Case with 1172E, 1173D and 32567.....	
32591	2921	Oscillating Hook Bobbin Case Position Bracket for 32525 and 32592.....	
32592	—	Oscillating Hook Bobbin Case Position Bracket complete, Nos. 662D, 1137E, 32527, 32528, 32591, 32593, 32598 and 32599.....	

NO.	PLATE	NAME	EACH
32593	2921	Oscillating Hook Bobbin Case Cushion Spring for 32592	
32594	2911	Oscillating Hook Crank with 1485j	
32595	—	Nos. cancelled.	
32596	—		
32597	—		
32598	2921	Oscillating Hook Bobbin Case Position Bracket Oil Pad (felt) for 32592, per 100	
32599	2921	Oscillating Hook Bobbin Case Position Bracket Oil Pad Holder for 32592	
32600	2903	Feed Dog	
32601	2903	Presser Foot	
32602	2903	Throat Plate for 32600	
32603	—	Hand Attachment complete with Bobbin Winder for 32588, Nos. 48b, 50b, 134d, 233b, 571c, 659d, 660d, 1528u, 2460, 2461, 2532, 2749, 8280, 8284 to 8286, 8313, 8377, 8392 to 8394, 15296, 15403, 32609 to 32614 and two each 92b, 183e, 399a and 2747, obsolete	
32604	2912	Bobbin Winder Bracket (belt cover) for 32608 and 32629	
32605	—	No. cancelled, order 32550.	
32606	6314	Bobbin Winder Stop Latch for 50060b, obsolete	
32607	6314	Bobbin Winder Thread Guide for 15293, obsolete	
32608	—	Bobbin Winder (automatic) complete for 15282, Nos. 50b, 571c, 1528u, 2749, 15285 to 15288, 15291, 15366, 15376, 15403, 32550, 32604, 32623, 32625, 50058b, 50059b, 50061b and 50230b, obsolete, use 32629	
Nos. 32609 to 32614 FOR 32603, OBSOLETE.			
32609	2912	Hand Attachment Body Bracket with 8312 and two 145b	
32610	2916	Hand Attachment Bobbin Winder Bracket	
32611	2916	" " " " Frame	
32612	2916	" " " " Spindle with 15072	
32613	2916	Hand Attachment Bobbin Winder Stop Latch	
32614	2916	Hand Attachment Bobbin Winder Thread Guide	
32615	2920	Arm Shaft, obsolete	

NO.	PLATE	NAME	EACH
*32616	—	Arm	
32617	2920	" Shaft	
32618	2912	Clamp Stop Motion Flanged Bushing for 32619	
32619	—	Clamp Stop Motion complete, Nos. 248A, 256b, 1148c, 2020 and 32618	
32620	2912	Feed Forked Connection with 175b	
32621	2911	Slack Thread Regulator	
32622	2926	Feed Cover Plate (flat top) for art work	
32623	6314	Bobbin Winder Thread Guide for 32608, obsolete	
32625	6314	Bobbin Winder Stop Latch for 32608 and 32629	
32628	6314	Bobbin Winder Thread Guide for 32629	
32629	—	Bobbin Winder (automatic) complete for 15282, Nos. 50b, 571c, 1528u, 15286, 15287, 15291, 15366, 15376, 15413, 15414, 15416, 15424, 32550, 32604, 32625, 32628, 50058b, 50059b, 50061b and 50230b	
32630	2902	Face Plate Thread Guard with 8505, for 32506	
32633	2900	Arm Side Cover (embossed)	
32634	2923	Presser Foot, for stitching on edges and inserting cord	
32654	—	Tension complete, Nos. 1274e, 1560b, 8238, 32572, 32574 to 32576 and two 2102	
33642	6310	Hand Attachment Driver for 33646, obsolete	
33643b	—	Hand Attachment Driver Finger for 94007b	
33646	—	Hand Attachment complete for 32616, Nos. 137b, 659d, 660d, 2532, 8280, 8377, 8386 to 8388, 8392 to 8394, 8436, 33642, 33647, 94007b and two each 183e and 399a, obsolete	
33647	4915	Hand Attachment Body Bracket for 33646 and 94001b	
Nos. 35002 to 35006 FOR 36084.			
35002	2927	Presser Foot Extension	
35003	2927	" " Graduated Adjustable Guide (long, left)	
35004	2927	Presser Foot Graduated Adjustable Guide (long, right)	

NO.	PLATE	NAME	EACH
35005	2927	Presser Foot Graduated Adjustable Guide (short, right).....	
35006	2927	Presser Foot Graduated Adjustable Guide (short, right) flush.....	
35049	1017	Embroidery Attachment Frame with 35050, for 35051.....	
35050	1017	Embroidery Attachment Frame Bracket for 35049.....	
35051	1017	Embroidery Attachment complete, for one thread, Nos. 190D, 240D, 26521, 26523, 26528 to 26530, 26533, 26535, 26537, 26784, 26785, 35049, 36611, 36695 and two 22232.....	
35113	2918	Corder Bow for 35114.....	
35114	2918	Corder (bow) complete, for top cording, Nos. 4604, 25789, 35113 and 35115.....	
35115	2918	Presser Foot for 35114.....	
35142	—	Hemmer (foot) for $\frac{3}{8}$ in. hem..... Nos. 35485 to 35487 for 35853.	
35485	935	Embroidery Attachment Driving Lever	
35486	935	“ “ “ “ Arm (lower).....	
35487	935	Embroidery Attachment Driving Lever Arm (upper)..... Nos. 35489 to 35495 for 35853.	
35489	935	Embroidery Attachment Driving Lever Arm Hinge Stud.....	
35490	935	Embroidery Attachment Driving Lever Arm Spring.....	
35491	935	Embroidery Attachment Driving Lever Hinge Stud.....	
35492	935	Embroidery Attachment Thread Carrier (left).....	
35493	935	Embroidery Attachment Thread Carrier (left) Hinge Stud.....	
35494	935	Embroidery Attachment Thread Carrier (right).....	
35495	935	Embroidery Attachment Thread Carrier Friction Plate.....	
35497	936	Embroidery Attachment Spool Bracket for 35504.....	
35498	936	Embroidery Attachment Spool Bracket Stud for 35853..... Nos. 35499 to 35503 for 35504.	
35499	936	Embroidery Attachment Spool Bracket Tension Spring.....	

NO.	PLATE	NAME	EACH
35500	936	Embroidery Attachment Spool Bracket Tension Spring Position Pin.....	
35500	936	Embroidery Attachment Spool Bracket Thread Guide Pin.....	
35501	936	Embroidery Attachment Spool Bracket Wire.....	
35502	936	Embroidery Attachment Spool Bracket Wire Hinge Stud.....	
35503	936	Embroidery Attachment Spool Bracket Wire Hinge Stud Washer.....	
35504	936	Embroidery Attachment Spool Bracket complete for 35854, Nos. 1422B, 35497, 35499, 35502, 35503 and two each 35500 and 35501.....	
35506	2903	Presser Foot, for etching.....	
35554	2923	Hemmer (foot) narrow, for chiffon and silk.....	
35555	—	Hemmer (foot) wide, for chiffon and silk.....	
35833	2923	Feller (foot)..... Nos. 35850 to 35852 for 35853.	
35850	934	Embroidery Attachment Body.....	
35851	934	“ “ “ Block....	
35852	934	“ “ Driving Lever Arm Guide.....	
35853	934	Embroidery Attachment for 35854, Nos. 4604, 35485 to 35487, 35490 to 35495, 35498, 35850 to 35852, 50139B and two 35489.....	
35854	—	Embroidery Attachment complete, for two threads, Nos. 35504 and 35853.....	
35920	—	Attachment Set complete, Nos. 287B, 25525, 25527B, 25537 to 25539, 35957, 35958, 35961, 35963, 36584, 36595, five 32522 and six needles.....	
35957	5640	Hemmer (adjustable) for 35920.....	
35958	5640	Quilter for 35920.....	
35960	5642	Ruffler Shirring Plate for 35961.....	
35961	—	“ 36518 with 35960, for 35920.....	
35963	5642	Under Braider for 35920.....	
35983	2927	Strip Wire for 35987.....	
35986	2927	Presser Foot (strip folding) with tube, for 35987.....	
35987	—	Tubular Trimming Attachment complete, for making $\frac{3}{8}$ in., $\frac{1}{8}$ in. and $\frac{5}{8}$ in. trimmings, Nos. 25539, 35983 and 35986.....	

## NUMERICAL LIST OF PARTS

NO.	PLATE	NAME	EACH
36074	2927	Presser Foot with 665B and 36075, for blind stitch braiding for soutache braid	
36075	2927	Presser Foot Braid Guide for 36074.....	
		Nos. 36081 TO 36083 FOR 36084.	
36081	2927	Presser Foot.....	
36082	2927	" " Graduated Adjustable Guide Clamp.....	
36083	2927	Presser Foot Graduated Adjustable Guide Clamp Lever.....	
36084	—	Presser Foot with Extension and Graduated Adjustable Guides complete, Nos. 337B, 35002 to 35006 and 36081 to 36083.....	
36090	2928	Tuck Folder Arm with 50C68E, for 36091	
36091	2928	Tuck Folder complete, for small pieces of goods, Nos. 171A, 1704B, 1705B, 19044, 36090, 50066E, 50C67D, 202600, 202603B, 225923, 225926 and two 1483H.....	
36093	2927	Presser Foot for 36091.....	
36108	2927	" " " darning.....	
36518	5640	Ruffler for 35961.....	
36569	2913	Oiler with 36571, for 36570.....	
36570	—	" 36569 filled with oil (Accessories)...	
36571	2913	" Spout, 1¾ in. long, with 36807, for 36569.....	
36584	2925	Tucker complete for 35920, Nos. 36655 to 36657, 36659 to 36661, 36663, 36665 to 36667 and two each 36658, 50238B and 86354.....	
36595	5640	Binder for 35920.....	
36611	1018	Embroidery Attachment Looper for 35051	
36648	2924	Tucker Tuck Marker Rivet for 36663, .....per 100	
		Nos. 36655 TO 36661 FOR 36584.	
36655	2924	Tucker Driving Lever.....	
36656	2924	" " " Hinge Stud.....	
36657	2924	" " " Lock Spring.....	
36658	2924	" " " " " Rivet, .....per 100	
36659	2924	Tucker Frame.....	
36660	2924	" Tuck Guide.....	
36661	2924	" " " Thumb Screw Washer	
36662	2924	" " Marker (lower) for 36663...	
36663	—	" " " " 36662 with 36664 and two 36648, for 36584.....	
36664	2924	Tucker Tuck Marker (upper) for 36663..	

## NUMERICAL LIST OF PARTS

NO.	PLATE	NAME	EACH
		Nos. 36665 TO 36667 FOR 36584.	
36665	2924	Tucker Tuck Marker Clamping Plate	
36666	2924	" " " " " Rivet.....per 100	
36667	2924	Tucker Tuck Smoothing Spring.....	
36695	1018	Embroidery Attachment Scroll Cover for 35051.....	
36787	2923	Presser Foot, for gathering.....	
36807	2929	Oiler Spout Washer (leather) for 36571...	
36867	5642	Edge Stitcher.....	
		Nos. 46506 TO 46509 FOR 28248, 28260 AND 46624.	
46506	3826	Pitman Ball Bearing Adjusting Screw Ring.....	
46507	3826	Pitman Ball Bearing Adjusting Screw Ring Locking Washer (brass)...per 100	
46508	3826	Pitman Ball Bearing Ring.....	
46509	3826	" " Case.....	
46510	6321	" Rod with 25360, for 46624.....	
46511	—	Band Wheel Crank and Pitman (ball bearing) complete for 82953, Nos. 46624 and 46630.....	
46515	6321	Band Wheel Crank for 28260 and 46624.	
46525	2913	Belt Shifter for 25049.....	
46526	—	Dress Guard for 25049.....	
46612	2913	Skeleton Drawer Case Support with two wood screws ½ in. No. 7 R. H. B. (Trimnings for Cabinet Table).....	
46624	—	Band Wheel Crank and Pitman (ball bearing) complete for 46511, Nos. 1520E, 25371, 46506 to 46510, 46515, 46655 and six 25362.....	
46629	—	Band Wheel Crank Screw Centre 297c with 1507J, for 82896.....	
46629	—	Treadle Screw Centre 297c with 1507J, for 82896.....	
46630	—	Pitman Rod Ball Screw Bearing 25361 with 1670E, for 46511.....	
46655	3826	Pitman Ball Separator for 28248, 28260 and 46624.....	
50058B	6313	Bobbin Winder Adjusting Arm Screw for 32608 and 32629.....	
50059B	6313	Bobbin Winder Frame Hinge Screw for 32608 and 32629.....	
50060B	6313	Bobbin Winder Stop Latch Hinge Screw for 32606, obsolete.....	

## NUMERICAL LIST OF PARTS

NO.	PLATE	NAME	EACH
50061B	6313	Bobbin Winder Thread Guide Hinge Screw for 32608 and 32629.....	
50066E	2929	Tuck Folder Screw Stud for 36091.....	
50067D	2929	" " " " Cap Screw for 36091.....	
50068E	2929	Tuck Folder Space Gauge Screw Stud for 36090.....	
50139B	935	Embroidery Attachment Thread Carrier (right) Hinge Screw for 35853.....	
50230B	6313	Bobbin Winder Stop Latch Hinge Screw for 32608 and 32629.....	
50238B	2924	Tucker Tuck Guide Thumb Screw for 36584.....	
50238B	2924	Tucker Tuck Marker Clamping Plate Thumb Screw for 36584.....	
50251E	2910	Counterbalance Spring Adjusting Collar Bolt with 1734E, for 56264.....	
50289B	6413	Handle Bolt for 87550.....	
50380C	6317	Machine Hinge Connection Set Screw (Trimings for Cabinet Table, Drawing Room Cabinet, Open Side Drawing Room Cabinet and Portable Case)....	
56251	6316	Cover Lock (Trimings for Portable Case)	
56252	2915	Treadle Screw Centre Bracket with 297c and 1507j (Trimings for Drawing Room Cabinet).....	
56253	2917	Pitman Rod Ball Screw Bearing for 56317	
56254	4270	Door Lock Plate (Trimings for Open Side Drawing Room Cabinet).....	
*56255	—	Rocking Frame 56257 with two each 28043 and 28045, for 28041.....	
*56257	—	Rocking Frame for 56255.....	
56258	6317	Centre Drawer Stop Pin (Trimings for Cabinet Table).....	
56260	6321	Counterbalance Spring for 56264.....	
56261	6321	" " Adjusting Collar " " for 56264.....	
56262	6321	Counterbalance Spring Bracket (hinge) for 56319.....	
56263	6321	Machine Lifting Plate for 56319.....	
56264	6321	Machine Lifting Plate complete, Nos. 9281, 50251E, 56260, 56261 and 56319 (Trimings for Cabinet Table and Open Side Drawing Room Cabinet).....	
56317	—	Pitman Rod Ball Screw Bearing 56253 with 1670E, for 28248 and 28260.....	

## NUMERICAL LIST OF PARTS

NO.	PLATE	NAME	EACH
*56319	—	Machine Lifting Plate 56263 with 28123 and 56262, for 56264.....	
Nos. 56323 TO 56325 FOR 56326.			
56323	6429	Latch.....	
56324	6429	" Button.....	
56325	6429	" Frame.....	
56326	6429	Latch complete, Nos. 5604, 28034, 28200, 56323 to 56325 and 56438 (Trimings for Drawing Room Cabinet).....	
56429	2917	Partition Lock (revolving bolt) double (Trimings for Cabinet Table).....	
56430	2917	Partition Lock (revolving bolt) single (Trimings for Cabinet Table).....	
56438	6317	Latch Button Hinge Pin for 56326.....	
56814	—	Feed Rock Shaft Screw Centre 307c with 1513j.....	
80018	4916	Hand Attachment Driver Finger Hinge Pin for 94001B.....	
80023	4915	Hand Attachment Crank Handle (wood) for 94005B.....	
80027	4916	Hand Attachment Pinion for 94001B....	
80028	4916	" " " Dowel Pin for 94001B.....per 100	
82887	—	Belt, size $\frac{3}{8}$ in., length 68 in., with 25027, for 82953.....	
82896	6321	Brace with three 46629 for 82953.....	
82953	—	Stand (iron work) rocking treadle, ball bearing pitman, cabinet table, complete, Nos. 504E, 1288E, 25049, 25086, 25200, 25406, 25439, 25442, 46511, 82896, two 25444 and four 748E.....	
84151	6413	Machine Button Washer (leather) for 87342.....	
86354	2924	Tucker Tuck Smoothing Spring Rivet for 36584.....per 100	
87342	6413	Machine Button with 84151 and wood screw 1 in. No. 9 R. H. B. (Trimings for Portable Case).....	
87363	712	Drawer Lock Key (Trimings for Drawing Room Cabinet).....	
87427	6413	Cover Lock Plate (Trimings for Portable Case).....	
87428	6413	Cover Hook (Trimings for Portable Case).....	
87431	6413	Cover Hook Plate (Trimings for Portable Case).....	

NO.	PLATE	NAME	EACH
87550	—	Handle complete, Nos. 28088, 28231, 87555, two each NN831, 28229, 50289b and 87558 (Trimnings for Portable Case).....	
87555	2930	Cover Reinforcing Plate for 87550.....	
87558	6413	Handle Link for 87550.....	
87571	6317	Machine Hinge Head for 87573.....	
87572	6317	“ “ “ Screw Washer for 87573.....	
87573	—	Machine Hinge complete, Nos. SS368b, 8294, 8295, 87571 and 87572 (Trimnings for Drawing Room Cabinet and Portable Case).....	
87581	6413	Base Lid Catch Plate with wood screws $\frac{3}{8}$ in. No. 3 R. H. nicked and $\frac{1}{4}$ in. No. 3 R. H. nicked (Trimnings for Portable Case).....	
87582	6413	Base Lid Catch Plate Pin (Trimnings for Portable Case).....	
87605	6317	Centre Drawer Hinge Bracket with two wood screws $\frac{1}{2}$ in. No. 7 (Trimnings for Cabinet Table).....	
87606	6317	Centre Drawer Hinge Bracket Plate with two wood screws $\frac{1}{2}$ in. No. 7 (Trimnings for Cabinet Table).....	
94001B	—	Hand Attachment complete for Machine 66-3, Nos. 137b, SS380b, SS381b, 8280, 8388, 33647, 80018, 80027, 80028, 94002, 94005b to 94007b, 94008, 94010, 94011 and two each 183E and 211A....	
*94002	4915	Hand Attachment Body for 94001b.....	
94005B	—	Hand Attachment Crank complete for 94001b, Nos. 8435b, 80023 and 94012.	
94006B	4916	Hand Attachment Driver for 94001b....	
94007B	4916	“ “ “ Finger 33643b, with 8390, 8391 and 94009, for 33646 and 94001b.....	
94008	4916	Hand Attachment Driver Finger Lock Pin for 94001b.....	
94009	4916	Hand Attachment Driver Finger Sheath (leather) for 94007b.....	
94010	4915	Hand Attachment Gear with 8281 and 8282, for 94001b.....	
94011	4915	Hand Attachment Gear Cover for 94001b	
94012	4915	“ “ Crank Handle Spindle for 94005b.....	

NO.	PLATE	NAME	EACH
202600	2929	Tuck Folder Screw Stud Thumb Nut Washer for 36091.....	
202603B	2929	Tuck Folder Space Gauge Screw Stud Thumb Nut Washer for 36091.....	
225923	2928	Tuck Folder for 36091.....	
225926	2928	“ “ Space Gauge for 36091.....	

**ILLUSTRATIONS OF PARTS**

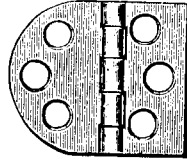
**FOR**

**MACHINES**

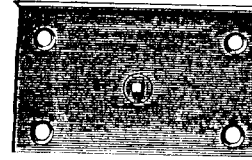
**Nos. 66-1 and 66-3**

PLATE 712—ONE-HALF SIZE

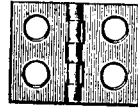
28235



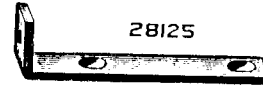
28073



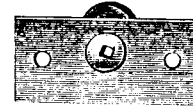
28253



28125



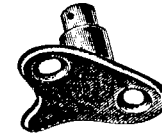
28021



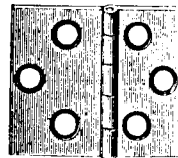
28015



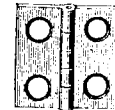
28044



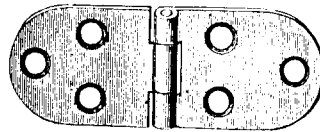
28121



28024



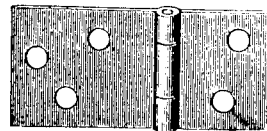
28234



28026



28079

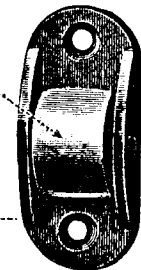


28037

87363

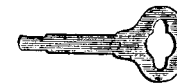


28019



28029

28233



28016

28030

28017

28033

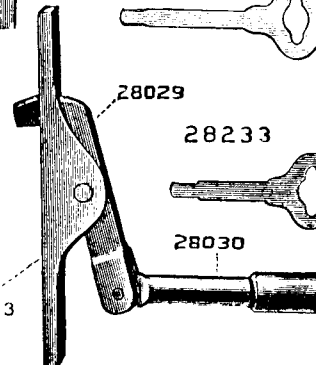
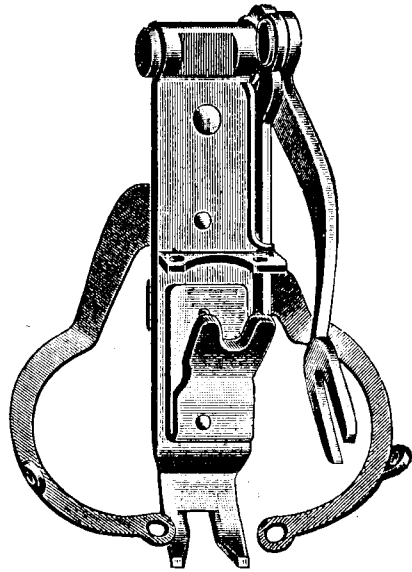


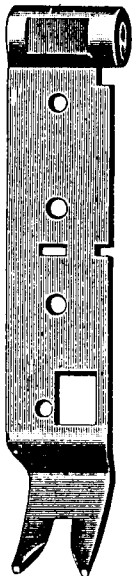


PLATE 934—FULL SIZE

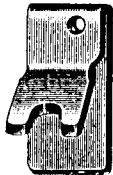
35853



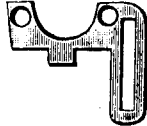
35850



35851



35852

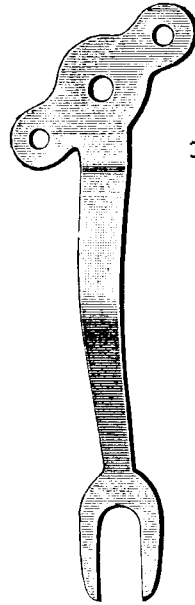


4604



PLATE 935—FULL SIZE

35485



35486

35491



35489



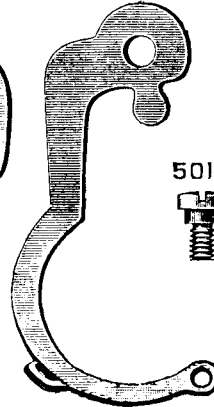
35487



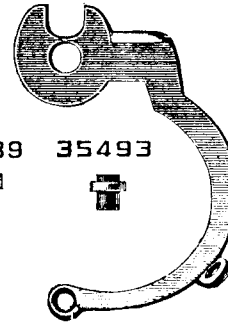
35495



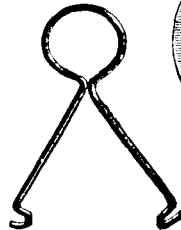
35492



35494



35490



50139



35493



PLATE 936—FULL SIZE

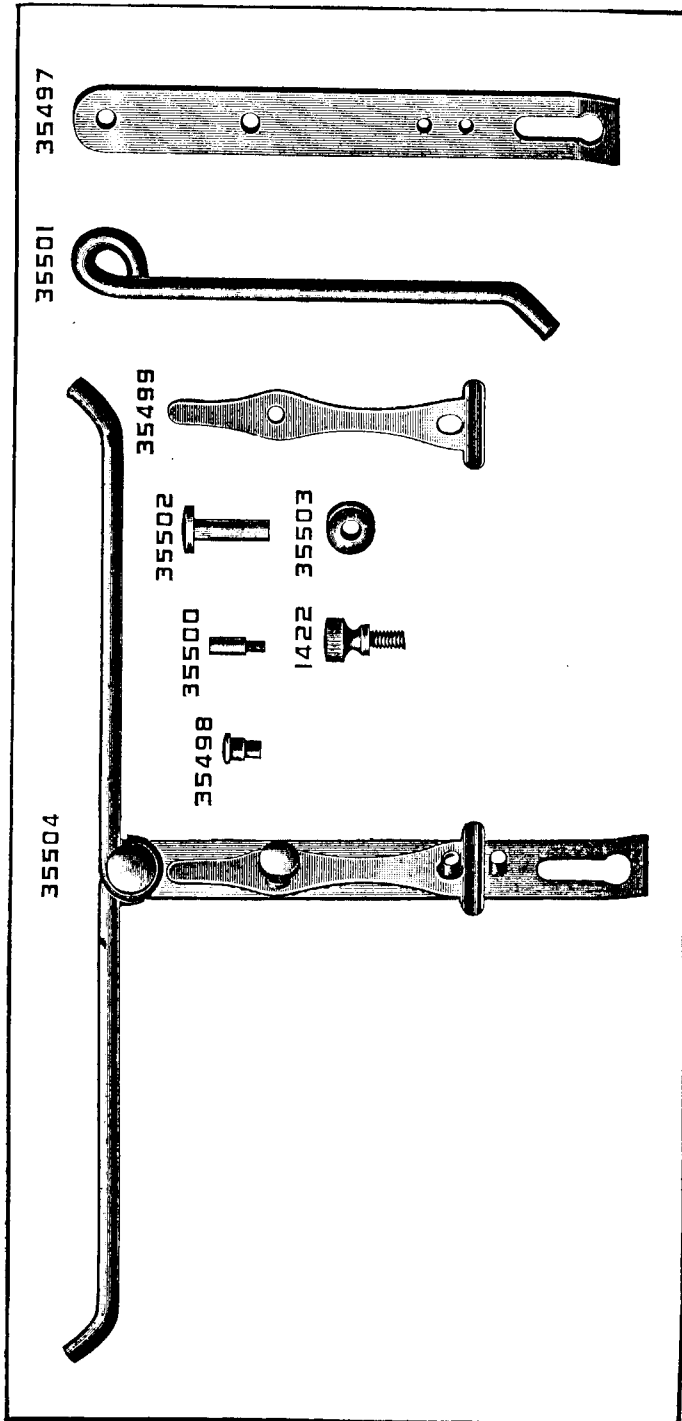


PLATE 1017—FULL SIZE

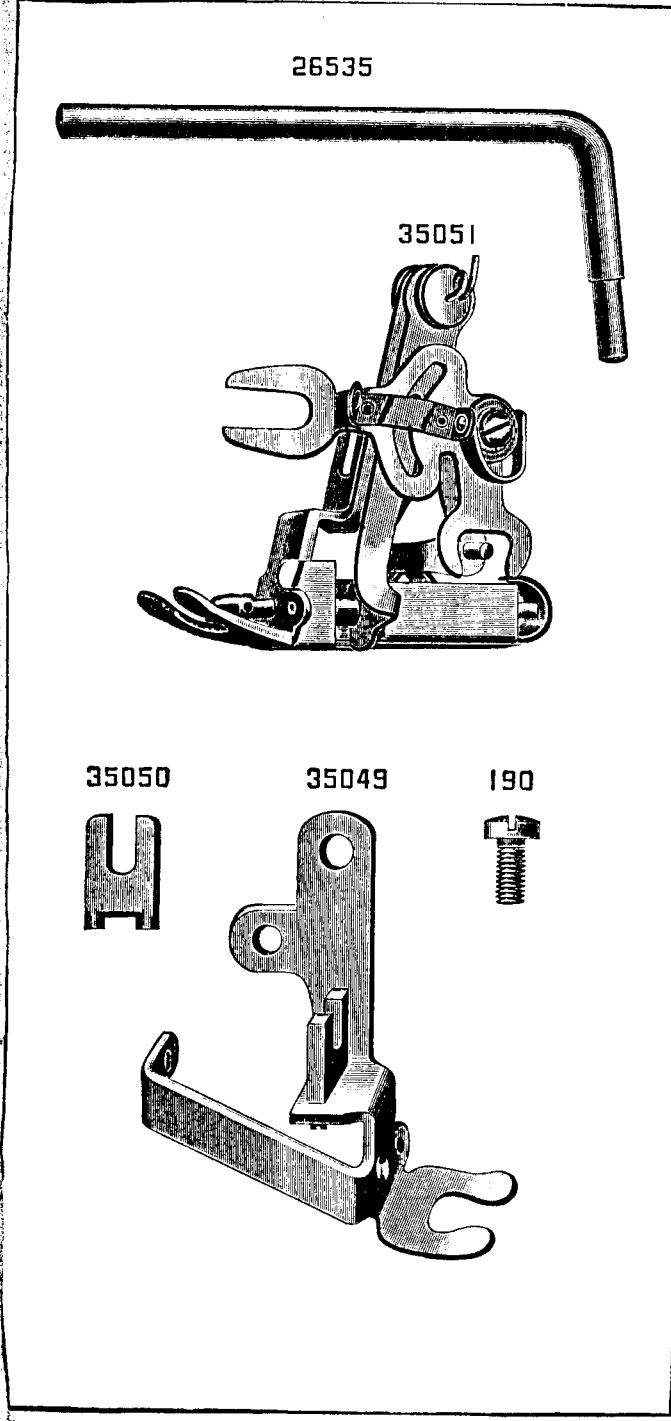


PLATE 1018—FULL SIZE

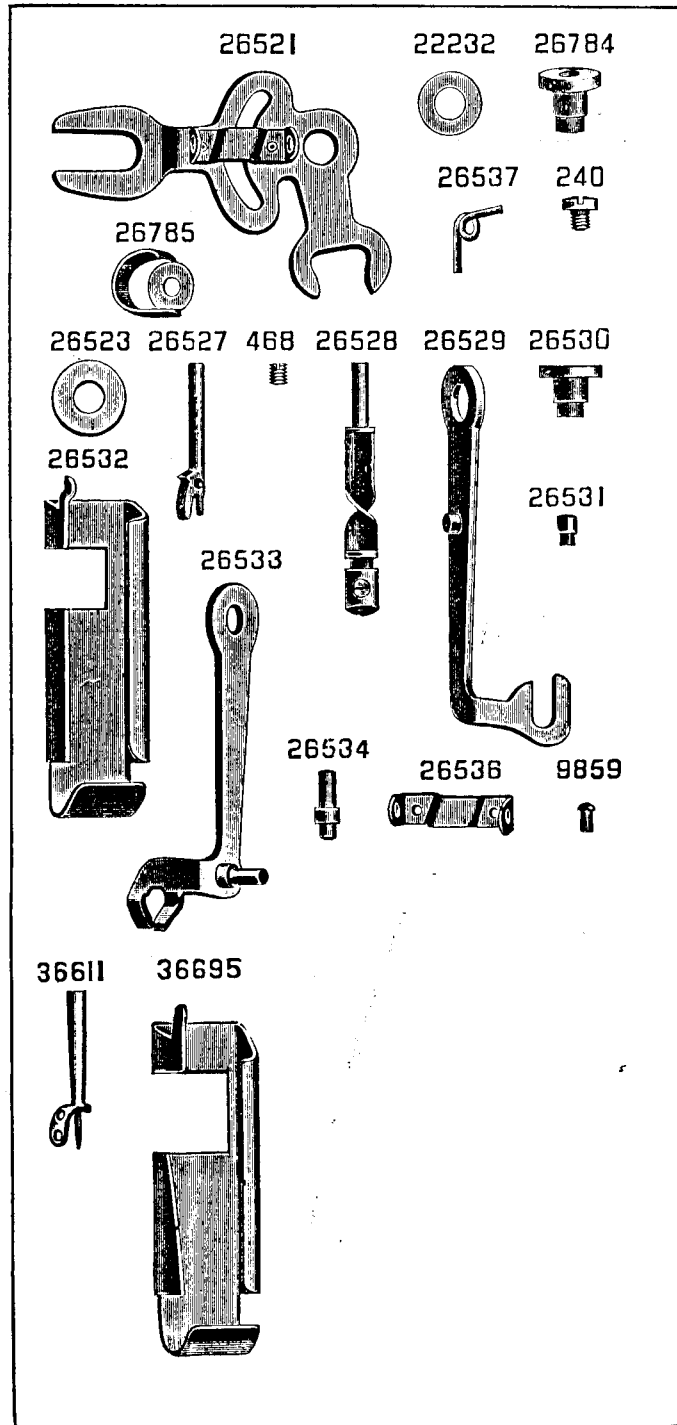


PLATE 1962—ONE-FOURTH SIZE

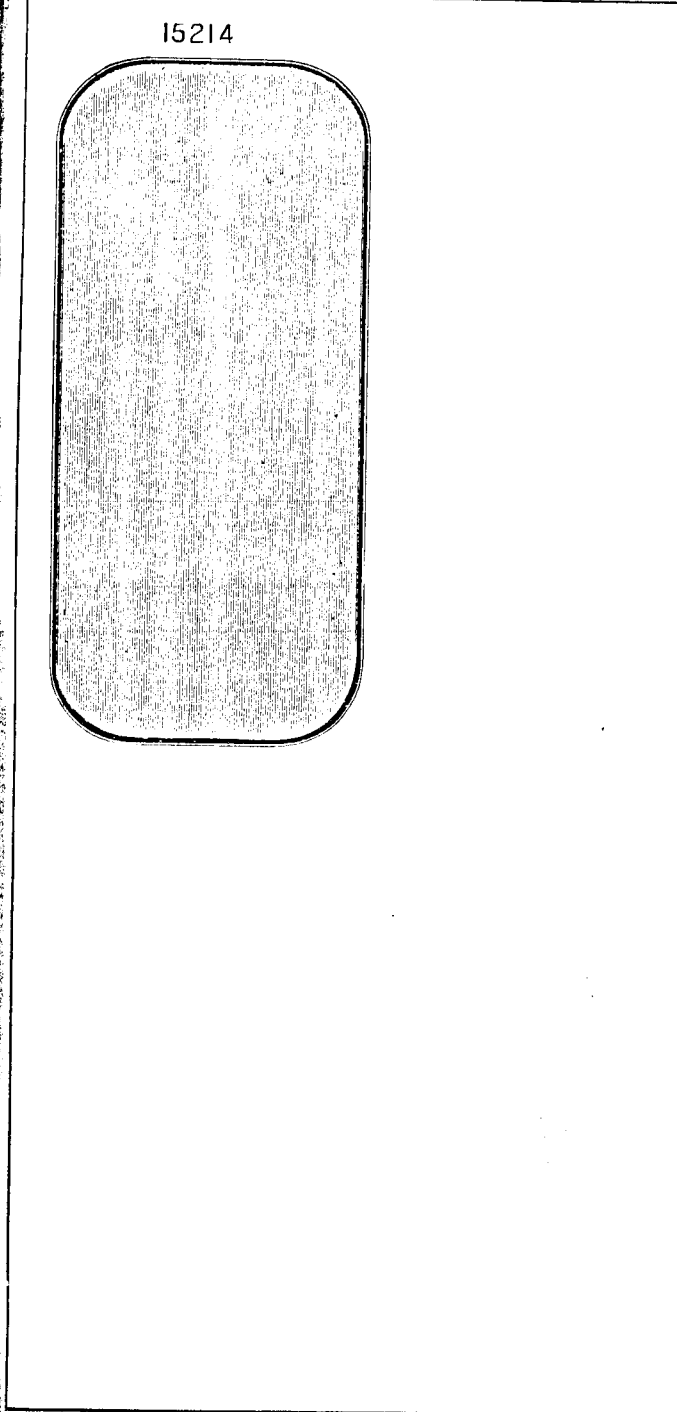
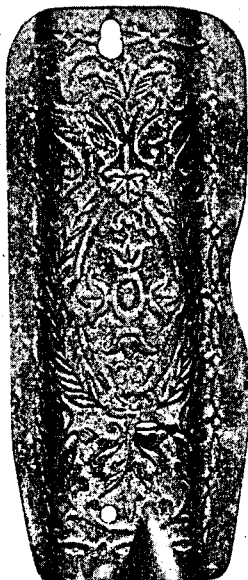


PLATE 2900—ONE-HALF SIZE

32506



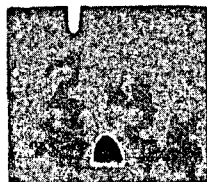
32633



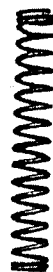
32558



32569



3100



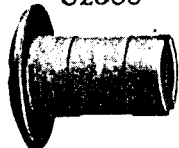
2020



256



32555



2804

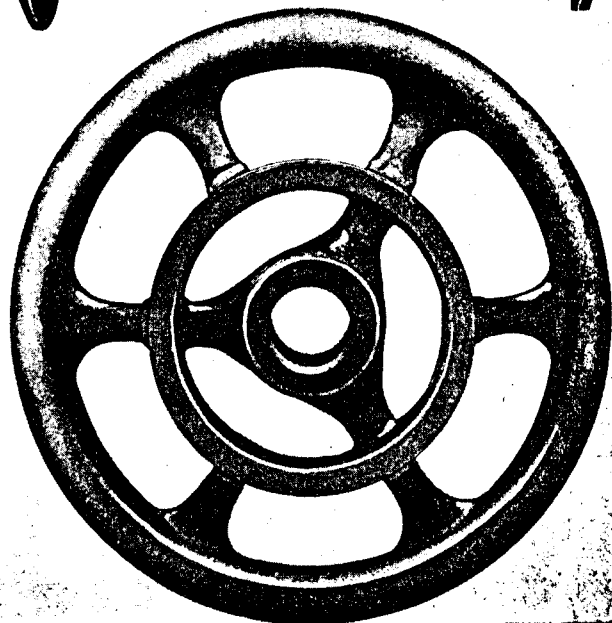
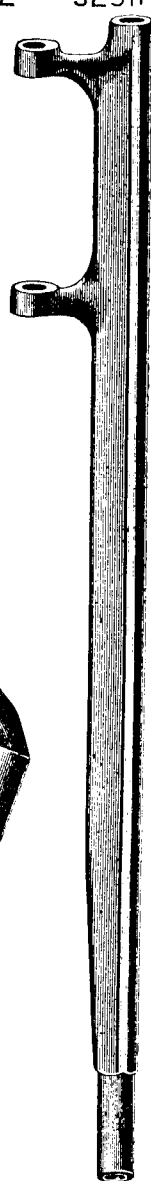


PLATE 2901—ONE-HALF SIZE

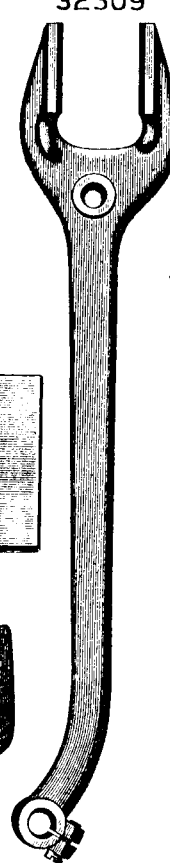
32502



32511



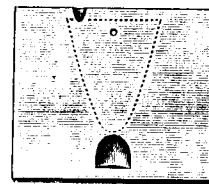
32509



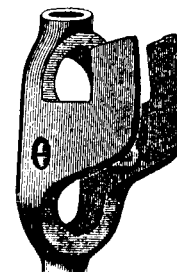
32531



32532



8203



32548

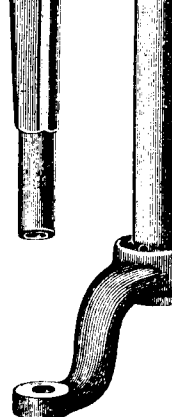
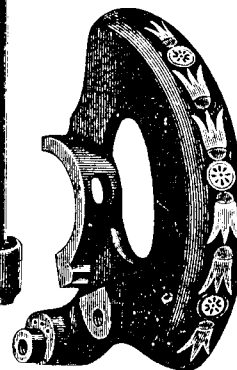


PLATE 2902—FULL SIZE

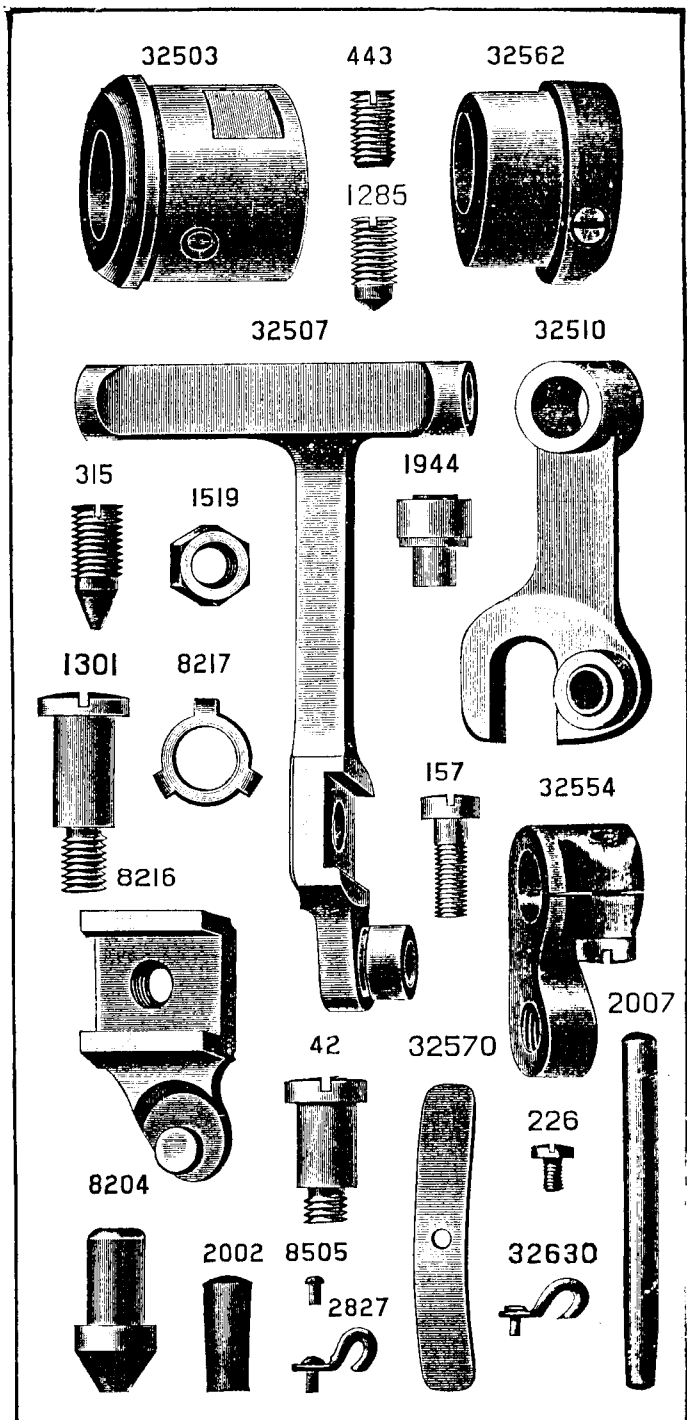


PLATE 2903—FULL SIZE

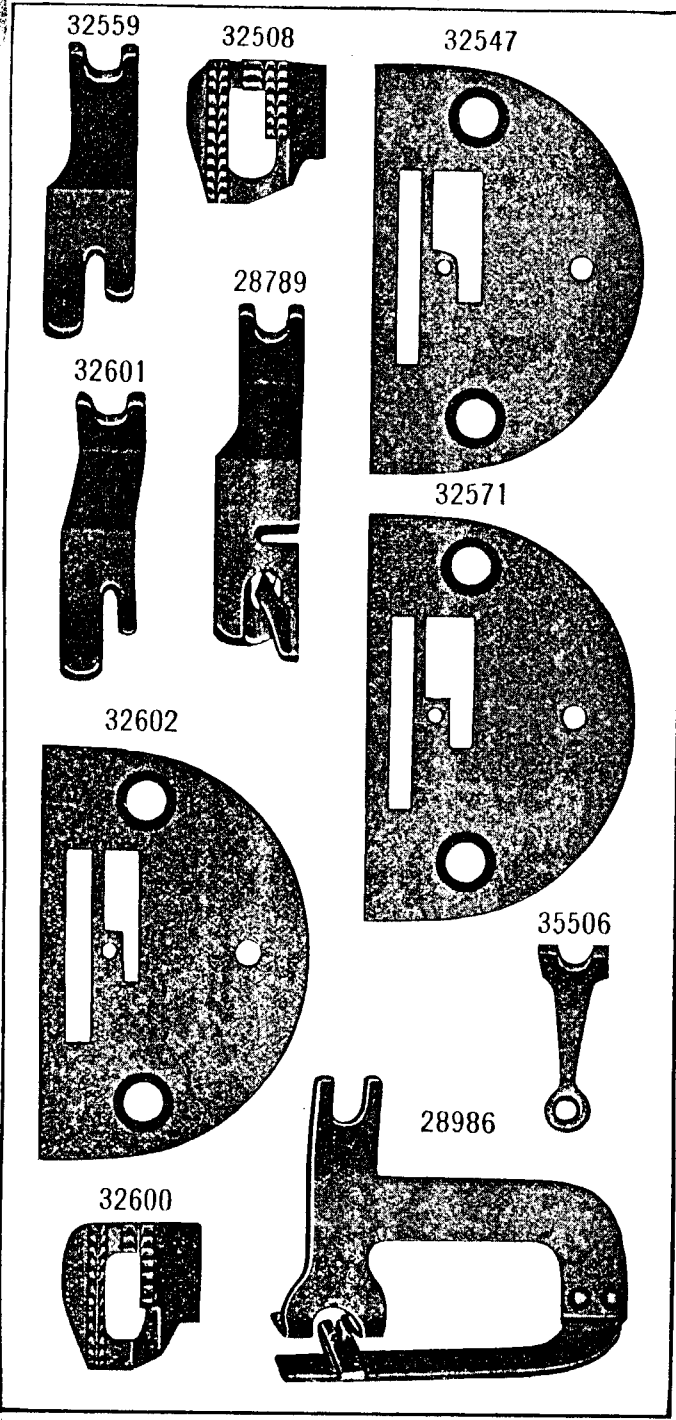


PLATE 2904—FULL SIZE

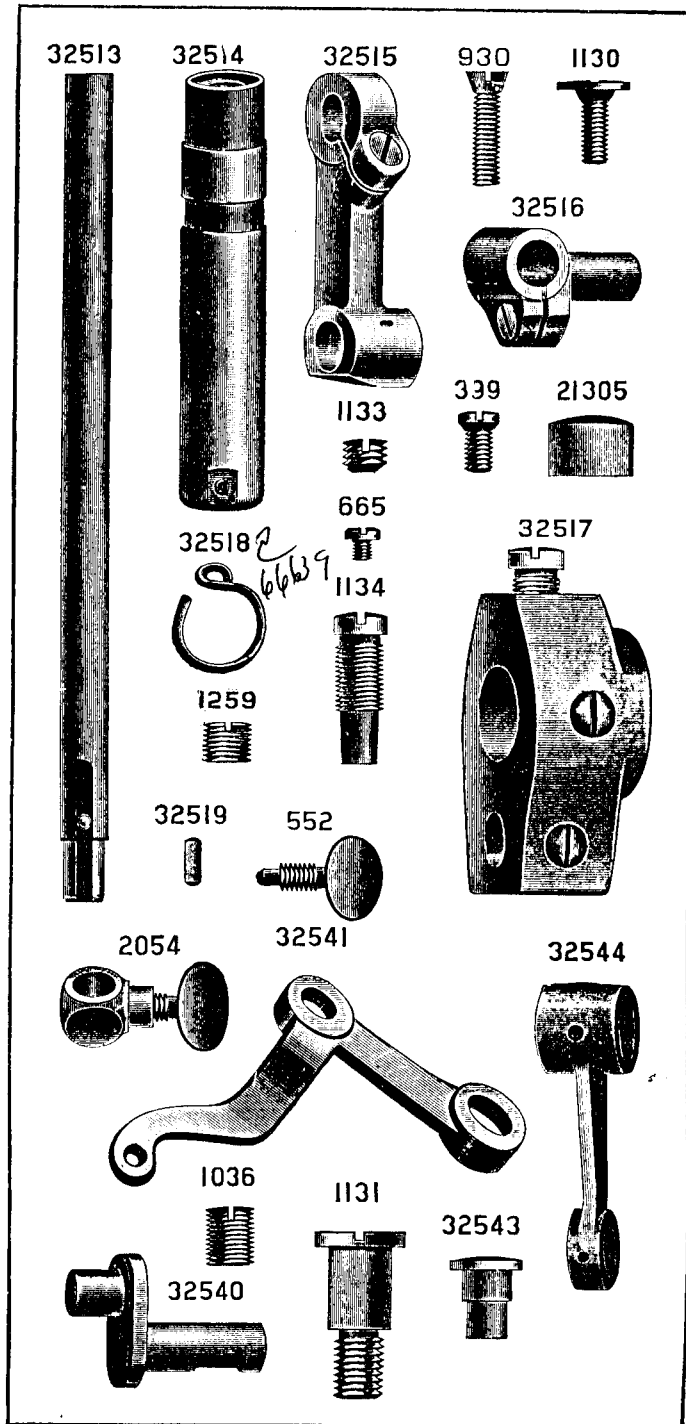


PLATE 2905—FULL SIZE

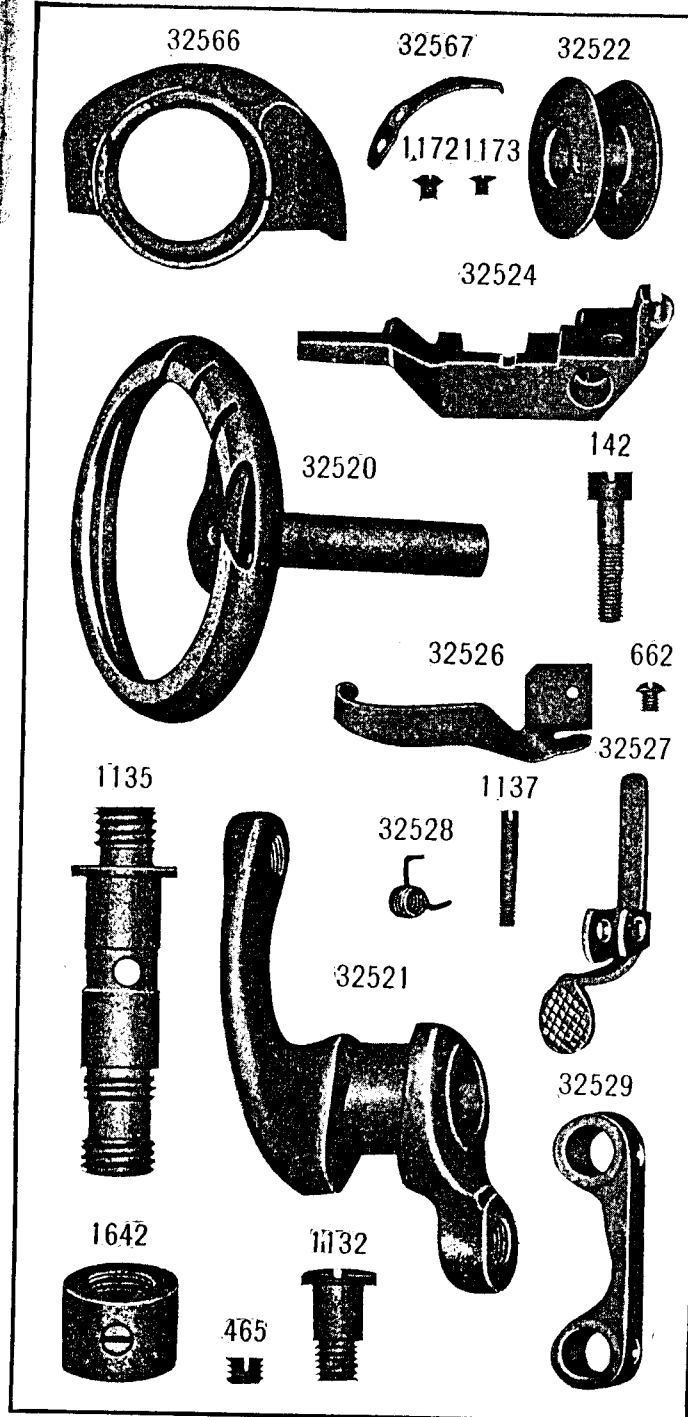


PLATE 2906—FULL SIZE

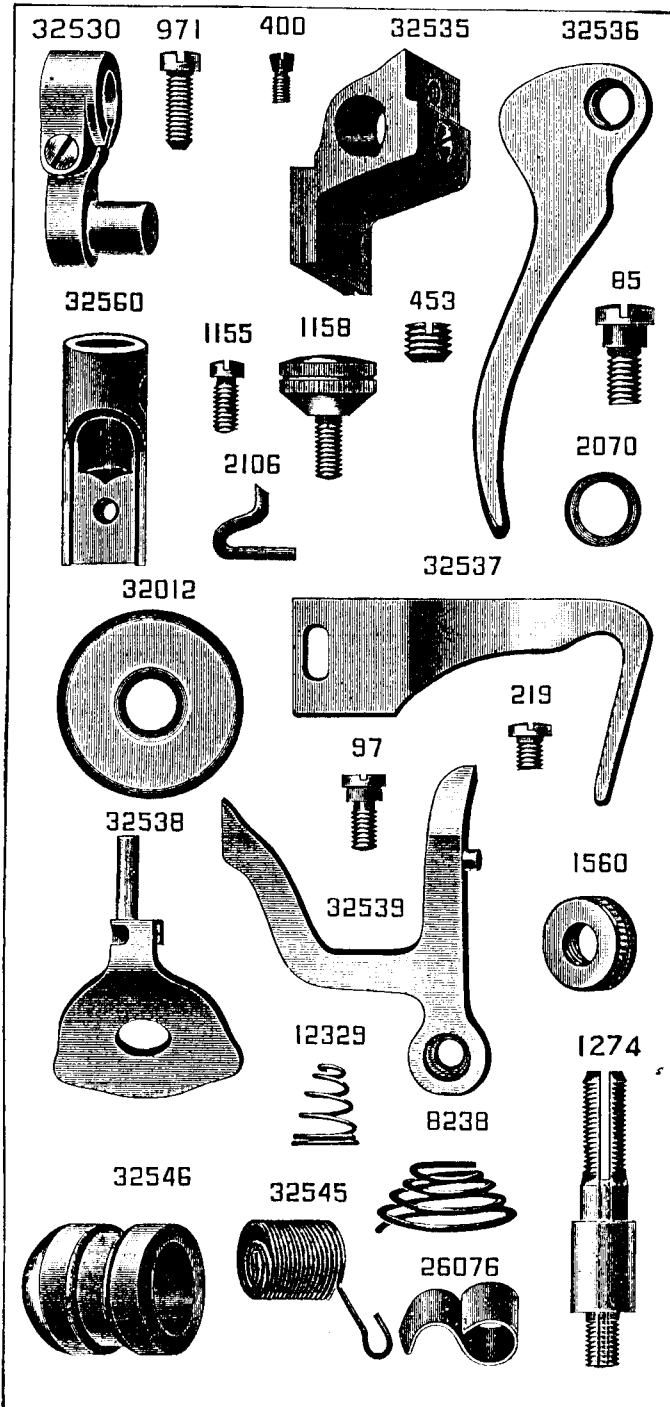


PLATE 2907—FULL SIZE

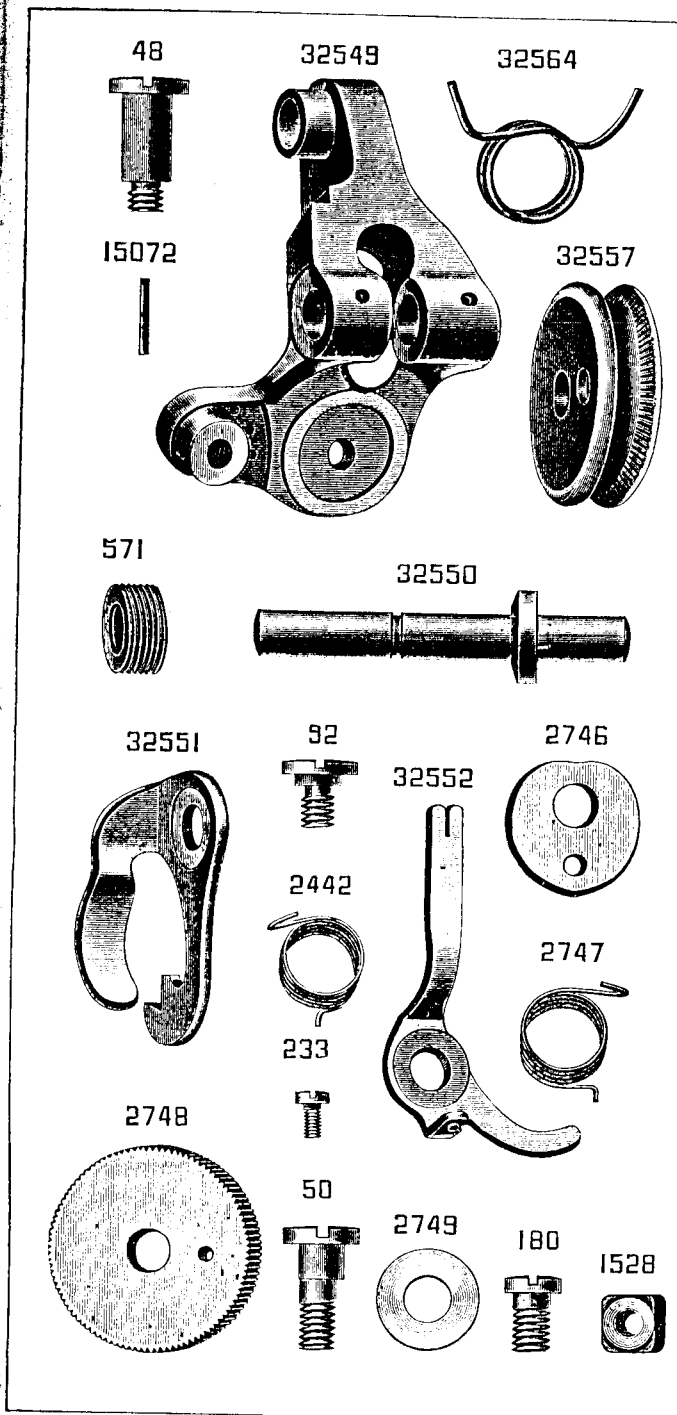


PLATE 2908—FULL SIZE

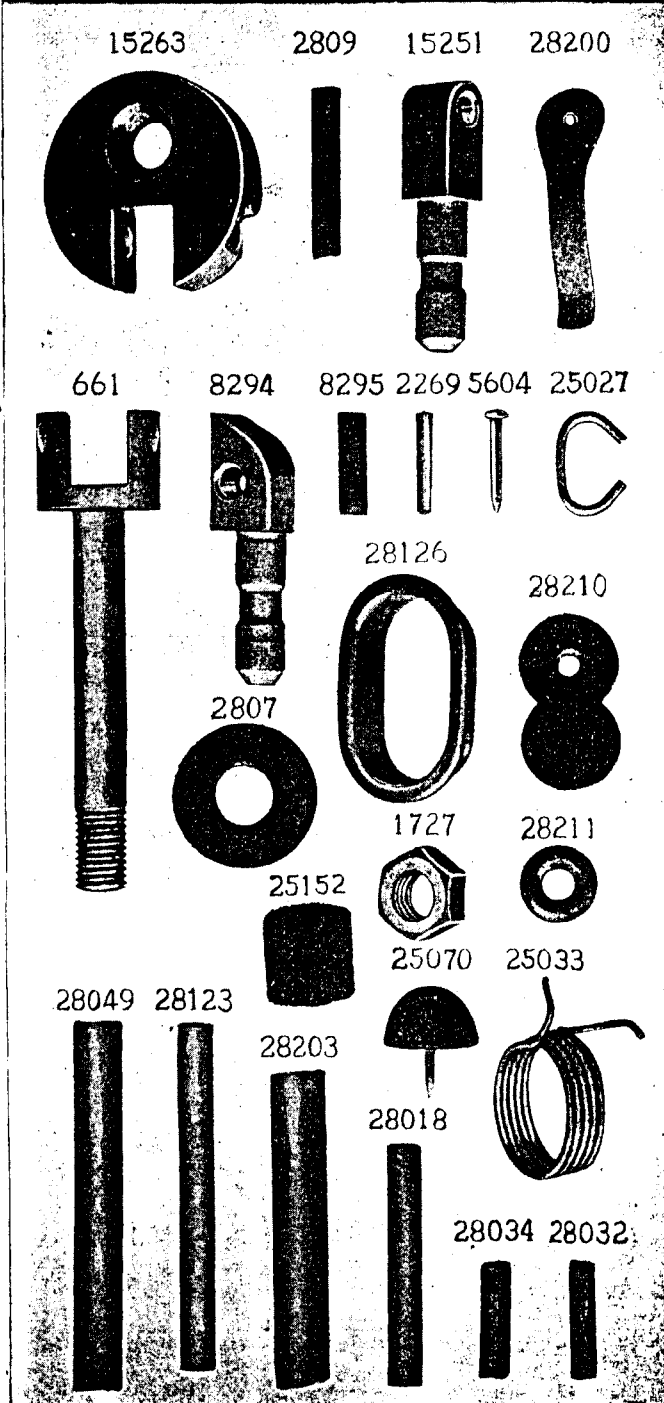


PLATE 2909—FULL SIZE

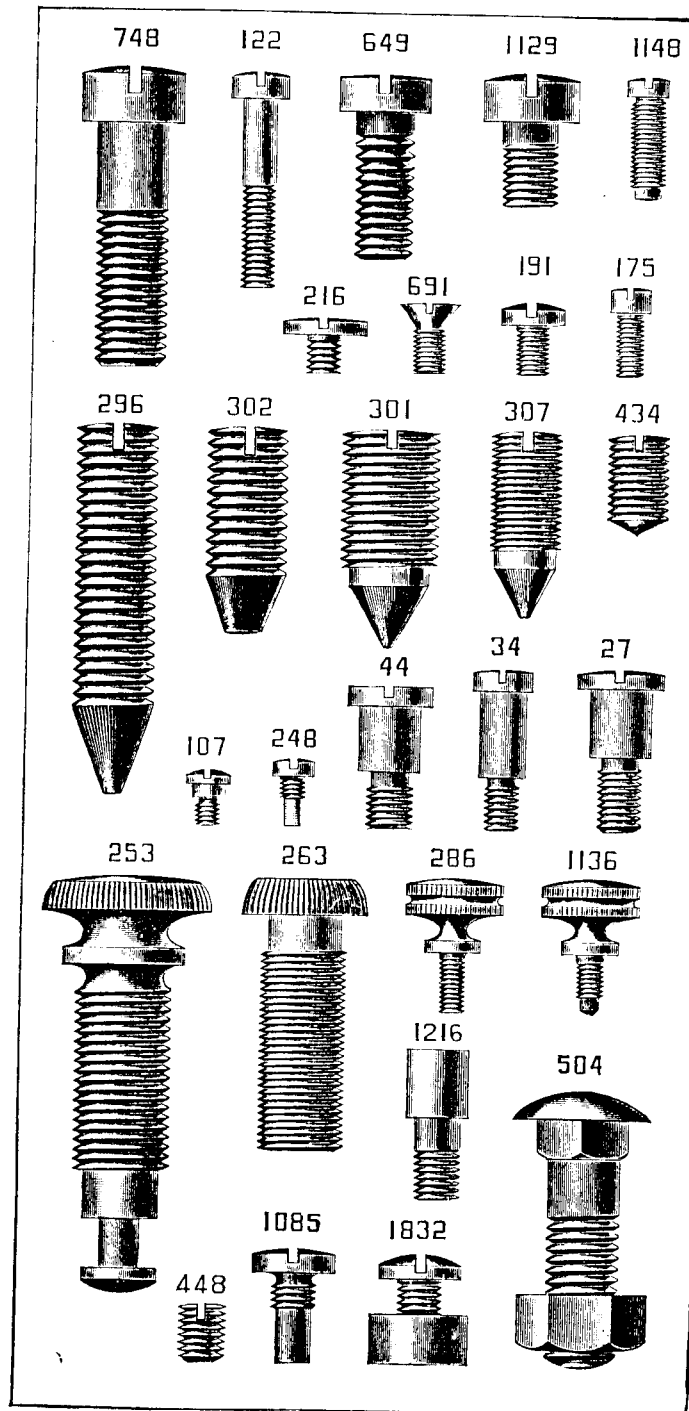




PLATE 2910—FULL SIZE

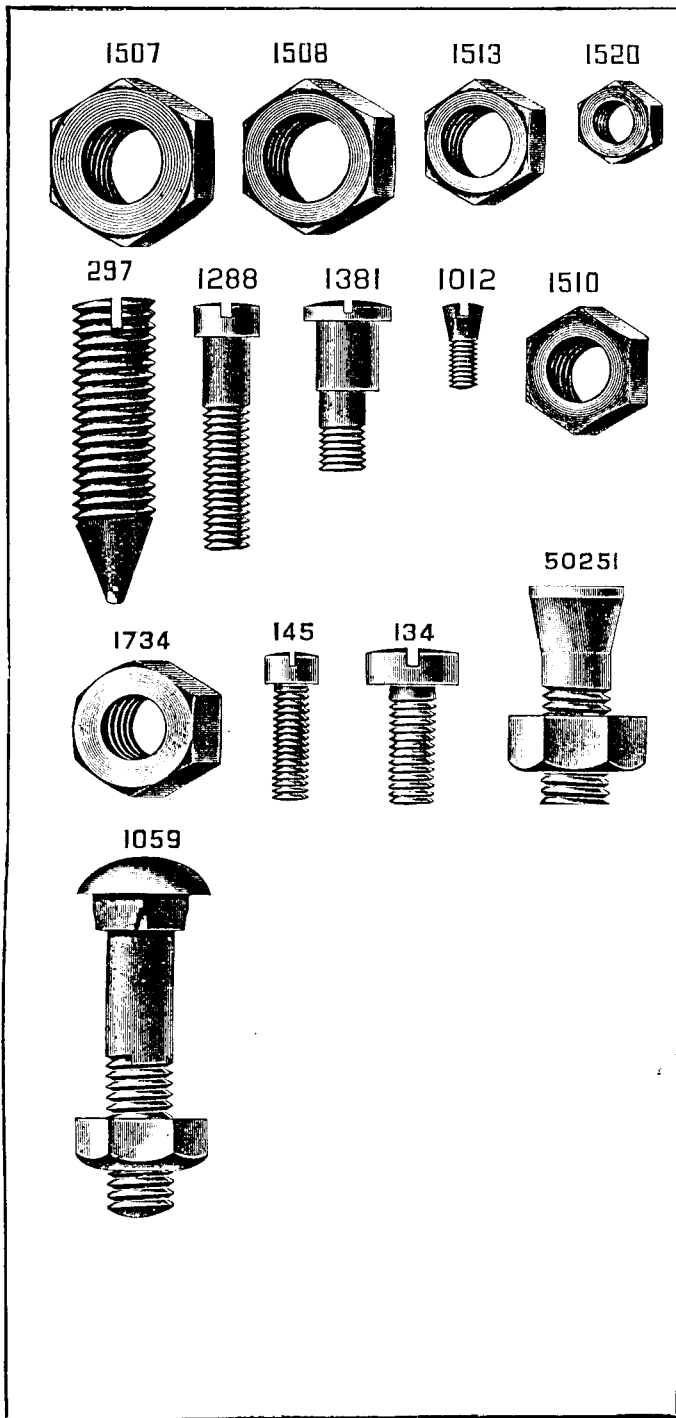


PLATE 2911—FULL SIZE

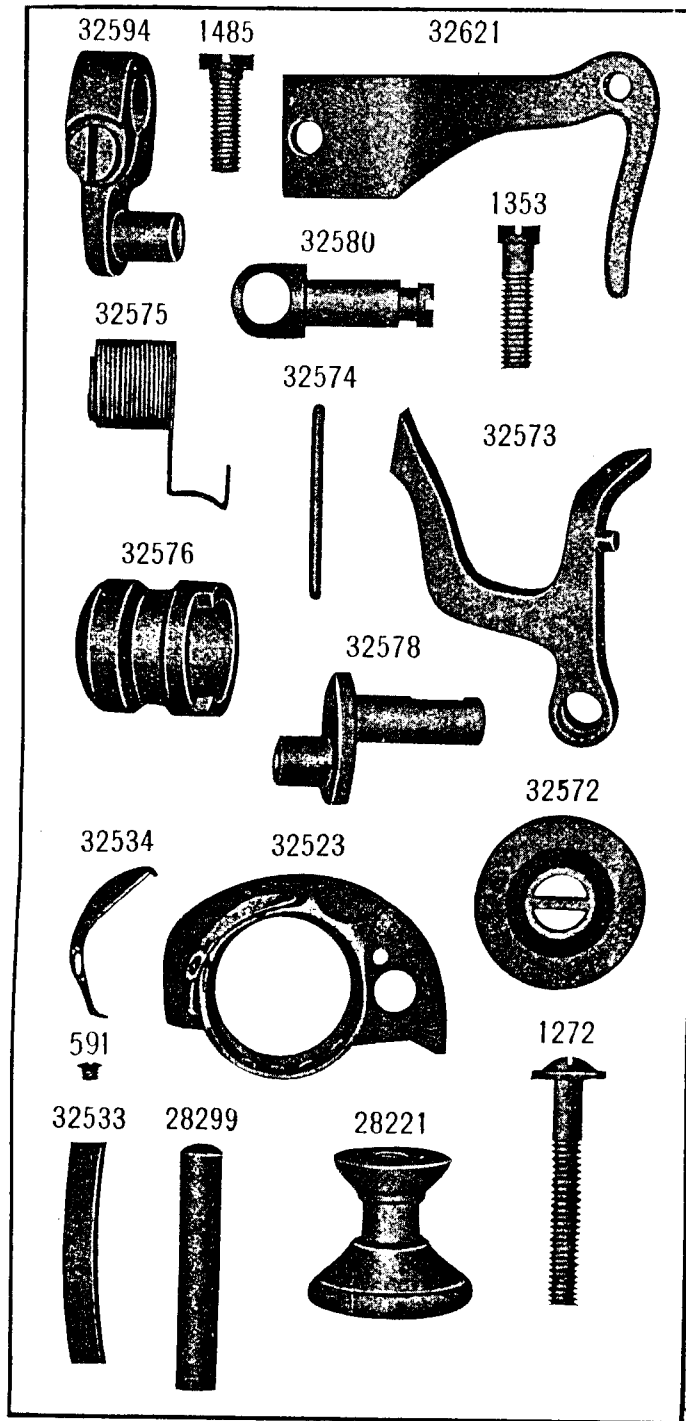


PLATE 2912—ONE-HALF SIZE

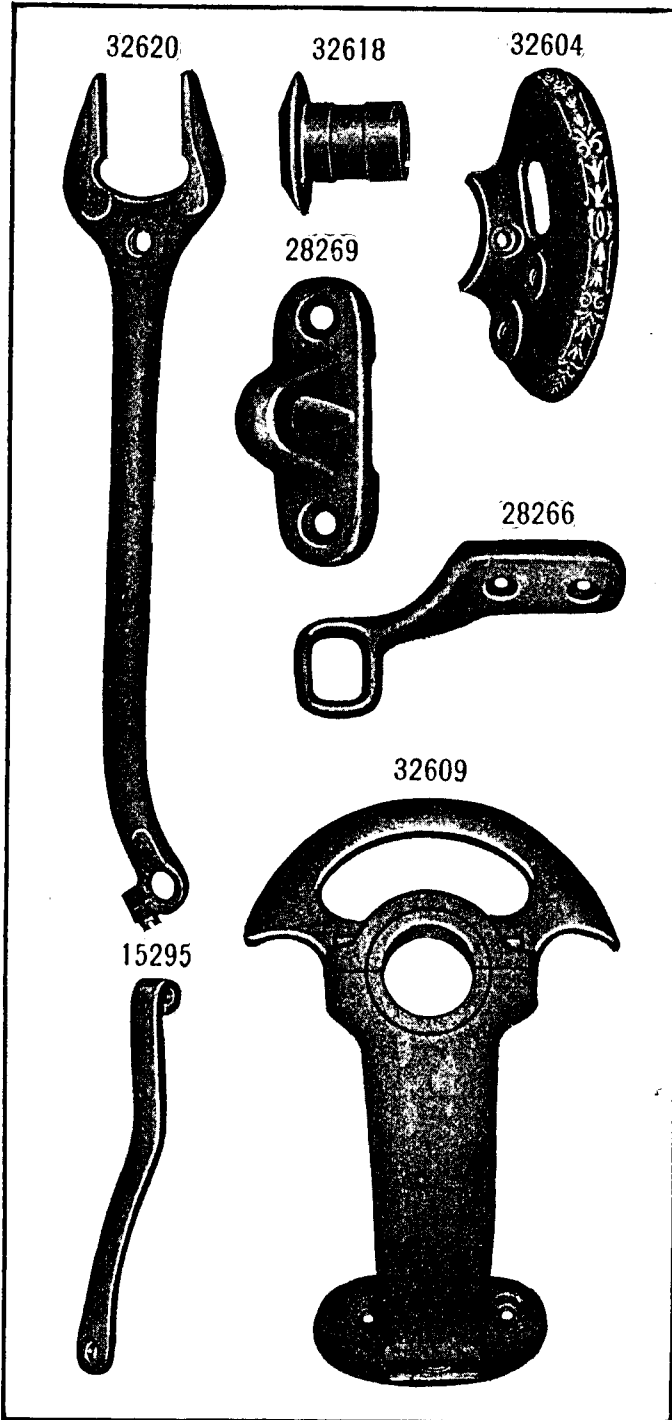


PLATE 2913—ONE-HALF SIZE

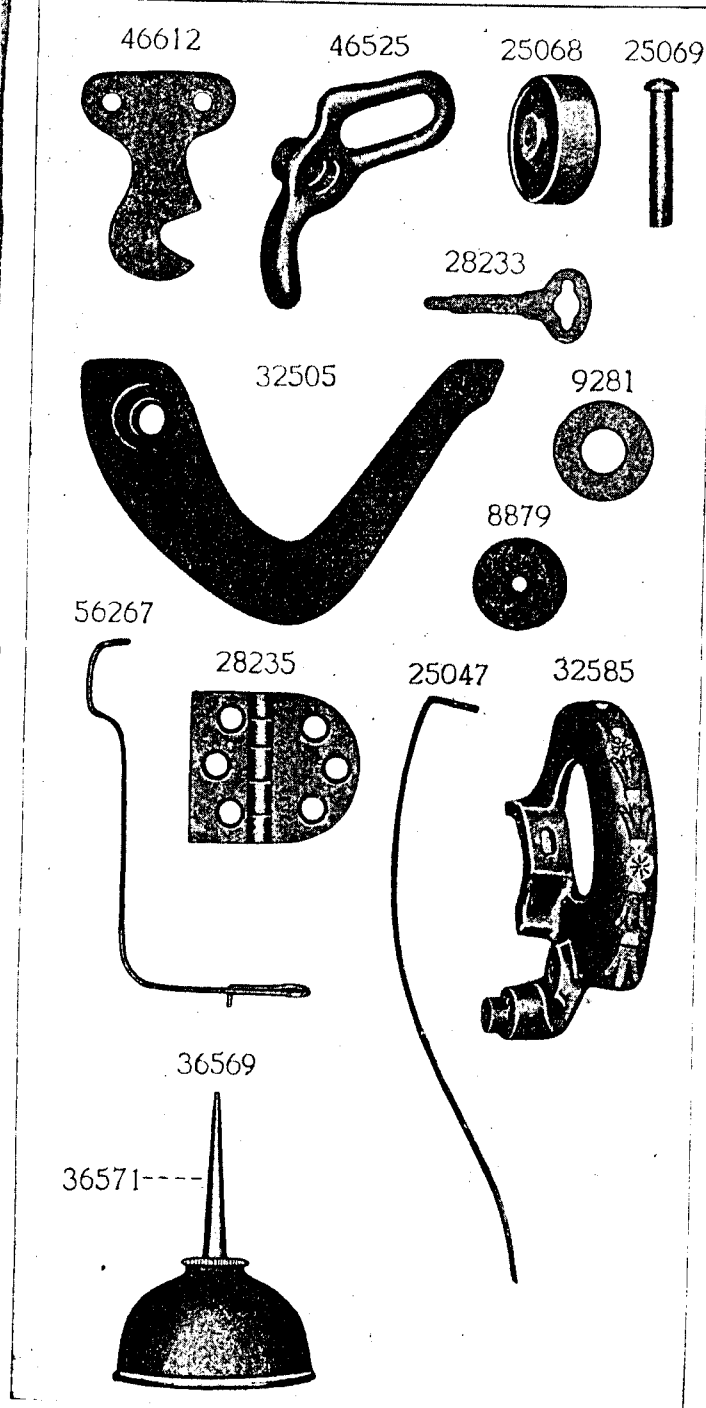


PLATE 2915—ONE-NINTH SIZE

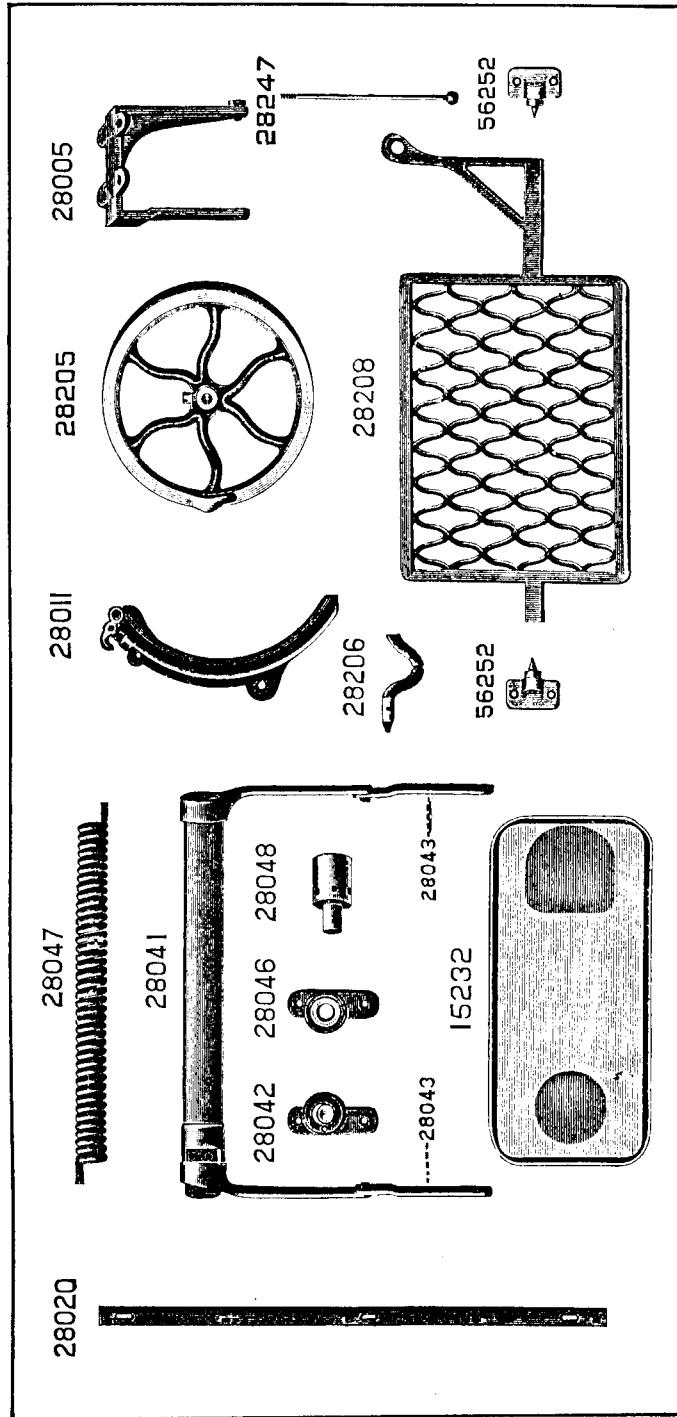


PLATE 2916—FULL SIZE

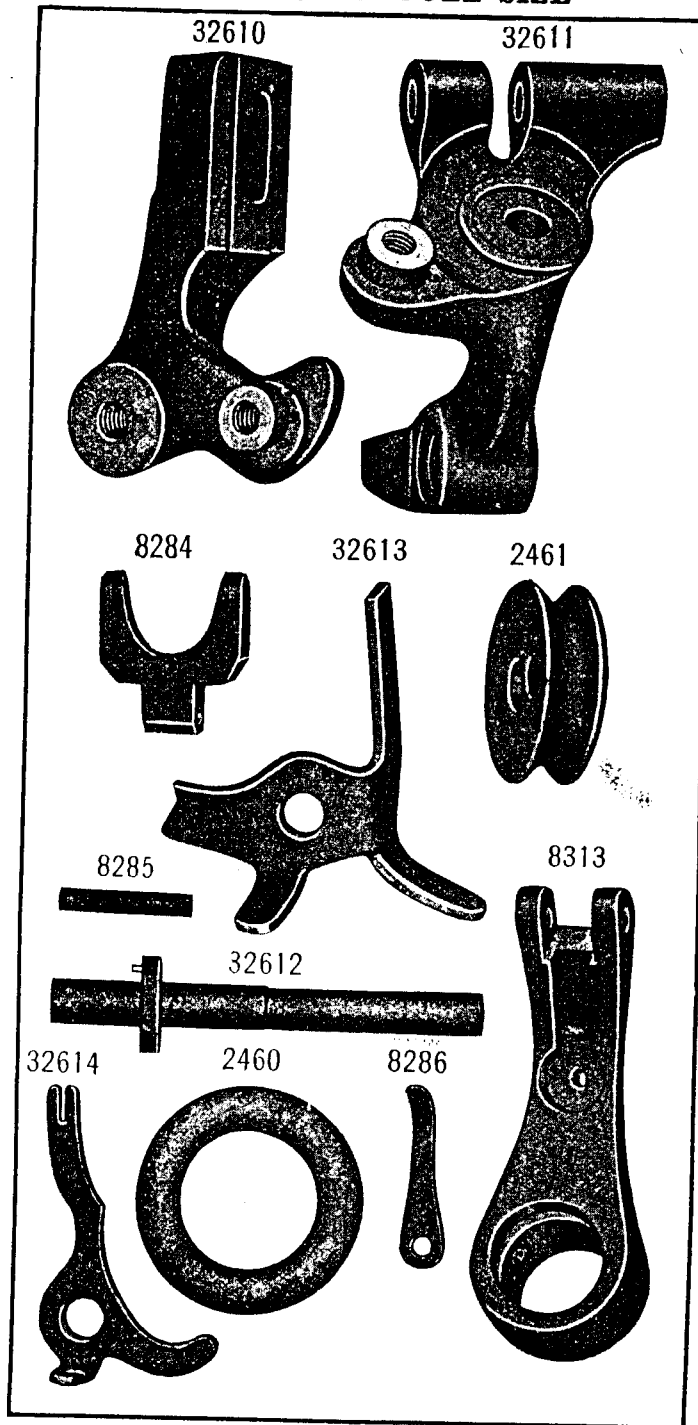


PLATE 2917—FULL SIZE

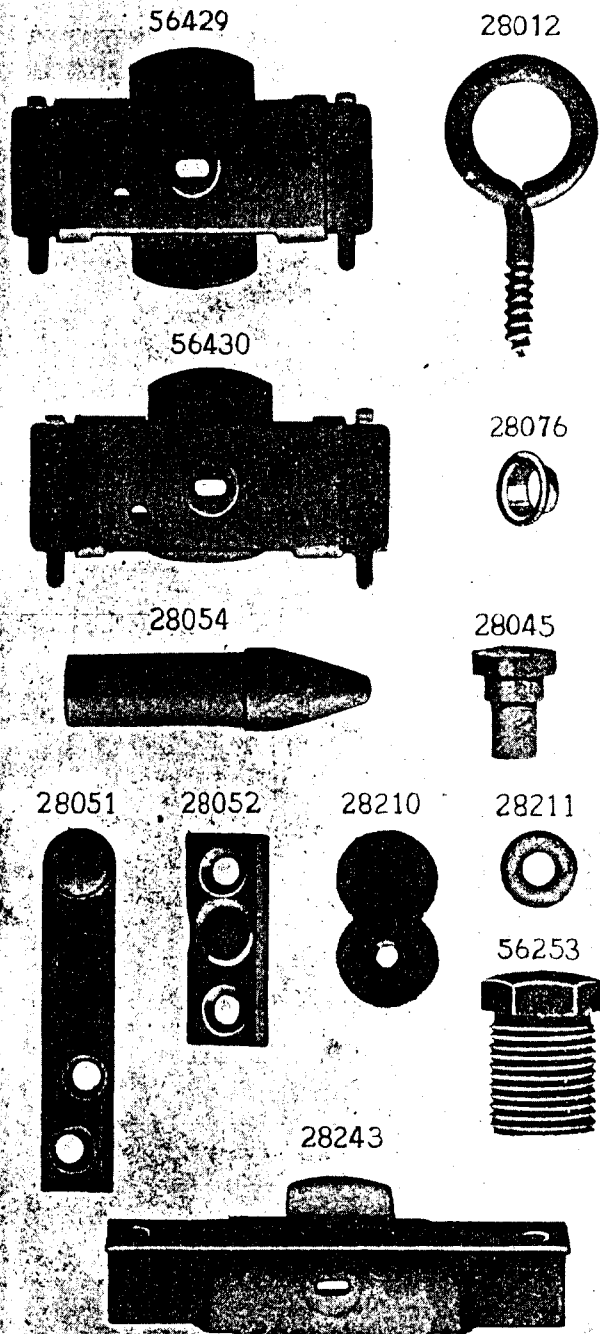


PLATE 2918—FULL SIZE

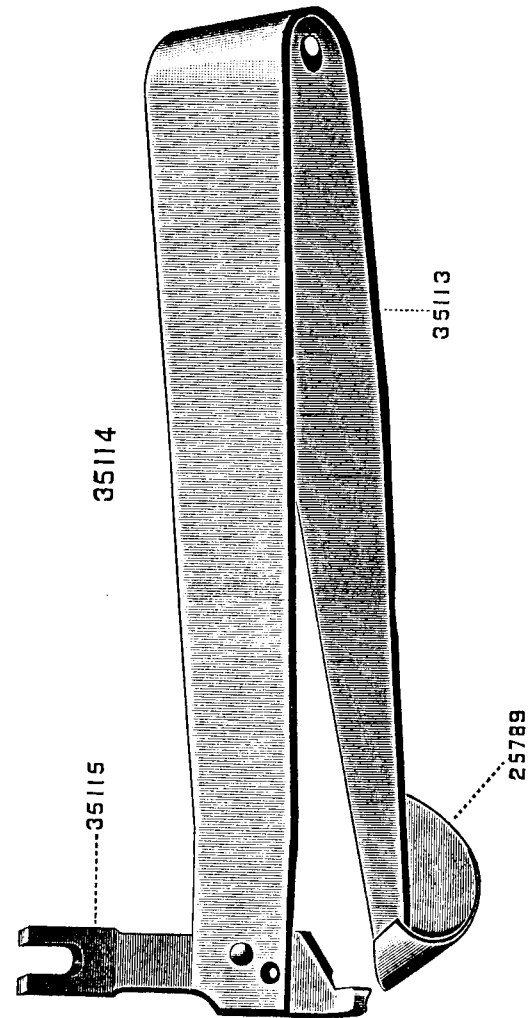
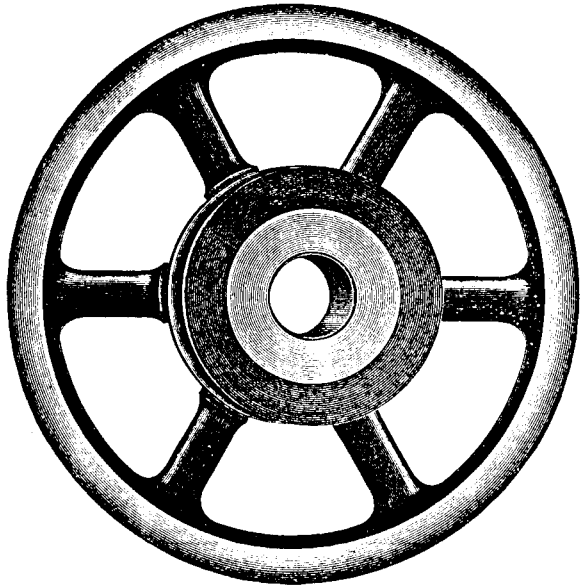


PLATE 2919—ONE-HALF SIZE

32584



2008

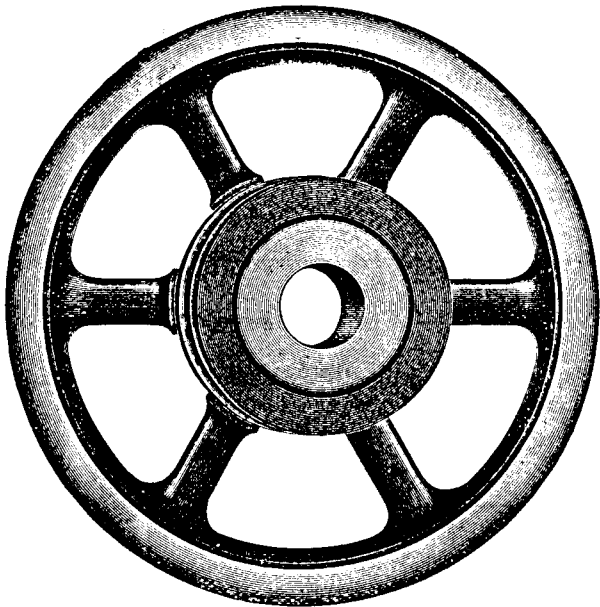


PLATE 2920—HALF SIZE

32577



32581



32617

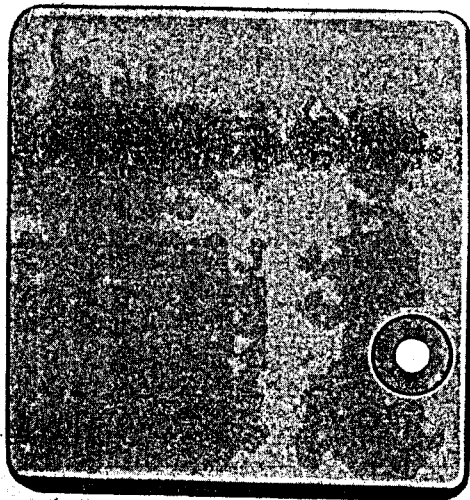


32615



PLATE 2921—FULL SIZE

32582



1423



32583



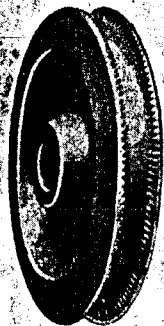
21360



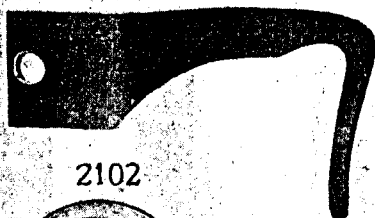
8422



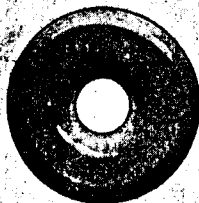
32586



32579



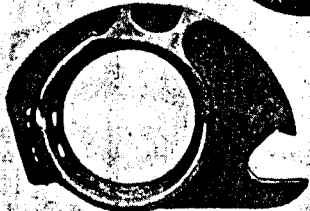
2102



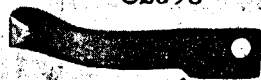
26075



32590



32593



32591



32598

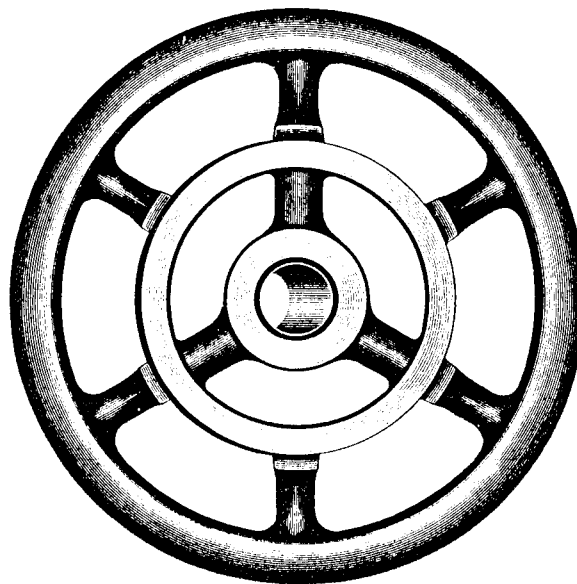


32599



PLATE 2922—ONE HALF SIZE

32588



15282

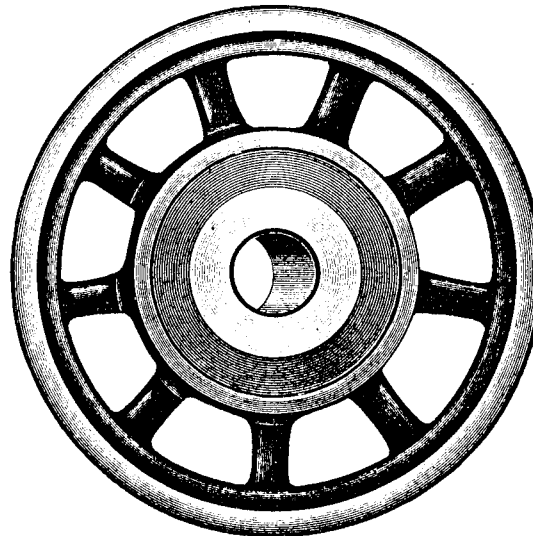


PLATE 2923—FULL SIZE

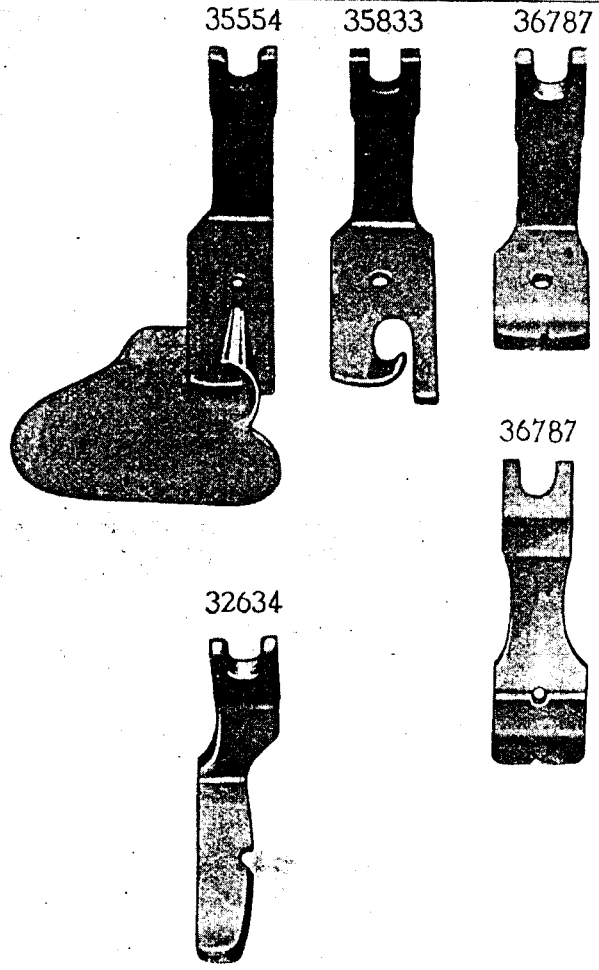


PLATE 2924—FULL SIZE

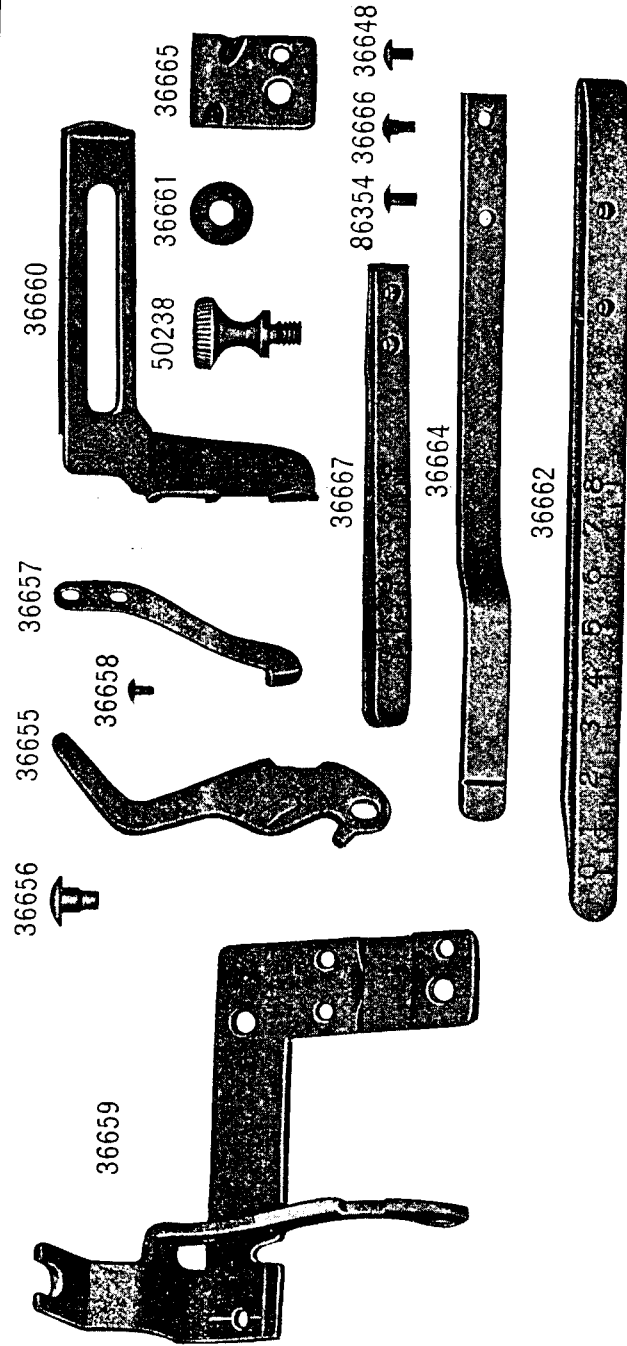


PLATE 2925—FULL SIZE

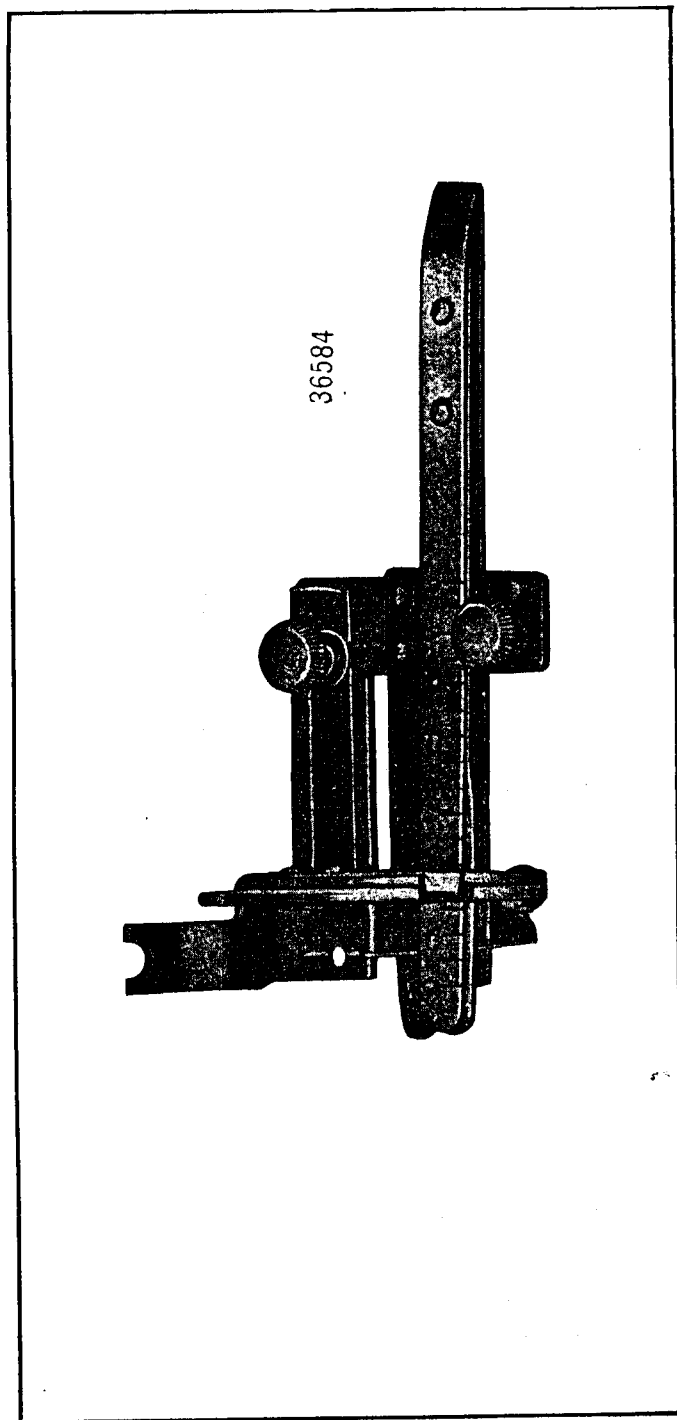


PLATE 2926—FULL SIZE

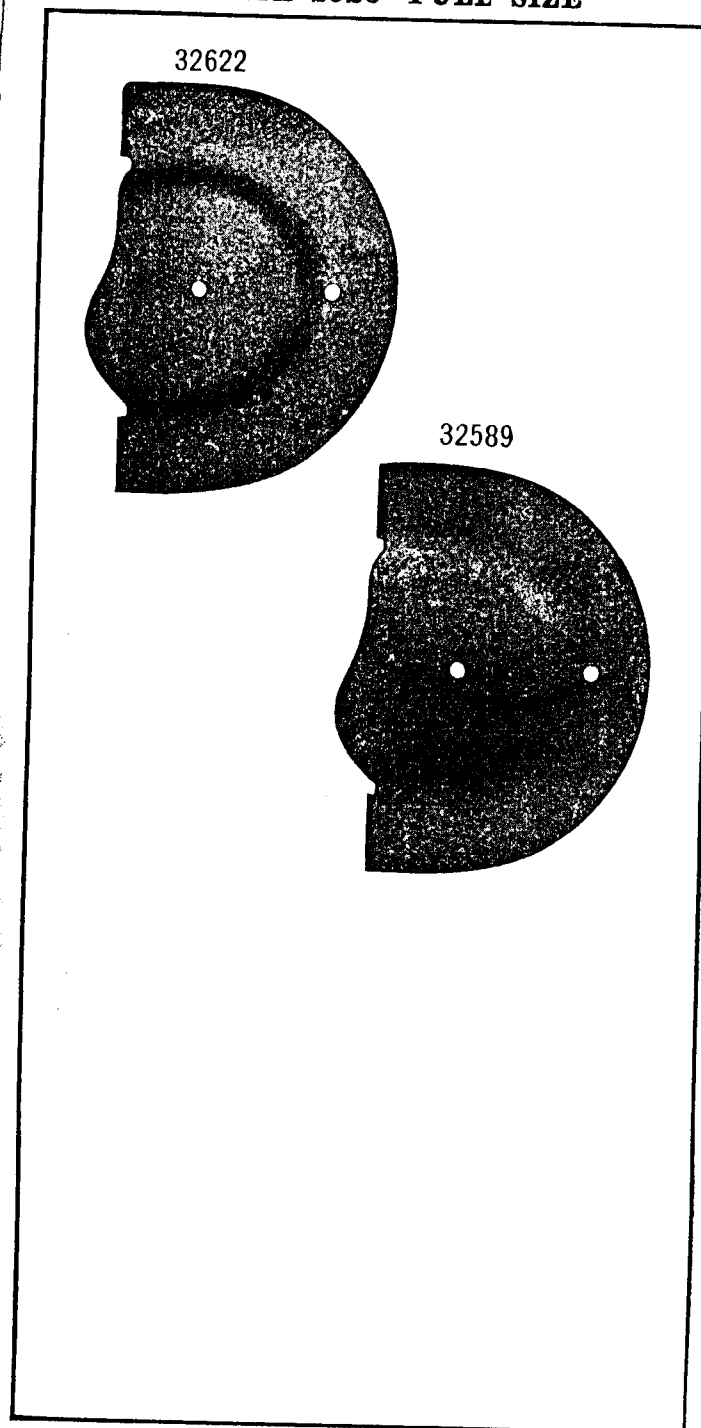
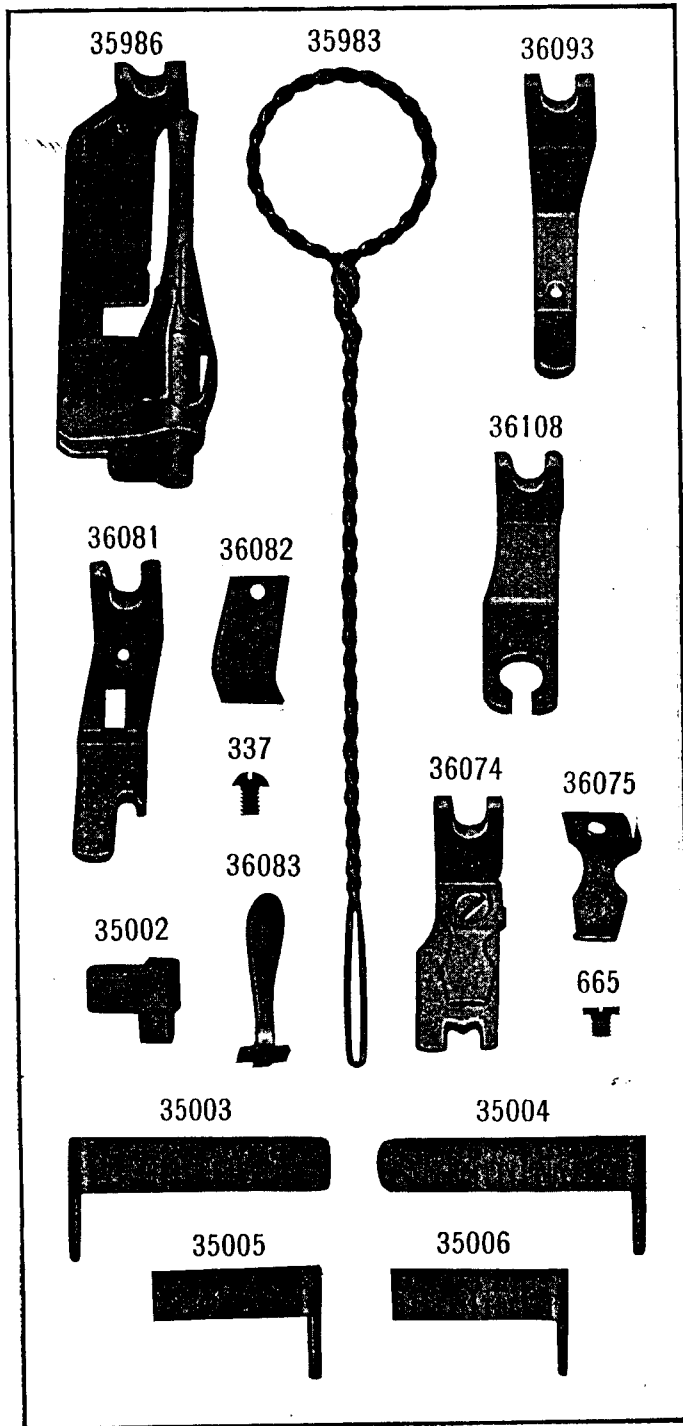




PLATE 2927—FULL SIZE



2928—ONE-HALF SIZE

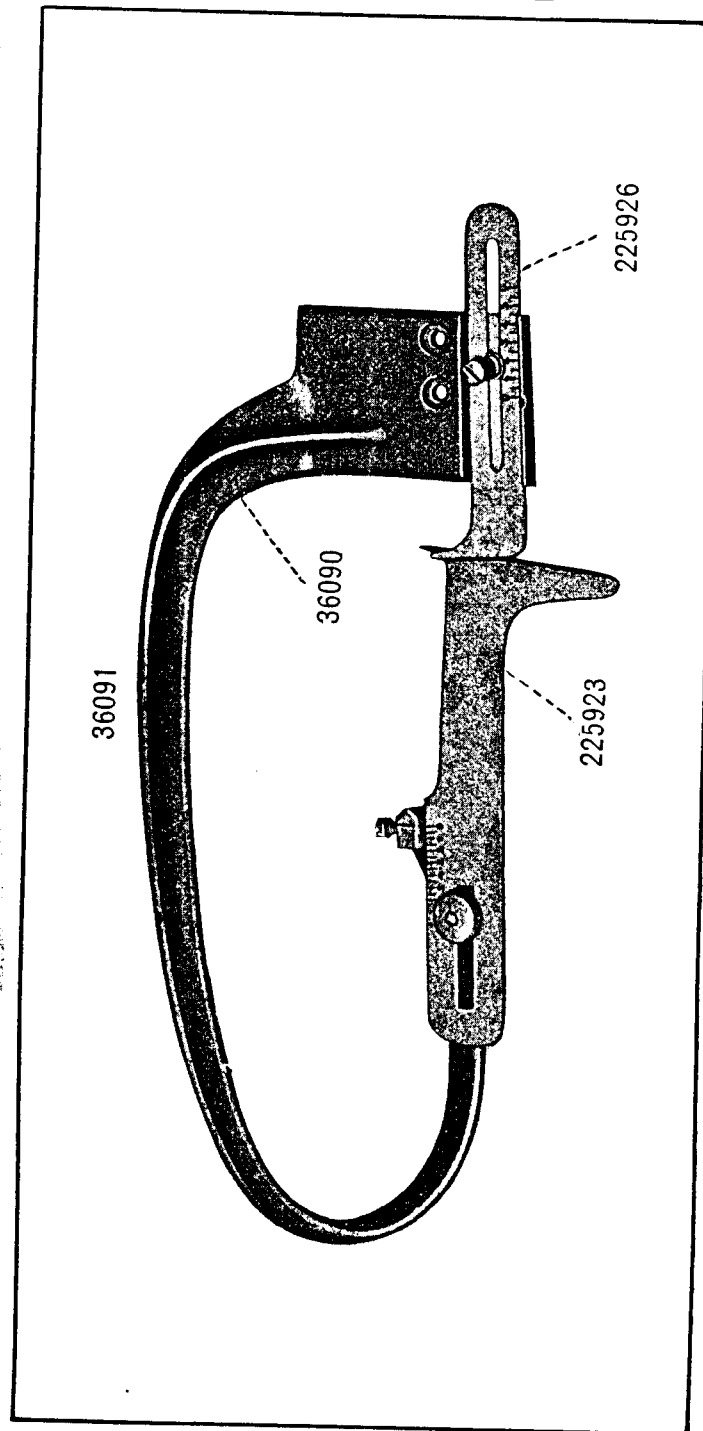
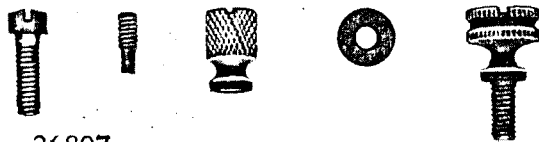


PLATE 2929—FULL SIZE

50066 19044 50067 202600 1704



171 50068 1705 202603 1483



36807



PLATE 2930—ONE-HALF SIZE

87555



PLATE 3826—FULL SIZE

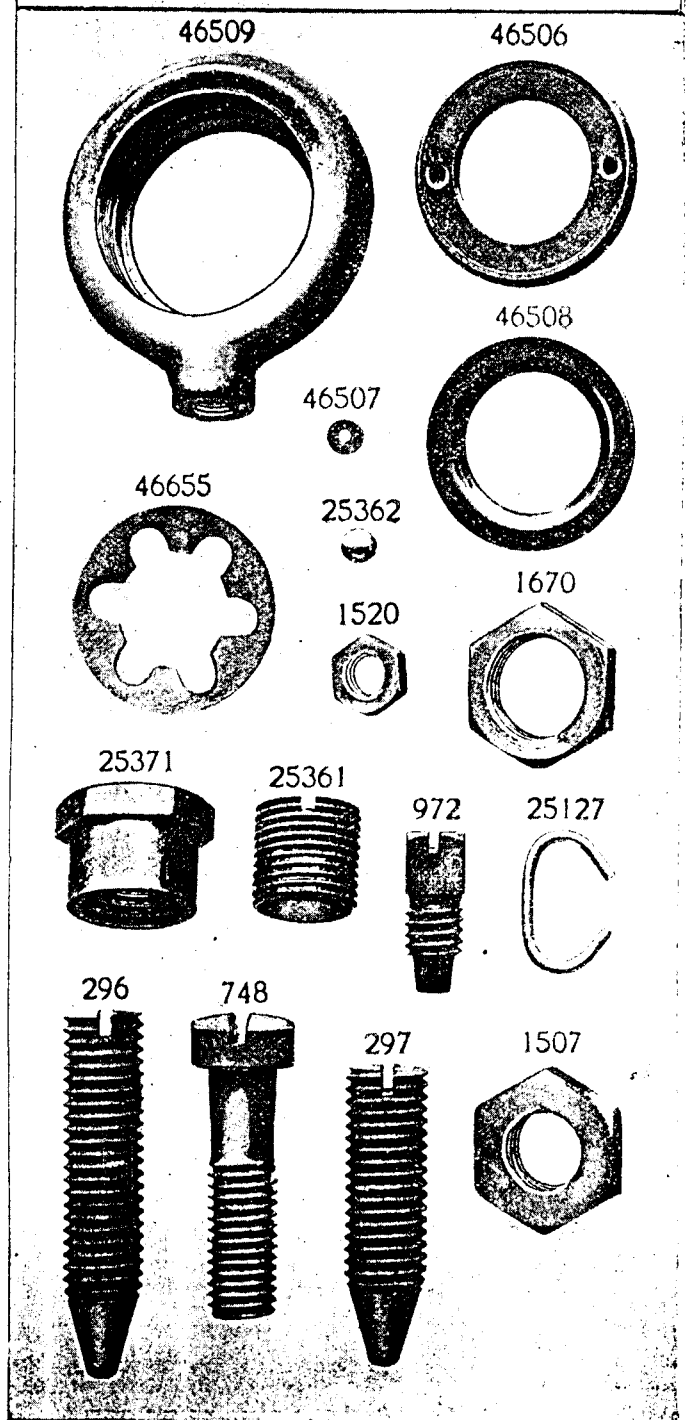


PLATE 4270—FULL SIZE

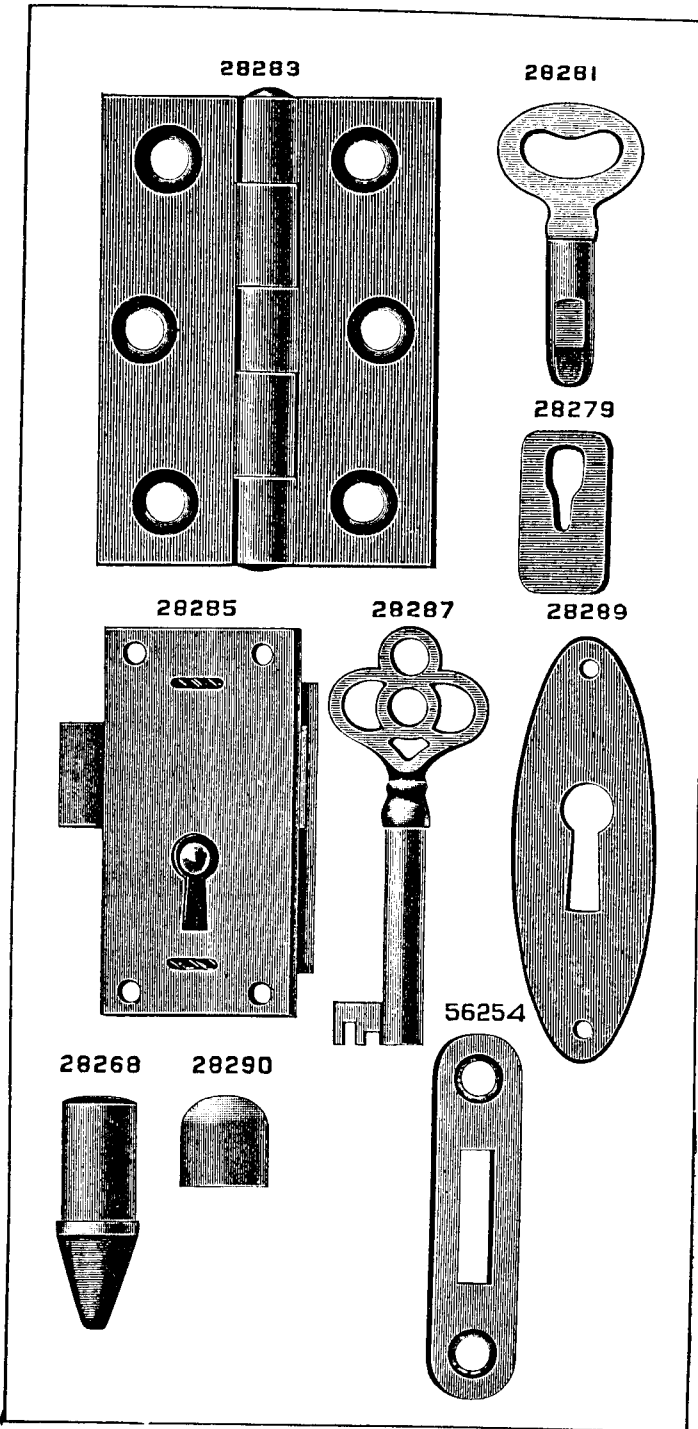


PLATE 4915—ONE-HALF SIZE

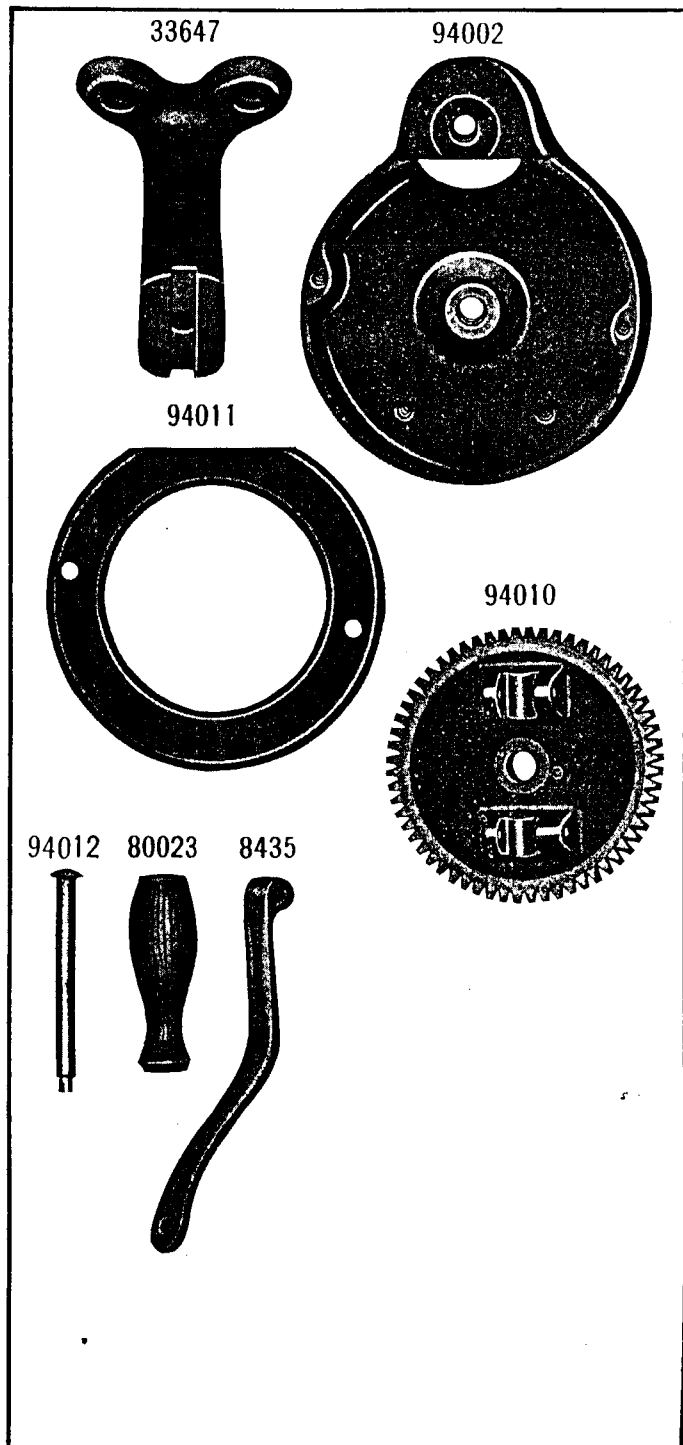


PLATE 4916—FULL SIZE

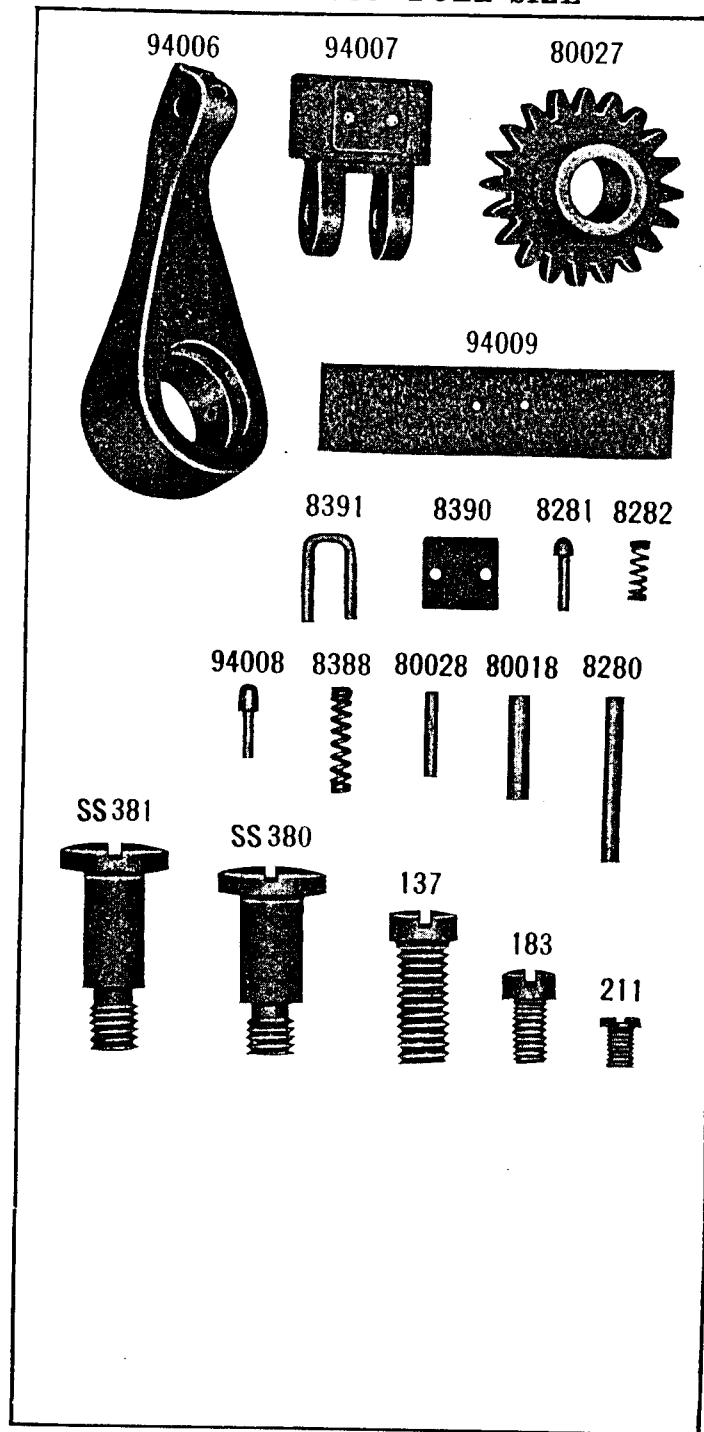


PLATE 5635—FULL SIZE

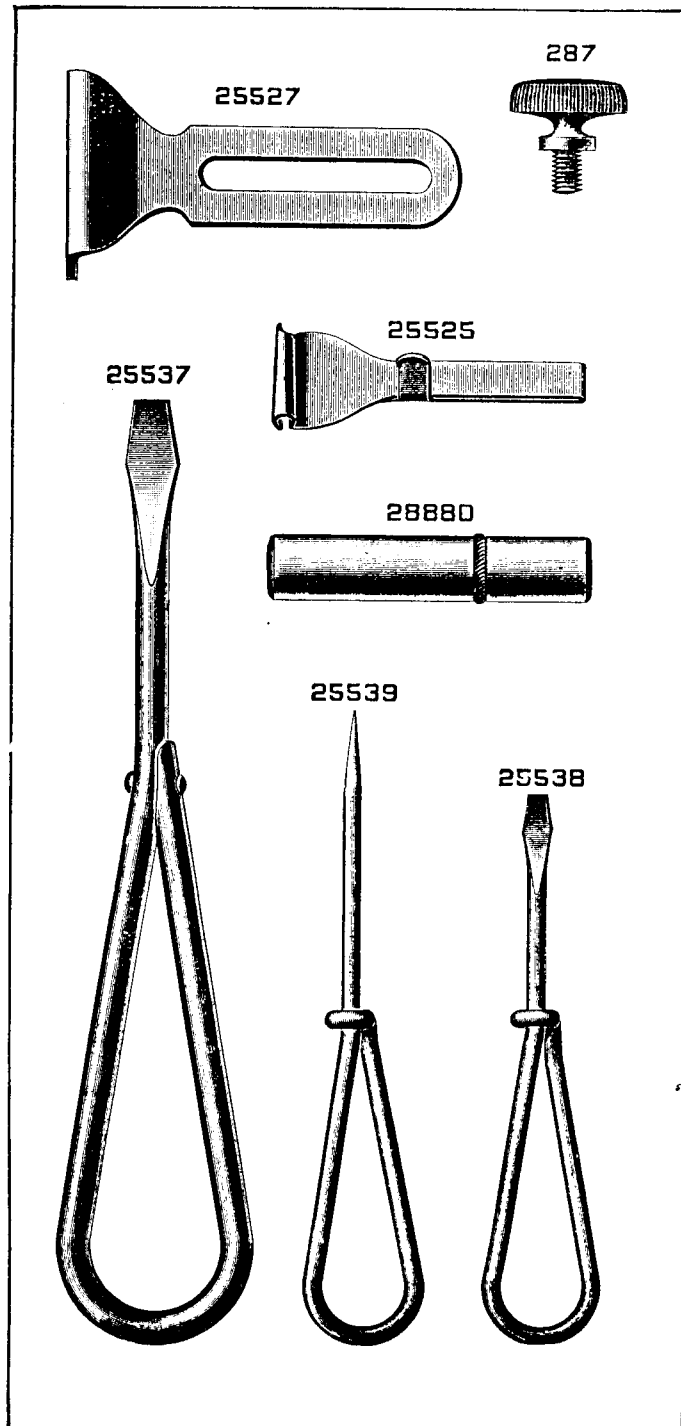


PLATE 5640—FULL SIZE

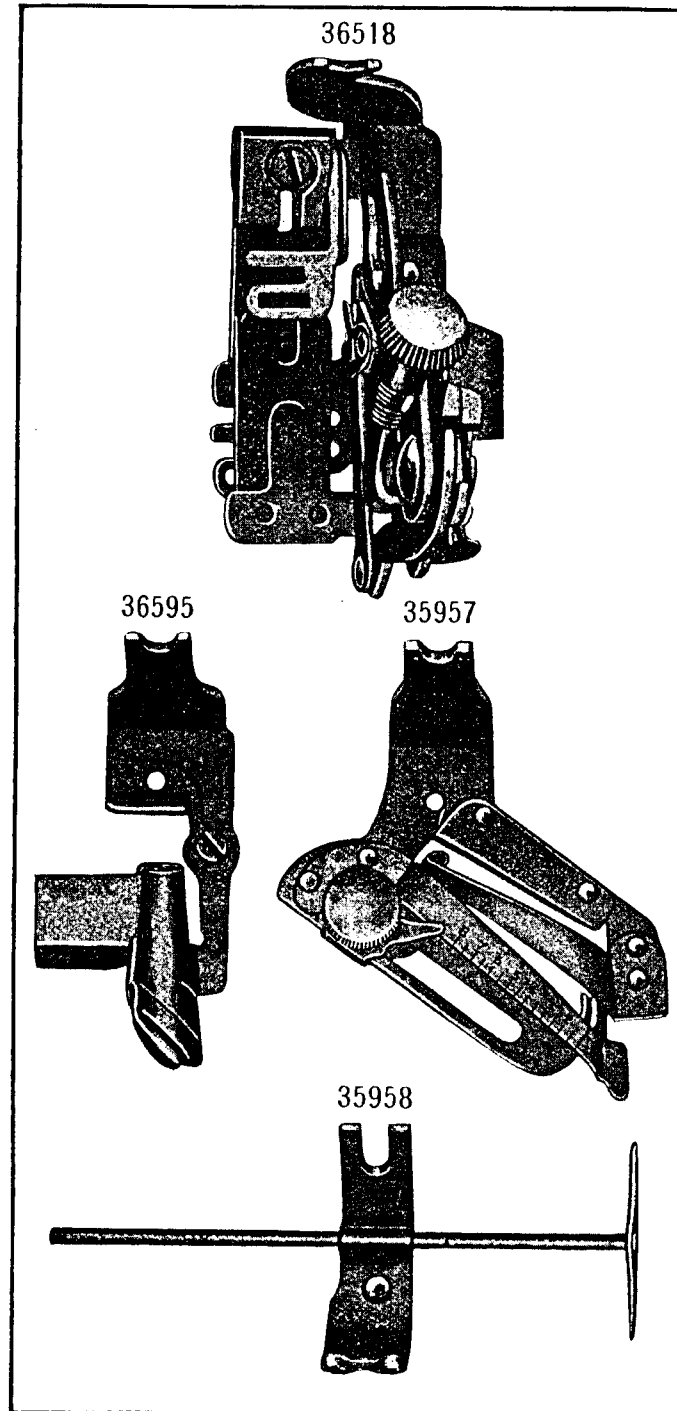
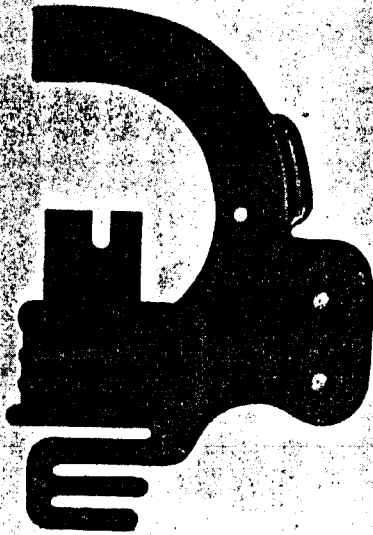
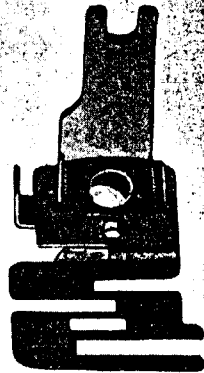


PLATE 5642—FULL SIZE

35960



36867

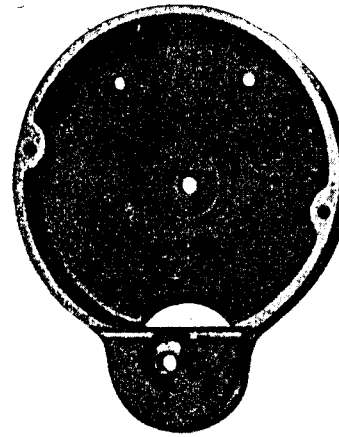


35963

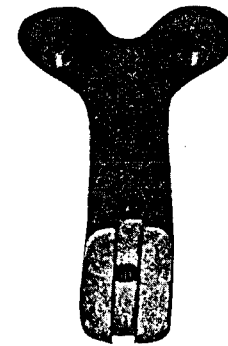


PLATE 6309—ONE-HALF SIZE

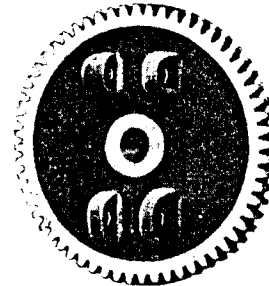
8377



33647



8392



8434



8380



8435



8393

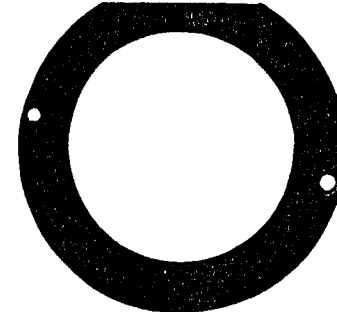


PLATE 6310—FULL SIZE

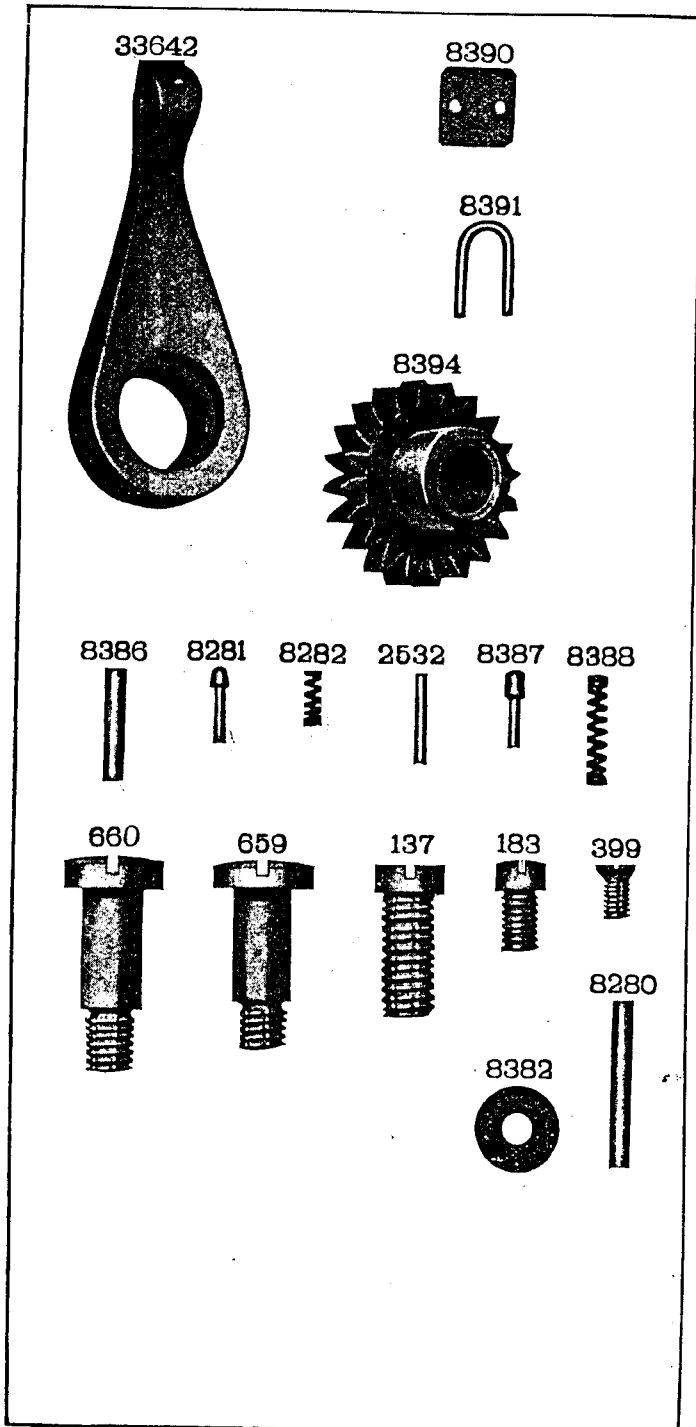


PLATE 6313—FULL SIZE

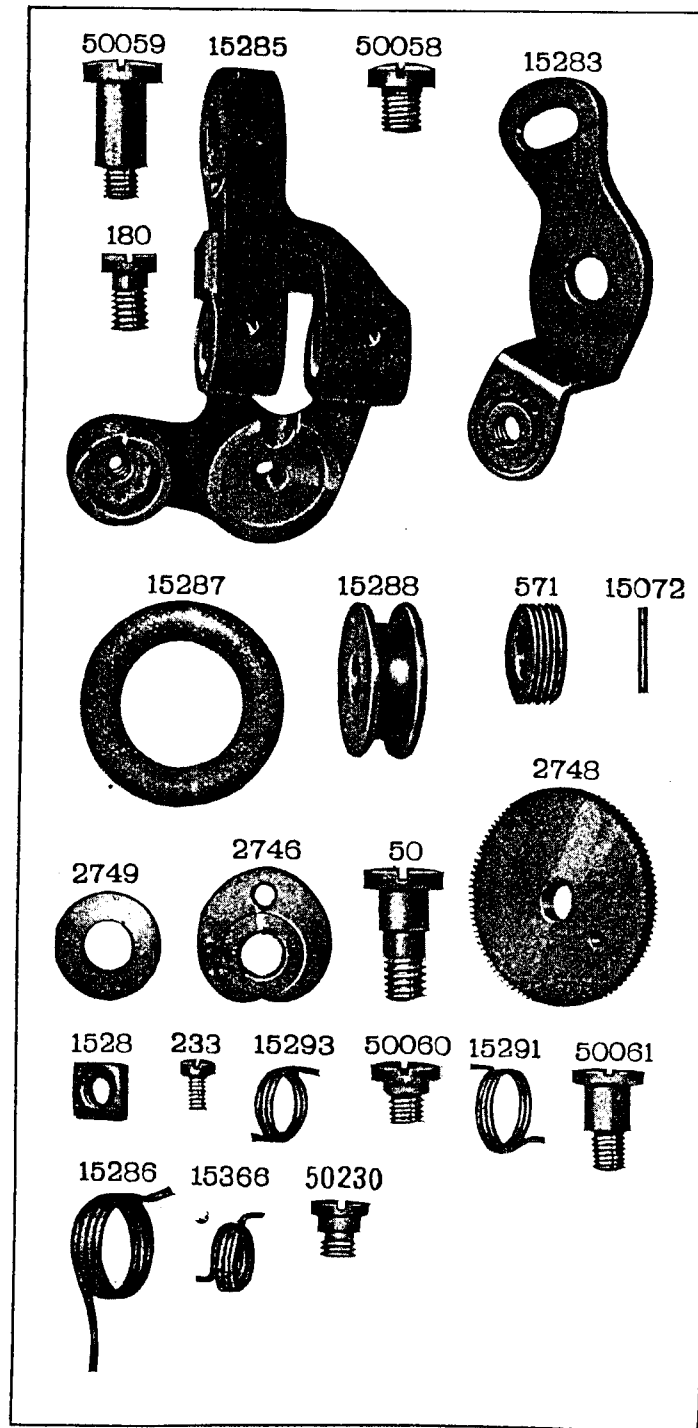


PLATE 6314—FULL SIZE

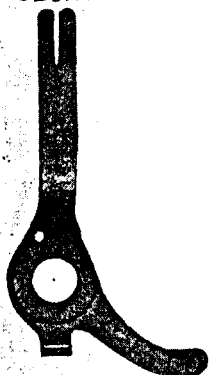
32607



32606



32623



32625



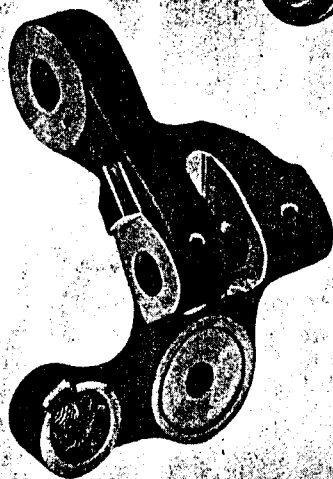
15376



32628



15413



15414



15424



15416

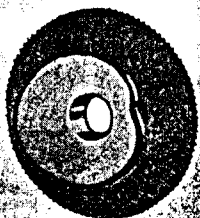
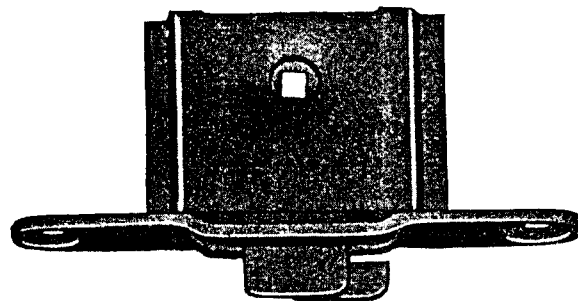
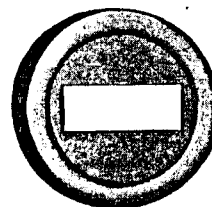


PLATE 6316—FULL SIZE

56251



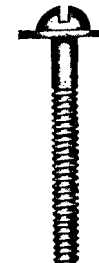
28297



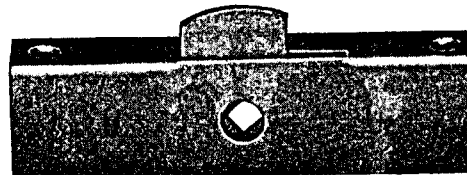
28221



1272



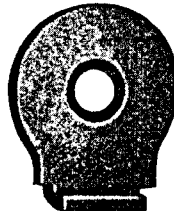
28243



28077



87428



87372

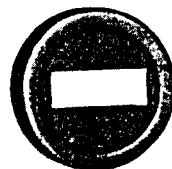




PLATE 6317—FULL SIZE

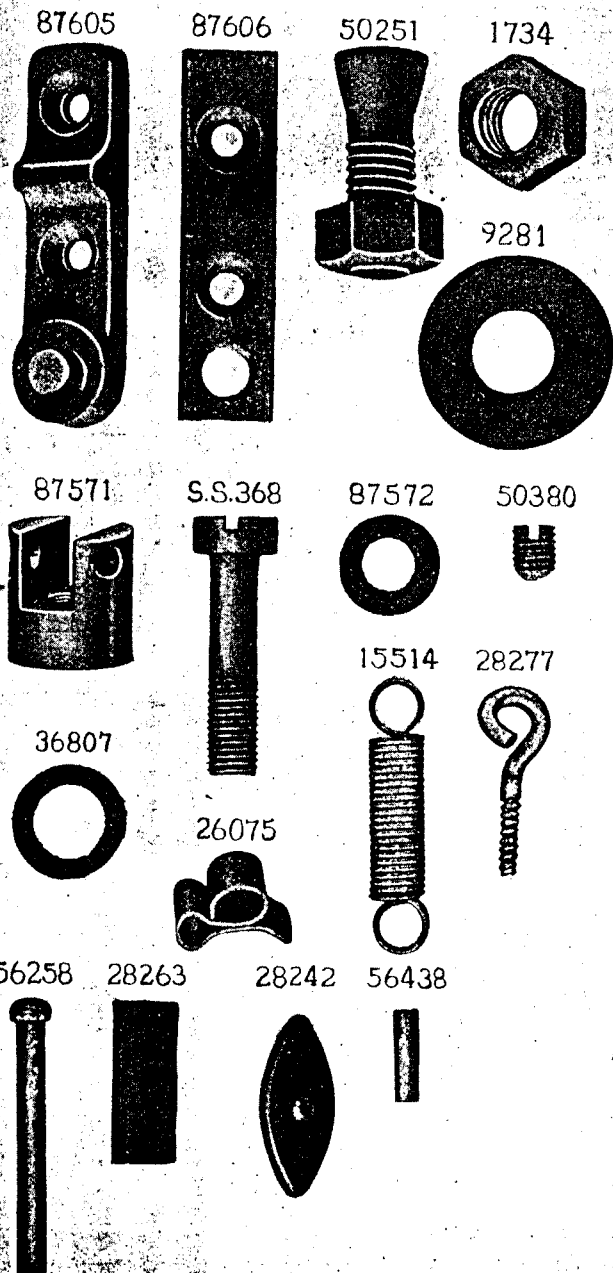


PLATE 6321—ONE-NINTH SIZE

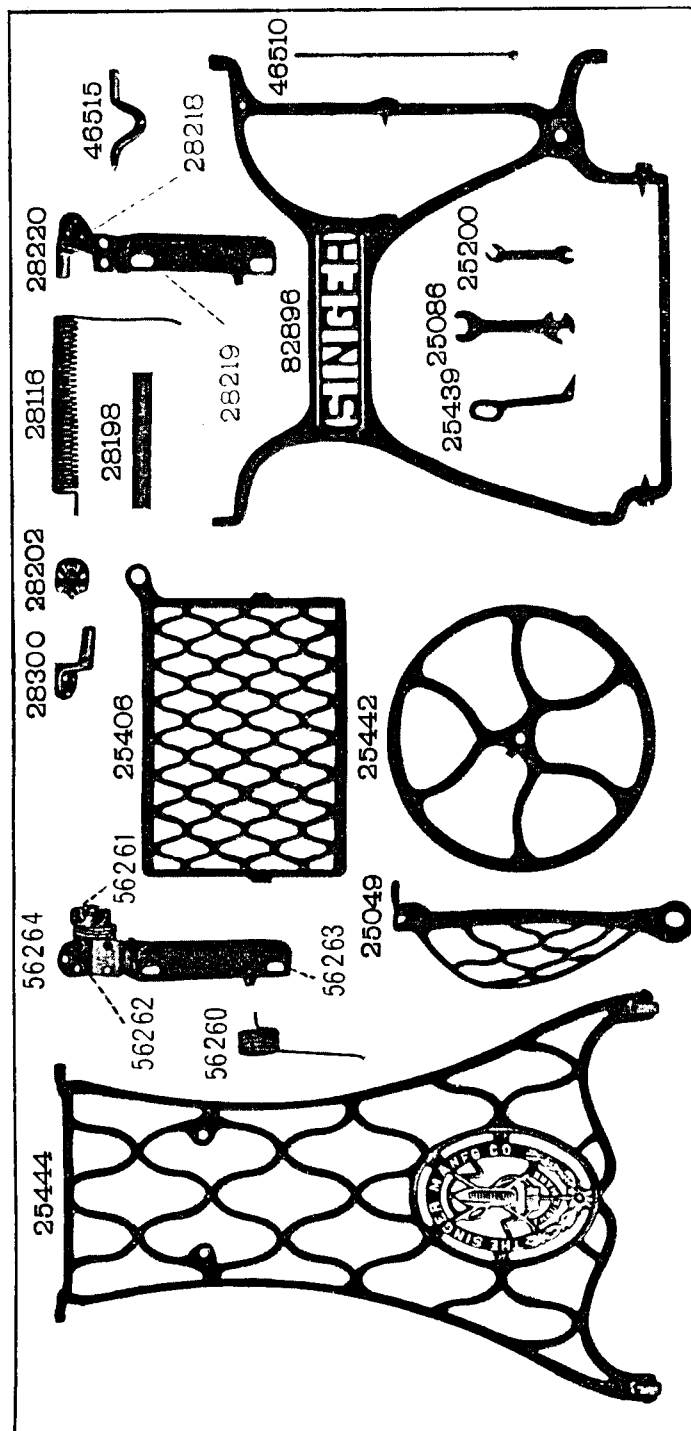


PLATE 6322 - ONE-NINTH SIZE

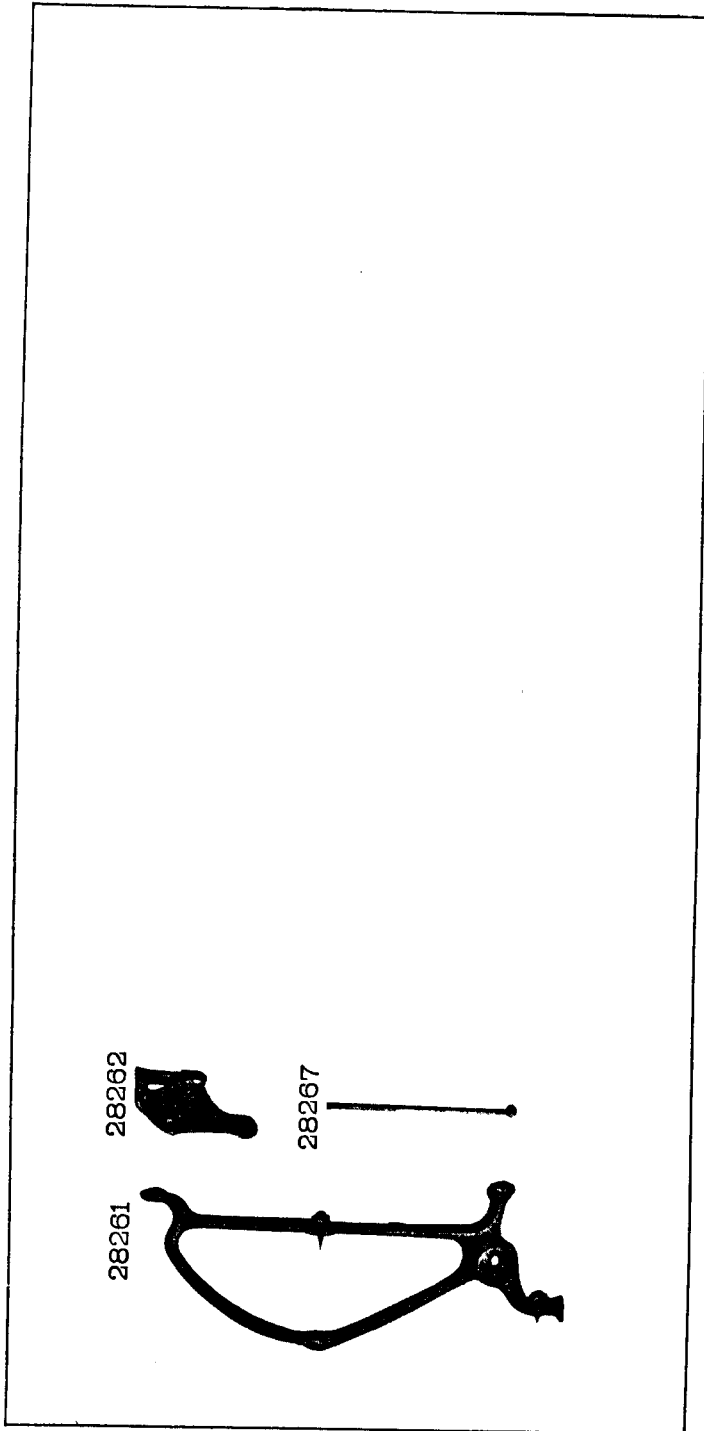


PLATE 6413 - FULL SIZE

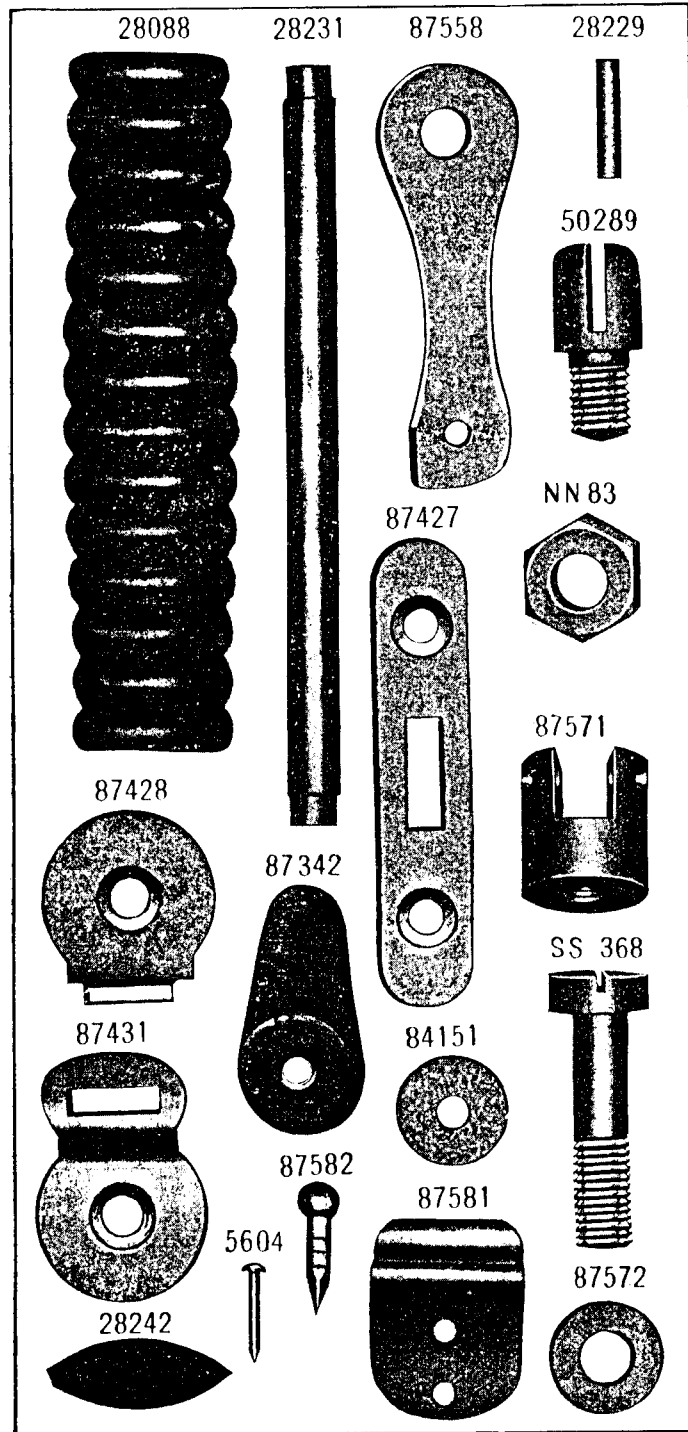
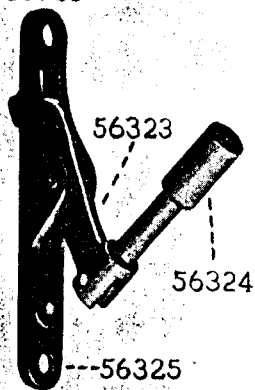


PLATE 6429--ONE-HALF SIZE

56326



56323

56324

---56325