

Singer 69-5
Singer 69-6
Singer 69-7
Singer 69-8
Singer 69-9
Singer 69-10
Singer 69-11
Singer 69-12
Singer 69-13
Singer 69-14
Singer 69-15
Singer 69-16
Singer 69-17
Singer 69-18
Singer 69-19
Singer 69-25

FORM 8797
SUPERSEDES FORM 8047
FEBRUARY, 1922

LIST
OF
PARTS



MACHINES
Nos. 69-5 to 69-19
and 69-25

THE SINGER MANUFACTURING COMPANY

COPYRIGHT, U. S. A.,
1915, 1916, 1917 AND 1922,
BY
THE SINGER MANUFACTURING COMPANY
ALL RIGHTS RESERVED FOR ALL COUNTRIES

INDEX

	PAGE
ATTACHMENTS AND ACCESSORIES.....	59
BOBBIN WINDERS.....	59
CLAMPS.....	56
MACHINE No. 69-5.....	7
“ “ 69-6.....	19
“ “ 69-7.....	19
“ “ 69-8.....	21
“ “ 69-9.....	23
“ “ 69-10.....	24
“ “ 69-11.....	25
“ “ 69-12.....	27
“ “ 69-13.....	28
“ “ 69-14.....	30
“ “ 69-15.....	32
“ “ 69-16.....	33
“ “ 69-17.....	35
“ “ 69-18.....	36
“ “ 69-19.....	37
“ “ 69-25.....	46
NUMERICAL LIST OF PARTS.....	71
OBSOLETE PARTS.....	66
PROTECTOR.....	62
STAND FOR ELECTRIC MOTOR.....	62
STARTING LEVER AND FOOT LIFTER PARTS.....	63
TABLE BELT GUIDES.....	64
THREAD UNWINDER.....	65

INSTRUCTIONS FOR ORDERING

In ordering from this list, use **ONLY** the PART number in the **FIRST** column.

The number stamped on a Sewing Machine part is in every case the number of the single part only.

Every combination of parts sent out as such has its specific number, which, although not stamped on the parts, must be used when ordering the combination.

Each number always indicates the **SAME PART** in whatever list it appears, or for whatever machine.

The letters after some of the numbers indicate the style of finish only, as follows:

- A. Hardened, Polished and Plated.
- B. Polished and Plated.
- C. Hardened only.
- D. Polished only.
- E. Soft, not Polished.
- F. Hardened and Polished.
- G.
- H. Blued.
- J. Plated only.
- K. Hardened and Plated.
- L. Brass or Gilt
- M. Oxidized.
- P. Japanned.
- R. Parkerized.

These letters **MUST BE USED** when they appear in the list, and **AFTER** the number as in the list.

In this series

1 to 1500 and 50001 to 51500 are Screw Numbers.

1501 to 1800 are Nut Numbers.

1801 to 2000 are Roller Numbers.

2001 to 50000 and 52001 and upward are numbers of Machine Parts.

The figures in the second column refer only to the plates illustrating the parts, and are **NOT TO BE USED** in ordering

Parts marked with an asterisk (*) are furnished only when repairs are made at factory.

LIST OF PARTS COMPLETE FOR

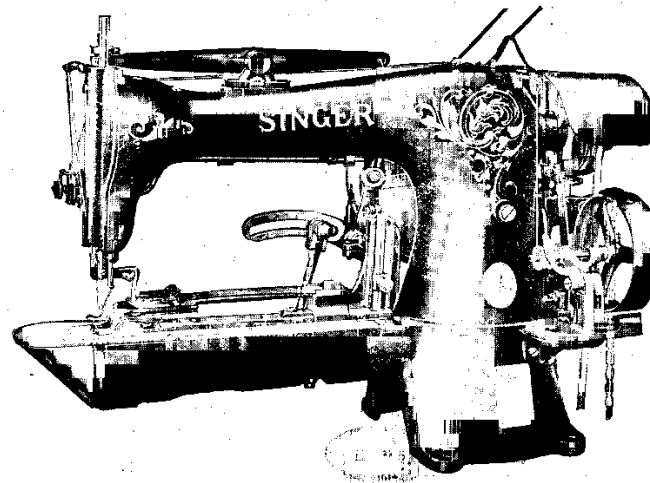

MACHINE No. 69-5

FOR SEWING FLAT BUTTONS UPON KNEE PANTS, COAT SLEEVES AND OTHER GARMENTS. MAKES CROSS STITCHES IN FOUR-HOLE BUTTONS AND CAN BE ADJUSTED FOR TWO-HOLE AND BAR BUTTONS. MAKES EIGHTEEN CROSS AND THREE TYING STITCHES.

NO.	PLATE	NAME
*18439	—	Arm with 4449, 17844 and two 164E.....
4389	5042	" Dowel Pin.....
4448	3722	" Oil Tube for intermediate bearing..
880E	3724	" Screw.....
17702	5000	" Shaft.....
17703	5001	" " Bushing (back).....
50333c	5042	" " " " Adjusting Screw
1520E	3724	" " " " " " " "
		Nut.....
*4449	—	Arm Shaft Bushing (front).....

PARTS FOR MACHINE No. 69-5

NO.	PLATE	NAME
18498	5033	Belt Cover.....
39290	5001	" " Bracket with 184E and 17741
184E	5021	" " " Screw Stud.....
17741	5008	" " " Stud.....
217D	3731	" " Screw.....
39222	5001	" Shifter.....
39223	5008	" " Clamp.....
1255D	5021	" " " Screw.....
17706	3704	Button Clamp (left) with 17723, for 17898
17707	3704	" " (right) with 17723, for 17898
17899	3708	" " (left) with 17723, for 17904
17900	3708	" " (right) with 17723, for 17904
39238	3747	" " (left) with 9311 and 17723, for 63928.....
39239	3747	Button Clamp (right) with 9311 and 17723, for 63928.....
17901	3704	Button Clamp Arm with 17711, 17714 and 23227, for 17898 and 17904.....
63927	7205	Button Clamp Arm with 17714 and 63788, for 63928.....
17710	3704	Button Clamp Arm Hinge Plate.....
1176J	3704	" " " " " Screw....
17711	3704	" " " " " Hook for 17901.....
63788	7205	" " " " " 63927.....
1175J	3704	" " " " " Hinge Screw.....
17708	3710	" " " " " Lifter with 17866.....
190D	3710	" " " " " Screw.....
17712	3710	" " " " " Pressure Spring for 17898 and 17904.....
39241	3748	Button Clamp Pressure Spring for 63928..
17713	3710	" " " " " Bracket....
1177D	3710	" " " " " " Screw
17714	3704	" " " " " Guide-Block
1178J	3710	" " " " " " Screw.....
17716	3705	" " " " " Spreader for 17898 and 17904
39242	3748	" " " " " 63928.....
17717	3705	" " " " " Lever.....
50237K	3705	" " " " " Hinge Screw
1180J	3705	" " " " " Locking Thumb Screw.....
17718	3705	Button Clamp Spreader Lever Locking Thumb Screw Washer.....
1182J	3705	Button Clamp Spreader Screw.....
17719	3705	" " " " " Spring.....
1181J	3705	" " " " " " Screw....
17720	3705	" " " " " Steady Pin.....

PARTS FOR MACHINE No. 69-5

NO.	PLATE	NAME
17721	3705	Button Clamp Spring, for flat buttons, for 17898.....
17938	3705	Button Clamp Spring, for stud back but- tons, for 17898.....
17902	3708	Button Clamp Spring, for flat buttons, for 17904.....
17939	3708	Button Clamp Spring, for stud back but- tons, for 17904.....
39244	3747	Button Clamp Spring (left) for flat buttons, for 63928.....
39245	3747	Button Clamp Spring (right) for flat but- tons, for 63928.....
39246	3748	Button Clamp Spring (left) for stud back buttons, for 63928.....
39247	3748	Button Clamp Spring (right) for stud back buttons, for 63928.....
39340	5027	Button Clamp Spring for 39341.....
39341	—	" " " 39340 with 39342, for flat or stud back buttons, for 17904
39342	5027	Button Clamp Spring Plate for 39341....
236J	3705	" " " " " Screw for 17898 and 17904.....
229J	5017	Button Clamp Spring Screw for 63928...
23227	3705	" " " " " Steady Pin for 17901
9311	3747	" " " " " " " 39238 and 39239.....
17722	3705	Button Clamp Stop with two 17720, for 17898.....
17903	3708	Button Clamp Stop with two 17720, for 17904.....
39248	3748	Button Clamp Stop with two 17720, for 63928.....
1183J	3705	Button Clamp Stop Screw.....
17723	3704	" " " Stud.....
17898	3703	Button Clamp (universal) complete, for 14 to 36 line buttons, Nos. 236J, 1180J, 1181J, 1182J, 1183J, 17706, 17707, 17716 to 17719, 17721 or 17938, 17722, 17901, 50237K and two 1175J.....
17904	—	Button Clamp (universal) complete, for 26 to 46 line buttons, Nos. 236J, 1180J, 1181J, 1182J, 1183J, 17716 to 17719, 17899 to 17901, 17902 or 17939, 17903, 50237K and two 1175J.....

PARTS FOR MACHINE No. 69-5

NO.	PLATE	NAME
63928	—	Button Clamp (universal) complete, for 10 to 50 line thin buttons, Nos. 1180j, 1181j, 1182j, 1183j, 17717 to 17719, 39238, 39239, 39242, 39244 or 39246, 39245 or 39247, 39248, 50237k, 63927 and two each 229j and 1175j.
4292	5002	Crank Connecting Rod with 4349 and two 158E.
*4349	—	Crank Connecting Rod Cap.
158E	3724	" " " " Screw.
375c	3724	" " " " Hinge Screw.
1518E	3718	" " " " Nut.
*18352	—	Cylinder.
18388	5008	" Block.
1300D	3748	" " Screw.
18427	5001	" End Cover with 18428, 18444 and three 4604.
18428	5008	Cylinder End Cover Bracket.
18444	5008	" " " " Hinge Pin.
4604	5008	" " " " Rivet.
18379	5008	" " " " Spring.
217D	3731	" " " " Screw.
17724	5001	Face Plate.
*63736	—	" " 17724 with 2105.
17725	—	Face Plate complete, Nos. 448c, 600c, 1560c, 2103, 2107, 2124, 2127, 63736 and two each 233D and 2102.
164D	3724	Face Plate Screw.
2107	3722	" " Thread Guard.
233D	3722	" " " " Screw.
18353	5006	Feed Across Connection with 18354 and two 175E.
*18354	—	Feed Across Connection Cap.
175E	5021	" " " " Screw.
18355	5008	" " Knuckle Joint.
1184c	5008	" " " " Hinge Screw.
18356	5006	" " Regulator with 1952.
1187E	5008	" " " " Adjusting Stud.
1676c	5008	" " " " " Nut.
17738	5008	" " " " " " Washer.
17739	5008	Feed Across Regulator Adjusting Stud Sleeve.
18357	5008	Feed Across Regulator Hinge Stud.
690D	3748	" " " " " Clamp- ing Screw.
1952	5008	Feed Across Regulator Roller and Stud.

PARTS FOR MACHINE No. 69-5

NO.	PLATE	NAME
18358	5002	Feed Across Shaft.
18359	5008	" " " " Collar with two 200F.
200F	5008	" " " " Set Screw.
18360	5008	" " " " Crank (back) with 160E and 200c.
18361	5007	Feed Across Shaft Crank (back) Ball Stud
200c	5008	" " " " " " " " " " Set Screw.
160E	5008	Feed Across Shaft Crank (back) Clamping Screw.
18362	5007	Feed Across Shaft Crank (front) with 160E and 18363.
160E	5008	Feed Across Shaft Crank (front) Clamping Screw.
18363	5007	Feed Across Shaft Crank (front) Stud.
18364	5007	" " " " " " Slide Block.
18395	5004	Feed Cam with two each 1192c, 17874 and four 190D.
18415	5007	Feed Cam Driving Worm with 1441c and 1442c.
1442c	5021	Feed Cam Driving Worm Position Screw.
1441c	5021	" " " " Set Screw.
17797	5004	" " " " Wheel with 453c
3012	3722	" " " " " Pin.
453c	5007	" " " " " Set Screw
18384	5007	" " Pin.
1192c	3724	" " Set Screw.
18416	5004	" " Shaft.
18417	5004	" " " Bracket.
1177D	3710	" " " " Screw (back)...
1193D	3724	" " " " " (front)...
1653c	3724	" " " Nut.
17800	5013	" Plate (thin) for flat buttons.
17923	5013	" " (thick) for round bottom buttons.
*18445	5002	" " Carrier Bar.
18365	—	" " " " 18445 with 934D; 1195E, 1221c, 17743, 18366, 18390, two 55300 and four 17806.
18366	5007	Feed Plate Carrier Bar Block.
18367	5007	" " " " " Cover.
1221c	5007	" " " " " Screw.
55300	5042	" " " " " Steady Pin
17805	5007	" " " " " Pivot Block.
1194D	5007	" " " " " " Screw
18390	5007	" " " " " Plate.
934D	5007	" " " " " " Screw.

NO.	PLATE	NAME
1654c	5013	Feed Plate Nut.....
17806	5013	" " Position Stud.....
1195E	5013	" " Screw Stud.....
17742	5006	" Regulator with 1953.....
18369	5006	" " Bracket with 690D, 17732 and two 160D.....
*17732'	—	Feed Regulator Bracket Cap.....
160D	5008	" " " " Screw.....
8589	3722	" " " " Dowel Pin.....
1177E	3710	" " " " Screw.....
17744	5009	" " Hinge Stud.....
17743	5009	" " Post.....
1953	5021	" " Roller and Screw Stud with 1655c and 14017.....
1655c	5021	Feed Regulator Roller and Screw Stud Nut.....
14017	5015	Feed Regulator Roller and Screw Stud Nut Washer.....
1190c	5009	Feed Regulator Stop Screw.....
17745	5009	" " Swivel.....
1191D	5009	" " Thumb Screw.....
18389	5015	Knife (needle thread).....
17808	5015	" (shuttle thread).....
18370	5000	" Bar with 18373 and two 17822....
18371	5015	" " Cap.....
217D	3731	" " " " Screw.....
18372	5016	" " Connection with 17917.....
190D	3710	" " " " Screw.....
7071	5008	" " " " Washer.....
17915	5016	" " " " Slide Block.....
17917	—	" " " " " " 17915 with 17916.....
17916	5016	Knife Bar Connection Slide Block Stud
39297	5016	" " Driving Lever with 190D, 1420E, 17919 and 39298.....
1382F	5016	Knife Bar Driving Lever Hinge Screw....
1681c	5016	" " " " " " Nut
39298	5016	" " " " " " Lock Stud.....
17919	5016	" " " " " " Spring
190D	3710	" " " " " " " " Screw.....
1420E	5016	Knife Bar Driving Lever Lock Stud Stop Screw.....
18373	5015	Knife Bar Rack.....
17822	5015	" " " " Rivet.....
39235	5006	" Cam Lever Body.....
39409	—	" " " " 39235 with 39460

NO.	PLATE	NAME
39329	5029	Knife Cam Lever complete, Nos. 19793 and 39409.....
18470	5028	Knife Cam Lever Bracket with 1177D....
8589	3722	" " " " Dowel Pin....
670E	5021	" " " " Screw.....
50029c	3759	" " " " Hinge Screw.....
18471	3759	" " " " " " Bushing
*18472	—	" " " " " " " 18471 with 50029c.....
1177D	3710	Knife Cam Lever Hinge Screw Bushing Clamping Screw.....
1980	3759	Knife Cam Lever Roller and Screw Stud with 1654c.....
1654c	5013	Knife Cam Lever Roller and Screw Stud Nut.....
39330	3759	Knife Cam Lever Slide with 1980.....
39460	—	" " " " 39330 with 1255D and 39331.....
1255D	5021	Knife Cam Lever Slide Screw.....
39331	3759	" " " " " " Washer....
19793	5015	" " " " Steady Pin.....
17825	5015	" Holder with 17826, 17830 and two 7298.....
*55296	—	Knife Holder 17825 with 1198c, 17808, 17829 and 18389.....
17826	5015	Knife Holder Pinion.....
7298	5015	" " " " Dowel Pin.....
17827	5015	" " " " Stud.....
17828	5015	" " " " " " Bracket with 17827.....
50018F	5021	Knife Holder Pinion Stud Bracket Screw..
1698c	5021	" " " " " " " " Nut
1198c	5015	" Screw.....
17829	5015	" Thread Holder.....
17830	5015	" " " " Position Pin.....
17831	5002	Needle Bar with 237F.....
39203	3718	" " Connecting Link.....
377c	3718	" " " " " " Hinge Screw
1518E	3718	" " " " " " " " Nut.....
21629	3718	Needle Bar Connecting Stud with 155c...
155c	3718	" " " " " " Set Screw...
39350	5029	" " Thread Nipper Driving Lever (adjustable) with 39351 and two 335D..
39351	3759	Needle Bar Thread Nipper Driving Lever Extension.....

NO.	PLATE	NAME
335D	3759	Needle Bar Thread Nipper Driving Lever Extension Screw.....
1196c	3721	Needle Bar Thread Nipper Driving Lever Hinge Screw.....
39352	5029	Needle Bar Thread Nipper Driving Lever Spring.....
17834	3718	Needle Bar Thread Nipper Lever with 17835.....
17835	3718	Needle Bar Thread Nipper Lever Bushing
1200D	3718	" " " " Hinge Screw.....
39276	5009	Needle Bar Thread Nipper Lever Spring
1329D	5009	" " " " " " Screw.....
17837	5019	Needle Bar Thread Nipper Rod.....
17838	3718	" " " " " Adjusting Stud.....
1651E	5021	Needle Bar Thread Nipper Rod Adjusting Stud Lock Nut.....
17839	3718	Needle Bar Thread Nipper Rod Arm with 196F.....
196F	3718	Needle Bar Thread Nipper Rod Arm Set Screw.....
17840	5001	Needle Bar Thread Nipper Rod Support
190D	3710	" " " " " " Screw.....
237F	3724	Needle Set Screw.....
6022	5001	Oscillating Rock Shaft (steel) with 4784..
*55278	—	Oscillating Rock Shaft complete, Nos. 1513J, 6022 and 6489.....
6489	5001	Oscillating Rock Shaft Hinge Pin.....
1513J	3724	" " " " " Nut...
4784	5009	" " " Oil Pad.....
18385	5002	" Shaft.....
18386	—	" " Crank.....
18387	5017	Oscillating Shaft Crank complete, Nos. 237F, 1519E, 15171 and 18386.....
2049	5017	Oscillating Shaft Crank Pin.....
237F	5017	" " " Set Screw.....
15170	5017	" " " Slide Block.....
229D	5017	" " " " " Cap Screw.....
12424	5017	Oscillating Shaft Crank Slide Block Cap Screw Washer.....
1035c	5017	Oscillating Shaft Crank Slide Block Screw Stud.....

NO.	PLATE	NAME
1519E	5017	Oscillating Shaft Crank Slide Block Screw Stud Nut.....
15171	5017	Oscillating Shaft Crank Slide Block complete, Nos. 229D, 1035c, 12424 and 15170.....
2058	5002	Presser Bar.....
17841	3718	" " Collar with two 196F.....
196F	3718	" " Set Screw.....
17842	3718	" " Guide Bracket with 453c....
453c	5007	" " " " Set Screw....
17843	5006	" " Lifting Lever.....
17844	5006	" " " Bracket.....
164E	3724	" " " " " Screw..
1201c	5021	" " " " Hinge Screw....
17845	5019	" " " " Rod.....
17846	—	" " " " Chain....
8414	5001	" " Spring.....
17941	5003	Pulley (loose) 2 1/8 in. diam.....
17848	5003	" " Bushing.....
2269	3722	" " Position Pin.....
1202D	3724	" " Cap Screw.....
17942	5003	" (tight) 2 1/8 in. diam., with 2269....
2022	3722	" " Pin.....
17955	—	Pulleys complete, Nos. 1202D, 1206C, 17848, 17854, 17941 and 17942.....
2996	5017	Shuttle Bobbin.....
15140	5017	" " Case Latch.....
2973	5017	" " " Lever.....
2974	5017	" " " " Fulcrum Pin.....
2975	5017	Shuttle Bobbin Case Latch Spring.....
592E	5017	" " " " Stop Screw...
15141	—	" " " Hinge, Nos. 2973, 2974 and 15140.....
15027	5017	Shuttle Bobbin Case Position Finger....
2523	5017	" " " " Rivet.....
15277	5017	Shuttle Bobbin Case complete, Nos. 591F, 592E, 2523, 2975, 15027, 15141 and 15278.....
21562	5017	Shuttle Body.....
591F	5017	" Tension Regulating Screw.....
15278	5017	" " Spring.....
21561	5017	Shuttle, 1 1/4 in. diam., Nos. 2996, 15277 and 21562.....
*2542	—	Shuttle Driver.....
2441	5017	" " 2542 with two 462c.....
2049	5017	" " Pin.....

NO.	PLATE	NAME
462c	5017	Shuttle Driver Set Screw.....
18411	—	“ Race Body.....
21623	5018	“ “ Cap.....
662d	5018	“ “ “ Screw.....
2523	5018	“ “ “ Steady Pin.....
18429	5018	“ “ “ Ring.....
18413	5018	“ “ “ Spring.....
1289d	5018	“ “ “ “ Screw.....
18430	5018	Shuttle Race (flexible) complete, Nos. 662d, 2523, 18411, 18429, 21623 and two each 1289d and 18413.....
171d	5018	Shuttle Race Screw.....
17853	5003	Starting Lever.....
1262c	5021	“ “ Hinge Screw.....
1662c	5021	“ “ “ Nut.....
17886	5019	“ “ Pitman.....
17854	3721	Stop Cam.....
17855	3721	“ “ Interlocking Rod.....
18492	5028	“ “ “ Case with 18443 and two 193f.....
*55285	—	Stop Cam Interlocking Rod Case 18492 with 1318d, 17855, 17863, 17864, 39222, 39223 and two 1255d.....
39346	5028	Stop Cam Interlocking Rod Case Bracket
*55304	—	Stop Cam Interlocking Rod Case Bracket complete, Nos. 1182e, 1196c, 1204e, 1254c, 1262c, 1508e, 1662c, 17853, 17859, 17861, 17862, 17872, 17873, 39346, 55285 and two 898d.....
18493	—	Stop Cam Interlocking Rod Case Bracket 55304 with 39343, 39344 and two 1186d
16532	3722	Stop Cam Interlocking Rod Case Bracket Dowel Pin.....
1343E	5021	Stop Cam Interlocking Rod Case Bracket Screw.....
1204E	3721	Stop Cam Interlocking Rod Case Hinge Screw.....
17859	5003	Stop Cam Interlocking Rod Case Socket Joint.....
898d	3721	Stop Cam Interlocking Rod Case Socket Joint Cap Screw.....
39343	5028	Stop Cam Interlocking Rod Case Spring (flat).....
430c	3759	Stop Cam Interlocking Rod Case Spring Adjusting Screw.....
1520E	3759	Stop Cam Interlocking Rod Case Spring Adjusting Screw Nut.....

NO.	PLATE	NAME
39344	3759	Stop Cam Interlocking Rod Case Spring Bracket with 430c and 1520E.....
1186d	5021	Stop Cam Interlocking Rod Case Spring Bracket Screw.....
17861	3721	Stop Cam Interlocking Rod Case Stop Stud.....
1254c	5021	Stop Cam Interlocking Rod Case Stop Stud Screw Bushing.....
1508E	5021	Stop Cam Interlocking Rod Case Stop Stud Screw Bushing Lock Nut.....
17862	3721	Stop Cam Interlocking Rod Case Stop Stud Spring.....
18443	5015	Stop Cam Interlocking Rod Case Wearing Block.....
193f	5015	Stop Cam Interlocking Rod Case Wearing Block Screw.....
17863	3721	Stop Cam Interlocking Rod Spring.....
17864	3721	“ “ “ “ Stop.....
1318d	3748	“ “ “ “ “ Screw.....
3012	3722	“ “ Pin.....
1206c	3721	“ “ Screw.....
2102	3722	Tension Disc.....
1560c	3722	“ Regulating Thumb Nut.....
600c	3722	“ Screw Stud.....
448c	3722	“ “ “ Set Screw.....
2103	3722	“ Spring.....
2105	3722	“ Thread Guard.....
*55302	—	Thread Take-up Cam.....
18392	5003	“ “ “ 55302 with 446c.....
3012	3722	“ “ “ Pin.....
446c	3724	“ “ “ Set Screw.....
18393	5002	“ “ Lever with 1822.....
79c	5021	“ “ “ Hinge Screw.....
1822	5021	“ “ “ Roller and Stud.....
2124	3722	“ “ Spring.....
2127	3722	“ “ “ Regulator Plate
233d	3722	“ “ “ “ “ “ Adjusting Screw.....
17865	3710	Thread Wiper Body.....
1207d	3710	“ “ “ Hinge Screw.....
17866	3710	“ “ “ Hook.....
17867	3710	“ “ “ Support.....
647c	5021	“ “ “ “ Set Screw.....
17868	3710	“ “ “ Wire.....
337d	3718	“ “ “ “ Screw.....
17869	3710	“ “ “ “ “ Washer.....

NO.	PLATE	NAME
18381	5020	Throat Plate with 17871 and two 1208D, for flat buttons.....
55301	—	Throat Plate 18381 with 1698c, 17828, 50018r and 55296.....
55314	—	Throat Plate with 39486 and two 1208D, for flat buttons.....
55315	—	Throat Plate 55314 with 1698c, 17828, 50018r and 55296.....
18382	—	Throat Plate with 17924 and two 1208D, for round bottom buttons.....
55306	—	Throat Plate 18382 with 1698c, 17828, 50018r and 55296.....
17871	5020	Throat Plate Needle Hole Bushing (small needle hole) for 18381.....
17924	5020	Throat Plate Needle Hole Bushing (small needle hole) for 18382.....
39486	—	Throat Plate Needle Hole Bushing (large needle hole) for 55314.....
1208D	5020	Throat Plate Needle Hole Bushing Screw
691F	5015	" " Screw.....
17872	3721	Trip Lever.....
1196c	3721	" " Hinge Screw.....
17873	3721	" " Spring.....
1182E	3705	" " Screw.....
17874	5009	Tripping Point.....
190D	3710	" " Screw.....

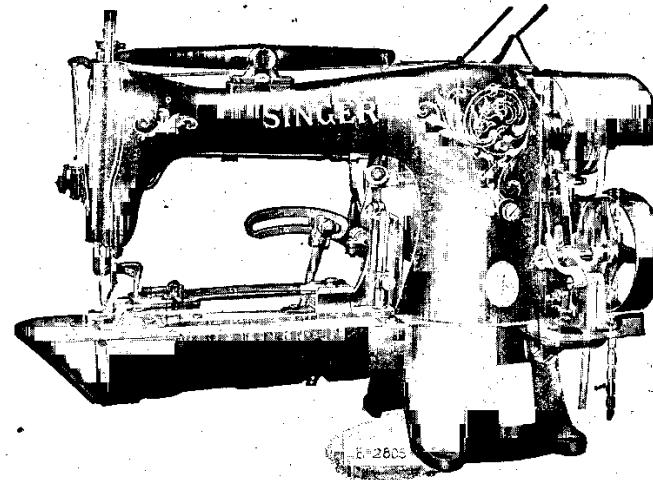

MACHINE No. 69-6

FOR SEWING ON SMALL BUTTONS ONLY. FOR SHIRTS, WAISTS,
UNDERWEAR, ETC. MAKES CROSS STITCHES IN FOUR-
HOLE BUTTONS AND CAN BE ADJUSTED FOR TWO-HOLE
AND BAR BUTTONS. MAKES ELEVEN CROSS AND THREE
TYING STITCHES.

This Machine is the same as 69-5
with the following exception:

NO.	PLATE	NAME
18396	—	Feed Cam with two 1192c, three 17874 and six 190D, in place of 18395.....

MACHINE No. 69-7

FOR SHOE TACKING. MAKES TWO STAY, NINE LONG,
SEVEN CROSS AND THREE TYING STITCHES.

This Machine is the same as 69-5
with the following exceptions:

NO.	PLATE	NAME
63811	7205	Clamp Arm (lower) with two 17992.....
17992	3740	" " " Hook.....

NO.	PLATE	NAME
63812	7205	Clamp Arm (upper)
39333	3761	" " Bracket
39336	3761	Clamp Arm Bracket (adjustable) complete, Nos. 129r, 1178j, 1300b, 1654c, 39333 to 39335 and 50048j, in place of 17713
129r	3761	Clamp Arm Bracket Adjusting Screw
39334	3761	" " " Hinge Block
1300b	3761	" " " " " Screw, in place of 1177
50048j	3761	Clamp Arm Bracket Hinge Screw (eccen- tric)
1654c	3761	Clamp Arm Bracket Hinge Screw Nut
17958	3733	" " Lifter with 17866, in place of 17708
190b	3710	Clamp Arm Lifter Screw
9330	3740	" " Pin
1178j	3761	" " Screw
39335	3761	" " " Plate
18490	—	Clamp complete, Nos. 1654c, 9330, 18365, 18367, 39304, 39336, 63811 and 63812, in place of 17898, 17904 and 63928.
18397	—	Feed Cam with 17874 and two each 190b and 1192c, in place of 18395
39231	5005	Feed Cam Driving Worm with 1441c and 1442c, in place of 18415
17997	5004	Feed Cam Driving Worm Wheel with 453c, in place of 17797
39304	5014	Feed Plate, in place of 17809 and 17923

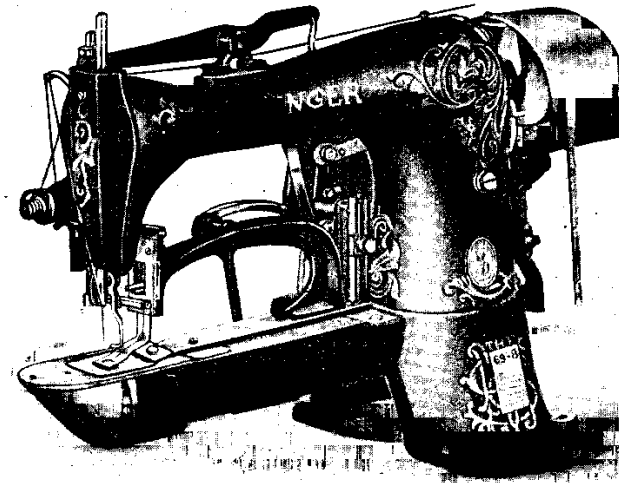

MACHINE No. 69-8

FOR BARRING POCKETS ON CLOTHING. MAKES BAR $\frac{1}{16}$ TO $\frac{5}{8}$
INCH LONG, CONSISTING OF TWELVE STAYING, TWENTY-
SEVEN COVERING AND THREE TYING STITCHES.

This Machine is the same as 69-5
with the following exceptions:

NO.	PLATE	NAME
17964	3733	Arch Clamp Foot (left) with 17959
17965	3733	" " " (right) with 17959
17958	3733	" " " Lifter with 17866, in place of 17708
190b	3710	Arch Clamp Foot Lifter Screw
17959	3731	" " " Lifting Stud
17966	3733	" " " Plate
217j	3731	" " " " Screw
39302	3731	" " " Spring
17967	3733	" " " " Connection
1175j	3704	" " " " " Hinge Screw

NO.	PLATE	NAME
217J	3731	Arch Clamp Foot Spring Screw.....
17968	3732	" " Frame.....
14079	3731	" " " Dowel Pin.....
1177D	3710	" " " Screw.....
18449	—	Arch Clamp complete, Nos. 1654c, 17964 to 17968, 17970, 18367, 18448, 39302, two each 1175J, 1177D, 14079 and five 217J, in place of 17898, 17904 and 63928
*18457	—	Arm with 4449, 17844 and two 164E, in place of 18439.....
18421	5009	Feed Across Shaft Crank (back) with 160E and 200c, in place of 18360.....
18422	5009	Feed Across Shaft Crank (back) Ball Stud, in place of 18361.....
18398	—	Feed Cam with 17874 and two each 190D and 1192c, in place of 18395.....
17970	3740	Feed Plate, in place of 17800 or 17923...
*18447	5012	" " Carrier Bar, in place of 18445
18448	—	" " " " 18447 with 934d, 1195E, 1221c, 17743, 18390, 55295, two 55300 and four 17806, in place of 18365
55295	5042	Feed Plate Carrier Bar Block, in place of 18366.....
39283	5009	Hand Stop Lever.....
86D	5009	" " " Hinge Screw.....
39284	5000	" " " Rod.....
21678	5009	" " " " Collar with 1019c
1019c	5009	" " " " " Set Screw..
39285	5009	" " " " Connection.....
93F	5009	" " " " " Screw..
39286	5009	" " " " Guide Stud (back)
39287	5009	" " " " " (front)
1565D	5009	" " " " Head.....
24122	5009	" " " " Spring.....
39348	5028	Stop Cam Interlocking Rod Case Bracket
*55305	—	Stop Cam Interlocking Rod Case Bracket complete, Nos. 1182E, 1196c, 1204E, 1254c, 1262c, 1508E, 1662c, 17853, 17859, 17861, 17862, 17872, 17873, 39348, 55285 and two 898D, in place of 55304.....
18494	—	Stop Cam Interlocking Rod Case Bracket 55305 with 39343, 39344 and two 1186D, in place of 18493.....

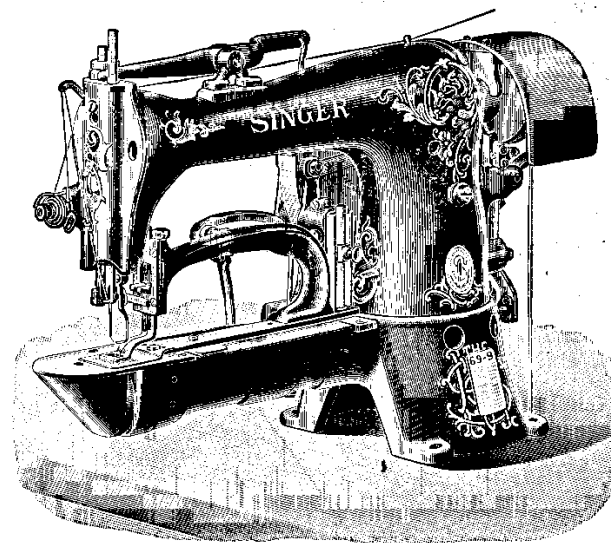

MACHINE No. 69-9

FOR BARRING BUTTONHOLES IN FINE WORK AND FOR FASTENING BOWS OR OTHER ORNAMENTS UPON SHOES OR GARMENTS. MAKES BAR $\frac{1}{8}$ TO $\frac{1}{4}$ INCH LONG, CONSISTING OF SEVEN STAYING, ELEVEN COVERING AND THREE TYING STITCHES.

This Machine is the same as 69-5 with the following exceptions:

NO.	PLATE	NAME
18431	5011	Arch Clamp Foot (left) with 17959.....
18432	5011	" " " (right) with 17959.....
17958	3733	" " " Lifter with 17866, in place of 17708.....
190D	3710	Arch Clamp Foot Lifter Screw.....
17959	3731	" " " Lifting Stud.....
18433	5011	" " " Plate.....
217J	3731	" " " " Screw.....
39302	3731	" " " Spring.....

NO.	PLATE	NAME
18434	5011	Arch Clamp Foot Spring Connection.....
1175j	3704	" " " " " Hinge Screw.....
217j	3731	Arch Clamp Foot Spring Screw.....
18435	5010	" " Frame.....
14079	3731	" " " Dowel Pin.....
181d	3738	" " " Screw.....
18436	—	Arch Clamp complete, Nos. 1654c, 18367, 18431 to 18435, 18438, 18459, 39302, two each 181d, 1175j, 14079 and five 217j, in place of 17898, 17904 and 63928
18421	5009	Feed Across Shaft Crank (back) with 160e and 200c, in place of 18360.....
18422	5009	Feed Across Shaft Crank (back) Ball Stud, in place of 18361.....
18399	—	Feed Cam with two each 1192c, 17874 and four 190d, in place of 18395.....
18459	5011	Feed Plate, in place of 17800 or 17923...
*18437	5012	" " Carrier Bar, in place of 18445
18438	—	" " " " 18437 with 934d, 1195e, 1221c, 17743, 18390, 55295, two 55300 and four 17806, in place of 18365
55295	5042	Feed Plate Carrier Bar Block, in place of 18366.....

MACHINE No. 69-10

FITTED WITH CLAMP FOR CLOSING THE BUTTON-
HOLE BEFORE BARRING.

This Machine is the same as 69-5
with the following exceptions:

NO.	PLATE	NAME
17976	3737	Clamp Arm (lower) left.....
17977	3737	" " " right.....
17978	3737	" " " Bracket.....
181j	3738	" " " " Screw.....
7401	3738	" " " " Steady Pin..
90j	3738	" " " " Hinge Screw.....
17979	3738	" " (upper) left, with 17986 and 39257.....
17980	3738	Clamp Arm (upper) right, with 17986 and 39257.....
17981	3737	Clamp Arm (upper) Bracket.....
14008	3737	" " " " Hinge Pin..

NO.	PLATE	NAME
90j	3738	Clamp Arm (upper) Hinge Screw.....
39257	5009	" " " Hook.....
17958	3733	" " " Lifter with 17866, in place of 17708.....
190d	3710	Clamp Arm (upper) Lifter Screw.....
17982	3738	" Pressure Spring.....
17713	3710	" " " Bracket.....
1177d	3710	" " " " Screw...
1178j	3710	" " " Screw.....
17983	3737	" Spreader Lever.....
957k	3738	" " " Cap Screw.....
17984	3738	" " " Friction Washer..
17985	3738	" " " Hinge Stud.....
17986	3738	" " Stud.....
18452	—	Clamp complete, Nos. 181j, 957k, 1177d, 1178j, 14008, 17713, 17976 to 17984, 17988, 17989, 18367, 18451, two 7401 and four each 90j and 17806, in place of 17898, 17904 and 63928.....
18399	—	Feed Cam with two each 1192c, 17874 and four 190d, in place of 18395.....
17988	3737	Feed Plate (left).....
17989	3737	" " (right).....
17806	5013	" " Rivet.....
*18450	5012	" " Carrier Bar, in place of 18445
18451	—	" " " " 18450 with 934d, 1221c, 17743, 17985, 18366, 18390 and two 55300, in place of 18365.....

MACHINE No. 69-11

FOR SEWING STRAPS UPON UNDERWEAR AND OTHER GAR-
MENTS. MAKES BAR $\frac{3}{8}$ TO $\frac{7}{8}$ INCH LONG, CONSISTING
OF THREE STAYING, THIRTY-SIX COVERING AND THREE
TYING STITCHES.

This Machine is the same as 69-5
with the following exceptions:

NO.	PLATE	NAME
17957	3731	Arch Clamp Foot with 17959.....
39206	3731	" " " Lifter with 17866, in place of 17708.....
190d	3710	Arch Clamp Foot Lifter Screw.....
17959	3731	" " " Lifting Stud.....
17960	3731	" " " Plate.....

NO.	PLATE	NAME
217J	3731	Arch Clamp Foot Plate Screw.....
39303	3731	" " " Spring.....
217J	3731	" " " " Screw (lower)...
1175J	3704	" " " " " (upper)...
39250	5010	" " Frame.....
14079	3731	" " " Dowel Pin.....
181D	3738	" " " Screw.....
18453	—	Arch Clamp complete, Nos. 1175J, 1654c, 17957, 17960, 17963, 18367, 18438, 39250, 39303, two each 181D, 14079 and five 217J, in place of 17898, 17904 and 63928.....
18421	5009	Feed Across Shaft Crank (back) with 160E and 200c, in place of 18360.....
18422	5009	Feed Across Shaft Crank (back) Ball Stud, in place of 18361.....
18401	—	Feed Cam with 17874 and two each 190D and 1192c, in place of 18395.....
17963	3731	Feed Plate, in place of 17800 and 17923..
*18437	5012	" " Carrier Bar, in place of 18445
18438	—	" " " " 18437 with 934D, 1195E, 1221c, 17743, 18390, 55295, two 55300 and four 17806, in place of 18365
55295	5042	Feed Plate Carrier Bar Block, in place of 18366.....
18426	5000	Knife Bar with 18373 and two 17822, in place of 18370.....
18454	—	Throat Plate with 39213 and two 1208D, in place of 18381 and 18382.....
*55310	—	Throat Plate 18454 with 1698c, 17828, 50018F and 55296, in place of 55301 and 55306.....
39213	3731	Throat Plate Needle Hole Bushing, in place of 17871 and 17924.....

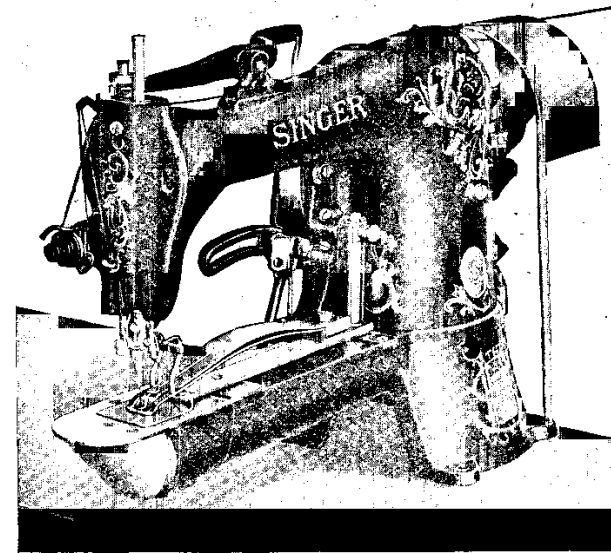

MACHINE No. 69-12

FOR SHOE TACKING. MAKES TACK UP TO $\frac{3}{8}$ INCH LONG,
CONSISTING OF TWO STAY, NINE LONG AND SEVEN
CROSS STITCHES.

This Machine is the same as 69-5
with the following exceptions:

NO.	PLATE	NAME
63811	7205	Clamp Arm (lower) with two 17992.....
17992	3740	" " " Hook.....
63812	7205	" " (upper).....
39333	3761	" " Bracket.....
39336	3761	Clamp Arm Bracket (adjustable) com- plete, Nos. 129J, 1178J, 1300D, 1654c, 39333 to 39335 and 50048J, in place of 17713.....
129J	3761	Clamp Arm Bracket Adjusting Screw....
39334	3761	" " " Hinge Block.....

NO.	PLATE	NAME
1300d	3761	Clamp Arm Bracket Hinge Block Screw, in place of 1177.....
50048j	3761	Clamp Arm Bracket Hinge Screw (eccentric).....
1654c	3761	Clamp Arm Bracket Hinge Screw Nut....
17958	3733	" " Lifter with 17866, in place of 17708.....
190d	3710	Clamp Arm Lifter Screw.....
9330	3740	" " Pin.....
1178j	3761	" " Screw.....
39335	3761	" " " Plate.....
18490	—	Clamp complete, Nos. 1654c, 9330, 18365, 18367, 39304, 39336, 63811 and 63812, in place of 17898, 17904 and 63928.
18421	5009	Feed Across Shaft Crank (back) with 160z and 200c, in place of 18360.....
18456	5016	Feed Across Shaft Crank (back) Ball Stud, in place of 18361.....
18402	—	Feed Cam with two each 1192c, 17874 and four 190d, in place of 18395.....
39211	5005	Feed Cam Driving Worm with 1441c and 1442c, in place of 18415.....
39212	5002	Feed Cam Driving Worm Wheel with 453c, in place of 17797.....
39304	5014	Feed Plate, in place of 17800 and 17923..

MACHINE No. 69-13

MAKES ELEVEN CROSS AND THREE FASTENING OR TYING STITCHES. FOR TACKING BOWS OR OTHER ORNAMENTS TO SHOES.

This Machine is the same as 69-5 with the following exceptions:

NO.	PLATE	NAME
17999	3739	Clamp Arm with two 39257.....
39333	3761	" " Bracket.....
39336	3761	Clamp Arm Bracket (adjustable) complete, Nos. 129j, 1178j, 1300d, 1654c, 39333 to 39335 and 50048j, in place of 17713
129j	3761	Clamp Arm Bracket Adjusting Screw....
39334	3761	" " " Hinge Block.....
1300d	3761	" " " " " Screw, in place of 1177.....
50048j	3761	Clamp Arm Bracket Hinge Screw (eccentric).....

NO.	PLATE	NAME
1654c	3761	Clamp Arm Bracket Hinge Screw Nut....
39257	5009	" " Hook.....
17958	3733	" " Lifter with 17866, in place of 17708.....
190d	3710	Clamp Arm Lifter Screw.....
1178j	3761	" " Screw.....
39335	3761	" " " Plate.....
18491	—	Clamp complete, Nos. 1654c, 17999, 18365, 18367, 39258 and 39336, in place of 17898, 17904 and 63928.....
18403	—	Feed Cam with two 1192c, three 17874 and six 190d, in place of 18395.....
39258	5014	Feed Plate (thin) in place of 17800.....
39362	—	" " (thick) in place of 17923.....

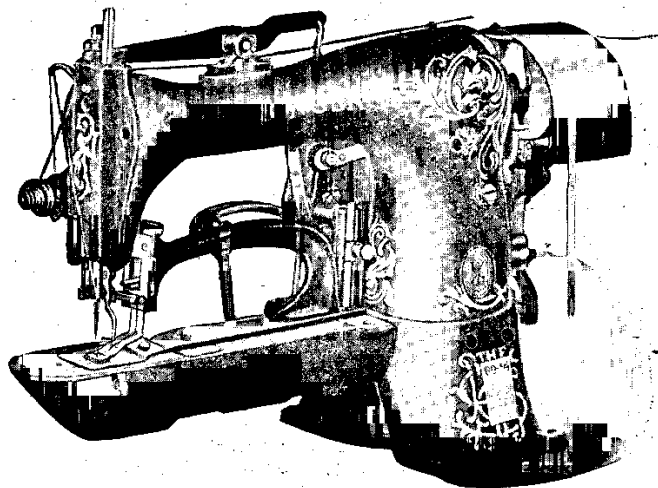

MACHINE No. 69-14.

FOR TACKING BLUCHER SHOES. MAKES TACK $\frac{1}{32}$ TO $\frac{1}{16}$ INCH LONG, CONSISTING OF EIGHTEEN STAYING STITCHES IN TWO PARALLEL LINES AND THREE TYING STITCHES.

This Machine is the same as 69-5 with the following exceptions:

NO.	PLATE	NAME
18473	5030	Arch Clamp Foot (left).....
18474	5030	" " " " 18473 with 219k and 18478.....
18475	5030	Arch Clamp Foot (right).....
18476	5030	" " " " 18475 with 219k and 18479.....
17958	3733	Arch Clamp Foot Lifter with 17866, in place of 17708.....
190D	3710	Arch Clamp Foot Lifter Screw.....
39307	5030	" " " " Lifting Stud.....
18477	5030	" " " " Plate.....
190J	3710	" " " " Screw.....
219K	5030	" " " " Screw.....

PARTS FOR MACHINE No. 69-14

NO.	PLATE	NAME
18478	—	Arch Clamp Foot Shank (left) with 39307
18479	—	" " " " (right) with 39307
18480	3739	" " " " Spring (heavy).....
18481	3739	" " " " (light).....
1229F	5021	" " " " Adjusting Screw
1547J	5021	" " " " " " " "
		Lock Nut.....
18482	5031	Arch Clamp Frame.....
14079	3731	" " " " Dowel Pin.....
181D	5021	" " " " Screw.....
18483	—	Arch Clamp complete, Nos. 1654c, 18367, 18474, 18476, 18477, 18482, 18484, 18486, two each 181D, 1229F, 1547J, 14079, 18481 and four 190J, in place of 17898, 17904 and 63928.....
18404	—	Feed Cam with two each 1192c, 17874 and four 190D, in place of 18395.....
18484	5030	Feed Plate, in place of 17800 and 17923..
*18485	5012	" " " " Carrier Bar, in place of 18445
18486	—	" " " " 18485 with 810D, 934D, 1195E, 1221C, 18390, 18488, 18489, 55295, two 55300 and four 17806, in place of 18365.....
55295	5042	Feed Plate Carrier Bar Block, in place of 18366.....
18487	5029	Feed Regulator with 1953, in place of 17742.....
18488	3759	Feed Regulator Post, in place of 17743...
18489	3759	" " " " Guide.....
810D	3759	" " " " " " Cap Screw...

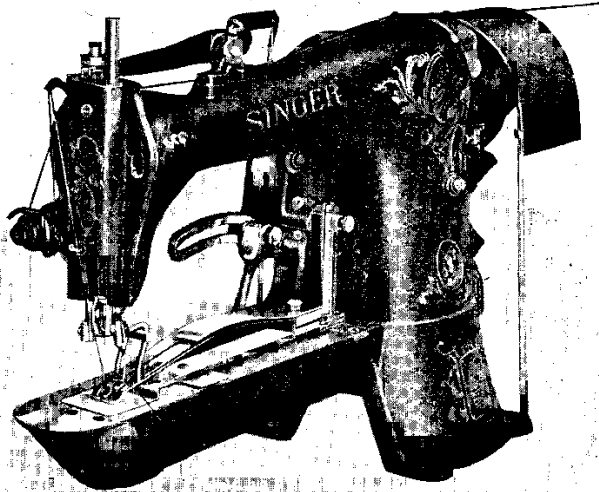

MACHINE No. 69-15

FOR STITCHING LARGE BUTTONS UPON COATS, CLOAKS, OVERCOATS, ETC. MAKES CROSS STITCHES IN FOUR-HOLE BUTTONS AND CAN BE ADJUSTED FOR TWO-HOLE AND BAR BUTTONS. NEEDLE THROW $\frac{3}{8}$ TO $\frac{1}{2}$ INCH. MAKES EIGHTEEN CROSS AND THREE TYING STITCHES.

This Machine is the same as 69-5 with the following exceptions:

NO.	PLATE	NAME
18464	3764	Button Clamp (left) with 9311 and 17723
18465	3764	" " (right) with 9311 and 17723
18466	3764	" " Stop with two 17720.....

PARTS FOR MACHINE No. 69-15

NO.	PLATE	NAME
63929	—	Button Clamp (universal) complete, for 26 to 55 line buttons, Nos. 1180r, 1181r, 1182r, 1183r, 17717 to 17719, 18464 to 18466, 39242, 39244 or 39246, 39245 or 39247, 50237k, 63927 and two each 229r and 1175r, in place of 17898, 17904 and 63928.....
18405	—	Feed Cam with 17874 and two each 190d and 1192c, in place of 18395.....
39231	5005	Feed Cam Driving Worm with 1441c and 1442c, in place of 18415.....
17997	5004	Feed Cam Driving Worm Wheel with 453c, in place of 17797.....
18468	3764	Feed Plate, in place of 17800 and 17923
39312	5029	" Regulator with 1953, in place of 17742
18469	5029	" " Bracket with 690d, 39310 and two 160d, in place of 18369.....
*39310	—	Feed Regulator Bracket Cap, in place of 17732.....
39313	3759	Feed Regulator Swivel, in place of 17745

MACHINE No. 69-16

FOR TACKING MEN'S AND BOYS' BLUCHER SHOES. MAKES TACK $\frac{3}{4}$ TO $\frac{1}{16}$ INCH, CONSISTING OF EIGHTEEN STITCHES IN TWO PARALLEL LINES, AND THREE TYING STITCHES, HAS LONG BEAK SHUTTLE.

This Machine is the same as 69-5 with the following exceptions:

NO.	PLATE	NAME
18473	5030	Arch Clamp Foot (left).....
18474	5030	" " " " 18473 with 219k and 18478.....
18475	5030	Arch Clamp Foot (right).....
18476	5030	" " " " 18475 with 219k and 18479.....
17958	3733	Arch Clamp Foot Lifter with 17866, in place of 17708.....
190d	3710	Arch Clamp Foot Lifter Screw.....
39307	5030	" " " Lifting Stud.....
18477	5030	" " " Plate.....
190r	3710	" " " Screw.....
219k	5030	" " " Screw.....
18478	—	" " " Shank (left) with 39307

NO.	PLATE	NAME
18479	—	Arch Clamp Foot Shank (right) with 39307
18480	3739	" " " Spring (heavy).....
18481	3739	" " " " (light).....
1229F	5021	" " " " Adjusting Screw
1547J	5021	" " " " " " "
		Lock Nut.....
18482	5031	Arch Clamp Frame.....
14079	3731	" " " Dowel Pin.....
181D	5021	" " " Screw.....
18483	—	Arch Clamp complete, Nos. 1654c, 18367, 18474, 18476, 18477, 18482, 18484, 18486, two each 181D, 1229F, 1547J, 14079, 18481 and four 190J, in place of 17898, 17904 and 63928.....
*55269	—	Cylinder, in place of 18352.....
18406	—	Feed Cam with two each 1192c, 17874 and four 190D, in place of 18395.....
18484	5030	Feed Plate, in place of 17800 and 17923.....
*18485	5012	" " Carrier Bar, in place of 18445.....
18486	—	" " " " 18485 with 810D, 934D, 1195E, 1221c, 18390, 18488, 18489, 55295, two 55300 and four 17806, in place of 18365.....
55295	5042	Feed Plate Carrier Bar Block.....
18487	5029	" Regulator with 1953, in place of 17742.....
18488	3759	Feed Regulator Post, in place of 17743.....
18489	3759	" " " Guide.....
810D	3759	" " " " Cap Screw.....
17807	5042	Knife (needle thread) in place of 18389.....
55317	—	" Holder 17825 with 1198c, 17807, 17808 and 17829, in place of 55296.....
6023	5028	Oscillating Shaft, in place of 18385.....
2073	3702	Shuttle Bobbin, in place of 2996.....
2211	3702	" " Retaining Spring.....
2212	3702	" " " Rivet.....
*39295	—	" Body with 398E, 2082, 2084, 2211 and two 2212.....
*2075	—	Shuttle Cover.....
*44001	—	" " 2075 with 112D, 466H, 2078, 2080, 2086 and 2090.....
2076	3702	Shuttle Cover Hinge Pin.....
2078	3702	" Delivery Eye Thread Guard.....
2080	3702	" " " Rivet.....
2082	3702	" Main Spring.....
398E	3702	" " " Screw.....
2084	3702	" " " Steady Pin.....

NO.	PLATE	NAME
466H	3702	Shuttle Tension Regulating Screw.....
2086	3702	" " Spring.....
2090	3702	" " " Plate.....
112D	3702	" " " Screw.....
39296	3702	Shuttle complete, Nos. 2073, 2076, 39295 and 44001, in place of 21561.....
39487	3702	Shuttle Driver with two 457c, in place of 2441.....
457c	3702	Shuttle Driver Set Screw.....
55270	—	" Race Body, in place of 18411.....
55271	5032	" " Ring, in place of 18429.....
55272	5032	Shuttle Race complete, Nos. 55270, 55271 and two each 1289D and 18413, in place of 18430.....
198D	5021	Shuttle Race Screw, in place of 171.....
*63749	—	Thread Take-up Cam, in place of 55302.....
39204	5028	" " " 63749 with 446c, in place of 18392.....
3072	5028	Thread Take-up Lever with 1819, in place of 18393.....
76c	5038	Thread Take-up Lever Hinge Screw, in place of 79.....
1819	5038	Thread Take-up Lever Roller and Stud, in place of 1822.....
55318	—	Throat Plate 18381 with 1698c, 17828, 50018F and 55317, in place of 55301.....

MACHINE No. 69-17

FOR STITCHING TWO OR FOUR-HOLE GROOVED BUTTONS ON MEN'S AND BOYS' CLOTHING. MAKES TWO SEPARATE BARS IN FOUR-HOLE BUTTONS; NO CROSS STITCHES BETWEEN THE BARS. AFTER THE FIRST BAR IS COMPLETED AND THE THREAD CUT, THE CLAMP AUTOMATICALLY BRINGS THE BUTTON INTO POSITION FOR THE SECOND BAR. MAKES EIGHTEEN STITCHES, INCLUDING THREE TYING STITCHES, TO EACH BAR.

This Machine is the same as 69-5
with the following exceptions:

NO.	PLATE	NAME
55308	—	Feed Cam with two each 1192c, 17874 and four 190D, in place of 18395.....
39211	5005	Feed Cam Driving Worm with 1441c and 1442c, in place of 18415.....
39212	5002	Feed Cam Driving Worm Wheel with 453c, in place of 17797.....

NO.	PLATE	NAME
217D	3731	Belt Cover Screw.....
39222	5001	" Shifter.....
39223	5008	" " Clamp.....
1255D	5021	" " " Screw.....
63811	7205	Clamp Arm (lower) with two 17992.....
17992	3740	" " " Hook.....
63812	7205	" " (upper).....
39333	3761	" " Bracket.....
39336	3761	Clamp Arm Bracket (adjustable) complete, Nos. 129J, 1178J, 1300D, 1654C, 39333 to 39335 and 50048J.....
129J	3761	Clamp Arm Bracket Adjusting Screw.....
39334	3761	" " " Hinge Block.....
1300D	3761	" " " " " Screw.....
50048J	3761	" " " " " Screw (eccentric).....
1654C	3761	Clamp Arm Bracket Hinge Screw Nut.....
17958	3733	" " Lifter with 17866.....
190D	3710	" " " Screw.....
9330	3740	" " Pin.....
1178J	3761	" " Screw.....
39335	3761	" " " Plate.....
18490	—	Clamp complete, Nos. 1654C, 9330, 18365, 18367, 39304, 39336, 63811 and 63812.....
4292	5002	Crank Connecting Rod with 4349 and two 158E.....
*4349	—	Crank Connecting Rod Cap.....
158E	3724	" " " " " Screw.....
375C	3724	" " " " " Hinge Screw.....
1518E	3718	" " " " " Nut.....
*55269	—	Cylinder.....
18388	5008	" Block.....
1300D	3748	" " Screw.....
18427	5001	" End Cover with 18428, 18444 and three 4604.....
18428	5008	Cylinder End Cover Bracket.....
18444	5008	" " " " " Hinge Pin.....
4604	5008	" " " " " Rivet.....
18379	5008	" " " " " Spring.....
217D	3731	" " " " " Screw.....
17724	5001	Face Plate.....
*63736	—	" " 17724 with 2105.....
17725	—	Face Plate complete, Nos. 448C, 600C, 1560C, 2103, 2107, 2124, 2127, 63736 and two each 233D and 2102.....
164D	3724	Face Plate Screw.....
2107	3722	" " Thread Guard.....

NO.	PLATE	NAME
233D	3722	Face Plate Thread Guard Screw.....
18353	5006	Feed Across Connection with 18354 and two 175E.....
*18354	—	Feed Across Connection Cap.....
175E	5021	" " " " " Screw.....
18355	5008	" " Knuckle Joint.....
1184C	5008	" " " " " Hinge Screw.....
18356	5006	" " Regulator with 1952.....
1187E	5008	" " " " " Adjusting Stud.....
1676C	5008	" " " " " " Nut.....
17738	5008	" " " " " " " Washer.....
17739	5008	Feed Across Regulator Adjusting Stud Sleeve.....
18357	5008	Feed Across Regulator Hinge Stud.....
690D	3748	" " " " " " " Clamp- ing Screw.....
1952	5008	Feed Across Regulator Roller and Stud.....
18358	5002	" " Shaft.....
18359	5008	" " " " " Collar with two 200F.....
200F	5008	" " " " " Set Screw.....
18421	5009	" " " " " Crank (back) with 160E and 200C.....
18456	5016	Feed Across Shaft Crank (back) Ball Stud.....
200C	5008	" " " " " " " " " Set Screw.....
160E	5008	Feed Across Shaft Crank (back) Clamping Screw.....
18362	5007	Feed Across Shaft Crank (front) with 160E and 18363.....
160E	5008	Feed Across Shaft Crank (front) Clamping Screw.....
18363	5007	Feed Across Shaft Crank (front) Stud.....
18364	5007	" " " " " " " " " Slide Block.....
17766	—	Feed Cam with two each 1192C, 17874 and four 190D.....
39211	5005	Feed Cam Driving Worm with 1441C and 1442C.....
1442C	5021	Feed Cam Driving Worm Position Screw.....
1441C	5021	" " " " " Set Screw.....
39212	5002	" " " " " Wheel with 453C.....
3012	3722	" " " " " " Pin.....
453C	5007	" " " " " " " Set Screw.....
18384	5007	" " Pin.....
1192C	3724	" " Set Screw.....
18416	5004	" " Shaft.....

NO.	PLATE	NAME
50018f	5021	Knife Holder Pinion Stud Bracket Screw
1698c	5021	" " " " " "
		Nut
1198c	5015	Knife Screw
17829	5015	" Thread Holder
17830	5015	" " " Position Pin
17831	5002	Needle Bar with 237f
39203	3718	" " Connecting Link
377c	3718	" " " " Hinge Screw
1518E	3718	" " " " " "
		Nut
21629	3718	Needle Bar Connecting Stud with 155c ..
155c	3718	" " " " Set Screw ..
39350	5029	" " Thread Nipper Driving Lever ✓ (adjustable) with 39351 and two 335d
39351	3759	Needle Bar Thread Nipper Driving Lever Extension
335d	3759	Needle Bar Thread Nipper Driving Lever Extension Screw
1196c	3721	Needle Bar Thread Nipper Driving Lever Hinge Screw
39352	5029	Needle Bar Thread Nipper Driving Lever Spring
17834	3718	Needle Bar Thread Nipper Lever with 17835
17835	3718	Needle Bar Thread Nipper Lever Bushing
1200d	3718	" " " " " Hinge Screw
39276	5009	Needle Bar Thread Nipper Lever Spring ✓
1329d	5009	" " " " " " ✓ Screw
17837	5019	Needle Bar Thread Nipper Rod
17838	3718	" " " " " Adjusting Stud
1651E	5021	Needle Bar Thread Nipper Rod Adjusting Stud Lock Nut
17839	3718	Needle Bar Thread Nipper Rod Arm with 196f
196f	3718	Needle Bar Thread Nipper Rod Arm Set Screw
17840	5001	Needle Bar Thread Nipper Rod Support
190d	3710	" " " " " "
		Screw
237f	3724	Needle Set Screw
6022	5001	Oscillating Rock Shaft (steel) with 4784
16806	—	Oscillating Rock Shaft complete, Nos. 6022 and 56812

NO.	PLATE	NAME
3052	3711	Oscillating Rock Shaft Hinge Pin
56812	—	" " " " " 3 0 5 2 with 1513j
1513j	3724	Oscillating Rock Shaft Hinge Pin Nut ..
4784	5009	" " " Oil Pad
6023	5028	" Shaft
18386	—	" " Crank
18387	5017	Oscillating Shaft Crank complete, Nos. 237f, 1519e, 15171 and 18386
2049	5017	Oscillating Shaft Crank Pin
237f	5017	" " " Set Screw
15170	5017	" " " Slide Block
229d	5017	" " " " Cap Screw
12424	5017	Oscillating Shaft Crank Slide Block Cap Screw Washer
1035c	5017	Oscillating Shaft Crank Slide Block Screw Stud
1519e	5017	Oscillating Shaft Crank Slide Block Screw Stud Nut
15171	5017	Oscillating Shaft Crank Slide Block com- plete, Nos. 229d, 1035c, 12424 and 15170
2058	5002	Presser Bar
17841	3718	" " Collar with two 196f
196f	3718	" " " Set Screw
17842	3718	" " Guide Bracket with 453c
453c	5007	" " " Set Screw
17843	5006	" " Lifting Lever
17844	5006	" " " " Bracket
164e	3724	" " " " " Screw ..
1201c	5021	" " " " Hinge Screw ..
17845	5019	" " " " Rod
17846	—	" " " " " Chain ..
8414	5001	" " Spring
17941	5003	Pulley (loose) 2 1/4 in. diam.
17848	5003	" " Bushing
2269	3722	" " " Position Pin
1202d	3724	" " Cap Screw
17942	5003	" (tight) 2 1/4 in. diam., with 2269 ..
2022	3722	" " Pin
17955	—	Pulleys complete, Nos. 1202d, 1206c, 17848, 17854, 17941 and 17942
2073	3702	Shuttle Bobbin
2211	3702	" " Retaining Spring
2212	3702	" " " " Rivet ..

NO	PLATE	NAME
*39295	—	Shuttle Body with 398E, 2082, 2084, 2211 and two 2212.
*2075	—	Shuttle Cover.
*44001	—	" " 2075 with 112D, 466H, 2078, 2080, 2086 and 2090.
2076	3702	Shuttle Cover Hinge Pin.
2078	3702	" Delivery Eye Thread Guard.
2080	3702	" " " " " Rivet
2082	3702	" Main Spring.
398E	3702	" " Screw.
2084	3702	" " Steady Pin.
466H	3702	" Tension Regulating Screw.
2086	3702	" " Spring.
2090	3702	" " Plate.
112D	3702	" " Screw.
39296	3702	Shuttle complete, Nos. 2073, 2076, 39295 and 44001.
39487	3702	Shuttle Driver with two 457c.
2049	3702	" " Pin.
457c	3702	" " Set Screw.
55270	—	" Race Body.
55271	5032	" " Ring.
18413	5018	" " Spring.
1289D	5018	" " " " Screw.
55272	5032	Shuttle Race complete, Nos. 55270, 55271 and two each 1289D and 18413.
198D	5021	Shuttle Race Screw.
17853	5003	Starting Lever.
1262c	5021	" " Hinge Screw.
1662c	5021	" " " " Nut.
17886	5019	" " Pitman.
17854	3721	Stop Cam.
17855	3721	" " Interlocking Rod.
18492	5028	" " " " Case with 18443 and two 193F.
*55285	—	Stop Cam Interlocking Rod Case 18492 with 1318D, 17855, 17863, 17864, 39222, 39223 and two 1255D.
39346	5028	Stop Cam Interlocking Rod Case Bracket
*55304	—	Stop Cam Interlocking Rod Case Bracket complete, Nos. 1182E, 1196c, 1204E, 1254c, 1262c, 1508E, 1662c, 17853, 17859, 17861, 17862, 17872, 17873, 39346, 55285 and two 898D.
18493	—	Stop Cam Interlocking Rod Case Bracket 55304 with 39343, 39344 and two 1186D

NO	PLATE	NAME
16532	3722	Stop Cam Interlocking Rod Case Bracket Dowel Pin.
1343E	5021	Stop Cam Interlocking Rod Case Bracket Screw.
1204E	3721	Stop Cam Interlocking Rod Case Hinge Screw.
17859	5003	Stop Cam Interlocking Rod Case Socket Joint.
898D	3721	Stop Cam Interlocking Rod Case Socket Joint Cap Screw.
39343	5028	Stop Cam Interlocking Rod Case Spring (flat).
430c	3759	Stop Cam Interlocking Rod Case Spring Adjusting Screw.
1520E	3759	Stop Cam Interlocking Rod Case Spring Adjusting Screw Nut.
39344	3759	Stop Cam Interlocking Rod Case Spring Bracket with 430c and 1520E.
1186D	5021	Stop Cam Interlocking Rod Case Spring Bracket Screw.
17861	3721	Stop Cam Interlocking Rod Case Stop Stud.
1254c	5021	Stop Cam Interlocking Rod Case Stop Stud Screw Bushing.
1508E	5021	Stop Cam Interlocking Rod Case Stop Stud Screw Bushing Lock Nut.
17862	3721	Stop Cam Interlocking Rod Case Stop Stud Spring.
18443	5015	Stop Cam Interlocking Rod Case Wearing Block.
193F	5015	Stop Cam Interlocking Rod Case Wearing Block Screw.
17863	3721	Stop Cam Interlocking Rod Spring.
17864	3721	" " " " Stop.
1318D	3748	" " " " " Screw.
3012	3722	" " Pin.
1206c	3721	" " Screw.
2102	3722	Tension Disc.
1560c	3722	" Regulating Thumb Nut.
600c	3722	" Screw Stud.
448c	3722	" " Set Screw.
2103	3722	" Spring.
2105	3722	" Thread Guard.
*63749	—	Thread Take-up Cam.
39204	5028	" " " 63749 with 446c.
3012	3722	" " " Pin.
446c	3724	" " " Set Screw.

NO.	PLATE	NAME
3072	5028	Thread Take-up Lever with 1819.....
76c	5038	" " " Hinge Screw.....
1819	5038	" " " Roller and Stud..
2124	3722	" " Spring.....
2127	3722	" " " Regulator Plate
233D	3722	" " " " " "
		Adjusting Screw.....
17865	3710	Thread Wiper Body.....
1207D	3710	" " " Hinge Screw.....
17866	3710	" " " Hook.....
17867	3710	" " " Support.....
641c	5021	" " " Set Screw...
17868	3710	" " " Wire.....
337D	3718	" " " " Screw.....
17869	3710	" " " " Washer..
18381	5020	Throat Plate with 17871 and two 1208D..
55318	—	" " 18381 with 1698c, 17828, 50018f and 55317.....
17871	5020	Throat Plate Needle Hole Bushing.....
1208D	5020	" " " " Screw.....
691f	5015	" " " Screw.....
17872	3721	Trip Lever.....
1196c	3721	" " Hinge Screw.....
17873	3721	" " Spring.....
1182E	3705	" " " Screw.....
17874	5009	Tripping Point.....
190D	3710	" " " Screw.....

LIST OF PARTS COMPLETE FOR

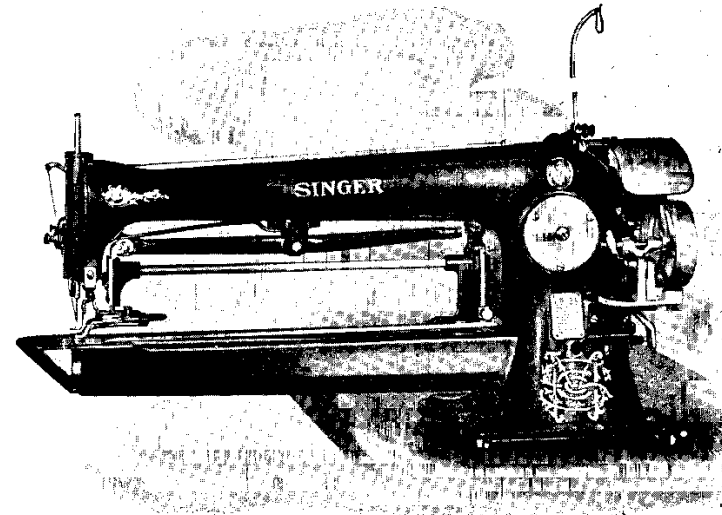

MACHINE No. 69-25

FOR SEWING TWO-HOLE BUTTONS ON SHIRTS AFTER THEY ARE LAUNDERED. CENTRAL BOBBIN. MAKES ELEVEN CROSS AND THREE TYING STITCHES. CLEAR WORKING SPACE FROM NEEDLE TO BASE OF CLAMP, 17 INCHES.

NO.	PLATE	NAME
*18495	—	Arm and Cylinder (solid) with 4449, 55217 and three 1177D.....
18496	5033	Arm Shaft.....
18497	5029	" " Bushing (back).....
50333c	5042	" " " " Adjusting Screw
1520E	3724	" " " " " "
		Nut.....
*4449	—	Arm Shaft Bushing (front).....
18498	5033	Belt Cover.....
39290	5001	" " Bracket with 184E and 17741..
184E	5021	" " " Screw Stud.....

NO.	PLATE	NAME
17741	5008	Belt Cover Bracket Stud
217D	3731	" " Screw
39222	5001	" Shifter
39223	5008	" " Clamp
1255D	5021	" " " Screw
17706	3704	Button Clamp (left) with 17723
17707	3704	" " (right) with 17723
18499	5034	" " Arm with 17720
18500	5034	" " Head with two 641c
55201	5034	" " " Plate
217D	3731	" " " " Screw
641c	5034	" " " " Set Screw
55202	—	" " " " Support
55203	5034	" " " " " 55202 with 55204
217D	3731	Button Clamp Head Support Screw
55204	5034	" " " " Stud
1175J	3704	" " Hinge Screw
55276	—	" " Lifting Lever with 910c
55206	5029	" " " " Bracket with 1143c
146D	5021	Button Clamp Lifting Lever Bracket Screw
55207	5037	Button Clamp Lifting Lever Hinge Pin 910c 5021
55277	—	Set Screw
1143c	5021	Button Clamp Lifting Lever Spring .. " " " " " Set Screw
55209	5033	Button Clamp Shaft
55210	5035	" " " Bracket with two 641c 181D 5021 " " " " Screw
641c	5034	" " " " Set Screw
55211	5035	" " Shank with 1993
1993	5038	" " " Roller and Stud
236K	5038	" " " " Screw
17716	3705	" " Spreader
17717	3705	" " " Lever
50237K	3705	" " " " Hinge Screw
1180J	3705	" " " " Locking Thumb Screw
17718	3705	Button Clamp Spreader Lever Locking Thumb Screw Washer
1182J	3705	Button Clamp Spreader Screw
39243	3748	" " " Spring
217K	3731	" " " " Screw
17720	3705	" " " " Steady Pin

NO.	PLATE	NAME
55212	5034	Button Clamp Spring
17720	3705	" " " Steady Pin
17722	3705	" " " Stop with two 17720
1183D	3705	" " " Screw
17723	3704	" " Stud
55213	—	Button Clamp (universal) complete, Nos. 217K, 1180J, 1182J, 17706, 17707, 17716 to 17718, 17722, 18499, 39243, 50237K, 55211, 55212, two each 1175J, 1183J and three 236K
4292	5002	Crank Connecting Rod with 4349 and two 158E
*4349	—	Crank Connecting Rod Cap
158E	3724	" " " " Screw
375c	3724	" " " " Hinge Screw
1518E	3718	" " " " " Nut
55214	5036	Cylinder Block
1177D	3710	" " " Screw
18427	5001	" End Cover with 18428, 18444 and three 4604
18428	5008	Cylinder End Cover Bracket
18444	5008	" " " " Hinge Pin
4604	5008	" " " " Rivet
18379	5008	" " " Spring
217D	3731	" " " " Screw
55215	5033	" Lower Cover
401D	5038	" " " Screw
55273	5029	Face Plate
55274	—	Face Plate complete, Nos. 448c, 600c, 1560c, 2103, 2105, 2107, 2124, 2127, 55273 and two each 233D and 2102
164D	3724	Face Plate Screw
2107	3722	" " Thread Guard
233D	3722	" " " " Screw
55225	—	Feed Cam with two 1192c, three 17874 and six 190D
18415	5007	Feed Cam Driving Worm with 1441c and 1442c
1442c	5021	Feed Cam Driving Worm Position Screw ..
1441c	5021	" " " " Set Screw
17797	5004	" " " " Wheel with 453c 3012 3722 " " " " Pin
453c	5007	" " " " " Set Screw
18384	5007	" " Pin
1192c	3724	" " Set Screw
55216	5035	" " Shaft
*55217	—	" " " Flanged Bushing

NO.	PLATE	NAME
1198c	5015	Knife Screw
17829	5015	" Thread Holder
17830	5015	" " " Position Pin
55241	5035	Needle Bar with 237F
39203	3718	" " Connecting Link
377c	3718	" " " " Hinge Screw
1518E	3718	" " " " " "
		Nut
55275	5036	Needle Bar Connecting Stud with two 175D
	175D	5021 Needle Bar Connecting Stud Clamping Screw
39350	5029	Needle Bar Thread Nipper Driving Lever (adjustable) with 39351 and two 335D
39351	3759	Needle Bar Thread Nipper Driving Lever Extension
	335D	3759 Needle Bar Thread Nipper Driving Lever Extension Screw
	1196c	3721 Needle Bar Thread Nipper Driving Lever Hinge Screw
39352	5029	Needle Bar Thread Nipper Driving Lever Spring
17834	3718	Needle Bar Thread Nipper Lever with 17835
17835	3718	Needle Bar Thread Nipper Lever Bushing
	1200D	3718 " " " " " Hinge Screw
55242	5036	Needle Bar Thread Nipper Lever Spring
	662D	5036 " " " " " " Screw
55243	5033	Needle Bar Thread Nipper Rod
17838	3718	" " " " " Adjusting Stud
	1651E	5021 Needle Bar Thread Nipper Rod Adjusting Stud Lock Nut
17839	3718	Needle Bar Thread Nipper Rod Arm with 196F
	196F	3718 Needle Bar Thread Nipper Rod Arm Set Screw
17840	5001	Needle Bar Thread Nipper Rod Support
	190D	3710 " " " " " " Screw
	237F	3724 Needle Set Screw
6022	5001	Oscillating Rock Shaft (steel) with 4784
*55278	—	Oscillating Rock Shaft complete, Nos. 1513r, 6022 and 6489
6489	5001	Oscillating Rock Shaft Hinge Pin

NO.	PLATE	NAME
1513j	3724	Oscillating Rock Shaft Hinge Pin Nut
4784	5009	" " " Oil Pad
55244	5033	" Shaft
55245	—	" " Crank
55246	5036	Oscillating Shaft Crank complete, Nos. 1519E, 15171, 55245 and two 1253c
	1253c	5038 Oscillating Shaft Crank Set Screw
15170	5017	" " " Slide Block
	229D	5017 " " " " Cap Screw
12424	5017	Oscillating Shaft Crank Slide Block Cap Screw Washer
1035c	5017	Oscillating Shaft Crank Slide Block Screw Stud
1519E	5017	Oscillating Shaft Crank Slide Block Screw Stud Nut
15171	5017	Oscillating Shaft Crank Slide Block complete, Nos. 229D, 1035c, 12424 and 15170
17941	5003	Pulley (loose) 2 1/8 in. diam
17848	5003	" " Bushing
2269	3722	" " " Position Pin
1202D	3724	" " Cap Screw
17942	5003	" (tight) 2 1/8 in. diam., with 2269
2022	3722	" " Pin
17955	—	Pulleys complete, Nos. 1202D, 1206c, 17848, 17854, 17941 and 17942
2996	5017	Shuttle Bobbin
15140	5017	" " Case Latch
2973	5017	" " " Lever
2974	5017	" " " " Fulcrum Pin
2975	5017	Shuttle Bobbin Case Latch Spring
	592E	5017 " " " Stop Screw
15141	—	" " " Hinge, Nos. 2973, 2974 and 15140
15027	5017	Shuttle Bobbin Case Position Finger
2523	5017	" " " " Rivet
15277	5017	Shuttle Bobbin Case complete, Nos. 591F, 592E, 2523, 2975, 15027, 15141 and 15278
21562	5017	Shuttle Body
	591F	5017 " Tension Regulating Screw
15278	5017	" " Spring
21561	5017	Shuttle, 1 1/8 in. diam., Nos. 2996, 15277 and 21562
*2542	—	Shuttle Driver

NO.	PLATE	NAME
2441	5017	Shuttle Driver 2542 with two 462c.....
2049	5017	" " Pin.....
462c	5017	" " Set Screw.....
18411	—	" Race Body.....
21623	5018	" " Cap.....
662d	5018	" " " Screw.....
2523	5018	" " " Steady Pin.....
18429	5018	" " " Ring.....
18413	5018	" " " Spring.....
1289d	5018	" " " " Screw.....
18430	5018	Shuttle Race (flexible) complete, Nos. 662d, 2523, 18411, 18429, 21623 and two each 1289d and 18413.....
171d	5018	Shuttle Race Screw.....
17853	5003	Starting Lever.....
1262c	5021	" " Hinge Screw.....
1662c	5021	" " " " Nut.....
17854	3721	Stop Cam.....
17855	3721	" " Interlocking Rod.....
18492	5028	" " " " Case with 18443 and two 193f.....
*55285	—	Stop Cam Interlocking Rod Case 18492 with 1318d, 17855, 17863, 17864, 39222, 39223 and two 1255d.....
39346	5028	Stop Cam Interlocking Rod Case Bracket.....
55247	—	Stop Cam Interlocking Rod Case Bracket complete, Nos. 181e, 357c, 1182e, 1196c, 1204e, 1254c, 1262c, 1508e, 1650c, 1662c, 17853, 17859, 17861, 17862, 17872, 17873, 39346, 55248, 55285 and two 898d.....
16532	3722	Stop Cam Interlocking Rod Case Bracket Dowel Pin.....
1343e	5021	Stop Cam Interlocking Rod Case Bracket Screw.....
1204e	3721	Stop Cam Interlocking Rod Case Hinge Screw.....
17859	5003	Stop Cam Interlocking Rod Case Socket Joint.....
898d	3721	Stop Cam Interlocking Rod Case Socket Joint Cap Screw.....
55248	5035	Stop Cam Interlocking Rod Case Spring (flat).....
357c	5038	Stop Cam Interlocking Rod Case Spring Adjusting Screw.....
1650c	5038	Stop Cam Interlocking Rod Case Spring Adjusting Screw Nut.....

NO.	PLATE	NAME
181d	5021	Stop Cam Interlocking Rod Case Spring Screw.....
17861	3721	Stop Cam Interlocking Rod Case Stop Stud.....
1254c	5021	Stop Cam Interlocking Rod Case Stop Stud Screw Bushing.....
1508e	5021	Stop Cam Interlocking Rod Case Stop Stud Screw Bushing Lock Nut.....
17862	3721	Stop Cam Interlocking Rod Case Stop Stud Spring.....
18443	5015	Stop Cam Interlocking Rod Case Wearing Block.....
193f	5015	Stop Cam Interlocking Rod Case Wearing Block Screw.....
17863	3721	Stop Cam Interlocking Rod Spring.....
17864	3721	" " " " Stop.....
1318d	3748	" " " " " Screw.....
3012	3722	" " Pin.....
1206c	3721	" " Screw.....
2102	3722	Tension Disc.....
1560c	3722	" Regulating Thumb Nut.....
55249	5036	" Releasing Lever with 17835.....
17835	5036	" " " Bushing.....
102d	5036	" " " Connecting Screw.....
1200d	5036	" " " Hinge Screw.....
600c	3722	" Screw Stud.....
448c	3722	" " " Set Screw.....
2103	3722	" Spring.....
2105	3722	" Thread Guard.....
17748	3722	Thread Eyelet (top of arm).....
*55302	—	" Take-up Cam.....
18392	5003	" " " 55302 with 446c.....
3012	3722	" " " Pin.....
446c	3724	" " " Set Screw.....
18393	5002	" " " Lever with 1822.....
79c	5021	" " " Hinge Screw.....
1822	5021	" " " Roller and Stud.....
2124	3722	" " " Spring.....
2127	3722	" " " Regulator Plate.....
233d	3722	" " " " ".....
		Adjusting Screw.....
55250	5037	Thread Wiper Body.....
1175d	5037	" " " Hinge Screw.....
55251	5037	" " " Arm with 17866.....
17866	3710	" " " " Pin.....
1484f	5037	" " " " Screw.....
55252	5037	" " " " Support.....

NO.	PLATE	NAME
55253	5037	Thread Wiper Body Support Bracket with 55252.....
914F	5036	Thread Wiper Body Support Bracket Screw.....
39455	5037	Thread Wiper Body Wire.....
229D	5037	" " " " Screw.....
17869	3710	" " " " Washer..
18381	5020	Throat Plate with 17871 and two 1208D, for flat buttons.....
*55301	—	Throat Plate 18381 with 1698c, 17828, 50018F and 55296.....
17871	5020	Throat Plate Needle Hole Bushing.....
1208D	5020	" " " " Screw
691F	5015	" " Screw.....
17872	3721	Trip Lever.....
1196C	3721	" " Hinge Screw.....
17873	3721	" " Spring.....
1182E	3705	" " Screw.....
17874	5009	Tripping Point.....
190D	3710	" " Screw.....

CLAMPS

BUTTON CLAMPS (End Opening)

FOR 69-5 AND 69-6 MACHINES

NO.	PLATE	NAME
17926	3706	Button Clamp with 1220E and 17928....
17927	3706	" " Arm with 17714 and 63788
63788	7205	" " " Hook.....
17928	3706	" " Position Stud.....
17712	3710	" " Pressure Spring.....
17714	3704	" " " " Guide Block
1220E	3706	" " Screw Stud.....
17929	3706	" " Spring, for flat buttons...
17930	3706	" " " " stud back buttons.....
1208J	5020	Button Clamp Spring Screw.....
1656J	3706	" " Thumb Nut.....
17931	—	Button Clamp (end opening) complete, Nos. 17926, 17929 or 17930 and two 1208J.....
17932	—	Button Clamp (end opening) with Arm complete, Nos. 1656J, 17927 and 17931

BUTTON CLAMP (End Opening)

FOR 69-25 MACHINE

NO.	PLATE	NAME
17926	3706	Button Clamp with 1220E and 17928....
17928	3706	" " Position Stud.....
1220E	3706	" " Screw Stud.....
55255	5035	" " Shank with 1993.....
1993	5038	" " " Roller and Stud...
55256	5037	" " Spring.....
1208J	5020	" " Screw.....
1656J	3706	" " Thumb Nut.....
55257	—	Button Clamp (end opening) complete, Nos. 1208J, 1656J, 17926, 55255 and 55256.....

BUTTON CLAMP (Side Opening)

FOR 69-5 AND 69-6 MACHINES

NO.	PLATE	NAME
17933	3707	Button Clamp with 1220E and 17928....
17927	3706	" " Arm with 17714 and 63788
63788	7205	" " " Hook.....
17928	3706	" " Position Stud.....
17712	3710	" " Pressure Spring.....
17714	3704	" " " " Guide Block
1220E	3706	" " Screw Stud.....
17934	3707	" " Spring, for flat buttons...
17935	3707	" " " " stud back buttons.....
1208J	5020	Button Clamp Spring Screw.....
1656J	3706	" " Thumb Nut.....
17936	—	Button Clamp (side opening) complete, Nos. 17933, 17934 or 17935 and two 1208J.....
17937	—	Button Clamp (side opening) with Arm complete, Nos. 1656J, 17927 and 17936

CLAMP FOR HOOKS AND EYES

FOR 69-5 AND 69-6 MACHINES

NO.	PLATE	NAME
17906	3709	Clamp (left) with 23219.....
17907	3709	" (right).....
17908	3709	" Arm with 17714 and 63788.....
63788	7205	" " Hook.....

CLAMPS

NO.	PLATE	NAME
1175J	3704	Clamp Hinge Screw.....
17911	3709	" Hook Stop.....
1208J	5020	" " Screw.....
17712	3710	" Pressure Spring.....
17714	3704	" " Guide Block.....
1219J	3709	" Spreader Stud.....
1657J	3709	" " Thumb Nut.....
17718	3705	" " " " Washer.....
17909	3709	" " Spring.....
1182J	3705	" " " Screw.....
17910	3709	" Spring.....
1208J	5020	" " Screw.....
23219	3709	" " Steady Pin.....
17912	—	Clamp complete, for hooks and eyes, Nos. 1182J, 1219J, 1657J, 17718, 17906 to 17911 and two each 1175J and 1208J....

CLAMP FOR TYING FRENCH KNOTS

FOR 69-5 MACHINE

NO.	PLATE	NAME
17946	3729	Clamp with 17948.....
17947	3729	" Arm with 17714 and 63788.....
63788	7205	" " Hook.....
17948	3729	" Hinge Stud.....
17949	3729	" " " Pin.....
1263J	3729	" Leveling Thumb Screw.....
17950	3729	" " " " S t o p Bracket.....
220J	3729	Clamp Leveling Thumb Screw Stop Bracket Screw.....
17712	3710	Clamp Pressure Spring.....
17714	3704	" " " Guide Block.....
17951	3729	" Stretching Ring.....
1264J	3729	" " " Hinge Screw.....
17952	3729	" " " Spring.....
220J	3729	" " " Adjusting Screw.....
578K	3729	Clamp Stretching Ring Spring Screw.....
17953	—	Clamp complete, for tying French knots, Nos. 578K, 1263J, 17946, 17947, 17949 to 17952, two 1264J and three 220J....
17954	5014	Feed Plate.....
39205	5023	Guide with 460c.....
460c	5021	" Set Screw.....

ATTACHMENTS AND ACCESSORIES

NO.	PLATE	NAME
55258	5040	Button Tray with two wood screws 1 in. No. 10, for 69-25 Machine.....
18419	—	Cylinder Base Plate with two 453c, for 18424.....
55259	—	Cylinder Base Plate with two 453c, for 55260.....
18420	5005	Cylinder Base Plate Hinge Connection
18423	5005	" " " " "
		Hinge Pin.....
453c	5005	Cylinder Base Plate Hinge Connection Hinge Pin Set Screw.....
18424	5022	Cylinder Base Plate (hinged) complete, for all machines except 69-25, Nos. 18419, two each 18420, 18423, three wood screws 1¼ in. No. 12 and four 134D...
55260	5039	Cylinder Base Plate (hinged) complete for 69-25 Machine, Nos. 55259, two each 134D, 18420, 18423 and four wood screws 1¼ in. No. 12.....
134D	5005	Cylinder Base Plate Screw.....
41400	5023	Machine Rest Pin (wood).....
36565	4079	Oiler (copper plated) with 36566.....
36566	4079	" Spout, 9 in. long, with 120117.....
120117	5023	" " Washer (leather).....
11831	5023	Screw Driver (large).....
26026	5023	" " (machine).....
26485	5023	" " (shuttle tension).....
10875	5023	Wrench for 1518, 1520 and 1650.....
27662	5023	" " 1508.....
17905	5023	" " 1178, 1654 and 1676.....
22003	5023	" " 1651.....

BOBBIN WINDERS

BOBBIN WINDER

(SWINGING AUTOMATIC, LEFT HAND)

FOR 2996

FOR 69-5 TO 69-15, 69-17 AND 69-18 MACHINES

NO.	PLATE	NAME
41598	5041	Base with 27916 and two 28084.....
1186c	3781	" Screw.....
15072	5009	Bobbin Position Pin.....

NO.	PLATE	NAME
41715	5023	Bracket.....
129E	3761	" Screw.....
27916	3781	Brake (leather).....
28084	3781	" Rivet.....
27321	5041	Frame.....
50356D	5042	" Hinge Screw.....
1620J	5042	" " " Nut.....
41825	3781	" Spring.....
41600	5041	Pulley with 155c.....
155c	5038	" Set Screw.....
27538	5041	Spindle with 15072.....
27328	5041	Stop Latch.....
35D	3724	" " Hinge Screw.....
60769	3780	Tension Bracket.....
60770	3780	Tension Bracket complete, Nos. 419E, 1562J, 8422, 9780, 43808, 60769 and two 2455.....
9780	3781	Tension Bracket Position Stud.....
161D	3724	" " Screw.....
2455	3781	" Disc.....
1562J	3722	" Regulating Thumb Nut.....
419E	5042	" Screw Stud.....
43808	5042	" Spring.....
8422	3781	" Thread Guide.....
41604	5041	Bobbin Winder, Nos., 35D, 1620J, 27321, 27328, 27538, 41598, 41600, 41825 and 50356D.....
41716	—	Bobbin Winder (swinging automatic, left hand) complete, Nos. 161D, 41604, 60770 and two 1186c.....

BOBBIN WINDER

(SWINGING AUTOMATIC, LEFT HAND)

FOR 2073

FOR 69-16 AND 69-19 MACHINES

This Bobbin Winder is the same as No. 41716
with the following exceptions:

NO.	PLATE	NAME
27305	3781	Spindle, in place of 27538.....
27326	3781	Stop Latch, in place of 27328.....
41713	3780	Bobbin Winder, Nos. 35D, 1620J, 27305, 27321, 27326, 41598, 41600, 41825 and 50356D, in place of 41604.....

NO.	PLATE	NAME
41714	—	Bobbin Winder (swinging automatic, left hand) complete, Nos. 161D, 41713, 60770 and two 1186c.....

BOBBIN WINDER

(SWINGING AUTOMATIC, LEFT HAND)

FOR 2996

FOR 69-25 MACHINE

NO.	PLATE	NAME
41598	5041	Base with 27916 and two 28084.....
1186c	5021	" Screw.....
15072	5009	Bobbin Position Pin.....
41599	5041	Bracket.....
1177D	5038	" Screw.....
27916	3781	Brake (leather).....
28084	3781	" Rivet.....
27321	5041	Frame.....
50356D	5042	" Hinge Screw.....
1620J	5042	" " " Nut.....
41825	3781	" Spring.....
41600	5041	Pulley with 155c.....
155c	5038	" Set Screw.....
27538	5041	Spindle with 15072.....
27328	5041	Stop Latch.....
35D	3724	" " Hinge Screw.....
41601	5041	Tension Bracket with 624c.....
41602	—	Tension Bracket complete, Nos. 5989, 10145, 41601 and 41603.....
1186c	5021	Tension Bracket Screw.....
2455	3722	" Disc.....
1562J	3722	" Regulating Thumb Nut.....
418E	3722	" Screw Stud.....
10141	3722	" Spring.....
10145	5016	" Thread Guide.....
5989	—	Tension complete, Nos. 418E, 1562J, 10141 and two 2455.....
41569	5037	Thread Eyelet.....
41603	5041	" " Rod with 41569.....
624c	5038	" " " Set Screw.....
41604	5041	Bobbin Winder, Nos. 35D, 1620J, 27321, 27328, 27538, 41598, 41600, 41825 and 50356D.....
41605	—	Bobbin Winder (swinging automatic, left hand) complete, Nos. 41599, 41602, 41604, two 1177D and three 1186c.....

PROTECTOR

FOR ALL MACHINES EXCEPT 69-25

NO.	PLATE	NAME
39489	7008	Arm with 39490.....
160c	7009	" Clamping Screw.....
39490	—	Blade.....
39491	7008	Bracket with two each 426c and 448c.....
426c	7009	" Adjusting Screw.....
50351D	7009	" Screw.....
39492	7009	Crank with 160c.....
39493	7009	" Bracket with 1120c and two 454c.....
454c	7009	" Set Screw.....
52598	7009	" Hinge Stud.....
1120c	7009	" " " Set Screw.....
39494	7008	Rod.....
15261	7009	" Collar with 237F.....
237F	7009	" Set Screw.....
39495	7009	" Connection.....
176D	7009	" " Screw.....
1099F	7009	" Screw Stud.....
39496	7008	" Sleeve.....
448c	7009	" " Set Screw.....
39497	7009	" Spring.....
15261	7009	" Collar with 237F.....
237F	7009	" " " Set Screw.....
63753	—	Protector (front of needle) Nos. 1099F, 39489, 39491 to 39494, 39496, 39497, 52598 and two 15261.....
39498	—	Protector (front of needle) complete, Nos. 39495, 63753 and two each 176D and 50351D.....

STAND FOR ELECTRIC MOTOR

NO.	PLATE	NAME
46667	7219	Brace.....
748E	5042	" Screw.....
46522	7219	Leg.....
4881	7219	Motor Treadle.....
46614	7219	" " Bracket (left).....
1177E	3710	" " " " Screw.....
46615	7219	" " " " (right).....
1177E	3710	" " " " Screw.....
4879	5023	" " Chain Connecting Link.....
4882	5023	" " Shaft.....
4883	5023	" " Spring.....

STAND FOR ELECTRIC MOTOR

NO.	PLATE	NAME
46616	7219	Motor Treadle complete, Nos. 4879, 4881 to 4883, 46614 and 46615.....
4881	7219	Starting Treadle.....
46614	7219	" " Bracket (left).....
1177E	3710	" " " " Screw.....
46615	7219	" " " " (right).....
1177E	3710	" " " " Screw.....
4879	5023	" " Chain Connecting Link.....
4882	5023	" " Shaft.....
4883	5023	" " Spring.....
46616	7219	Starting Treadle complete, Nos. 4879, 4881 to 4883, 46614 and 46615.....
46617	7219	Treadle Support.....
46618	—	" " 46617 with two 46616 and four 1177E.....
780E	5042	Treadle Support Bolt with 1600E.....
1600E	5042	" " " Nut.....
25086	5023	Wrench.....
25285	—	Stand (iron work) complete, Nos. 25086, 46618, 46667, two each 780E, 46522 and four 748E.....

STARTING LEVER AND FOOT LIFTER PARTS

NO.	PLATE	NAME
17876	5022	Treadle with 443c, for 17884.....
4881	5040	" for 4885.....
39569	—	" Chain, 45 in. long, with 39575 and 39576, for foot lifter, for 69-25 Machine.....
13351	—	Treadle Chain, 46 in. to 55 in. long, with 56864 and 56865, for starting lever, for 69-25 Machine.....

NOTE: When ordering No. 13351, give
length required.

4879	5023	Treadle Chain Connecting Link for 4885
55266	5040	" " Guide Bracket with two 457c, for 55268.....
55262	5040	Treadle Chain Guide Bracket for 55265..
55267	5040	" " " Pulley for 55268..
39571	5040	" " " " " 55265..
55263	5005	" " " " Pin for 55268
457c	5038	" " " " " Set Screw for 55266.....

64 STARTING LEVER AND FOOT LIFTER PARTS

NO.	PLATE	NAME
1064D	5038	Treadle Chain Guide Pulley Screw for 55265.....
39575	5037	Treadle Chain Hook (lower) for 39569....
39576	5037	" " " (upper) for 39569....
56864	5042	" " " (large) for 13351....
56865	5042	" " " (small) for 13351....
55268	5040	Treadle Chain Guide complete, for foot lifter, for 69-25 Machine, Nos. 55266, two each 55263, 55267 and three wood screws 1¼ in. No. 14.....
55265	5040	Treadle Chain Guide complete, for starting lever, for 69-25 Machine, Nos. 55262 and two each 1064D, 39571 and wood screws 1¼ in. No. 12 R. H. B.....
17877	5000	Treadle Pitman Rod (lower).....
17878	5000	" " " (upper).....
17879	5000	" " " Clamp with two 161D.....
161D	3724	" " " Screw.....
17880	5000	Treadle Pitman complete for 17885, Nos. 17877 to 17879.....
17881	5005	Treadle Shaft for 17884.....
4882	5023	" " " 4885.....
443C	5042	" " Set Screw for 17876.....
17882	5005	" Spring for 17884.....
4883	5023	" " " 4885.....
17883	5022	" Stand for 17884.....
4884	5040	" " " 4885.....
17884	—	Treadle complete for 17885, Nos. 17876, 17881 to 17883 and two wood screws 1 in. No. 10.....
4885	5040	Treadle complete for 69-25 Machine, Nos. 4879, 4881 to 4884 and two wood screws 1 in. No. 16.....
17885	—	Treadle and Pitman complete for all machines except 69-25, Nos. 17880 and 17884.....

TABLE BELT GUIDES**TABLE BELT GUIDE**

FOR ALL MACHINES EXCEPT 69-25

NO.	PLATE	NAME
39218	5022	Belt Guide with two 168E.....
168E	5021	" " Set Screw.....
17892	5022	Bracket with two 153E.....

TABLE BELT GUIDES

65

NO.	PLATE	NAME
17893	5022	Pulley.....
39219	5022	" Shaft (long) with 17896.....
39220	5022	" " (short) with 17896.....
17896	5005	" " Plug.....
153E	5021	" " Set Screw.....
39221	—	Table Belt Guide complete, Nos. 17892, 39219, 39220, two each 17893, 39218 and three wood screws 1¼ in. No. 12.....

TABLE BELT GUIDE

FOR 69-25 MACHINE

NO.	PLATE	NAME
23536	5039	Belt Guide with two 168E.....
168E	5021	" " Set Screw.....
14229	5039	Bracket with 448C.....
23538	5039	Pulley.....
39708	5039	" Shaft with 858C.....
858C	5038	" " Oil Hole Plug Screw.....
448C	5038	" " Set Screw.....
39716	5039	Table Belt Guide (single, left) complete, Nos. 14229, 23536, 23538, 39708 and four wood screws 1¼ in. No. 12 R. H. B.....
39709	5039	Table Belt Guide (single, right) complete, Nos. 14229, 23536, 23538, 39708 and four wood screws 1¼ in. No. 12 R. H. B.....

THREAD UNWINDER

FOR TWO LARGE SPOOLS OR TWO LARGE CONES OF THREAD

NO.	PLATE	NAME
27623	2837	Spool Pin.....
155C	5038	" " Set Screw.....
41530	2837	" Rest.....
60455	—	" " 41530 with 1149C and two 155C.....
41531	—	" " 60455 with two 27623.....
1149C	5038	" " Set Screw.....
27940	2837	" Stand with 453C.....
41514	2837	" Weight, 4 in. diam., with 41515....
41515	5037	" " Centre Pin.....
27739	2837	Thread Cone (wood).....
41631	2837	" Guard with 208E and two 41569.....
41569	5037	" " Eyelet.....

NO.	PLATE	NAME
17920	5025	Knife Bar Driving Lever Lock Stud Stop Pin.....
39237	5006	Knife Cam Lever complete, Nos. 1174D, 19793, 39235 and 39236, use 39329.....
18375	5006	Knife Cam Lever Bracket for 1197D.....
1197D	3724	" " " Hinge Screw.....
1964	5015	" " " Roller and Stud.....
39236	5015	" " " Slide with 1964, for 39237, use 39460.....
1174D	3724	Knife Cam Lever Slide Screw.....
5944	5015	" " " " Steady Pin.....
17832	5001	Needle Bar Thread Nipper Driving Lever
17833	5001	" " " " " " " " Spring.....
17836	3718	Needle Bar Thread Nipper Lever Spring for 337.....
337D	3718	Needle Bar Thread Nipper Lever Spring Screw.....
17847	5024	Pulley (loose) 2½ in. diam.....
17849	5024	" (tight) 2½ in. diam., with 2269.....
15142	5027	Shuttle Bobbin Case complete for 21561, Nos. 591E, 592E, 2523, 2975, 15027, 15098 and 15141, use 15277.....
17850	—	Shuttle Driver with two 457c, for 69-16 Machine, use 39487.....
15098	5027	Shuttle Tension Spring for 15142.....
18377	5025	" Race Ring.....
18412	5026	" " " for 18414.....
18414	5026	Shuttle Race (flexible) complete for 18378, Nos. 662D, 2523, 18411, 18412, 21623 and two each 1289D and 18413.....
1203C	3724	Starting Lever Hinge Screw.....
17887	5022	" " Treadle for 17890.....
17943	3741	" " " with 196F and 443C, for 17945.....
17944	3741	Starting Lever Treadle Extension for 17945.....
17888	5022	Starting Lever Treadle Extension with 17889, for 17890.....
17889	3718	Starting Lever Treadle Extension Hook for 17888.....
160E	5008	Starting Lever Treadle Extension Screw...
196F	3718	" " " " Set Screw
17890	—	Starting Lever Treadle complete for 17891, Nos. 17881 to 17883, 17887, 17888 and two each 160E and wood screws 1 in. No. 10, use 17945.....

NO.	PLATE	NAME
17945	—	Starting Lever Treadle complete for 17891, Nos. 17881 to 17883, 17943, 17944 and two wood screws 1 in. No. 10.....
17891	—	Starting Lever Treadle and Pitman complete, Nos. 17880 and 17945.....
39202	5035	Stop Cam Interlocking Rod Case.....
39224	5024	" " " " " for 18425
18440	5003	" " " " " with 18443 and two 193F, for 18442 and 18458
17857	5024	Stop Cam Interlocking Rod Case Bracket for 18425.....
18441	5003	Stop Cam Interlocking Rod Case Bracket for 18442.....
39288	5003	Stop Cam Interlocking Rod Case Bracket for 18458.....
18425	—	Stop Cam Interlocking Rod Case Bracket complete for all machines except 69-8 and 69-25, Nos. 1182E, 1196C, 1204E, 1254C, 1262C, 1318D, 1508E, 1662C, 17853, 17855, 17857, 17859 to 17864, 17872, 17873, 18418, 39222 to 39224 and two each 898D, 1255D and 1300D, use 18442.....
18442	—	Stop Cam Interlocking Rod Case Bracket complete for all machines except 69-8 and 69-25, Nos. 1182E, 1196C, 1204E, 1254C, 1262C, 1318D, 1508E, 1662C, 17853, 17855, 17859 to 17864, 17872, 17873, 18440, 18441, 39222, 39223 and two each 898D and 1255D.....
18458	—	Stop Cam Interlocking Rod Case Bracket complete for 69-8 Machine, Nos. 1182E, 1196C, 1204E, 1254C, 1262C, 1318D, 1508E, 1662C, 17853, 17855, 17859 to 17864, 17872, 17873, 18440, 18441, 39222, 39223 and two each 898D and 1255D.....
18380	5019	Stop Cam Interlocking Rod Case Extension for 1255.....
18418	5019	Stop Cam Interlocking Rod Case Extension for 1300, for 18425.....
1255D	5021	Stop Cam Interlocking Rod Case Extension Screw for 18380.....
1300D	3748	Stop Cam Interlocking Rod Case Extension Screw for 18418.....
17860	3721	Stop Cam Interlocking Rod Case Spring

OBSOLETE PARTS

NO.	PLATE	NAME
25350	3722	Table Belt Guide Pulley Cotter Pin for 17897.....
17894	5022	Table Belt Guide Pulley Shaft (long) with two 17896, for 17897.....
17895	5022	Table Belt Guide Pulley Shaft (short) with two 17896, for 17897.....
11742	3710	Table Belt Guide Pulley Washer for 17897
17897	—	Table Belt Guide complete, Nos. 17892, 17894, 17895, two each 11742, 17893, 25350 and three wood screws 1¼ in. No. 12, use 39221.....
17748	3722	Thread Eyelet (top of arm).....
55261	—	Treadle Chain Guide Bracket with two 457c, for 55264.....
55264	—	Treadle Chain Guide complete, for foot lifter, for 69-25 Machine, Nos. 55261, two each 39571, 55263 and three wood screws 1¼ in. No. 14, use 55268.....

NUMERICAL LIST OF PARTS
FOR
MACHINES
Nos. 69-5 to 69-19 and 69-25

NUMERICAL LIST OF PARTS

NO.	PLATE	NAME
35D	3724	Bobbin Winder Stop Latch Hinge Screw for 41604 and 41713
76C	5038	Thread Take-up Lever Hinge Screw for 69-16 and 69-19 Machines
79C	5021	Thread Take-up Lever Hinge Screw for all machines except 69-16 and 69-19
86D	5009	Hand Stop Lever Hinge Screw for 69-8 Machine
90J	3738	Clamp Arm (lower) Hinge Screw for 18452
90J	3738	“ “ (upper) Hinge Screw for 18452
93F	5009	Hand Stop Lever Rod Connection Screw for 69-8 Machine
102D	5036	Tension Releasing Lever Connecting Screw for 69-25 Machine
112D	3702	Shuttle Tension Spring Screw for 44001
129E	3761	Bobbin Winder Bracket Screw for 41714 and 41716
129J	3761	Clamp Arm Bracket Adjusting Screw for 39336
134D	5005	Cylinder Base Plate Screw for 18424 and 55260
145E	5038	Field Regulator Bracket Screw for 69-25 Machine
146D	5021	Button Clamp Lifting Lever Bracket Screw for 69-25 Machine
153E	5021	Table Belt Guide Pulley Shaft Set Screw for 17892
155C	5038	Bobbin Winder Pulley Set Screw for 41600
155C	3718	Needle Bar Connecting Stud Set Screw for 21629
155C	5038	Thread Unwinder Spool Pin Set Screw for 60455
158E	3724	Crank Connecting Rod Cap Screw for 4292
160E	5008	Feed Across Shaft Crank (back) Clamping Screw for 18360 and 18421
160E	5008	Feed Across Shaft Crank (front) Clamping Screw for 18362
160D	5008	Feed Regulator Bracket Cap Screw for 18369, 18469 and 55238
160C	7009	Protector Arm Clamping Screw for 39492
160E	5008	Starting Lever Treadle Extension Screw for 17890, obsolete
161D	3724	Bobbin Winder Tension Bracket Screw for 41714 and 41716

NUMERICAL LIST OF PARTS

NO.	PLATE	NAME
161D	3724	Treadle Pitman Rod Clamp Screw for 17879.....
164D	3724	Face Plate Screw.....
164E	3724	Presser Bar Lifting Lever Bracket Screw for 18351, 18439 and 18457.....
168E	5021	Table Belt Guide Belt Guide Set Screw for 23536 and 39218.....
171D	5018	Shuttle Race Screw for all machines except 69-16 and 69-19.....
175E	5021	Feed Across Connection Cap Screw for 18353.....
175D	5021	Needle Bar Connecting Stud Clamping Screw for 55275.....
176D	7009	Protector Rod Connection Screw for 39498
181D	3738	Arch Clamp Frame Screw for 18436, 18453, 18462 and 18483.....
181D	5021	Button Clamp Shaft Bracket Screw for 69-25 Machine.....
181E	5021	Stop Cam Interlocking Rod Case Spring Screw for 55247.....
181J	3738	Clamp Arm (lower) Bracket Screw for 18452.....
184E	5021	Belt Cover Bracket Screw Stud for 39290
190D	3710	Arch Clamp Foot Lifter Screw for 69-8, 69-9, 69-11, 69-14 and 69-16 Machines
190J	3710	Arch Clamp Foot Plate Screw for 18483
190D	3710	Button Clamp Lifter Screw for 69-5, 69-6, 69-15, 69-17 and 69-18 Machines.....
190D	3710	Clamp Arm Lifter Screw for 69-7, 69-12, 69-13 and 69-19 Machines.....
190D	3710	Clamp Arm (upper) Lifter Screw for 69-10 Machine.....
190D	3710	Knife Bar Connection Screw.....
190D	3710	“ “ Driving Lever Lock Stud Spring Screw for 17918 and 39297.....
190D	3710	Needle Bar Thread Nipper Rod Support Screw.....
190D	3710	Tripping Point Screw for 17766, 18395 to 18399, 18401 to 18406, 55225, 55308 and 55309.....
193F	5015	Stop Cam Interlocking Rod Case Wearing Block Screw for 18440 and 18492.....
196F	3718	Needle Bar Thread Nipper Rod Arm Set Screw for 17839.....
196F	3718	Presser Bar Collar Set Screw for 17841....
196F	3718	Starting Lever Treadle Extension Set Screw for 17943, obsolete.....

NUMERICAL LIST OF PARTS

NO.	PLATE	NAME
198D	5021	Shuttle Race Screw for 69-16 and 69-19 Machines.....
200C	5008	Feed Across Shaft Crank (back) Ball Stud Set Screw for 18360 and 18421.....
200F	5008	Feed Across Shaft Collar Set Screw for 18359.....
217J	3731	Arch Clamp Foot Plate Screw for 18436, 18449, 18453 and 18462.....
217J	3731	Arch Clamp Foot Spring Screw for 18436, 18449 and 18462.....
217J	3731	Arch Clamp Foot Spring Screw (lower) for 18453.....
217D	3731	Belt Cover Screw.....
217D	3731	Button Clamp Head Plate Screw for 69-25 Machine.....
217D	3731	Button Clamp Head Support Screw for 69-25 Machine.....
217K	3731	Button Clamp Spreader Spring Screw for 55213.....
217D	3731	Cylinder End Cover Spring Screw.....
217D	3731	Knife Bar Cap Screw.....
207J	5008	Button Clamp Spreader Spring Screw for 18467 and 39249, obsolete.....
208E	5038	Thread Unwinder Thread Guard Screw for 41631.....
219K	5030	Arch Clamp Foot Screw for 18474 and 18476.....
220J	3729	Clamp Leveling Thumb Screw Stop Bracket Screw for 17953.....
220J	3729	Clamp Stretching Ring Spring Adjusting Screw for 17953.....
229J	5017	Button Clamp Spring Screw for 18467, 39249, 63928 and 63929.....
229D	5017	Oscillating Shaft Crank Slide Block Cap Screw for 15171.....
229D	5037	Thread Wiper Body Wire Screw for 69-25 Machine.....
233D	3722	Face Plate Thread Guard Screw for 17725 and 55274.....
233D	3722	Thread Take-up Spring Reglator Plate Adjusting Screw for 17725 and 55274..
236J	3705	Button Clamp Spring Screw for 17898 and 17904.....
236K	5038	Button Clamp Shank Screw for 55213....
237F	3724	Needle Set Screw for 17831 and 55241...
237F	5017	Oscillating Shaft Crank Set Screw for 18387.....

NUMERICAL LIST OF PARTS

NO.	PLATE	NAME
237F	7009	Protector Rod Collar Set Screw for 15261
237F	7009	" Spring Collar Set Screw for 15261
335D	3759	Needle Bar Thread Nipper Driving Lever Extension Screw for 39350
337D	3718	Needle Bar Thread Nipper Lever Spring Screw, obsolete
337D	3718	Thread Wiper Body Wire Screw for all machines except 69-25
357C	5038	Stop Cam Interlocking Rod Case Spring Adjusting Screw for 55247
375C	3724	Crank Connecting Rod Hinge Screw
377C	3718	Needle Bar Connecting Link Hinge Screw
398E	3702	Shuttle Main Spring Screw for 39295
401D	5038	Cylinder Lower Cover Screw for 69-25 Machine
418E	3722	Bobbin Winder Tension Screw Stud for 5989
419E	5042	Bobbin Winder Tension Screw Stud for 60770
426C	7009	Protector Bracket Adjusting Screw for 39491
430C	3759	Stop Cam Interlocking Rod Case Spring Adjusting Screw for 39344
435C	3724	Arm Shaft Bushing (back) Adjusting Screw, obsolete
443C	5042	Treadle Shaft Set Screw for 17876 and 17943
446C	3724	Thread Take-up Cam Set Screw for 18392 and 39204
448C	3722	Tension Screw Stud Set Screw for 17725 and 55274
448C	7009	Protector Rod Sleeve Set Screw for 39491
448C	5038	Table Belt Guide Pulley Shaft Set Screw for 14229
453C	5007	Feed Cam Driving Worm Wheel Set Screw for 17797, 17997 and 39212
453C	5007	Presser Bar Guide Bracket Set Screw for 17842
453C	5005	Cylinder Base Plate Hinge Connection Hinge Pin Set Screw for 18419 and 55259
453C	5007	Feed Cam Driving Worm Set Screw for 17796, obsolete
453C	5038	Thread Unwinder Thread Guard Rod Set Screw for 27940
454C	7009	Protector Crank Bracket Set Screw for 39493

NUMERICAL LIST OF PARTS

NO.	PLATE	NAME
456C	5038	Thread Unwinder Thread Guard Rod Coupling Set Screw for 41639
457C	5038	Treadle Chain Guide Pulley Pin Set Screw for 55261 and 55266
457C	3702	Shuttle Driver Set Screw for 17850 and 39487
460C	5021	Guide Set Screw for 39205
462C	5017	Shuttle Driver Set Screw for 2441
466H	3702	" Tension Regulating Screw for 44001
578K	3729	Clamp Stretching Ring Spring Screw for 17953
591F	5017	Shuttle Tension Regulating Screw for 15142 and 15277
592E	5017	Shuttle Bobbin Case Latch Stop Screw for 15142 and 15277
600C	3722	Tension Screw Stud for 17725 and 55274
624C	5038	Bobbin Winder Thread Eyelet Rod Set Screw for 41601
641C	5034	Button Clamp Head Set Screw for 18500
641C	5034	" " Shaft Set Screw for 55210
641C	5021	Thread Wiper Body Support Set Screw for all machines except 69-25
662D	5036	Needle Bar Thread Nipper Lever Spring Screw for 69-25 Machine
662D	5018	Shuttle Race Cap Screw for 18414 and 18430
670E	5021	Knife Cam Lever Bracket Screw
690D	3748	Feed Across Regulator Hinge Stud Clamping Screw for 18369 and 18469
691F	5015	Throat Plate Screw
748E	5042	Brace Screw for 25285
757D	5036	Feed Plate Bushing Screw for 55218
780E	5042	Treadle Support Bolt with 1600E, for 25285
810D	3759	Feed Regulator Post Guide Cap Screw for 18486
858C	5038	Table Belt Guide Pulley Shaft Oil Hole Plug Screw for 39708
880E	3724	Arm Screw for all machines except 69-25
898D	3721	Stop Cam Interlocking Rod Case Socket Joint Cap Screw for 18425, 18442, 18458, 55247, 55304 and 55305
910C	5021	Button Clamp Lifting Lever Hinge Pin Set Screw for 55205 and 55276
914F	5036	Feed Plate Carrier Bar Block Screw for 55236

NO.	PLATE	NAME
914f	5036	Thread Wiper Body Support Bracket Screw for 69-25 Machine
934d	5007	Feed Plate Carrier Bar Plate Screw for 18365, 18438, 18448, 18451 and 18486..
957k	3738	Clamp Spreader Lever Cap Screw for 18452.....
1019c	5009	Hand Stop Lever Rod Collar Set Screw for 21678.....
1035c	5017	Oscillating Shaft Crank Slide Block Screw Stud for 15171.....
1064d	5038	Treadle Chain Guide Pulley Screw for 55265.....
1099f	7009	Protector Rod Screw Stud for 63753.....
1120c	7009	" Crank Hinge Stud Set Screw for 39493.....
1143c	5021	Button Clamp Lifting Lever Spring Set Screw for 55206.....
1149c	5038	Thread Unwinder Spool Rest Set Screw for 60455.....
1174d	3724	Belt Shifter Screw for 17705 and 17940, obsolete.....
1174d	3724	Knife Cam Lever Slide Screw for 39237, obsolete.....
1175j	3704	Arch Clamp Foot Spring Connection Hinge Screw for 18436, 18449 and 18462
1175j	3704	Arch Clamp Foot Spring Screw (upper) for 18453.....
1175j	3704	Button Clamp Hinge Screw for 17898, 17904, 18467, 39249, 55213, 63928 and 63929.....
1175j	3704	Clamp Hinge Screw for 17912.....
1175d	5037	Thread Wiper Body Hinge Screw for 69-25 Machine.....
1176j	3704	Button Clamp Arm Hinge Plate Screw for 69-5, 69-6, 69-15, 69-17 and 69-18 Machines.....
1177d	3710	Arch Clamp Frame Screw for 18449.....
1177d	5038	Bobbin Winder Bracket Screw for 41605
1177d	3710	Button Clamp Pressure Spring Bracket Screw for 69-5, 69-6, 69-15, 69-17 and 69-18 Machines.....
1177d	3710	Clamp Pressure Spring Bracket Screw for 18452.....
1177d	3710	Cylinder Block Screw for 69-25 Machine
1177d	3710	Feed Cam Shaft Bracket Screw (back) for all machines except 69-25.....

NO.	PLATE	NAME
1177d	3710	Feed Cam Shaft Flanged Bushing Screw for 18495.....
1177e	3710	Feed Regulator Bracket Screw for all machines except 69-25.....
1177d	3710	Knife Cam Lever Hinge Screw Bushing Clamping Screw for 18470.....
1177e	3710	Motor Treadle Bracket (left) Screw for 46618.....
1177e	3710	Motor Treadle Bracket (right) Screw for 46618.....
1177e	3710	Starting Treadle Bracket (left) Screw for 46618.....
1177e	3710	Starting Treadle Bracket (right) Screw for 46618.....
1178j	3710	Button Clamp Pressure Spring Screw for 69-5, 69-6, 69-15, 69-17 and 69-18 Machines.....
1178j	3761	Clamp Arm Screw for 39336.....
1178j	3710	" Pressure Spring Screw for 18452..
1180j	3705	Button Clamp Spreader Lever Locking Thumb Screw for 17898, 17904, 18467, 39249, 55213, 63928 and 63929.....
1181r	3705	Button Clamp Spreader Spring Screw for 17898, 17904, 63928 and 63929.....
1182j	3705	Button Clamp Spreader Screw for 17898, 17904, 18467, 39249, 55213, 63928 and 63929.....
1182j	3705	Clamp Spreader Spring Screw for 17912
1182e	3705	Trip Lever Spring Screw for 18425, 18442, 18458, 55247, 55304 and 55305.....
1183j	3705	Button Clamp Stop Screw for 17898, 17904, 18467, 39249, 55213, 63928 and 63929.....
1184c	5008	Feed Across Knuckle Joint Hinge Screw for all machines except 69-25.....
1186c	3781	Bobbin Winder Base Screw for 41605, 41714 and 41716.....
1186c	5021	Bobbin Winder Tension Bracket Screw for 41605.....
1186d	5021	Stop Cam Interlocking Rod Case Spring Bracket Screw for 18493 and 18494....
1187e	5008	Feed Across Regulator Adjusting Stud for all machines except 69-25.....
1190c	5009	Feed Regulator Stop Screw.....
1191d	5009	" " Thumb Screw.....

NUMERICAL LIST OF PARTS

NO.	PLATE	NAME
1192c	372A	Feed Cam Set Screw for 17766, 18395 to 18399, 18401 to 18406, 55225, 55308 and 55309.....
1193d	372A	Feed Cam Shaft Bracket Screw (front) for all machines except 69-25.....
1194d	5007	Feed Plate Carrier Bar Pivot Block Screw
1195E	5013	" " Screw Stud for 18365, 18438, 18448, 18486 and 55236.....
1196c	372I	Needle Bar Thread Nipper Driving Lever Hinge Screw.....
1196c	372I	Trip Lever Hinge Screw for 18425, 18442, 18458, 55247, 55304 and 55305.....
1197d	372A	Knife Cam Lever Hinge Screw, obsolete
1198c	5015	" " Screw for 55296 and 55317.....
1200d	3718	Needle Bar Thread Nipper Lever Hinge Screw.....
1200d	5036	Tension Releasing Lever Hinge Screw for 69-25 Machine.....
1201c	502I	Presser Bar Lifting Lever Hinge Screw for all machines except 69-25.....
1201c	502I	Knife Bar Driving Lever Hinge Screw, obsolete.....
1202d	372A	Pulley (loose) Cap Screw for 17955.....
1203c	372A	Starting Lever Hinge Screw, obsolete...
1204E	372I	Stop Cam Interlocking Rod Case Hinge Screw for 18425, 18442, 18458, 55247, 55304 and 55305.....
1206c	372I	Stop Cam Screw for 17955.....
1207d	3710	Thread Wiper Body Hinge Screw for all machines except 69-25.....
1208j	5020	Button Clamp Spring Screw for 17931, 17936 and 55257.....
1208j	5020	Clamp Hook Stop Screw for 17912.....
1208j	5020	" " Spring Screw for 17912.....
1208d	5020	Throat Plate Needle Hole Bushing Screw for 18381, 18382, 18454 and 55314.....
1219j	3709	Clamp Spreader Stud for 17912.....
1220E	3706	Button Clamp Screw Stud for 17926 and 17933.....
1221c	5007	Feed Plate Carrier Bar Block Screw for 18365, 18438, 18448, 18451 and 18486
1229F	502I	Arch Clamp Foot Spring Adjusting Screw for 18483.....
1253c	5038	Oscillating Shaft Crank Set Screw for 55246.....

NUMERICAL LIST OF PARTS

NO.	PLATE	NAME
1254c	502I	Stop Cam Interlocking Rod Case Stop Stud Screw Bushing for 18425, 18442, 18458, 55247, 55304 and 55305.....
1255d	502I	Belt Shifter Clamp Screw for 18425, 18442, 18458 and 55285.....
1255d	502I	Knife Cam Lever Slide Screw for 39460
1255d	502I	Belt Shifter Screw for 39201, obsolete...
1255d	502I	Stop Cam Interlocking Rod Case Extension Screw for 18380, obsolete.....
1262c	502I	Starting Lever Hinge Screw for 18425, 18442, 18458, 55247, 55304 and 55305
1263j	3729	Clamp Leveling Thumb Screw for 17953
1264j	3729	" " Stretching Ring Hinge Screw for 17953.....
1267d	3740	Clamp Arm Bracket Screw for 18446 and 18455, obsolete.....
1289d	5018	Shuttle Race Ring Spring Screw for 18414, 18430 and 55272.....
1299c	5007	Feed Cam Driving Worm Position Screw, obsolete.....
1300d	376I	Clamp Arm Bracket Hinge Block Screw for 39336.....
1300d	3748	Cylinder Block Screw for all machines except 69-25.....
1300d	3748	Stop Cam Interlocking Rod Case Extension Screw for 18418 for 18425, obsolete
1318d	3748	Stop Cam Interlocking Rod Stop Screw for 18425, 18442, 18458 and 55285.....
1329d	5009	Needle Bar Thread Nipper Lever Spring Screw for all machines except 69-25
1343E	502I	Stop Cam Interlocking Rod Case Bracket Screw.....
1382F	5016	Knife Bar Driving Lever Hinge Screw...
1420E	5016	" " " " Lock Stud Stop Screw for 39297.....
1441c	502I	Feed Cam Driving Worm Set Screw for 18415, 39211 and 39231.....
1442c	502I	Feed Cam Driving Worm Position Screw for 18415, 39211 and 39231.....
1484F	5037	Thread Wiper Body Arm Screw for 69-25 Machine.....
1508E	502I	Stop Cam Interlocking Rod Case Stop Stud Screw Bushing Lock Nut for 18425, 18442, 18458, 55247, 55304 and 55305
1513j	372A	Oscillating Rock Shaft Hinge Pin Nut for 55278 and 56812.....
1518E	3718	Crank Connecting Rod Hinge Screw Nut

NUMERICAL LIST OF PARTS

NO.	PLATE	NAME
1518E	3718	Needle Bar Connecting Link Hinge Screw Nut.....
1519E	5017	Oscillating Shaft Crank Slide Block Screw Stud Nut for 18387 and 55246.....
1520E	3724	Arm Shaft Bushing (back) Adjusting Screw Nut.....
1520E	3759	Stop Cam Interlocking Rod Case Spring Adjusting Screw Nut for 39344.....
1547J	5021	Arch Clamp Foot Spring Adjusting Screw Lock Nut for 18483.....
1560C	3722	Tension Regulating Thumb Nut for 17725 and 55274.....
1562J	3722	Bobbin Winder Tension Regulating Thumb Nut for 5989 and 60770.....
1565D	5009	Hand Stop Lever Rod Head for 69-8 Machine.....
1600E	5042	Treadle Support Bolt Nut for 780E.....
1620J	5042	Bobbin Winder Frame Hinge Screw Nut for 41604 and 41713.....
1650C	5038	Stop Cam Interlocking Rod Case Spring Adjusting Screw Nut for 55247.....
1651E	5021	Needle Bar Thread Nipper Rod Adjusting Stud Lock Nut.....
1652D	5021	Feed Across Regulator Adjusting Stud Thumb Nut, obsolete.....
1653C	3724	Feed Cam Shaft Nut.....
1654C	5013	Clamp Arm Bracket Hinge Screw Nut for 39336.....
1654C	5013	Feed Plate Nut.....
1654C	5013	Knife Cam Lever Roller and Screw Stud Nut for 1980.....
1655C	5021	Feed Regulator Roller and Screw Stud Nut for 1953.....
1656J	3706	Button Clamp Thumb Nut for 17932, 17937 and 55257.....
1657J	3709	Clamp Spreader Stud Thumb Nut for 17912.....
1662C	5021	Starting Lever Hinge Screw Nut for 18425, 18442, 18458, 55247, 55304 and 55305.....
1676C	5008	Feed Across Regulator Adjusting Stud Nut for all machines except 69-25.....
1681C	5016	Knife Bar Driving Lever Hinge Screw Nut
1698C	5021	" Holder Pinion Stud Bracket Screw Nut for 55301, 55306, 55310, 55315 and 55318.....
1819	5038	Thread Take-up Lever Roller and Stud for 3072.....

NUMERICAL LIST OF PARTS

NO.	PLATE	NAME
1822	5021	Thread Take-up Lever Roller and Stud for 18393.....
1952	5008	Feed Across Regulator Roller and Stud for 18356.....
1953	5021	Feed Regulator Roller and Screw Stud with 1655c and 14017, for 17742, 18487 and 39312.....
1964	5015	Knife Cam Lever Roller and Stud for 39236, obsolete.....
1980	3759	Knife Cam Lever Roller and Screw Stud with 1654c, for 39330.....
1993	5038	Button Clamp Shank Roller and Stud for 55211 and 55255.....
2002	3722	Arm Dowel Pin, obsolete.....
2022	3722	Pulley (tight) Pin.....
2049	5017	Feed Plate Carrier Bar Block Steady Pin for 55236.....
2049	5017	Oscillating Shaft Crank Pin for all machines except 69-25.....
2049	5017	Shuttle Driver Pin.....
2058	5002	Presser Bar for all machines except 69-25
2073	3702	Shuttle Bobbin for 39296.....
*2075	—	" Cover for 44001.....
2076	3702	" Hinge Pin for 39296.....
2078	3702	" Delivery Eye Thread Guard for 44001.....
2080	3702	Shuttle Delivery Eye Thread Guard Rivet for 44001.....
2082	3702	Shuttle Main Spring for 39295.....
2084	3702	" " " Steady Pin for 39295
2086	3702	" Tension Spring for 44001.....
2090	3702	" " " Plate for 44001.....
2102	3722	Tension Disc for 17725 and 55274.....
2103	3722	" Spring for 17725 and 55274.....
2105	3722	" Thread Guard for 55274 and 63736
2107	3722	Face Plate Thread Guard for 17725 and 55274.....
2117	3722	Feed Cam Driving Worm Pin, obsolete...
2124	3722	Thread Take-up Spring for 17725 and 55274.....
2127	3722	Thread Take-up Spring Regulator Plate for 17725 and 55274.....
2211	3702	Shuttle Bobbin Retaining Spring for 39295
2212	3702	" " " " Rivet for 39295.....
2269	3722	Pulley (loose) Bushing Position Pin for 17849 and 17942.....

NUMERICAL LIST OF PARTS

NO.	PLATE	NAME
2441	5017	Shuttle Driver 2542 with two 462c, for all machines except 69-16 and 69-19
2455	3781	Bobbin Winder Tension Disc for 5989 and 60770
2523	5017	Shuttle Bobbin Case Position Finger Rivet for 15142 and 15277
2523	5018	Shuttle Race Cap Steady Pin for 18414 and 18430
*2542	—	Shuttle Driver for 2441
2973	5017	" Bobbin Case Latch Lever for 15141
2974	5017	" " " " " Fulcrum Pin for 15141
2975	5017	Shuttle Bobbin Case Latch Spring for 15142 and 15277
2996	5017	Shuttle Bobbin for 21561
3012	3722	Feed Cam Driving Worm Wheel Pin
3012	3722	Stop Cam Pin
3012	3722	Thread Take-up Cam Pin
3052	3711	Oscillating Rock Shaft Hinge Pin for 56812
3072	5028	Thread Take-up Lever with 1819, for 69-16 and 69-19 Machines
4292	5002	Crank Connecting Rod with 4349 and two 158E
*4349	—	Crank Connecting Rod Cap for 4292
4389	5042	Arm Dowel Pin for all machines except 69-25
4448	3722	Arm Oil Tube, for intermediate bearing, for all machines except 69-25
*4449	—	Arm Shaft Bushing (front) for 18351, 18439, 18457 and 18495
4604	5008	Cylinder End Cover Bracket Rivet for 18427
4784	5009	Oscillating Rock Shaft Oil Pad for 6022
4879	5023	Motor Treadle Chain Connecting Link for 46616
4879	5023	Starting Treadle Chain Connecting Link for 46616
4879	5023	Treadle Chain Connecting Link for 4885
4881	7219	Motor Treadle for 46616
4881	7219	Starting Treadle for 46616
4881	5040	Treadle for 4885
4882	5023	Motor Treadle Shaft for 46616
4882	5023	Starting Treadle Shaft for 46616
4882	5023	Treadle Shaft for 4885
4883	5023	Motor Treadle Spring for 46616
4883	5023	Starting Treadle Spring for 46616
4883	5023	Treadle Spring for 4885

NUMERICAL LIST OF PARTS

NO.	PLATE	NAME
4884	5040	Treadle Stand for 4885
4885	5040	Treadle complete for 69-25 Machine, Nos. 4879, 4881 to 4884 and two wood screws 1 in. No. 16
5944	5015	Knife Cam Lever Slide Steady Pin, obsolete
5989	—	Bobbin Winder Tension complete for 41602, Nos. 418E, 1562J, 10141 and two 2455
6022	5001	Oscillating Rock Shaft (steel) with 4784, for 16806 and 55278
6023	5028	Oscillating Shaft for 69-16 and 69-19 Machines
6489	5001	Oscillating Rock Shaft Hinge Pin for 55278
7071	5008	Knife Bar Connection Screw Washer
7071	5008	Button Clamp Spreader Spring Screw Washer for 18467 and 39249, obsolete
7298	5015	Knife Holder Pinion Dowel Pin for 17825
7401	3738	Clamp Arm (lower) Bracket Steady Pin for 18452
7569	5005	Cylinder End Cover Hinge Pin for 18378, obsolete
8414	5001	Presser Bar Spring for all machines except 69-25
8422	3781	Bobbin Winder Tension Thread Guide for 60770
8575	5036	Feed Regulator Bracket Dowel Pin for 69-25 Machine
8589	3722	Feed Regulator Bracket Dowel Pin for all machines except 69-25
8589	3722	Knife Cam Lever Bracket Dowel Pin
9311	3747	Button Clamp Spring Steady Pin for 18464, 18465, 39238 and 39239
9330	3740	Clamp Arm Pin for 18446 and 18490
9780	3781	Bobbin Winder Tension Bracket Position Stud for 60770
10141	3722	Bobbin Winder Tension Spring for 5989
10145	5016	" " " Thread Guide for 41602
10875	5023	Wrench for 1518, 1520 and 1650 (Attachments and Accessories)
11742	3710	Table Belt Guide Pulley Washer for 17897, obsolete
11831	5023	Screw Driver, large (Attachments and Accessories)
12424	5017	Oscillating Shaft Crank Slide Block Cap Screw Washer for 15171

84 NUMERICAL LIST OF PARTS

NO.	PLATE	NAME
13351	—	Treadle Chain, 46 in. to 55 in. long, with 56864 and 56865, for starting lever, for 69-25 Machine.
14008	3737	Clamp Arm (upper) Bracket Hinge Pin for 18452.
14017	5015	Feed Regulator Roller and Screw Stud Nut Washer for 1953.
14079	3731	Arch Clamp Frame Dowel Pin for 18436, 18449, 18453, 18462 and 18483.
14229	5039	Table Belt Guide Bracket with 448c, for 39709 and 39716.
15027	5017	Shuttle Bobbin Case Position Finger for 15142 and 15277.
15072	5009	Bobbin Winder Bobbin Position Pin for 27538.
15098	5027	Shuttle Tension Spring for 15142, obsolete
15140	5017	" Bobbin Case Latch for 15141.
15141	—	" " " " Hinge for 15142 and 15277, Nos. 2973, 2974 and 15140
15142	5027	Shuttle Bobbin Case complete for 21561, Nos. 591r, 592e, 2523, 2975, 15027, 15098 and 15141, obsolete, use 15277.
15170	5017	Oscillating Shaft Crank Slide Block for 15171.
15171	5017	Oscillating Shaft Crank Slide Block complete for 18387 and 55246, Nos. 229d, 1035c, 12424 and 15170.
15261	7009	Protector Rod Collar with 237r, for 63753
15261	7009	" " Spring Collar with 237r, for 63753.
15277	5017	Shuttle Bobbin Case complete for 21561, Nos. 591r, 592e, 2523, 2975, 15027, 15141 and 15278.
15278	5017	Shuttle Tension Spring for 15277.
16532	3722	Stop Cam Interlocking Rod Case Bracket Dowel Pin.
16806	—	Oscillating Rock Shaft complete for 69-19 Machine, Nos. 6022 and 56812.
17702	5000	Arm Shaft for all machines except 69-25
17703	5001	" " Bushing (back) for all machines except 69-25.
17705	5019	Belt Shifter for 17847 and 17849, obsolete
17706	3704	Button Clamp (left) with 17723, for 17898 and 55213.
17707	3704	Button Clamp (right) with 17723, for 17898 and 55213.

NUMERICAL LIST OF PARTS

85

NO.	PLATE	NAME
17708	3710	Button Clamp Lifter with 17866, for 69-5, 69-6, 69-15, 69-17 and 69-18 Machines
17710	3704	Button Clamp Arm Hinge Plate for 69-5, 69-6, 69-15, 69-17 and 69-18 Machines
17711	3704	Button Clamp Arm Hook for 17901.
17712	3710	" " Pressure Spring for 17898, 17904, 17932 and 17937.
17712	3710	Clamp Pressure Spring for 17912 and 17953.
17713	3710	Button Clamp Pressure Spring Bracket for 69-5, 69-6, 69-15, 69-17 and 69-18 Machines.
17713	3710	Clamp Pressure Spring Bracket for 18452
17714	3704	Button Clamp Pressure Spring Guide Block for 17901, 17927, 39240 and 63927.
17714	3704	Clamp Pressure Spring Guide Block for 17908 and 17947.
17716	3705	Button Clamp Spreader for 17898, 17904 and 55213.
17717	3705	Button Clamp Spreader Lever for 17898, 17904, 18467, 39249, 55213, 63928 and 63929.
17718	3705	Clamp Spreader Stud Thumb Nut Washer for 17912.
17718	3705	Button Clamp Spreader Lever Locking Thumb Screw Washer for 17898, 17904, 18467, 39249, 55213, 63928 and 63929
17719	3705	Button Clamp Spreader Spring for 17898, 17904, 63928 and 63929.
17720	3705	Button Clamp Spring Steady Pin for 18499
17720	3705	" " Spreader Steady Pin for 17722, 17903, 18466 and 39248.
17721	3705	Button Clamp Spring, for flat buttons, for 17898.
17722	3705	Button Clamp Stop with two 17720, for 17898 and 55213.
17723	3704	Button Clamp Stud for 17706, 17707, 17899, 17900, 18464, 18465, 39238 and 39239.
17724	5001	Face Plate for 63736.
17725	—	Face Plate complete for all machines except 69-25, Nos. 448c, 600c, 1560c, 2103, 2107, 2124, 2127, 63736 and two each 233d and 2102.
*17732	—	Feed Regulator Bracket Cap for 18369.

NO.	PLATE	NAME
17738	5008	Feed Across Regulator Adjusting Stud Nut Washer for all machines except 69-25
17739	5008	Feed Across Regulator Adjusting Stud Sleeve for all machines except 69-25
17741	5008	Belt Cover Bracket Stud for 39290
17742	5006	Feed Regulator with 1953, for 69-5 to 69-13, 69-17 to 69-19 and 69-25 Machines
17743	5009	Feed Regulator Post for 18365, 18438, 18448, 18451 and 55236
17744	5009	Feed Regulator Hinge Stud
17745	5009	" " Swivel for all machines except 69-15
17748	3722	Thread Eyelet (top of arm) obsolete
17766	—	Feed Cam with two each 1192c, 17874 and four 190d, for 69-19 Machine
17796	5005	Feed Cam Driving Worm with 453c, for 69-5, 69-6 and 69-8 to 69-11 Machines, obsolete
17797	5004	Feed Cam Driving Worm Wheel with 453c, for 69-5, 69-6, 69-8 to 69-11, 69-13, 69-14, 69-16 and 69-25 Machines
17798	5024	Feed Cam Shaft, obsolete
17799	5024	" " " Bracket, obsolete
17800	5013	Feed Plate (thin) for flat buttons, for 69-5, 69-6, 69-17 and 69-18 Machines
17805	5007	Feed Plate Carrier Bar Pivot Block
17806	5013	" " Position Stud for 18365, 18438, 18448, 18486 and 55236
17806	5013	Feed Plate Rivet for 18452
17807	5042	Knife (needle thread) for 55317
17808	5015	" (shuttle thread) for 55296 and 55317
17817	5025	" Bar Driving Lever Lock Stud for 17918, obsolete
17822	5015	Knife Bar Rack Rivet for 18370, 18426 and 55240
17825	5015	Knife Holder with 17826, 17830 and two 7298, for 55296 and 55317
17826	5015	Knife Holder Pinion for 17825
17827	5015	" " " Stud for 17828
17828	5015	" " " Bracket with 17827, for 55301, 55306, 55310, 55315 and 55318
17829	5015	Knife Thread Holder for 55296 and 55317
17830	5015	" " " Position Pin for 17825
17831	5002	Needle Bar with 237F, for all machines except 69-25

NO.	PLATE	NAME
17832	5001	Needle Bar Thread Nipper Driving Lever, obsolete
17833	5001	Needle Bar Thread Nipper Driving Lever Spring, obsolete
17834	3718	Needle Bar Thread Nipper Lever with 17835
17835	3718	Needle Bar Thread Nipper Lever Bushing for 17834
17835	5036	Tension Releasing Lever Bushing for 55249
17836	3718	Needle Bar Thread Nipper Lever Spring for 337, obsolete
17837	5019	Needle Bar Thread Nipper Rod for all machines except 69-25
17838	3718	Needle Bar Thread Nipper Rod Adjusting Stud
17839	3718	Needle Bar Thread Nipper Rod Arm with 196F
17840	5001	Needle Bar Thread Nipper Rod Support
Nos. 17841 TO 17846 FOR ALL MACHINES EXCEPT 69-25		
17841	3718	Presser Bar Collar with two 196F
17842	3718	" " Guide Bracket with 453c
17843	5006	" " Lifting Lever
17844	5006	" " " Bracket for 18351, 18439 and 18457
17845	5019	Presser Bar Lifting Lever Rod
17846	—	" " " " Chain
17847	5024	Pulley (loose) 2½ in. diam., obsolete
17848	5003	" " Bushing for 17955
17849	5024	" (tight) 2½ in. diam., with 2269, obsolete
17850	—	Shuttle Driver with two 457c, for 69-16 Machine, obsolete, use 39487
17853	5003	Starting Lever for 18425, 18442, 18458, 55247, 55304 and 55305
17854	3721	Stop Cam for 17955
17855	3721	" " Interlocking Rod for 18425, 18442, 18458 and 55285
17857	5024	Stop Cam Interlocking Rod Case Bracket for 18425, obsolete
17859	5003	Stop Cam Interlocking Rod Case Socket Joint for 18425, 18442, 18458, 55247, 55304 and 55305
17860	3721	Stop Cam Interlocking Rod Case Spring for 18425, 18442 and 18458, obsolete

NUMERICAL LIST OF PARTS

NO.	PLATE	NAME
17861	3721	Stop Cam Interlocking Rod Case Stop Stud for 18425, 18442, 18458, 55247, 55304 and 55305.....
17862	3721	Stop Cam Interlocking Rod Case Stop Stud Spring for 18425, 18442, 18458, 55247, 55304 and 55305.....
17863	3721	Stop Cam Interlocking Rod Spring for 18425, 18442, 18458 and 55285.....
17864	3721	Stop Cam Interlocking Rod Stop for 18425, 18442, 18458 and 55285.....
17865	3710	Thread Wiper Body for all machines except 69-25.....
17866	3710	Thread Wiper Body Arm Pin for 55251..
17866	3710	" " " Hook for 17708, 17958 and 39206.....
17867	3710	Thread Wiper Body Support for all machines except 69-25.....
17868	3710	Thread Wiper Body Wire for all machines except 69-25.....
17869	3710	Thread Wiper Body Wire Screw Washer
17871	5020	Throat Plate Needle Hole Bushing for 18381.....
17872	3721	Trip Lever for 18425, 18442, 18458, 55247, 55304 and 55305.....
17873	3721	Trip Lever Spring for 18425, 18442, 18458, 55247, 55304 and 55305.....
17874	5009	Tripping Point for 17766, 18395 to 18399, 18401 to 18406, 55225, 55308 and 55309
17876	5022	Treadle with 443c, for 17884.....
17877	5000	" Pitman Rod (lower) for 17890..
17878	5000	" " " (upper) for 17880..
17879	5000	" " " Clamp with two 161n for 17880.....
17880	5000	Treadle Pitman complete for 17885 and 17891, Nos. 17877 to 17879.....
Nos. 17881 TO 17883 FOR 17884, 17890 AND 17945		
17881	5005	Treadle Shaft.....
17882	5005	" Spring.....
17883	5022	" Stand.....
17884	—	Treadle complete for 17885, Nos. 17876, 17881 to 17883 and two wood screws 1 in. No. 10.....
17885	—	Treadle and Pitman complete for all machines except 69-25, Nos. 17880 and 17884.....

NUMERICAL LIST OF PARTS

NO.	PLATE	NAME
17886	5019	Starting Lever Pitman for all machines except 69-25.....
17887	5022	Starting Lever Treadle for 17890, obsolete
17888	5022	" " " Extension with 17889, for 17890, obsolete.....
17889	3718	Starting Lever Treadle Extension Hook for 17888, obsolete.....
17890	—	Starting Lever Treadle complete for 17891, Nos. 17881 to 17883, 17887, 17888 and two each 160e and wood screws 1 in. No. 10, obsolete, use 17945.....
17891	—	Starting Lever Treadle and Pitman complete, Nos. 17880 and 17945, obsolete..
17892	5022	Table Belt Guide Bracket with two 153e, for 17897 and 39221.....
17893	5022	Table Belt Guide Pulley for 17897 and 39221.....
17894	5022	Table Belt Guide Pulley Shaft (long) with two 17896, for 17897, obsolete.....
17895	5022	Table Belt Guide Pulley Shaft (short) with two 17896, for 17897, obsolete.....
17896	5005	Table Belt Guide Pulley Shaft Plug for 17894, 17895, 39219 and 39220.....
17897	—	Table Belt Guide complete, Nos. 17892, 17894, 17895, two each 11742, 17893, 25350 and three wood screws 1¼ in. No. 12, obsolete, use 39221.....
17898	3703	Button Clamp (universal) complete, for 14 to 36 line buttons, for 69-5, 69-6, 69-17 and 69-18 Machines, Nos. 236j, 1180r, 1181r, 1182r, 1183r, 17706, 17707, 17716 to 17719, 17721 or 17938, 17722, 17901, 50237k and two 1175r.....
17899	3708	Button Clamp (left) with 17723, for 17904
17900	3708	" " (right) with 17723, for 17904
17901	3704	" " Arm with 17711, 17714 and 23227, for 17898 and 17904.....
17902	3708	Button Clamp Spring, for flat buttons, for 17904.....
17903	3708	Button Clamp Stop with two 17720, for 17904.....
17904	—	Button Clamp (universal) complete, for 26 to 46 line buttons, for 69-5, 69-6, 69-17 and 69-18 Machines, Nos. 236j, 1180r, 1181r, 1182r, 1183r, 17716 to 17719, 17899 to 17901, 17902 or 17939, 17903, 50237k and two 1175r.....

NO.	PLATE	NAME
17905	5023	Wrench for 1178, 1654 and 1676 (Attachments and Accessories).....
Nos. 17906 to 17911 FOR 17912		
17906	3709	Clamp (left) with 23219.....
17907	3709	“ (right).....
17908	3709	“ Arm with 17714 and 63788.....
17909	3709	“ Spreader Spring.....
17910	3709	“ Spring.....
17911	3709	“ Hook Stop.....
17912	—	Clamp complete, for hooks and eyes, for 69-5 and 69-6 Machines, Nos. 1182j, 1219r, 1657j, 17718, 17906 to 17911 and two each 1175j and 1208j.....
17915	5016	Knife Bar Connection Slide Block for 17917.....
17916	5016	Knife Bar Connection Slide Block Stud for 17917.....
17917	—	Knife Bar Connection Slide Block 17915 with 17916, for 18372.....
17918	5025	Knife Bar Driving Lever with 190b, 17817, 17919 and 17920, obsolete, use 39297.....
17919	5016	Knife Bar Driving Lever Lock Stud Spring for 17918 and 39297.....
17920	5025	Knife Bar Driving Lever Lock Stud Stop Pin for 17918, obsolete.....
17923	5013	Feed Plate (thick) for round bottom buttons, for 69-5, 69-6, 69-17 and 69-18 Machines.....
17924	5020	Throat Plate Needle Hole Bushing for 18382.....
17926	3706	Button Clamp with 1220E and 17928, for 17931 and 55257.....
17927	3706	Button Clamp Arm with 17714 and 63788, for 17932 and 17937.....
17928	3706	Button Clamp Position Stud for 17926 and 17933.....
17929	3706	Button Clamp Spring, for flat buttons, for 17931.....
17930	3706	Button Clamp Spring, for stud back buttons, for 17931.....
17931	—	Button Clamp (end opening) complete for 17932, Nos. 17926, 17929 or 17930 and two 1208j.....
17932	—	Button Clamp (end opening) with Arm complete for 69-5 and 69-6 Machines, Nos. 1656j, 17927 and 17931.....

NO.	PLATE	NAME
17933	3707	Button Clamp with 1220E and 17928, for 17936.....
17934	3707	Button Clamp Spring, for flat buttons, for 17936.....
17935	3707	Button Clamp Spring, for stud back buttons, for 17936.....
17936	—	Button Clamp (side opening) complete for 17937, Nos. 17933, 17934 or 17935 and two 1208r.....
17937	—	Button Clamp (side opening) with Arm complete for 69-5 and 69-6 Machines, Nos. 1656j, 17927 and 17936.....
17938	3705	Button Clamp Spring, for stud back buttons, for 17898.....
17939	3708	Button Clamp Spring, for stud back buttons, for 17904.....
17940	5019	Belt Shifter, obsolete.....
17941	5003	Pulley (loose) 2 1/4 in. diam., for 17955.....
17942	5003	“ (tight) 2 1/8 in. diam., with 2269, for 17955.....
17943	3741	Starting Lever Treadle with 196r and 443c, for 17945, obsolete.....
17944	3741	Starting Lever Treadle Extension for 17945, obsolete.....
17945	—	Starting Lever Treadle complete for 17891, Nos. 17881 to 17883, 17943, 17944 and two wood screws 1 in. No. 10, obsolete.....
17946	3729	Clamp with 17948, for 17953.....
17947	3729	“ Arm with 17714 and 63788, for 17953.....
17948	3729	Clamp Hinge Stud for 17946.....
Nos. 17949 to 17952 FOR 17953		
17949	3729	Clamp Hinge Stud Pin.....
17950	3729	“ Leveling Thumb Screw Stop Bracket.....
17951	3729	Clamp Stretching Ring.....
17952	3729	“ “ Spring.....
17953	—	Clamp complete, for tying French knots, for 69-5 Machine, Nos. 578K, 1263j, 17946, 17947, 17949 to 17952, two 1264j and three 220j.....
17954	5014	Feed Plate for 17953.....
17955	—	Pulleys complete, Nos. 1202D, 1206C, 17848, 17854, 17941 and 17942.....
17957	3731	Arch Clamp Foot with 17959, for 18453..

NO.	PLATE	NAME
17958	3733	Arch Clamp Foot Lifter with 17866, for 69-8, 69-9, 69-14 and 69-16 Machines...
17958	3733	Clamp Arm Lifter with 17866, for 69-7, 69-12, 69-13 and 69-19 Machines.....
17958	3733	Clamp Arm (upper) Lifter with 17866, for 69-10 Machine
17959	3731	Arch Clamp Foot Lifting Stud for 17957, 17964, 17965, 18431, 18432, 18460 and 18461.....
17960	3731	Arch Clamp Foot Plate for 18453.....
17963	3731	Feed Plate for 18453.....
Nos. 17964 to 17968 FOR 18449		
17964	3733	Arch Clamp Foot (left) with 17959.....
17965	3733	" " " (right) with 17959.....
17966	3733	" " " Plate.....
17967	3733	" " " Spring Connection.....
17968	3732	" " " Frame.....
17970	3740	Feed Plate for 18449.....
17975	5013	" " " 18436, obsolete.....
Nos. 17976 to 17984 FOR 18452		
17976	3737	Clamp Arm (lower) left.....
17977	3737	" " " (right).....
17978	3737	" " " Bracket.....
17979	3738	" " " (upper) left, with 17986 and 39257.....
17980	3738	Clamp Arm (upper) right, with 17986 and 39257.....
17981	3737	Clamp Arm (upper) Bracket.....
17982	3738	" Pressure Spring.....
17983	3737	" Spreader Lever.....
17984	3738	" " " Friction Washer..
17985	3738	" " " Hinge Stud for 18451.....
17986	3738	Clamp Spreader Stud for 17979 and 17980
17988	3737	Feed Plate (left) for 18452.....
17989	3737	" " (right) for 18452.....
17991	5019	Clamp Arm (lower) with two 17992, for 18446 and 18490, obsolete.....
17992	3740	Clamp Arm (lower) Hook for 17991 and 63811.....
17993	5019	Clamp Arm (upper) for 18446 and 18490, obsolete.....
17994	3740	Clamp Arm Bracket for 18446 and 18455, obsolete, use 39336.....

NO.	PLATE	NAME
17997	5004	Feed Cam Driving Worm Wheel with 453c, for 69-7 and 69-15 Machines.....
17998	3740	Feed Plate for 18446, obsolete.....
17999	3739	Clamp Arm with two 39257, for 18455 and 18491.....
*18351	—	Arm with 4449, 17844 and two 164E, for 69-5 Machine, obsolete.....
*18352	—	Cylinder for 69-5 to 69-15, 69-17 and 69-18 Machines.....
Nos. 18353 TO 18359 FOR ALL MACHINES EXCEPT 69-25		
18353	5006	Feed Across Connection with 18354 and two 175E.....
*18354	—	Feed Across Connection Cap for 18353...
18355	5008	" " " Knuckle Joint.....
18356	5006	" " " Regulator with 1952.....
18357	5008	" " " Hinge Stud.....
18358	5002	" " " Shaft.....
18359	5008	" " " Collar with two 200F..
18360	5008	" " " Crank (back) with 160E and 200c, for 69-5 to 69-7, 69-10 and 69-13 to 69-18 Machines.....
18361	5007	Feed Across Shaft Crank (back) Ball Stud for 69-5 to 69-7, 69-10 and 69-13 to 69-18 Machines.....
18362	5007	Feed Across Shaft Crank (front) with 160E and 18363, for all machines except 69-25.....
18363	5007	Feed Across Shaft Crank (front) Stud for 18362.....
18364	5007	Feed Across Shaft Crank (front) Stud Slide Block for all machines except 69-25.....
18365	—	Feed Plate Carrier Bar 18445 with 934b, 1195E, 1221c, 17743, 18366, 18390, two 55300 and four 17806, for 18446, 18455, 18490, 18491 and 69-5, 69-6, 69-15, 69-17 and 69-18 Machines.....
18366	5007	Feed Plate Carrier Bar Block for 18365 and 18451.....
18367	5007	Feed Plate Carrier Bar Block Cover for 18436, 18446, 18449, 18452, 18453, 18455, 18462, 18483, 18490, 18491 and 69-5, 69-6, 69-15, 69-17 and 69-18 Machines.....

NUMERICAL LIST OF PARTS

NO.	PLATE	NAME
18369	5006	Feed Regulator Bracket with 690d, 17732 and two 160d, for all machines except 69-25.....
18370	5000	Knife Bar with 18373 and two 17822, for all machines except 69-11 and 69-25.....
18371	5015	Knife Bar Cap.....
18372	5016	" " Connection with 17917.....
18373	5015	" " Rack for 18370, 18426 and 55240.....
18374	—	No. cancelled, order 17823.....
18375	5006	Knife Cam Lever Bracket for 1197, obsolete.....
18376	—	No. cancelled, order 17828.....
18377	5025	Shuttle Race Ring, obsolete.....
18378	5024	Cylinder End Cover with 7569, obsolete.....
18379	5008	" " Spring.....
18380	5019	Stop Cam Interlocking Rod Case Extension for 1255, obsolete.....
18381	5020	Throat Plate with 17871 and two 1208d, for flat buttons, for 55301 and 55318.....
18382	—	Throat Plate with 17924 and two 1208d, for round bottom buttons, for 55306.....
18383	—	No. cancelled.....
18384	5007	Feed Cam Pin.....
18385	5002	Oscillating Shaft for all machines except 69-19 and 69-25.....
18386	—	Oscillating Shaft Crank for 18387.....
18387	5017	Oscillating Shaft Crank complete for all machines except 69-25, Nos. 237r, 1519e, 15171 and 18386.....
18388	5008	Cylinder Block for all machines except 69-25.....
18389	5015	Knife (needle thread) for 55296.....
18390	5007	Feed Plate Carrier Bar Plate for 18365, 18438, 18448, 18451 and 18486.....
18391	—	No. cancelled, order 18395.....
18392	5003	Thread Take-up Cam 55302 with 446c, for all machines except 69-16 and 69-19.....
18393	5002	Thread Take-up Lever with 1822, for all machines except 69-16 and 69-19.....
18395	5004	Feed Cam with two each 1192c, 17874 and four 190d, for 69-5 Machine.....
18396	—	Feed Cam with two 1192c, three 17874 and six 190d, for 69-6 Machine.....
18397	—	Feed Cam with 17874 and two each 190d and 1192c, for 69-7 Machine.....

NUMERICAL LIST OF PARTS

NO.	PLATE	NAME
18398	—	Feed Cam with 17874 and two each 190d and 1192c, for 69-8 Machine.....
18399	—	Feed Cam with two each 1192c, 17874 and four 190d, for 69-9 and 69-10 Machines.....
18401	—	Feed Cam with 17874 and two each 190d and 1192c, for 69-11 Machine.....
18402	—	Feed Cam with two each 1192c, 17874 and four 190d, for 69-12 Machine.....
18403	—	Feed Cam with two 1192c, three 17874 and six 190d, for 69-13 Machine.....
18404	—	Feed Cam with two each 1192c, 17874 and four 190d, for 69-14 Machine.....
18405	—	Feed Cam with 17874 and two each 190d and 1192c, for 69-15 Machine.....
18406	—	Feed Cam with two each 1192c, 17874 and four 190d, for 69-16 Machine.....
18411	—	Shuttle Race Body for 18414 and 18430.....
18412	5026	" " Ring for 18414, obsolete.....
18413	5018	" " Spring for 18414, 18430 and 55272.....
18414	5026	Shuttle Race (flexible) complete for 18378, Nos. 662d, 2523, 18411, 18412, 21623 and two each 1289d and 18413, obsolete.....
18415	5007	Feed Cam Driving Worm with 1441c and 1442c, for 69-5, 69-6, 69-8 to 69-11, 69-13, 69-14, 69-16 and 69-25 Machines.....
18416	5004	Feed Cam Shaft for all machines except 69-25.....
18417	5004	Feed Cam Shaft Bracket for all machines except 69-25.....
18418	5019	Stop Cam Interlocking Rod Case Extension for 1300 for 18425, obsolete.....
18419	—	Cylinder Base Plate with two 453c, for 18424.....
18420	5005	Cylinder Base Plate Hinge Connection for 18424 and 55260.....
18421	5009	Feed Across Shaft Crank (back) with 160e and 200c, for 69-8, 69-9, 69-11, 69-12 and 69-19 Machines.....
18422	5009	Feed Across Shaft Crank (back) Ball Stud for 69-8, 69-9 and 69-11 Machines.....
18423	5005	Cylinder Base Plate Hinge Connection Hinge Pin for 18424 and 55260.....

NUMERICAL LIST OF PARTS

NO.	PLATE	NAME
18424	5022	Cylinder Base Plate (hinged) complete for all machines except 69-25, Nos. 18419, two each, 18420, 18423, three wood screws $1\frac{1}{4}$ in. No. 12 and four 134d (Attachments and Accessories)...
18425	—	Stop Cam Interlocking Rod Case Bracket complete for all machines except 69-8 and 69-25, Nos. 1182E, 1196c, 1204E, 1254c, 1262c, 1318d, 1508E, 1662c, 17853, 17855, 17857, 17859 to 17864, 17872, 17873, 18418, 39222 to 39224 and two each 898d, 1255d and 1300d, obsolete, use 18442.
18426	5000	Knife Bar with 18373 and two 17822, for 69-11 Machine.
18427	5001	Cylinder End Cover with 18428, 18444 and three 4604.
18428	5008	Cylinder End Cover Bracket for 18427.
18429	5018	Shuttle Race Ring for 18430.
18430	5018	Shuttle Race (flexible) complete for all machines except 69-16 and 69-19, Nos. 662d, 2523, 18411, 18429, 21623 and two each 1289d and 18413.
18431	5011	Arch Clamp Foot (left) with 17959, for 18436.
18432	5011	Arch Clamp Foot (right) with 17959, for 18436.
Nos. 18433 TO 18435 FOR 18436 AND 18462		
18433	5011	Arch Clamp Foot Plate.
18434	5011	" " " Spring Connection.
18435	5010	" " Frame.
18436	—	Arch Clamp complete for 69-9 Machine, Nos. 1654c, 18367, 18431 to 18435, 18438, 18459, 39302, two each 161d, 1175j, 14079 and five 217j.
*18437	5012	Feed Plate Carrier Bar for 18438.
18438	—	" " " " 18437 with 934d, 1195E, 1221c, 17743, 18390, 55295, two 55300 and four 17806, for 18436, 18453 and 18462.
*18439	—	Arm with 4449, 17844 and two 164E, for all machines except 69-8 and 69-25.
*18440	5003	Stop Cam Interlocking Rod Case with 18443 and two 193F, for 18442 and 18458, obsolete.

NUMERICAL LIST OF PARTS

NO.	PLATE	NAME
18441	5003	Stop Cam Interlocking Rod Case Bracket for 18442, obsolete.
18442	—	Stop Cam Interlocking Rod Case Bracket complete for all machines, except 69-8 and 69-25, Nos. 1182E, 1196c, 1204E, 1254c, 1262c, 1318d, 1508E, 1662c, 17853, 17855, 17859 to 17864, 17872, 17873, 18440, 18441, 39222, 39223 and two each 898p and 1255d, obsolete.
18443	5015	Stop Cam Interlocking Rod Case Wearing Block for 18440 and 18492.
18444	5008	Cylinder End Cover Bracket Hinge Pin for 18427.
*18445	5002	Feed Plate Carrier Bar for 18365.
18446	—	Clamp complete for 69-7 and 69-12 Machines, Nos. 1267d, 1654c, 9330, 17994, 18365, 18367, 39304, 63811 and 63812, obsolete, use 18490.
*18447	5012	Feed Plate Carrier Bar for 18448.
18448	—	" " " " 18447 with 934d, 1195E, 1221c, 17743, 18390, 55295, two 55300 and four 17806, for 18449.
18449	—	Arch Clamp complete for 69-8 Machine, Nos. 1654c, 17964 to 17968, 17970, 18367, 18448, 39302, two each 1175j, 1177d, 14079 and five 217j.
*18450	5012	Feed Plate Carrier Bar for 18451.
18451	—	" " " " 18450 with 934d, 1221c, 17743, 17985, 18366, 18390 and two 55300, for 18452.
18452	—	Clamp complete for 69-10 Machine, Nos. 181j, 957k, 1177d, 1178j, 14008, 17713, 17976 to 17984, 17988, 17989, 18367, 18451, two 7401 and four each 90; and 17806.
18453	—	Arch Clamp complete for 69-11 Machine, Nos. 1175j, 1654c, 17957, 17960, 17963, 18367, 18438, 39250, 39303, two each 181d, 14079 and five 217j.
18454	—	Throat Plate with 39213 and two 1208d, for 55310.
18455	—	Clamp complete for 69-13 Machine, Nos. 1267d, 1654c, 17994, 17999, 18365, 18367 and 39258, obsolete, use 18491.
18456	5016	Feed Across Shaft Crank (back) Ball Stud for 69-12 and 69-19 Machines.

NO.	PLATE	NAME
*18457	—	Arm with 4449, 17844 and two 164E, for 69-8 Machine.....
18458	—	Stop Cam Interlocking Rod Case Bracket complete for 69-8 Machine, Nos. 1182E, 1196C, 1204E, 1254C, 1262C, 1318D, 1508E, 1662C, 17853, 17855, 17859 to 17864, 17872, 17873, 18440, 39222, 39223, 39288 and two each 898D and 1255D, obsolete.....
18459	5011	Feed Plate for 18436.....
18460	5027	Arch Clamp Foot (left) with 17959, for 18462, obsolete.....
18461	5027	Arch Clamp Foot (right) with 17959, for 18462, obsolete.....
18462	—	Arch Clamp complete for 69-14 Machine, Nos. 1654C, 18367, 18433 to 18435, 18438, 18460, 18461, 18463, 39302, two each 181D, 1175J, 14079 and five 217J, obsolete.....
18463	5025	Feed Plate for 18462, obsolete.....
Nos. 18464 TO 18466 FOR 18467 AND 63929		
18464	3764	Button Clamp (left) with 9311 and 17723
18465	3764	" " (right) with 9311 and 17723
18466	3764	" " Stop with two 17720.....
18467	—	Button Clamp (universal) complete, for 26 to 55 line buttons, for 69-15 Machine, Nos. 207J, 1180R, 1182J, 7071, 17717, 17718, 18464 to 18466, 39240, 39242, 39243, 39244 or 39246, 39245 or 39247, 50237K and two each 229J, 1175J and 1183J, obsolete, use 63929.....
18468	3764	Feed Plate for 69-15 Machine.....
18469	5029	" Regulator Bracket with 690D, 39310 and two 160D, for 69-15 Machine.....
18470	5028	Knife Cam Lever Bracket with 177D.....
18471	3759	" " " " Hinge Screw Bushing for 18472.....
*18472	—	Knife Cam Lever Hinge Screw Bushing 18471 with 50029C.....
18473	5030	Arch Clamp Foot (left) for 18474.....
18474	5030	" " " " 18473 with 219K and 18478, for 18483.....
18475	5030	Arch Clamp Foot (right) for 18476.....
18476	5030	" " " " 18475 with 219K and 18479, for 18483.....
18477	5030	Arch Clamp Foot Plate for 18483.....

NO.	PLATE	NAME
18478	—	Arch Clamp Foot Shank (left) with 39307, for 18474.....
18479	—	Arch Clamp Foot Shank (right) with 39307, for 18476.....
18480	3739	Arch Clamp Foot Spring (heavy) for 69-14 and 69-16 Machines.....
18481	3739	Arch Clamp Foot Spring (light) for 18483
18482	5031	" " Frame for 18483.....
18483	—	Arch Clamp complete for 69-14 and 69-16 Machines, Nos. 1654C, 18367, 18474, 18476, 18477, 18482, 18484, 18486, two each 181D, 1229F, 1547J, 14079, 18481 and four 190J.....
18484	5030	Feed Plate for 18483.....
*18485	5012	" " Carrier Bar for 18486.....
18486	—	" " " " 18485 with 810D, 934D, 1195E, 1221C, 18390, 18488, 18489, 55295, two 55300 and four 17806, for 18483.....
18487	5029	Feed Regulator with 1953, for 69-14 and 69-16 Machines.....
18488	3759	Feed Regulator Post for 18486.....
18489	3759	" " " Guide for 18486.....
18490	—	Clamp complete for 69-7, 69-12 and 69-19 Machines, Nos. 1654C, 9330, 18365, 18367, 39304, 39336, 63811 and 63812..
18491	—	Clamp complete for 69-13 Machine, Nos. 1654C, 17999, 18365, 18367, 39258 and 39336.....
18492	5028	Stop Cam Interlocking Rod Case with 18443 and two 193E, for 55285.....
18493	—	Stop Cam Interlocking Rod Case Bracket 55304 with 39343, 39344 and two 1186D, for all machines except 69-8 and 69-25
18494	—	Stop Cam Interlocking Rod Case Bracket 55305 with 39343, 39344 and two 1186D, for 69-8 Machine.....
Nos. 18495 TO 18497 FOR 69-25 MACHINE		
*18495	—	Arm and Cylinder (solid) with 4449, 55217 and three 1177D.....
18496	5033	Arm Shaft.....
18497	5029	" " Bushing (back).....
18498	5033	Belt Cover.....
18499	5034	Button Clamp Arm with 17720, for 55213
18500	5034	" " Head with two 641C, for 69-25 Machine.....

NO.	PLATE	NAME
19793	5015	Knife Cam Lever Slide Steady Pin for 39237 and 39329.....
21561	5017	Shuttle, 1 $\frac{1}{4}$ in. diam., for all machines except 69-16 and 69-19, Nos. 2996, 15277 and 21562.....
21562	5017	Shuttle Body for 21561.....
21623	5018	" Race Cap for 18414 and 18430.....
21629	3718	Needle Bar Connecting Stud with 155c, for all machines except 69-25.....
21678	5009	Hand Stop Lever Rod Collar with 1019c, for 69-8 Machine.....
22003	5023	Wrench for 1651 (Attachments and Accessories).....
23219	3709	Clamp Spring Steady Pin for 17906.....
23227	3705	Button Clamp Spring Steady Pin for 17901.....
23373	3741	Belt Cover, obsolete.....
23536	5039	Table Belt Guide Belt Guide with two 163E, for 39709 and 39716.....
23538	5039	Table Belt Guide Pulley for 39709 and 39716.....
24122	5009	Hand Stop Lever Rod Spring for 69-8 Machine.....
25086	5023	Wrench for 25285.....
25285	—	Stand (iron work) complete, for electric motor, Nos. 25086, 46618, 46667, two each 780E, 46522 and four 748E.....
25350	3722	Table Belt Guide Pulley Cotter Pin for 17897, obsolete.....
26026	5023	Screw Driver, machine (Attachments and Accessories).....
26485	5023	Screw Driver, shuttle tension (Attachments and Accessories).....
27305	3781	Bobbin Winder Spindle for 41713.....
27321	5041	" " Frame for 41604 and 41713.....
27326	3781	" " Stop Latch for 41713.....
27328	5041	" " " 41604.....
27538	5041	" " Spindle with 15072, for 41604.....
27623	2837	Thread Unwinder Spool Pin for 41531.....
27662	5023	Wrench for 1508 (Attachments and Accessories).....
27739	2837	Thread Unwinder Thread Cone (wood) for 41533.....
27916	3731	Bobbin Winder Brake (leather) for 41598.....
27940	2837	Thread Unwinder Spool Stand with 453c, for 41533.....
28084	3781	Bobbin Winder Brake Rivet for 41598.....

NO.	PLATE	NAME
36565	4079	Oiler (copper plated) with 36566 (Attachments and Accessories).....
36566	4079	Oiler Spout, 9 in. long, with 120117, for 36565.....
39201	5019	Belt Shifter, obsolete.....
39202	5035	Stop Cam Interlocking Rod Case, obsolete.....
39203	3718	Needle Bar Connecting Link.....
39204	5028	Thread Take-up Cam 63749 with 446c, for 69-16 and 69-19 Machines.....
39205	5023	Guide with 460c, for 17953.....
39206	3731	Arch Clamp Foot Lifter with 17866, for 69-11 Machine.....
39211	5005	Feed Cam Driving Worm with 1441c and 1442c, for 69-12 and 69-17 to 69-19 Machines.....
39212	5002	Feed Cam Driving Worm Wheel with 453c for 69-12 and 69-17 to 69-19 Machines.....
39213	3731	Throat Plate Needle Hole Bushing for 18454.....
		Nos. 39218 to 38220 for 39221.....
39218	5022	Table Belt Guide Belt Guide with two 163E.....
39219	5022	Table Belt Guide Pulley Shaft (long) with 17896.....
39220	5022	Table Belt Guide Pulley Shaft (short) with 17896.....
39221	—	Table Belt Guide complete for all machines except 69-25, Nos. 17892, 39219, 39220, two each 17893, 39218 and three wood screws 1 $\frac{1}{4}$ in. No. 12.....
39222	5001	Belt Shifter for 18425, 18442, 18458 and 55285.....
39223	5008	Belt Shifter Clamp for 18425, 18442, 18458 and 55285.....
39224	5024	Stop Cam Interlocking Rod Case for 18425, obsolete.....
39231	5005	Feed Cam Driving Worm with 1441c and 1442c, for 69-7 and 69-15 Machines.....
39235	5006	Knife Cam Lever Body for 39237 and 39409.....
39236	5015	Knife Cam Lever Slide with 1964, for 39237, obsolete, use 39460.....
39237	5006	Knife Cam Lever complete, Nos. 1174D, 19793, 39235 and 39236, obsolete, use 39329.....

NUMERICAL LIST OF PARTS

NO.	PLATE	NAME
39238	3747	Button Clamp (left) with 9311 and 17723, for 39249 and 63928.....
39239	3747	Button Clamp (right) with 9311 and 17723, for 39249 and 63928.....
39240	3747	Button Clamp Arm with 17714 and 63788, for 18467 and 39249, obsolete.....
39241	3748	Button Clamp Pressure Spring for 63928
39242	3748	" " Spreader for 18467, 39249, 63928 and 63929.....
39243	3748	Button Clamp Spreader Spring for 18467, 39249 and 55213.....
Nos. 39244 to 39247 for 18467, 39249, 63928 and 63929		
39244	3747	Button Clamp Spring (left) for flat buttons
39245	3747	" " " (right) for flat buttons
39246	3748	" " " (left) for stud back buttons.....
39247	3748	Button Clamp Spring (right) for stud back buttons.....
39248	3748	Button Clamp Stop with two 17720, for 39249 and 63928.....
39249	3751	Button Clamp (universal) for 10 to 50 line thin buttons, for 69-5, 69-6, 69-17 and 69-18 Machines, Nos. 207j, 1180j, 1182j, 7071, 17717, 17718, 39238 to 39240, 39242, 39243, 39244 or 39246, 39245 or 39247, 39248, 50237k and two each 229j, 1175j and 1183j, obsolete, use 63928.....
39250	5010	Arch Clamp Frame for 18453.....
39257	5009	Clamp Arm Hook for 17999.....
39257	5009	" " (upper) Hook for 17979 and 17980.....
39258	5014	Feed Plate (thin) for 18455 and 18491....
39276	5009	Needle Bar Thread Nipper Lever Spring for all machines except 69-25.....
Nos. 39283 to 39287 for 69-8 MACHINE		
39283	5009	Hand Stop Lever.....
39284	5000	" " " Rod.....
39285	5009	" " " " Connection.....
39286	5009	" " " " Guide Stud (back)
39287	5009	" " " " " " (front)
39288	5003	Stop Cam Interlocking Rod Case Bracket for 18458, obsolete.....
39290	5001	Belt Cover Bracket with 184e and 17741

NUMERICAL LIST OF PARTS

NO.	PLATE	NAME
*39295	—	Shuttle Body with 398e, 2082, 2084, 2211 and two 2212, for 39296.....
39296	3702	Shuttle complete for 69-16 and 69-19 Machines, Nos. 2073, 2076, 39295 and 44001.....
39297	5016	Knife Bar Driving Lever with 190D, 1420E, 17919 and 39298.....
39298	5016	Knife Bar Driving Lever Lock Stud for 39297.....
39302	3731	Arch Clamp Foot Spring for 18436, 18449 and 18462.....
39303	3731	Arch Clamp Foot Spring for 18453.....
39304	5014	Feed Plate for 18446 and 18490.....
39307	5030	Arch Clamp Foot Lifting Stud for 18478 and 18479.....
*39310	—	Feed Regulator Bracket Cap for 18469....
39312	5029	" " with 1953, for 69-15 Machine
39313	3759	" " Swivel for 69-15 Machine..
39329	5029	Knife Cam Lever complete, Nos. 19793 and 39409.....
39330	3759	Knife Cam Lever Slide with 1980, for 39460.....
39331	3759	Knife Cam Lever Slide Screw Washer for 39460.....
Nos. 39333 to 39335 for 39336		
39333	3761	Clamp Arm Bracket.....
39334	3761	" " " Hinge Block.....
39335	3761	" " " Screw Plate.....
39336	3761	Clamp Arm Bracket (adjustable) complete for 18490 and 18491, Nos. 129j, 1178j, 1300D, 1654c, 39333 to 39335 and 50048j.....
39340	5027	Button Clamp Spring for 39341.....
39341	—	" " " 39340 with 39342, for flat or stud back buttons, for 17904
39342	5027	Button Clamp Spring Plate for 39341....
39343	5028	Stop Cam Interlocking Rod Case Spring (flat) for 18493 and 18494.....
39344	3759	Stop Cam Interlocking Rod Case Spring Bracket with 430c and 1520E, for 18493 and 18494.....
39346	5028	Stop Cam Interlocking Rod Case Bracket for 55247 and 55304.....
39348	5028	Stop Cam Interlocking Rod Case Bracket for 55305.....

NUMERICAL LIST OF PARTS

NO.	PLATE	NAME
39350	5029	Needle Bar Thread Nipper Driving Léver (adjustable) with 39351 and two 335D
39351	3759	Needle Bar Thread Nipper Driving Léver Extension for 39350
39352	5029	Needle Bar Thread Nipper Driving Léver Spring
39362	—	Feed Plate (thick) for 69-13 Machine
39409	—	Knife Cam Léver Body 39235 with 39460, for 39329
39455	5037	Thread Wiper Body Wire for 69-25 Machine
39460	—	Knife Cam Léver Slide 39330 with 1255D and 39331, for 39409
39486	—	Throat Plate Needle Hole Bushing (large needle hole) for 55314
39487	3702	Shuttle Driver with two 457c, for 69-16 and 69-19 Machines
39489	7008	Protector Arm with 39490, for 63753
39490	—	Blade for 39489
		Nos. 39491 to 39494 for 63753
39491	7008	Protector Bracket with two each 426c and 448c
39492	7009	Protector Crank with 160c
39493	7009	Bracket with 1120c and two 454c
39494	7008	Protector Rod
39495	7009	Connection for 39498
39496	7008	Sleeve for 63753
39497	7009	Spring for 63753
39498	—	Protector (front of needle) complete for all machines except 69-25, Nos. 39495, 63753 and two each 176D and 50351D
39569	—	Treadle Chain, 45 in. long, with 39575 and 39576, for foot lifter, for 69-25 Machine
39571	5040	Treadle Chain Guide Pulley for 55264 and 55265
39575	5037	Treadle Chain Hook (lower) for 39569
39576	5037	Hook (upper) for 39569
39708	5039	Table Belt Guide Pulley Shaft with 858c, for 39709 and 39716
39709	5039	Table Belt Guide (single, right) complete for 69-25 Machine, Nos. 14229, 23536, 23538, 39708 and four wood screws 1¼ in. No. 12 R. H. B.

NUMERICAL LIST OF PARTS

NO.	PLATE	NAME
39716	5039	Table Belt Guide (single, left) complete for 69-25 Machine, Nos. 14229, 23536, 23538, 39708 and four wood screws 1¼ in. No. 12 R. H. B.
41400	5023	Machine Rest Pin, wood (Attachments and Accessories)
41514	2837	Thread Unwinder Spool Weight, 4 in. diam., with 41515, for 41533
41515	5037	Thread Unwinder Spool Weight Centre Pin for 41514
41530	2837	Thread Unwinder Spool Rest for 60455
41531	—	“ “ “ “ 60455 with two 27623, for 41533
41533	2837	Thread Unwinder complete, for two large spools or two large cones of thread, Nos. 27940, 41531, 41631, 41640, two each 27739, 41514 and three wood screws 1 in. No. 12
41569	5037	Bobbin Winder Thread Eyelet for 41603
41569	5037	Thread Unwinder Thread Guard Eyelet for 41631
41598	5041	Bobbin Winder Base with 27916 and two 28084, for 41604 and 41713
41599	5041	Bobbin Winder Bracket for 41605
41600	5041	Pulley with 155c, for 41604 and 41713
41601	5041	Bobbin Winder Tension Bracket with 624c, for 41602
41602	—	Bobbin Winder Tension Bracket complete for 41605, Nos. 5989, 10145, 41601 and 41603
41603	5041	Bobbin Winder Thread Eyelet Rod with 41569, for 41602
41604	5041	Bobbin Winder for 41605 and 41716, Nos. 35D, 1620, 27321, 27328, 27538, 41598, 41600, 41825 and 50356D
41605	—	Bobbin Winder (swinging automatic, left hand) complete for 2996 for 69-25 Machine, Nos. 41599, 41602, 41604, two 1177D and three 1186c
41631	2837	Thread Unwinder Thread Guard with 208E and two 41569, for 41533
		Nos. 41637 to 41639 for 41640
41637	2837	Thread Unwinder Thread Guard Rod (lower)

NO.	PLATE	NAME
41638	2837	Thread Unwinder Thread Guard Rod (upper)
41639	2837	Thread Unwinder Thread Guard Rod Coupling with two 456c
41640	—	Thread Unwinder Thread Guard Rod complete, 30 in. long, for 41533, Nos. 41637 to 41639
41713	3780	Bobbin Winder for 41714, Nos. 35d, 1620r, 27305, 27321, 27326, 41598, 41600, 41825 and 50356d
41714	—	Bobbin Winder (swinging automatic, left hand) complete for 2073 for 69-16 and 69-19 Machines, Nos. 161d, 41713, 60770 and two 1186c
41715	5023	Bobbin Winder Bracket for 41714 and 41716
41716	—	Bobbin Winder (swinging automatic, left hand) complete for 2996 for 69-5 to 69-15, 69-17 and 69-18 Machines, Nos. 161d, 41604, 60770 and two 1186c
41825	3781	Bobbin Winder Frame Spring for 41604 and 41713
43808	5042	Bobbin Winder Tension Spring for 60770
*44001	—	Shuttle Cover 2075 with 112d, 466H, 2078, 2080, 2086 and 2090, for 39296
46522	7219	Leg for 25285
46614	7219	Motor Treadle Bracket (left) for 46616
46614	7219	Starting Treadle Bracket (left) for 46616
46615	7219	Motor Treadle Bracket (right) for 46616
46615	7219	Starting Treadle Bracket (right) for 46616
46616	7219	Motor Treadle complete for 46618, Nos. 4879, 4881 to 4883, 46614 and 46615
46616	7219	Starting Treadle complete for 46618, Nos. 4879, 4881 to 4883, 46614 and 46615
46617	7219	Treadle Support for 46618
46618	—	" " 46617 with two 46616 and four 1177E, for 25285
46667	7219	Brace for 25285
50018F	5021	Knife Holder Pinion Stud Bracket Screw for 55301, 55306, 55310, 55315 and 55318
50029c	3759	Knife Cam Lever Hinge Screw for 18472
50048r	3761	Clamp Arm Bracket Hinge Screw (eccentric) for 39336
50237x	3705	Button Clamp Spreader Lever Hinge Screw for 17898, 17904, 18467, 39249, 55213, 63928 and 63929

NO.	PLATE	NAME
50333c	5042	Arm Shaft Bushing (back) Adjusting Screw
50351d	7009	Protector Bracket Screw for 39498
50356d	5042	Bobbin Winder Frame Hinge Screw for 41604 and 41713
52598	7009	Protector Crank Hinge Stud for 63753
Nos. 55201 TO 55220 FOR 69-25 MACHINE		
55201	5034	Button Clamp Head Plate
55202	—	" " " Support for 55203
55203	5034	" " " " 55202 with 55204
55204	5034	Button Clamp Head Support Stud for 55203
55205	5033	Button Clamp Lifting Lever with 910c, obsolete
55206	5029	Button Clamp Lifting Lever Bracket with 1143c
55207	5037	Button Clamp Lifting Lever Hinge Pin
55208	5035	" " " " Spring, obsolete
55209	5033	Button Clamp Shaft
55210	5035	" " " Bracket with two 641c
55211	5035	Button Clamp Shank with 1993, for 55213
55212	5034	" " Spring for 55213
55213	—	Button Clamp (universal) complete, Nos. 217K, 1180J, 1182J, 17706, 17707, 17716 to 17718, 17722, 18499, 39243, 50237K, 55211, 55212, two each 1175E, 1183J and three 236K
55214	5036	Cylinder Block
55215	5033	" Lower Cover
55216	5035	Feed Cam Shaft
*55217	—	" " " Flanged Bushing for 18495
55218	5036	" Plate with 55219 and two 757D
55219	5036	" " Bushing for 55218
*55220	5033	" " Carrier Bar for 55236
55225	—	" Cam with two 1192c, three 17874 and six 190d, for 69-25 Machine
Nos. 55236 TO 55268 FOR 69-25 MACHINE		
55236	—	Feed Plate Carrier Bar 55220 with 914F, 1195E, 2049, 17743, 55237 and four 17806
55237	5036	Feed Plate Carrier Bar Block for 55236
55238	5029	" Regulator Bracket with 55239 and two 160D

NO.	PLATE	NAME
*55239	—	Feed Regulator Bracket Cap for 55238...
55240	5033	Knife Bar with 18373 and two 17822...
55241	5035	Needle Bar with 237f.....
55242	5036	" " Thread Nipper Lever Spring
55243	5033	" " " " Rod.....
55244	5033	Oscillating Shaft.....
55245	—	" " Crank for 55246.....
55246	5036	Oscillating Shaft Crank complete, Nos. 1519e, 15171, 55245 and two 1253c....
55247	—	Stop Cam Interlocking Rod Case Bracket complete, Nos. 181e, 357c, 1182e, 1196c, 1204e, 1254c, 1262c, 1508e, 1650c, 1662c, 17853, 17859, 17861, 17862, 17872, 17873, 39346, 55248, 55285 and two 898d.....
55248	5035	Stop Cam Interlocking Rod Case Spring (flat) for 55247.....
55249	5036	Tension Releasing Lever with 17835.....
55250	5037	Thread Wiper Body.....
55251	5037	" " " " Arm with 17866.....
55252	5037	" " " " Support for 55253.....
55253	5037	" " " " Bracket with 55252.....
55254	—	No. cancelled, order 39455.....
55255	5035	Button Clamp Shank with 1993, for 55257
55256	5037	" " Spring for 55257.....
55257	—	Button Clamp (end opening) complete, Nos. 1208j, 1656j, 17926, 55255 and 55256.....
55258	5040	Button Tray with two wood screws 1 in. No. 10 (Attachments and Accessories)
55259	—	Cylinder Base Plate with two 453c, for 55260.....
55260	5039	Cylinder Base Plate (hinged) complete, Nos. 55259, two each 134d, 18420, 18423 and four wood screws 1¼ in. No. 12 (Attachments and Accessories).....
55261	—	Treadle Chain Guide Bracket with two 457c, for 55264, obsolete.....
55262	5040	Treadle Chain Guide Bracket for 55265...
55263	5005	" " " Pulley Pin for 55264 and 55268.....
55264	—	Treadle Chain Guide complete, for foot lifter, Nos. 55261, two each 39571, 55263 and three wood screws 1¼ in. No. 14, obsolete, use 55268.....

NO.	PLATE	NAME
55265	5040	Treadle Chain Guide complete, for starting lever, Nos. 55262 and two each 1064d, 39571 and wood screws 1¼ in. No. 12 R. H. B.....
55266	5040	Treadle Chain Guide Bracket with two 457c, for 55268.....
55267	5040	Treadle Chain Guide Pulley for 55268...
55268	5040	Treadle Chain Guide complete, for foot lifter, Nos. 55266, two each 55263, 55267 and three wood screws 1¼ in. No. 14...
*55269	—	Cylinder for 69-16 and 69-19 Machines..
55270	—	Shuttle Race Body for 55272.....
55271	5032	" " Ring for 55272.....
55272	5032	Shuttle Race complete for 69-16 and 69-19 Machines, Nos. 55270, 55271 and two each 1289d and 18413.....
Nos. 55273 to 55277 for 69-25 MACHINE		
55273	5029	Face Plate for 55274.....
55274	—	Face Plate complete, Nos. 448c, 600c, 1560c, 2103, 2105, 2107, 2124, 2127, 55273 and two each 233d and 2102....
55275	5036	Needle Bar Connecting Stud with two 175d.....
55276	—	Button Clamp Lifting Lever with 910c...
55277	—	" " " " Spring.....
*55278	—	Oscillating Rock Shaft complete for all machines except 69-19, Nos. 1513j, 6022 and 6489.....
*55285	—	Stop Cam Interlocking Rod Case 18492 with 1318d, 17855, 17863, 17864, 39222, 39223 and two 1255d, for 55247, 55304 and 55305.....
55295	5042	Feed Plate Carrier Bar Block for 18438, 18448 and 18486.....
*55296	—	Knife Holder 17825 with 1198c, 17808, 17829 and 18389, for 55301, 55306 55310 and 55315.....
55300	5042	Feed Plate Carrier Bar Block Steady Pin for 18365, 18438, 18448, 18451 and 18486.....
*55301	—	Throat Plate 18381 with 1698c, 17828, 50018f and 55296, for 69-5 to 69-10, 69-12 to 69-15, 69-17, 69-18 and 69-25 Machines.....
*55302	—	Thread Take-up Cam for 18392.....

NUMERICAL LIST OF PARTS

NO.	PLATE	NAME
*55304	—	Stop Cam Interlocking Rod Case Bracket complete for 18493, Nos. 1182E, 1196c, 1204E, 1254c, 1262c, 1508E, 1662c, 17853, 17859, 17861, 17862, 17872, 17873, 39346, 55285 and two 898D...
*55305	—	Stop Cam Interlocking Rod Case Bracket complete for 18494, Nos. 1182E, 1196c, 1204E, 1254c, 1262c, 1508E, 1662c, 17853, 17859, 17861, 17862, 17872, 17873, 39348, 55285 and two 898D.....
55306	—	Throat Plate 18382 with 1698c, 17828, 50018F and 55296, for 69-5 to 69-10, 69-12 to 69-15, 69-17 and 69-18 Machines.....
55308	—	Feed Cam with two each 1192c, 17874 and four 190D, for 69-17 Machine.....
55309	—	Feed Cam with two 1192c, four 17874 and eight 190D, for 69-18 Machine.....
55310	—	Throat Plate 18454 with 1698c, 17828, 50018F and 55296, for 69-11 Machine..
55314	—	Throat Plate with 39486 and two 1208D, for 55315.....
55315	—	Throat Plate 55314 with 1698c, 17828, 50018F and 55296, for 69-5 to 69-10, 69-12 to 69-15, 69-17 and 69-18 Machines.....
55317	—	Knife Holder 17825 with 1198c, 17807, 17808 and 17829, for 55318.....
55318	—	Throat Plate 18381 with 1698c, 17828, 50018F and 55317, for 69-16 and 69-19 Machines.....
56812	—	Oscillating Rock Shaft Hinge Pin 3052 with 1513J, for 16806.....
56864	5042	Treadle Chain Hook (large) for 13351....
56865	5042	“ “ “ (small) for 13351....
60455	—	Thread Unwinder Spool Rest 41530 with 1149c and two 155c, for 41531.....
60769	3780	Bobbin Winder Tension Bracket for 60770
60770	3780	Bobbin Winder Tension Bracket complete for 41714 and 41716, Nos. 419E, 1562J, 8422, 9780, 43808, 60769 and two 2455
*63736	—	Face Plate 17724 with 2105, for 17725...
*63749	—	Thread Take-up Cam for 39204.....
63753	—	Protector (front of needle) for 39498, Nos. 1099F, 39489, 39491 to 39494, 39496, 39497, 52598 and two 15261.....

NUMERICAL LIST OF PARTS

NO.	PLATE	NAME
63788	7205	Button Clamp Arm Hook for 17927, 39240 and 63927.....
63788	7205	Clamp Arm Hook for 17908 and 17947...
63811	7205	“ “ (lower) with two 17992, for 18446 and 18490.....
63812	7205	Clamp Arm (upper) for 18446 and 18490
63927	7205	Button Clamp Arm with 17714 and 63788, for 63928 and 63929.....
63928	—	Button Clamp (universal) complete, for 10 to 50 line thin buttons, for 69-5, 69-6, 69-17 and 69-18 Machines, Nos. 1180J, 1181J, 1182J, 1183J, 17717 to 17719, 39238, 39239, 39242, 39244 or 39246, 39245 or 39247, 39248, 50237K, 63927 and two each 229J and 1175J.....
63929	—	Button Clamp (universal) complete, for 26 to 55 line buttons, for 69-15 Machine, Nos. 1180J, 1181J, 1182J, 1183J, 17717 to 17719, 18464 to 18466, 39242, 39244 or 39246, 39245 or 39247, 50237K, 63927, two each 229J and 1175J.....
120117	5023	Oiler Spout Washer (leather) for 36566...

PLATE 2837 -ONE-FOURTH SIZE

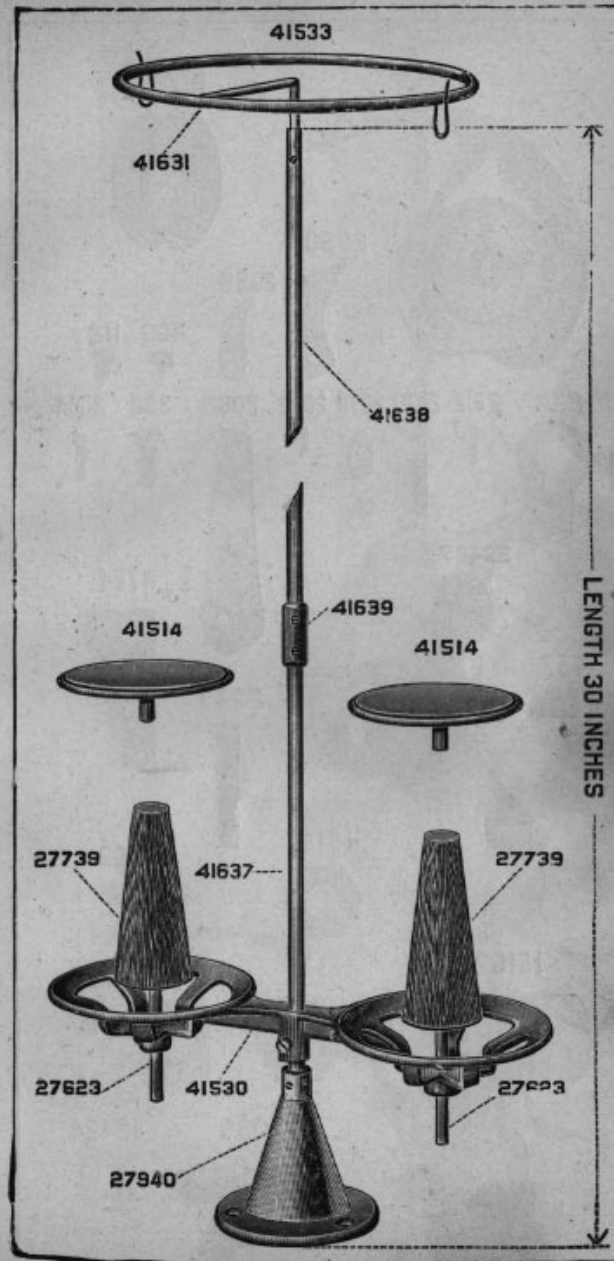
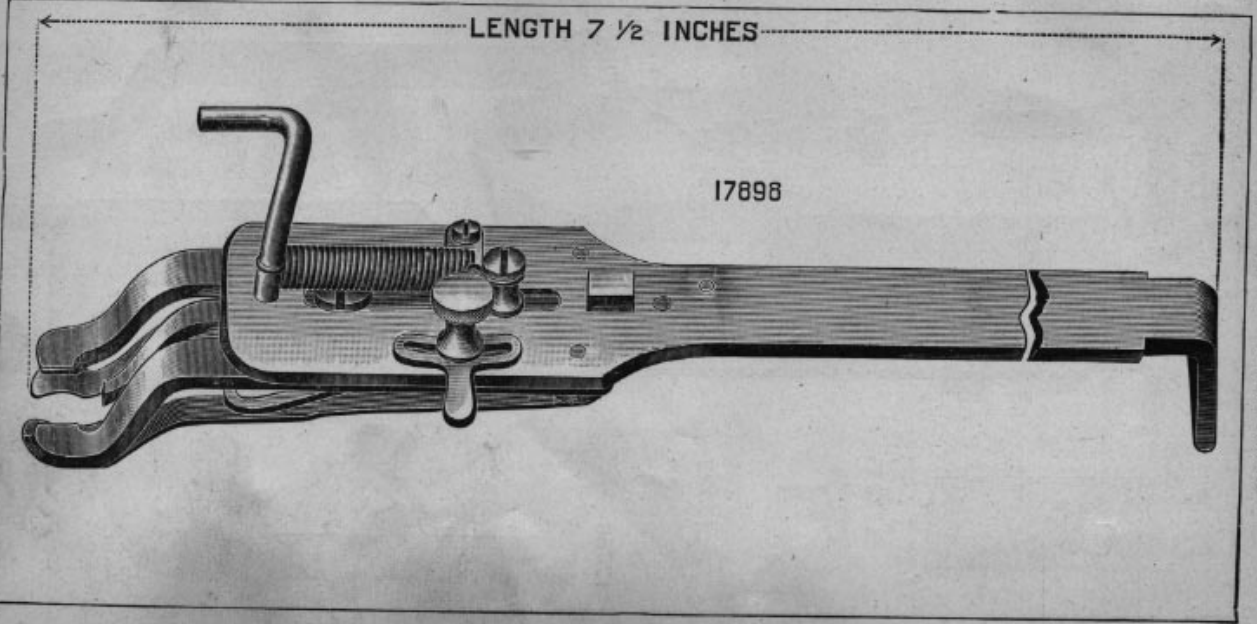

PLATE 3702—FULL SIZE





LENGTH 7 1/2 INCHES

17898

PLATE 3708—FULL SIZE

PLATE 3704—FULL SIZE

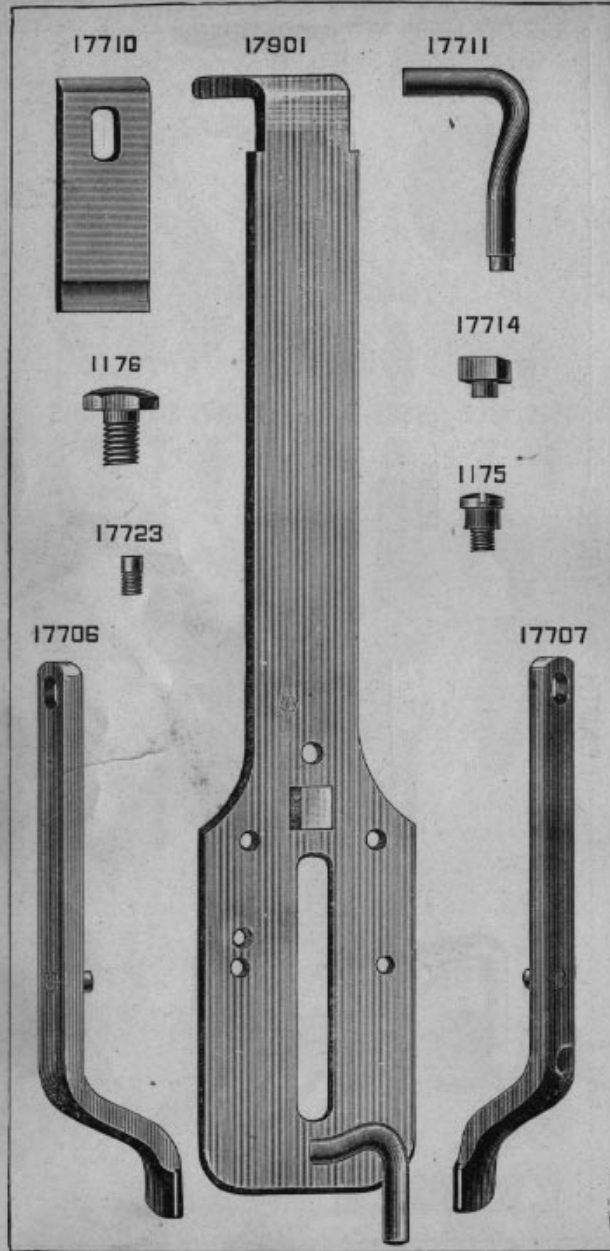

PLATE 3705—FULL SIZE

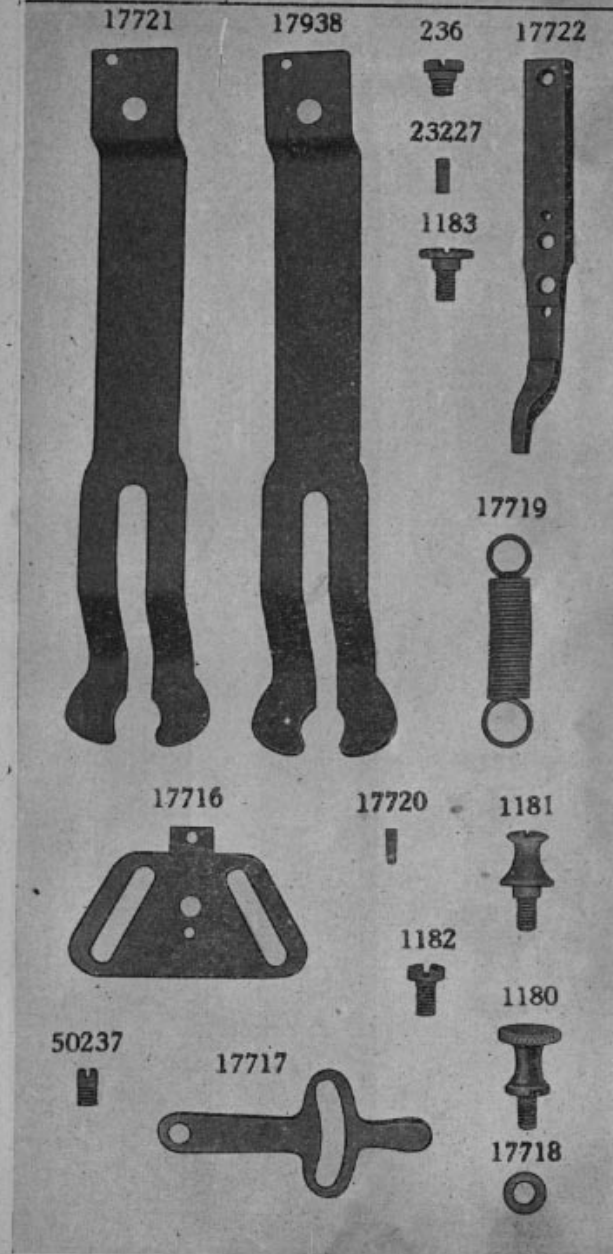

PLATE 3706—FULL SIZE

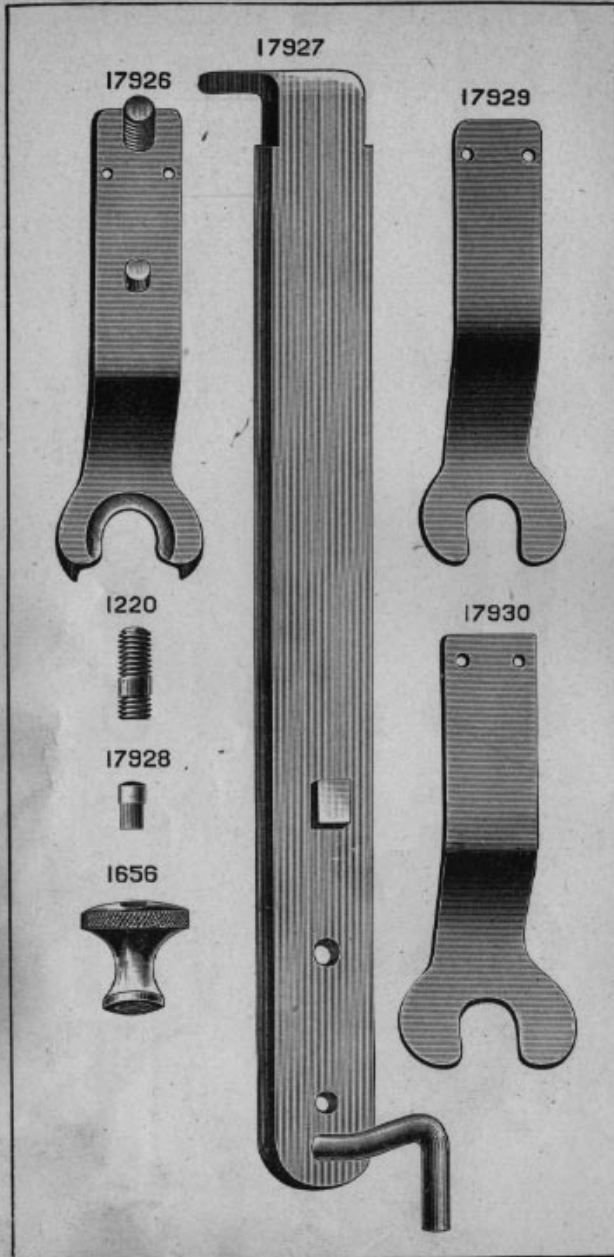

PLATE 3707—FULL SIZE

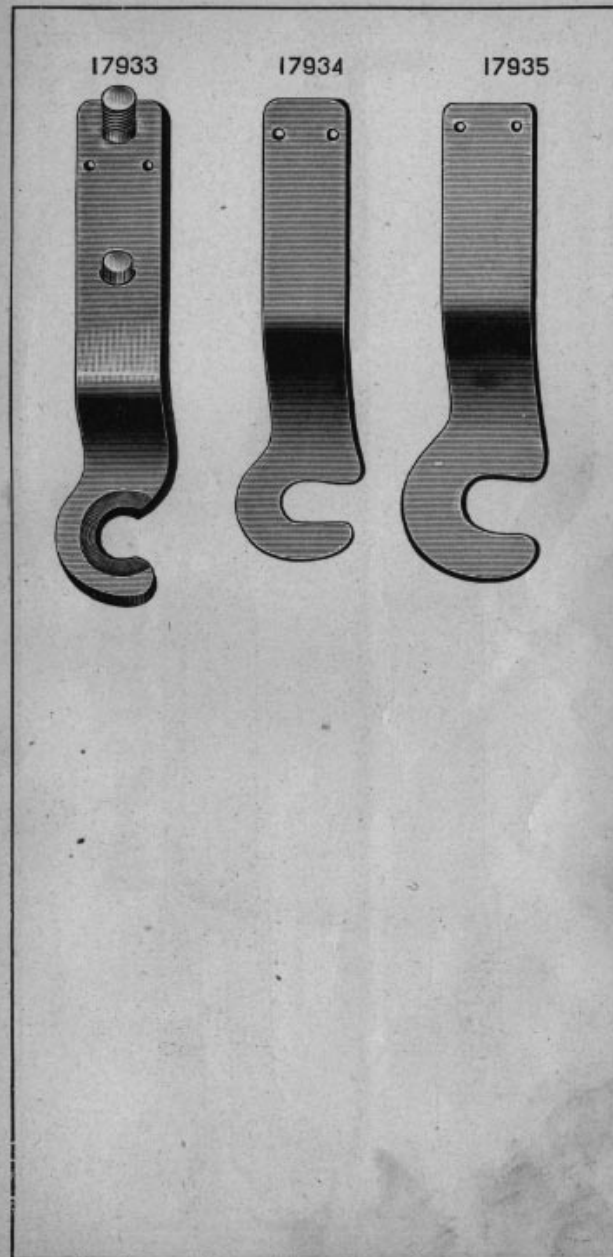

PLATE 3708—FULL SIZE

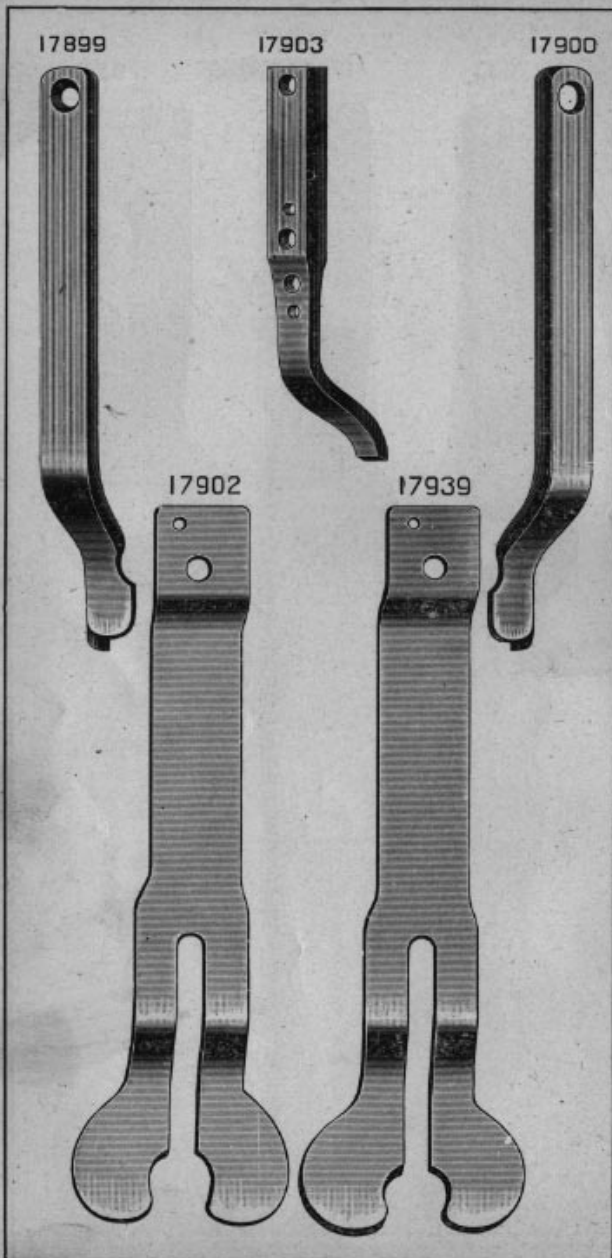

PLATE 3709—FULL SIZE

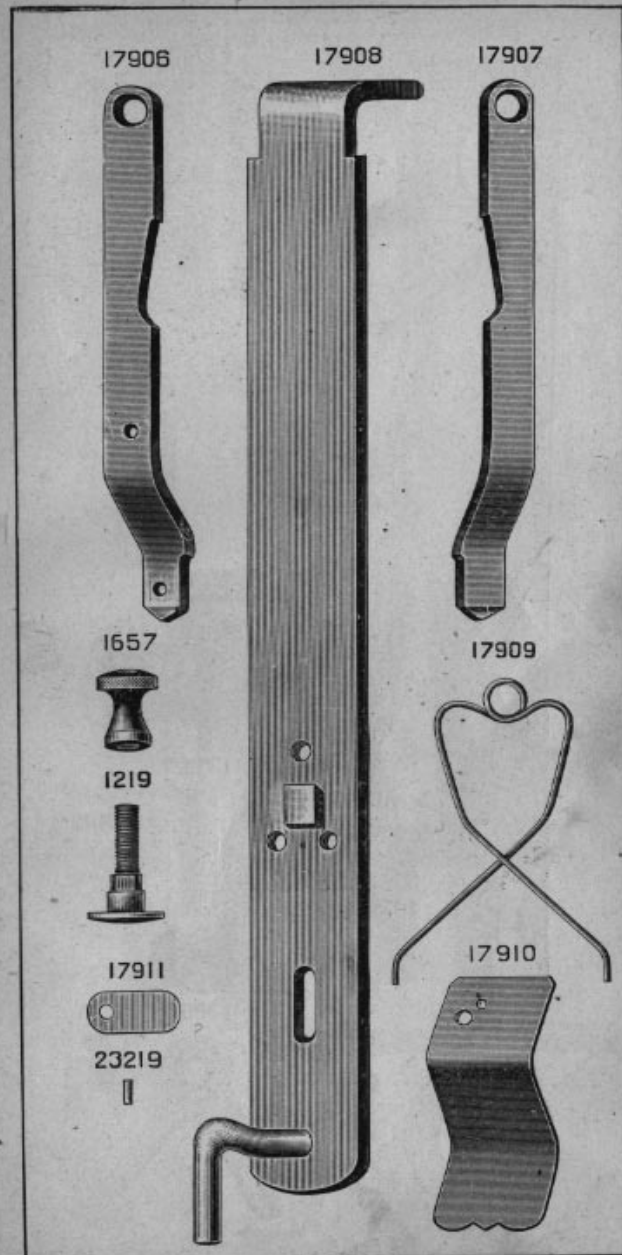

PLATE 3710—FULL SIZE

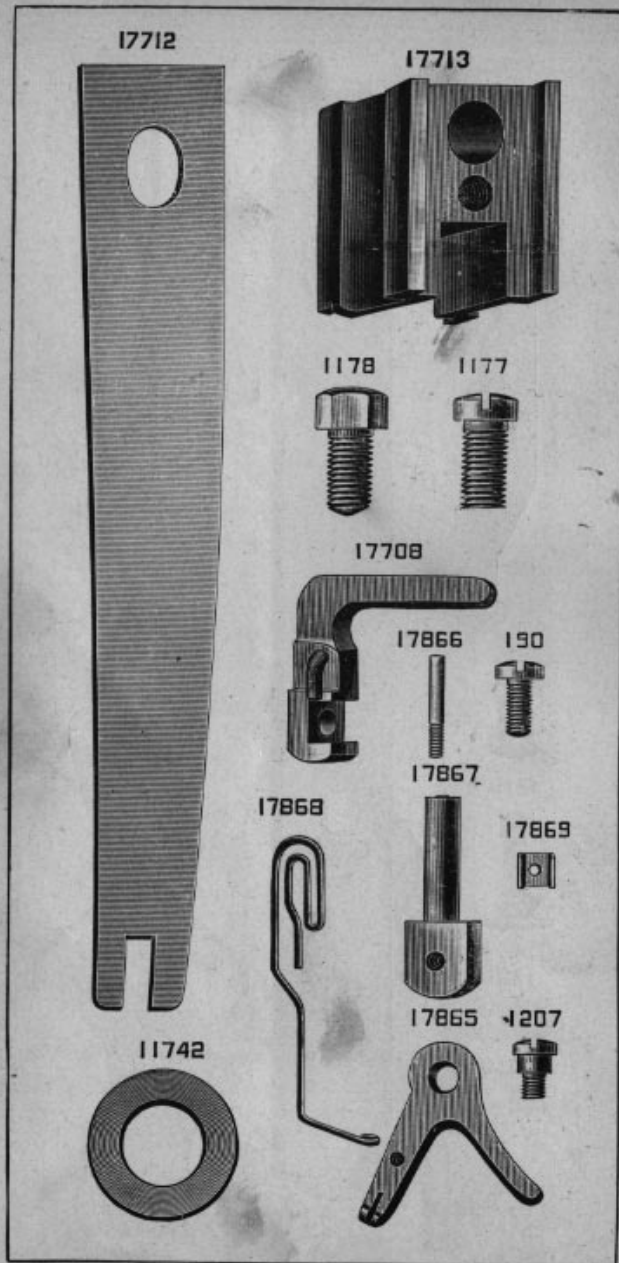

PLATE 3711—ONE-HALF SIZE

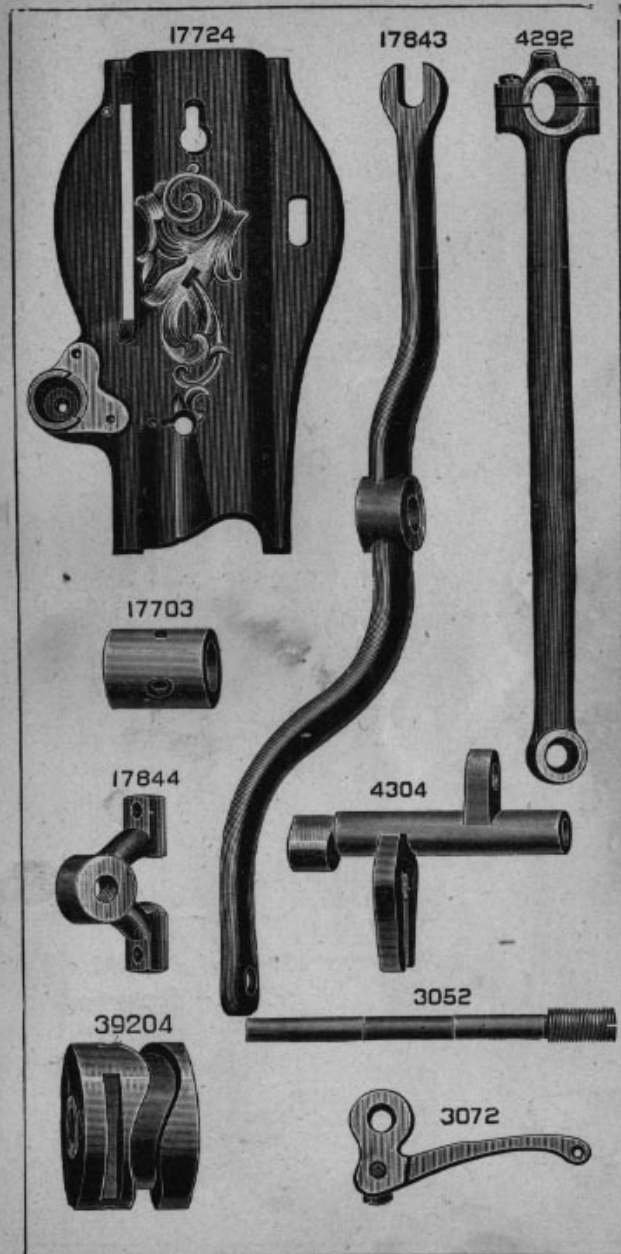

PLATE 3718—FULL SIZE

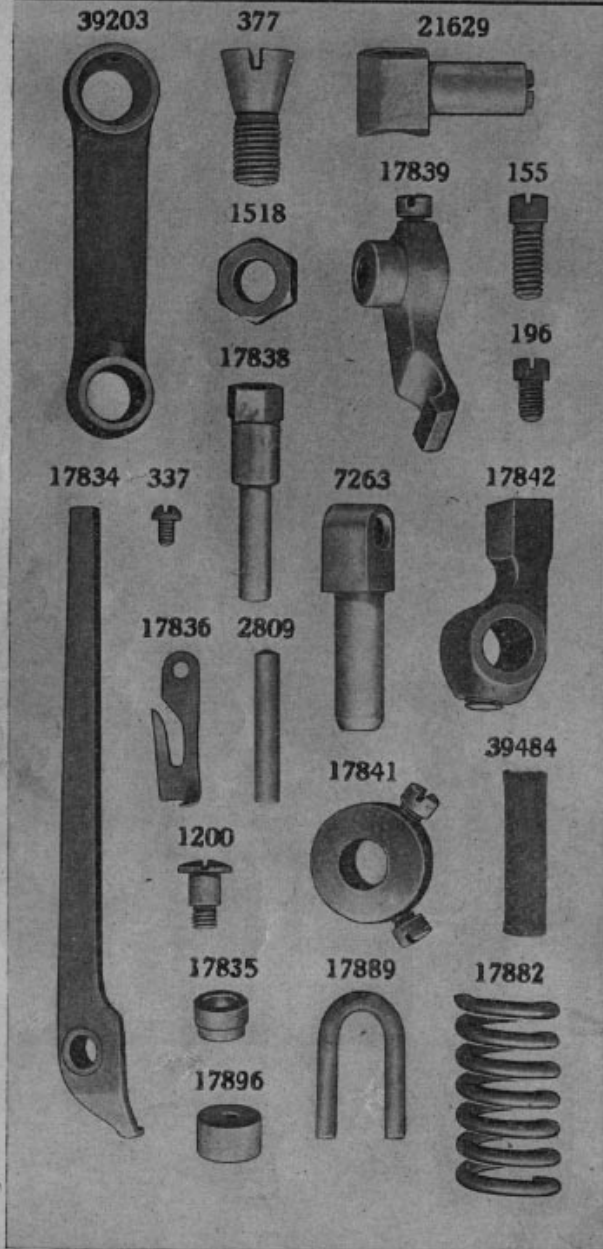

PLATE 3721—FULL SIZE

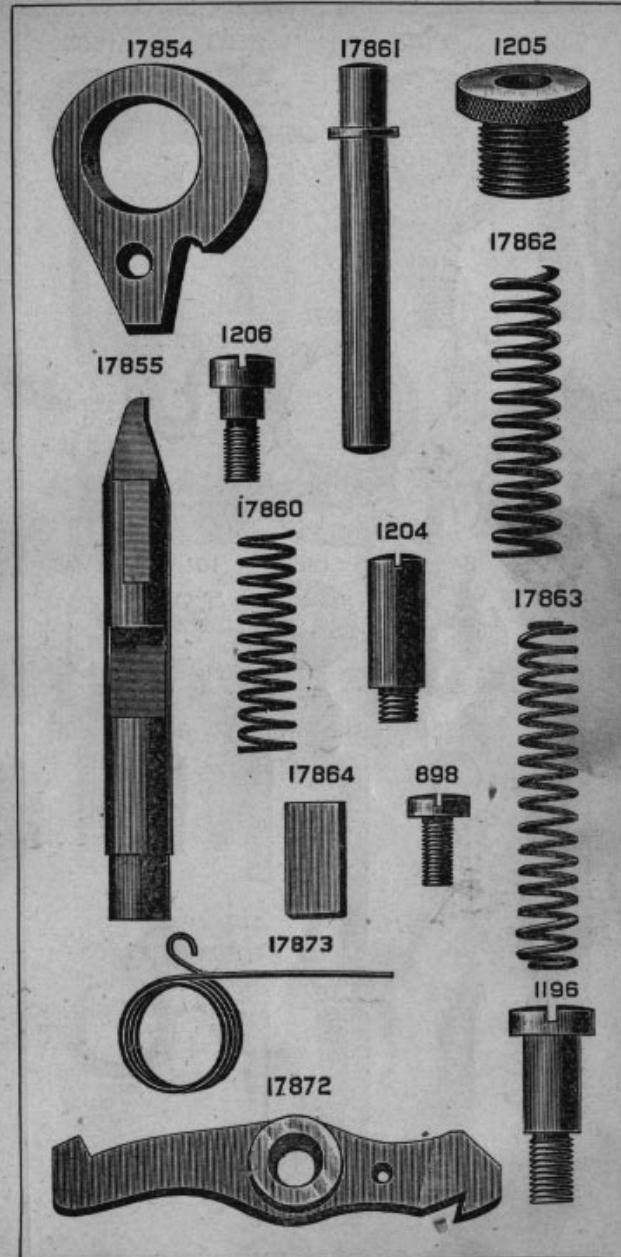

PLATE 3722—FULL SIZE

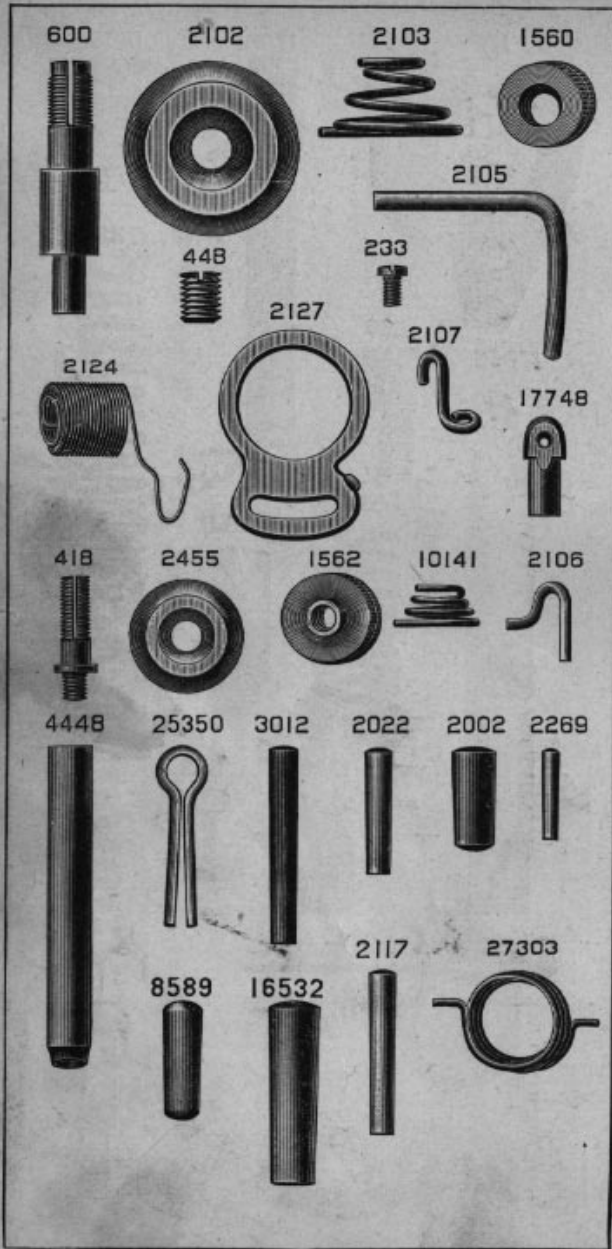

PLATE 3724—FULL SIZE

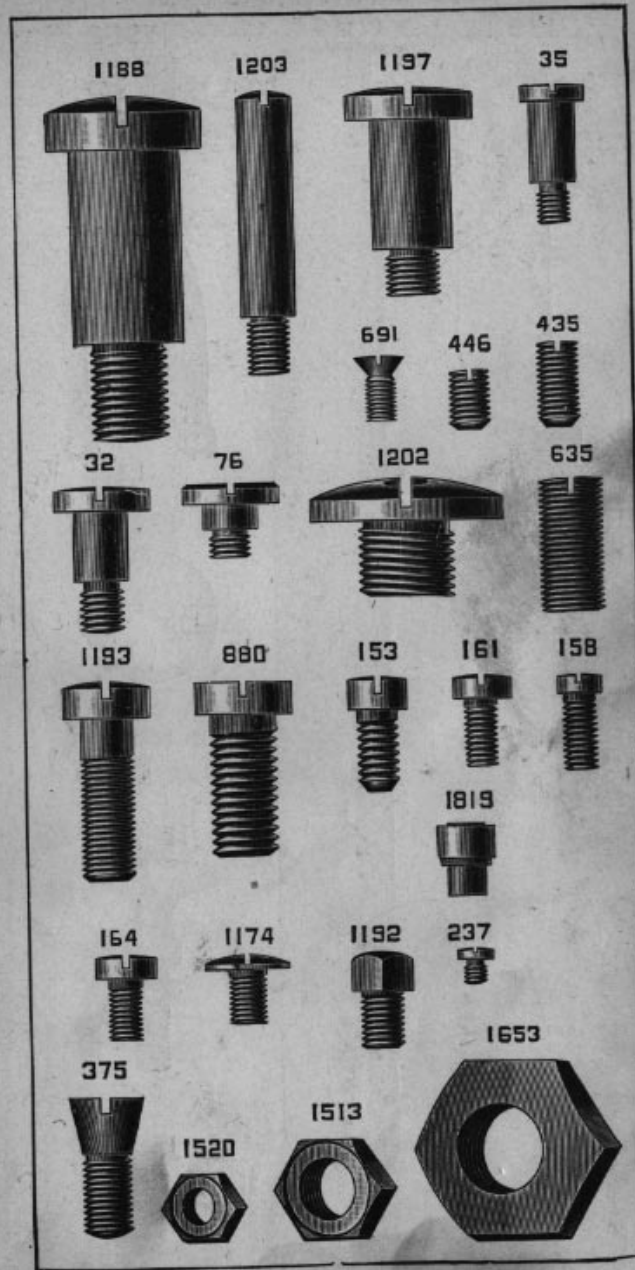

PLATE 3729—FULL SIZE

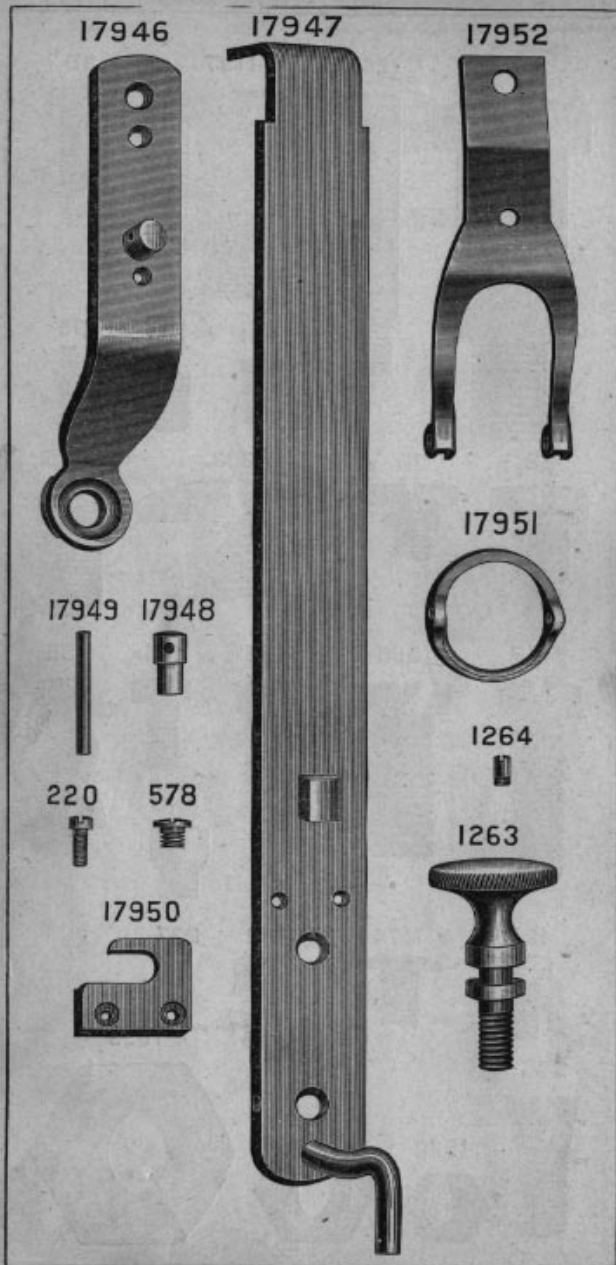
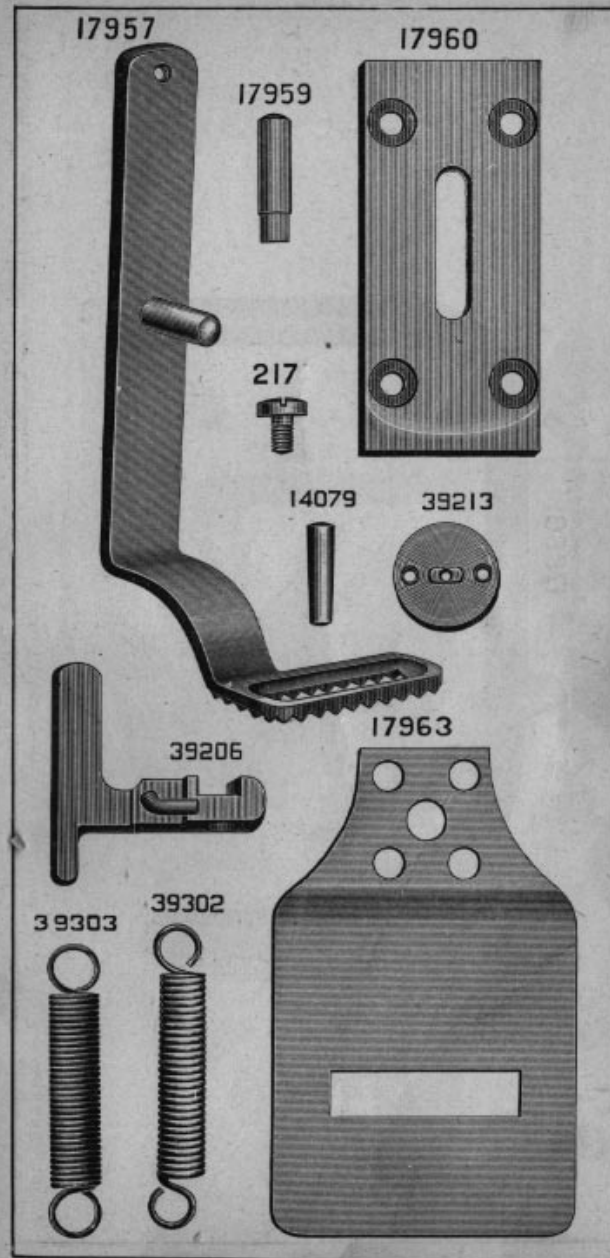

PLATE 3731—FULL SIZE



17968

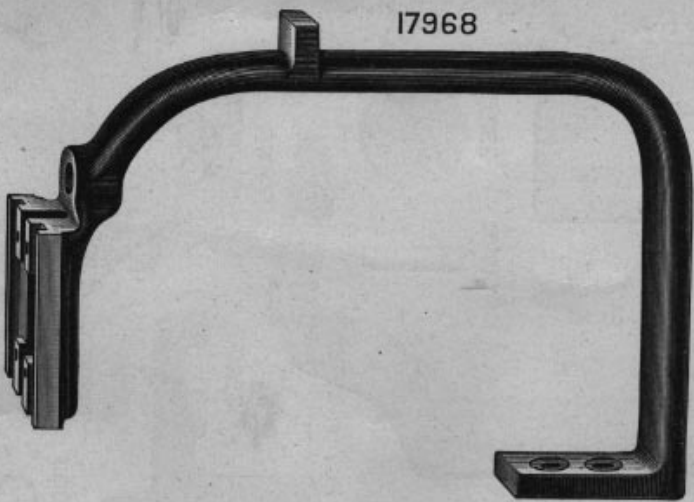

PLATE 3732—ONE-HALF SIZE

PLATE 3733—FULL SIZE

17964



17967



17965

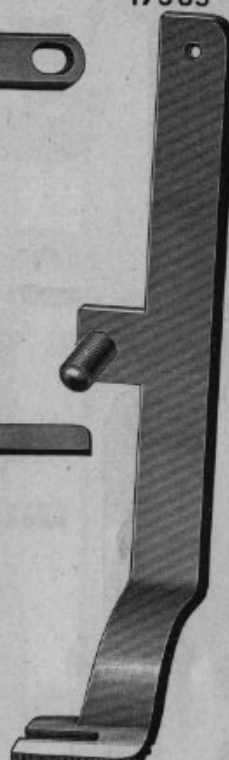

17958

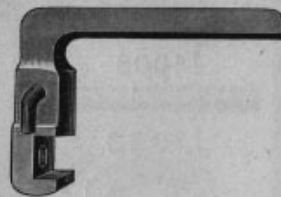

17966

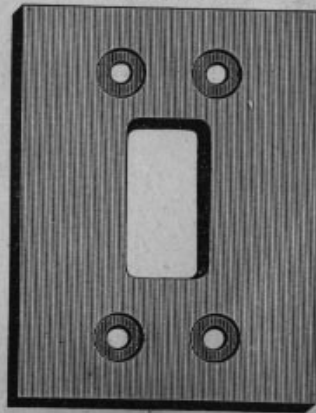

PLATE 3737—FULL SIZE

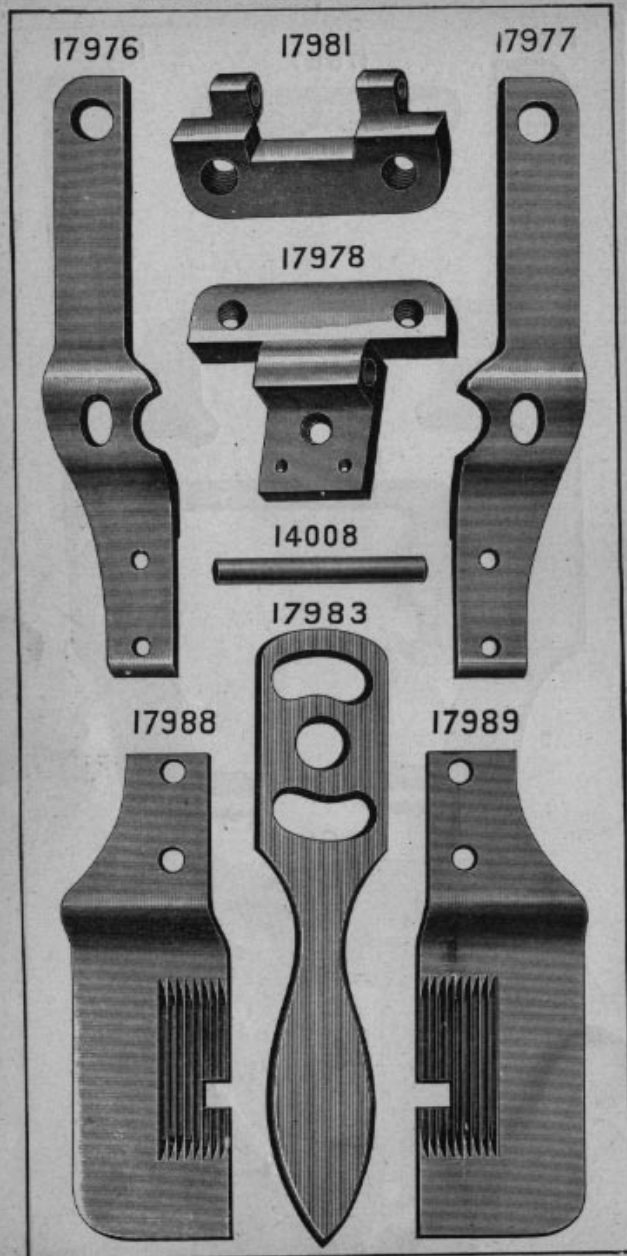

PLATE 3738—FULL SIZE

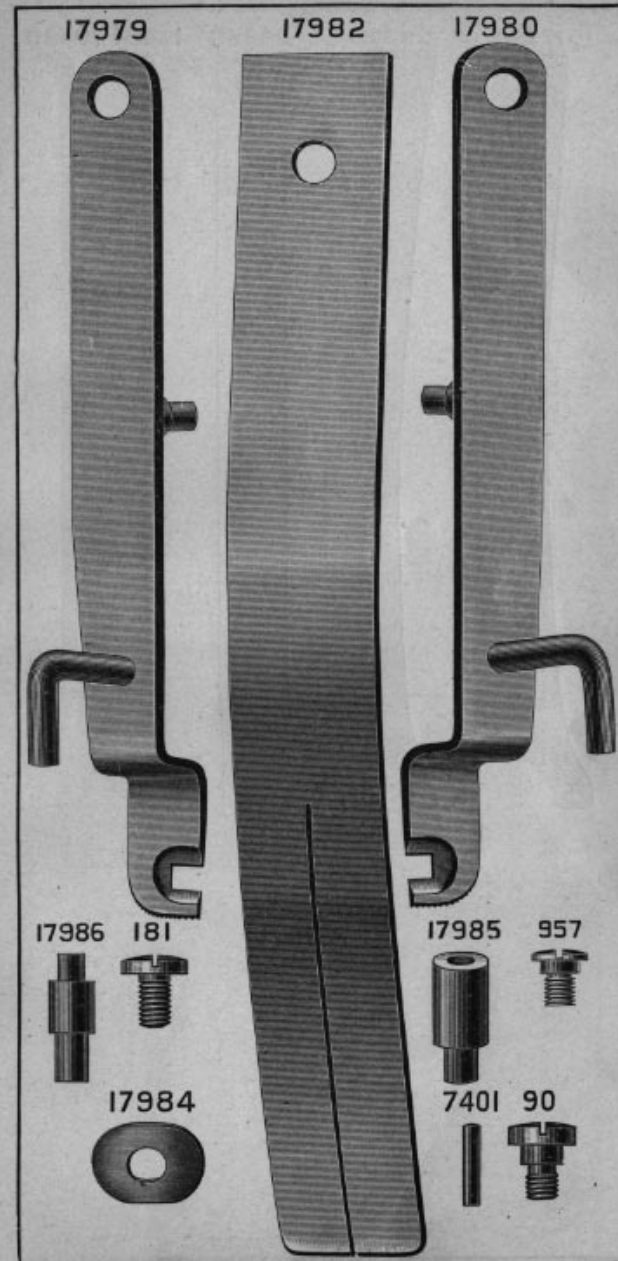

PLATE 3739—ONE-HALF SIZE

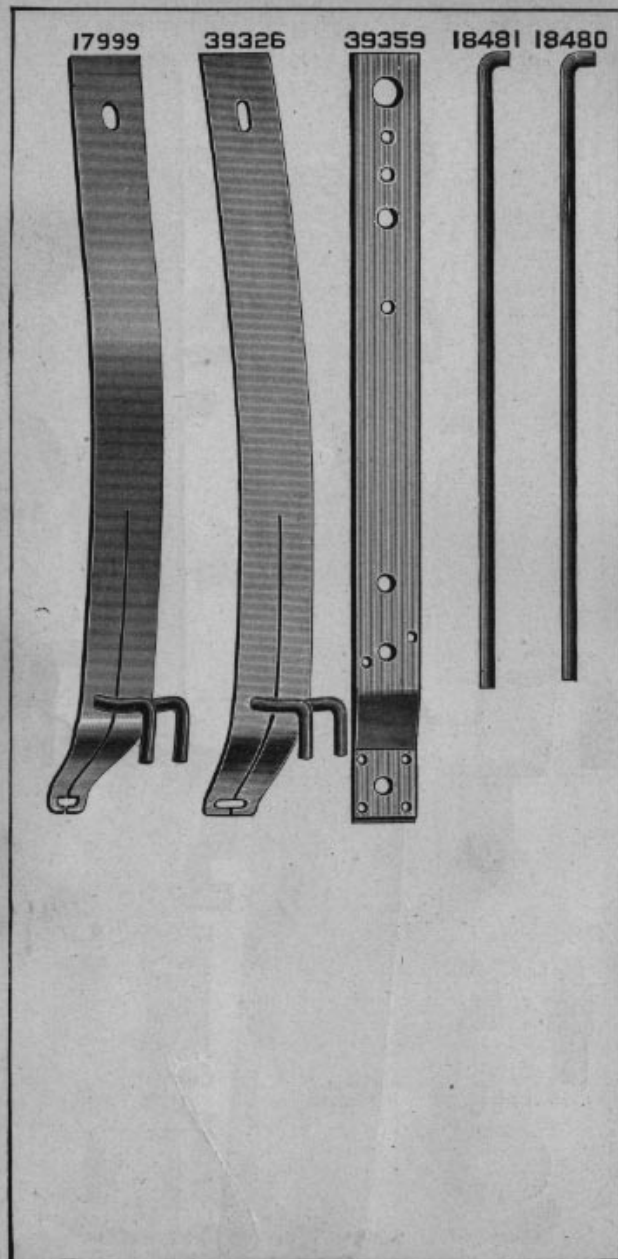

PLATE 3740—FULL SIZE

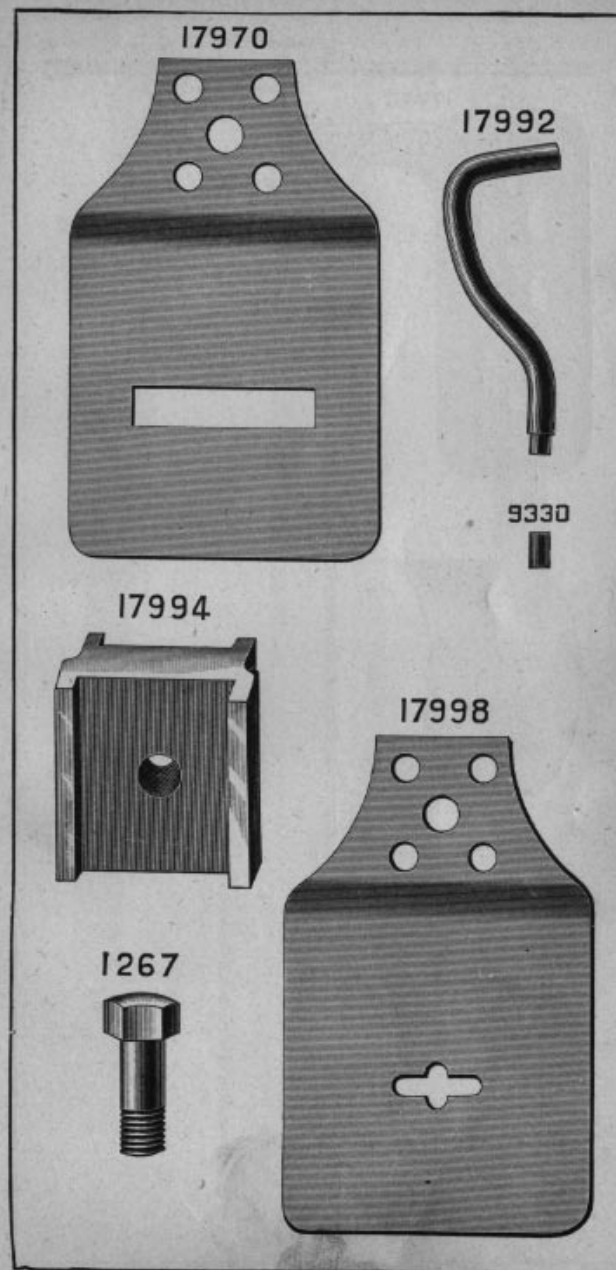

PLATE 3741—ONE-FOURTH SIZE

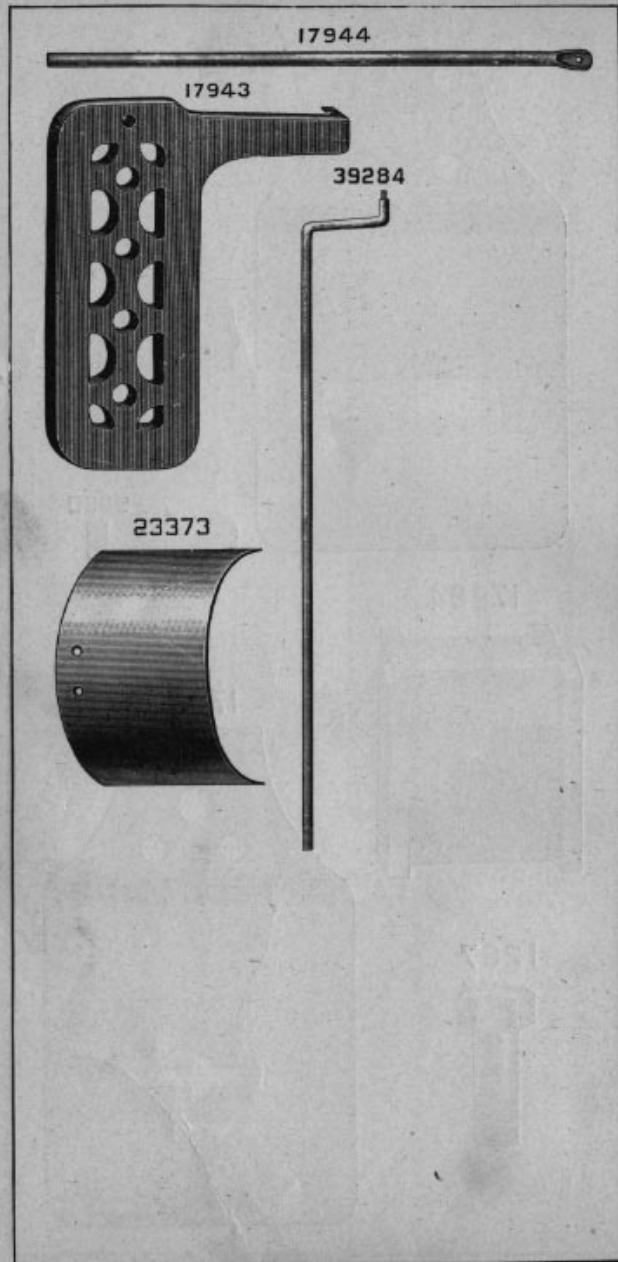

PLATE 3747—FULL SIZE

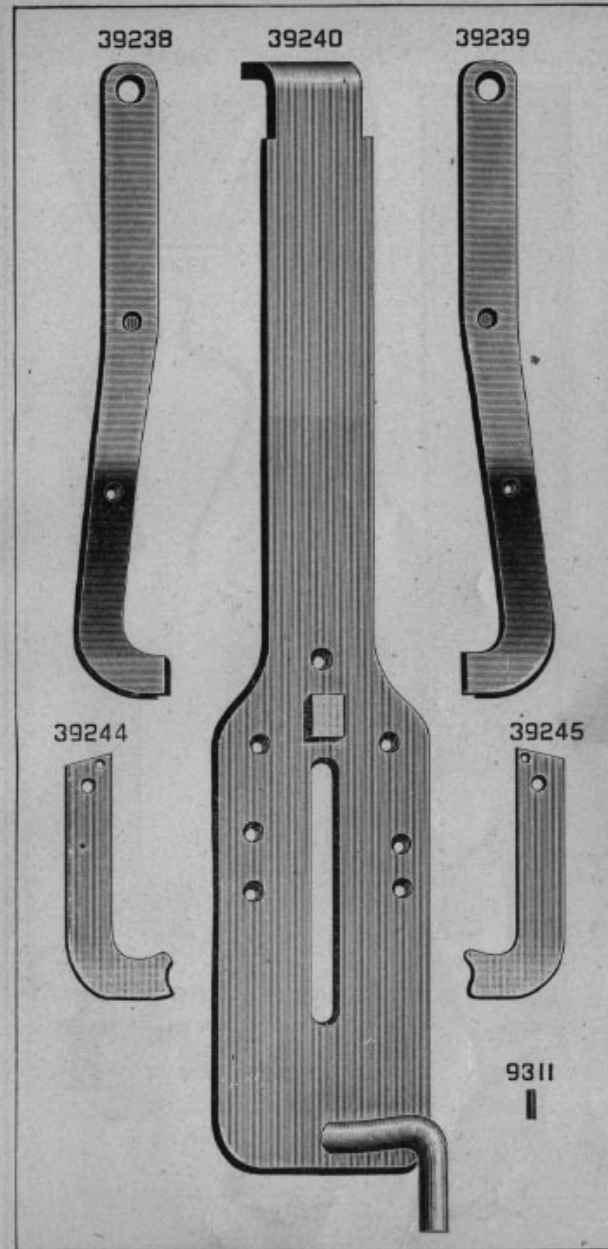
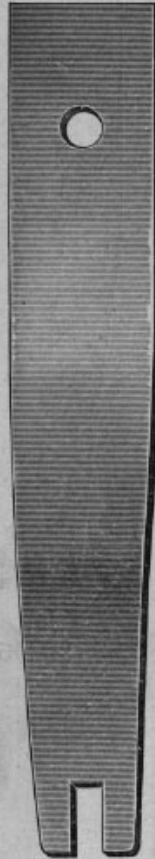

PLATE 3748—FULL SIZE

39241



39248



39242

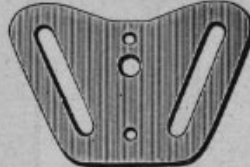

39243



39246

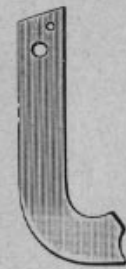

39247



690

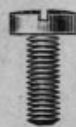

1300



168



1318



389



PLATE 3751—FULL SIZE

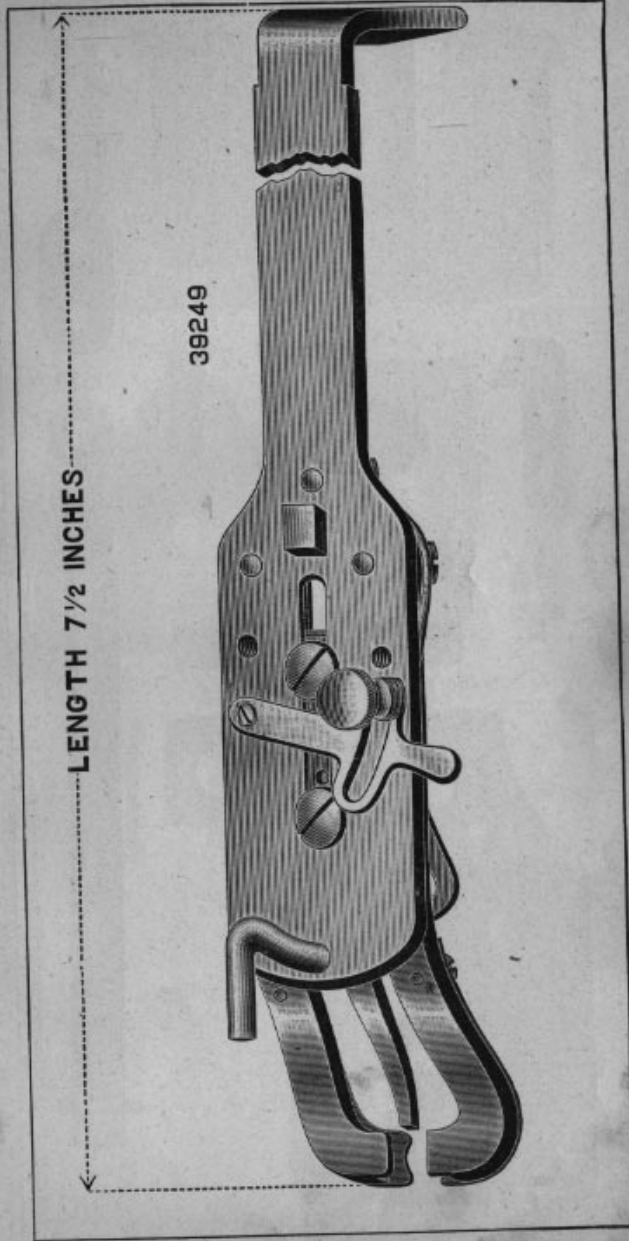

PLATE 3759—FULL SIZE

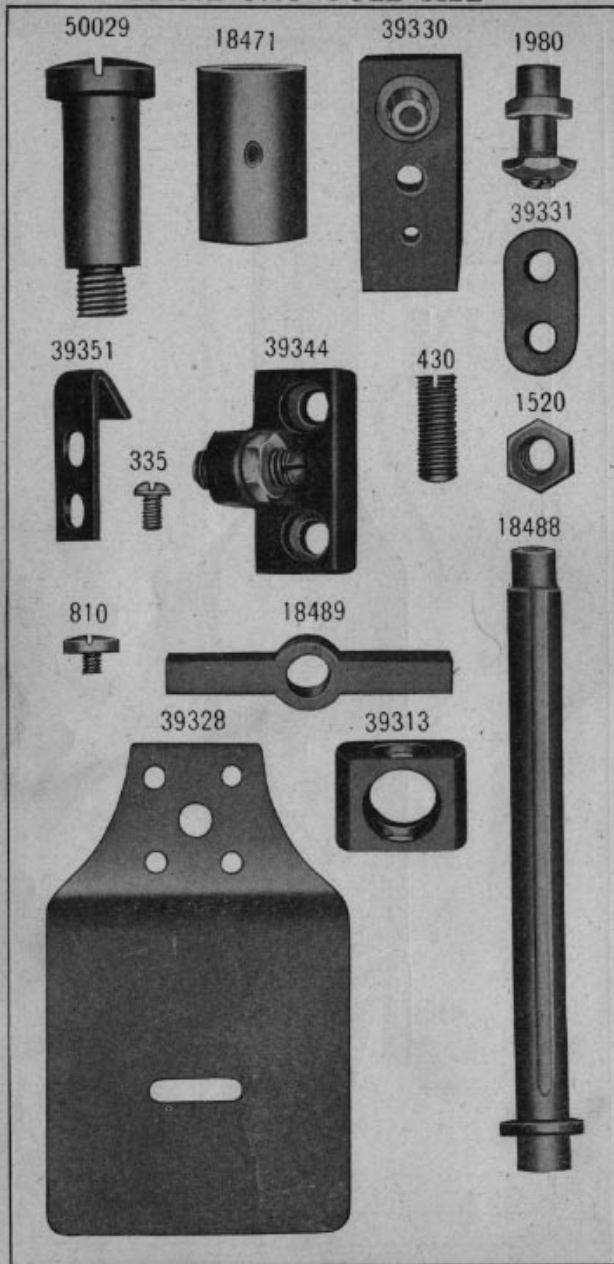

PLATE 3761—FULL SIZE

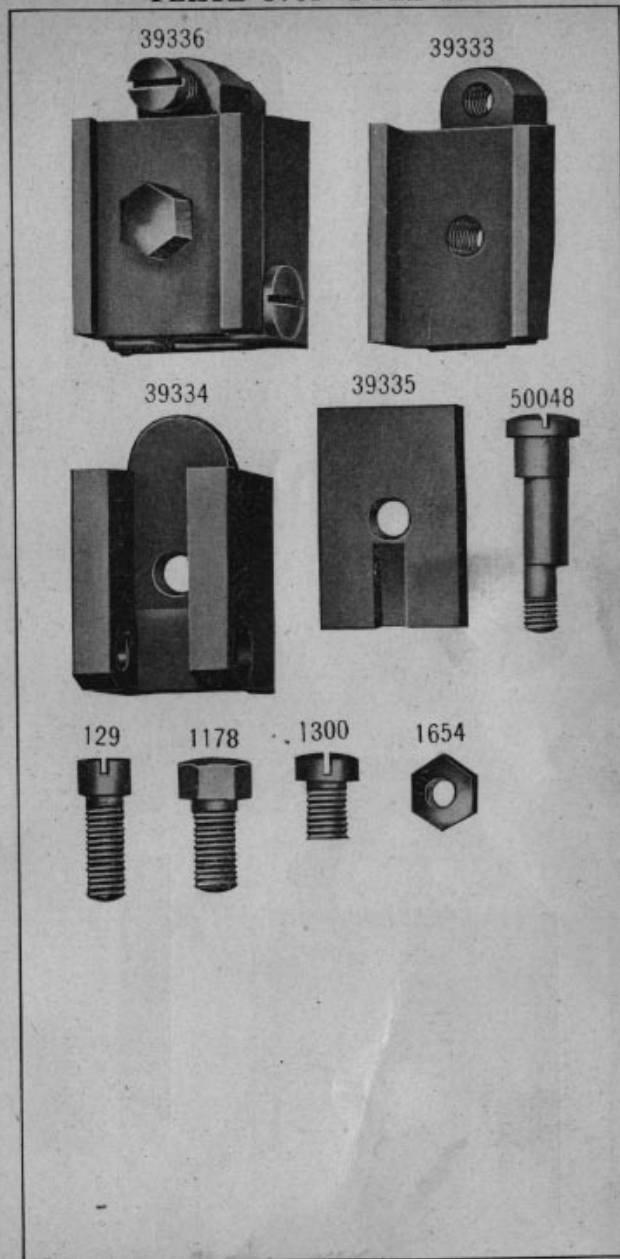

PLATE 3764—FULL SIZE

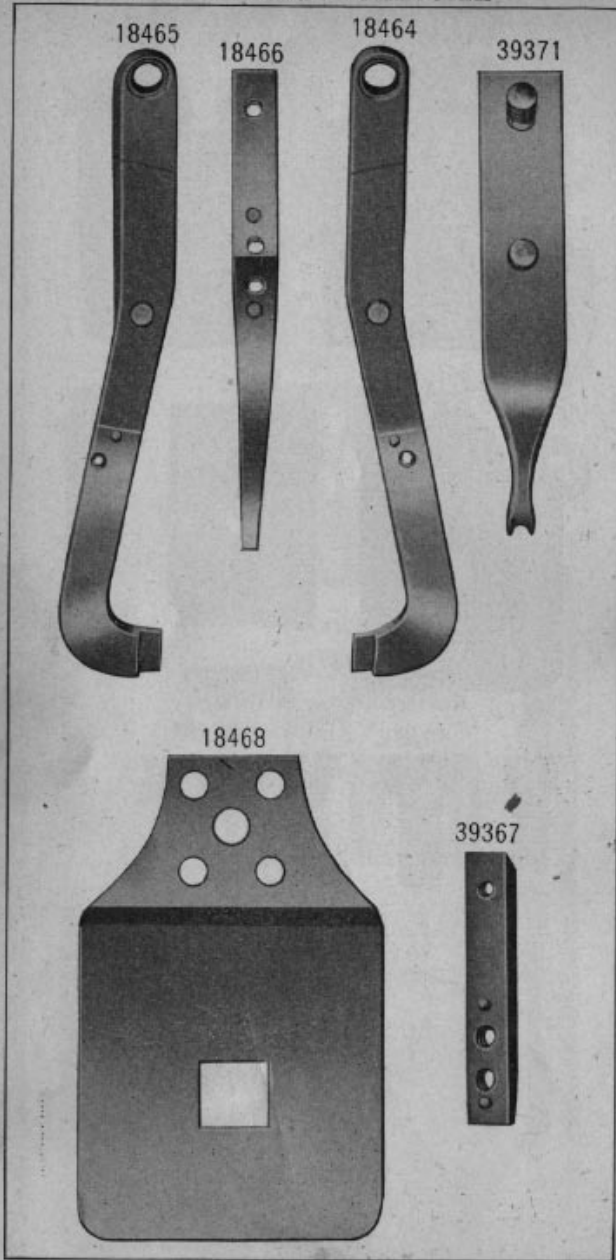

PLATE 3780—ONE-HALF SIZE

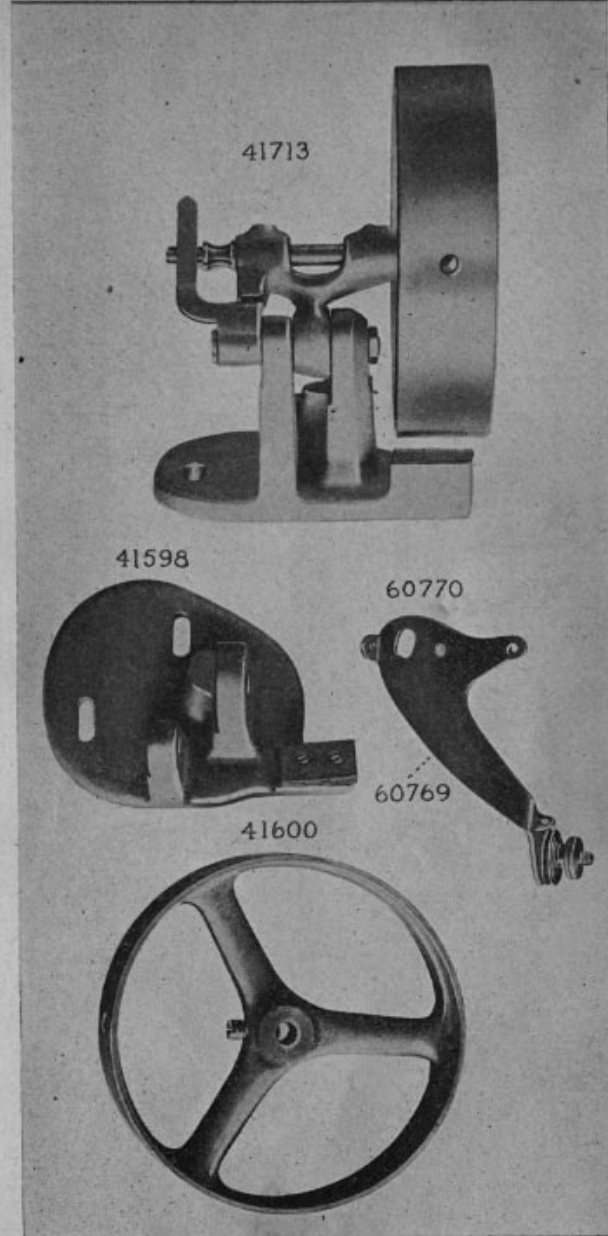

PLATE 3781—FULL SIZE

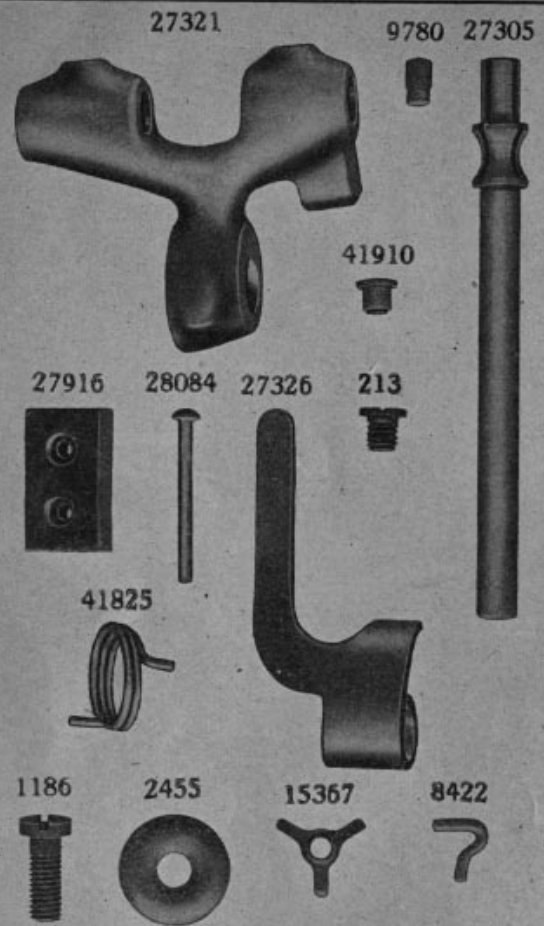

PLATE 4079—ONE-HALF SIZE

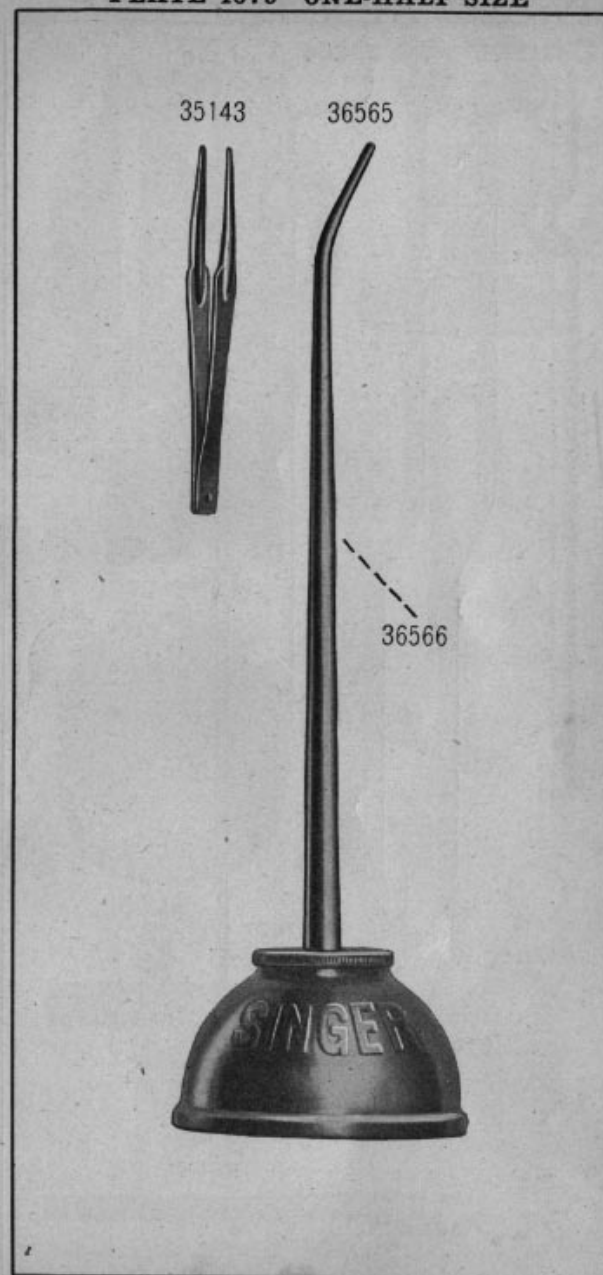

PLATE 5000—ONE-FOURTH SIZE

17702 18370 18426 39254 17880

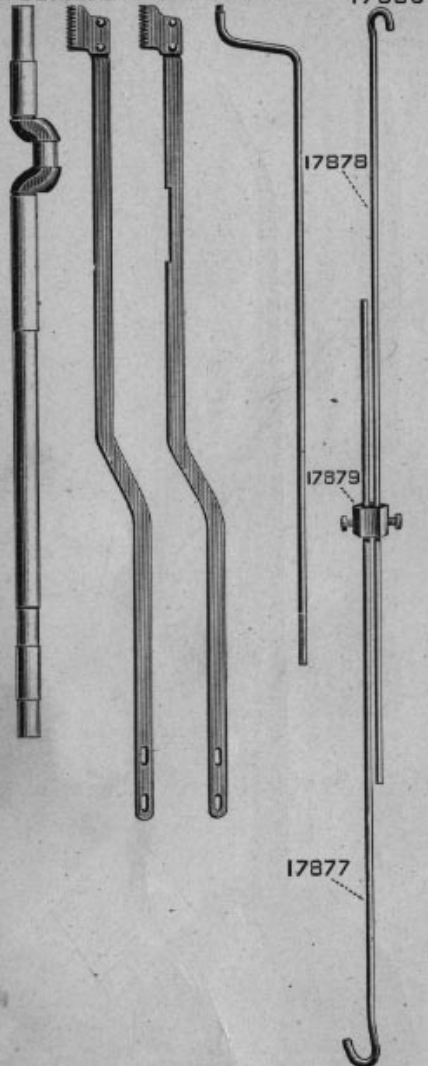
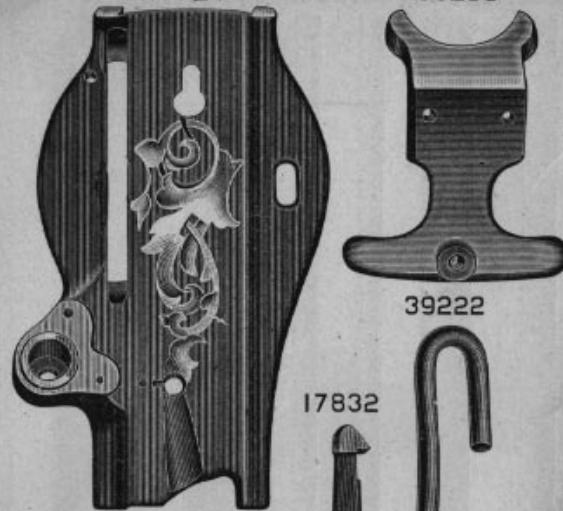

PLATE 5001—ONE-HALF SIZE

17724

39290



39222

17832

18427



17833

17840



8414

6022

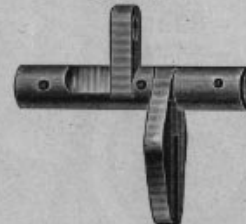

17703



6489



PLATE 5002—ONE-HALF SIZE

16385 18358 17831 2058 18445 4292

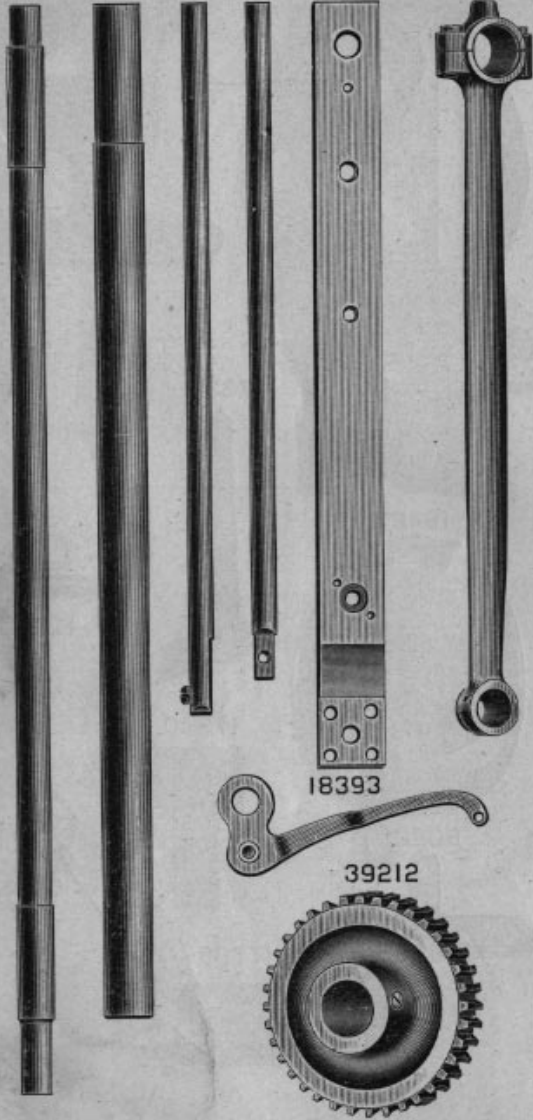

PLATE 5003—ONE-HALF SIZE

17942 17848 17941

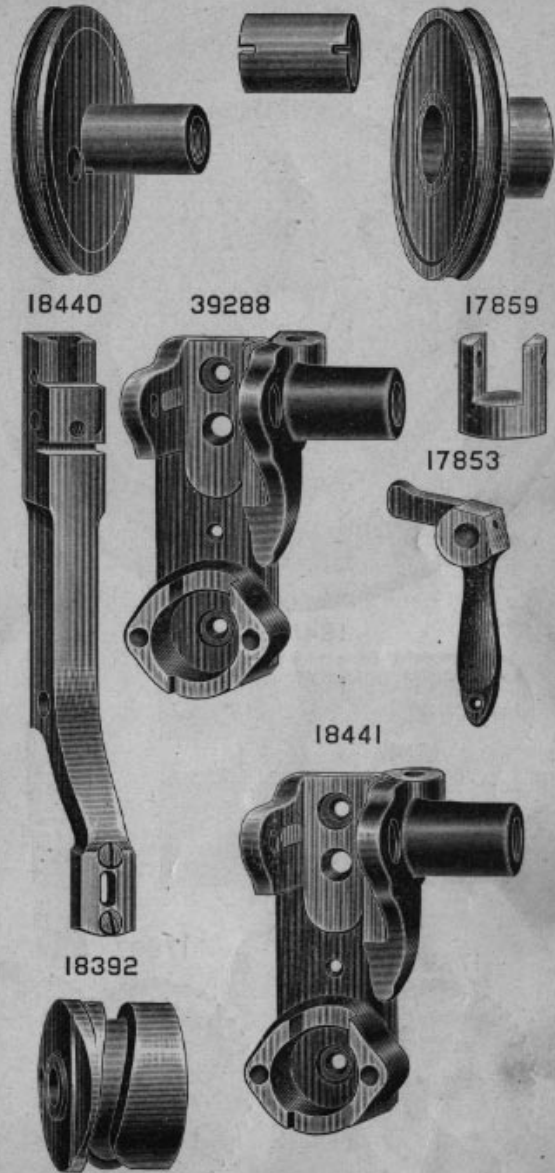

PLATE 5004—ONE-HALF SIZE

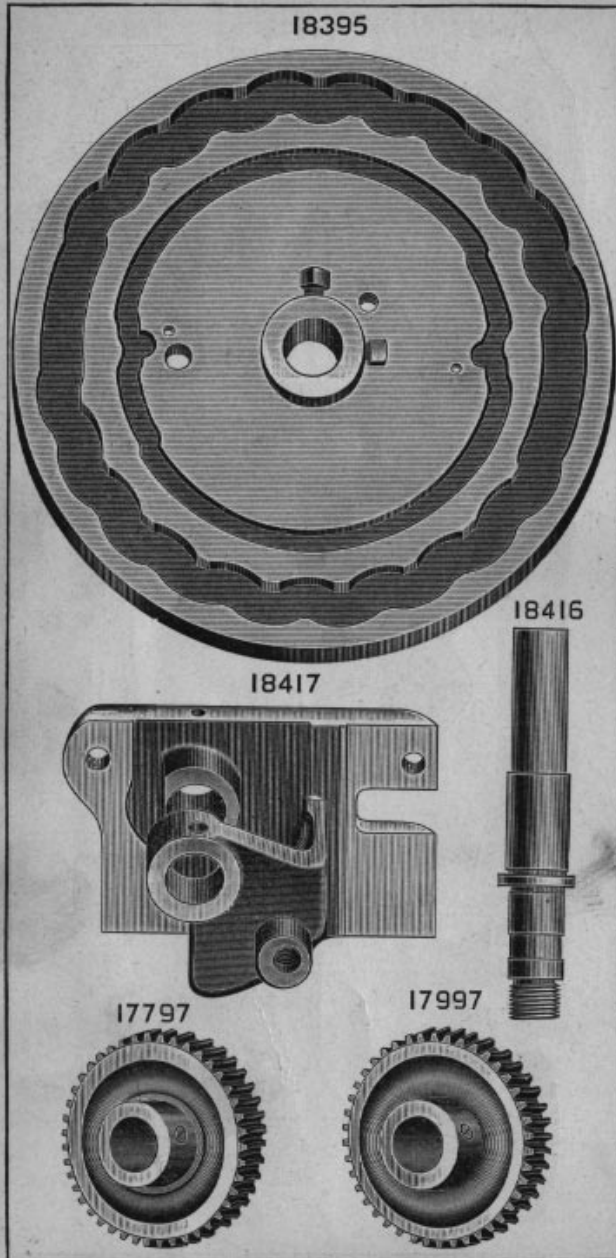

PLATE 5005—FULL SIZE

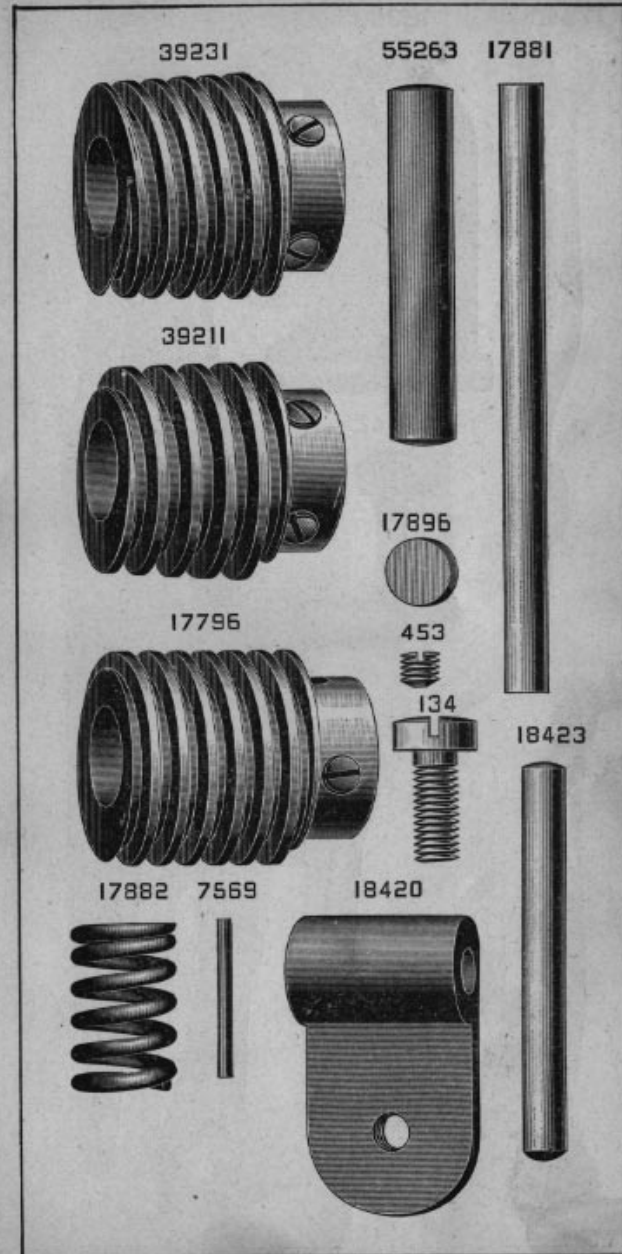

PLATE 5006—ONE-HALF SIZE

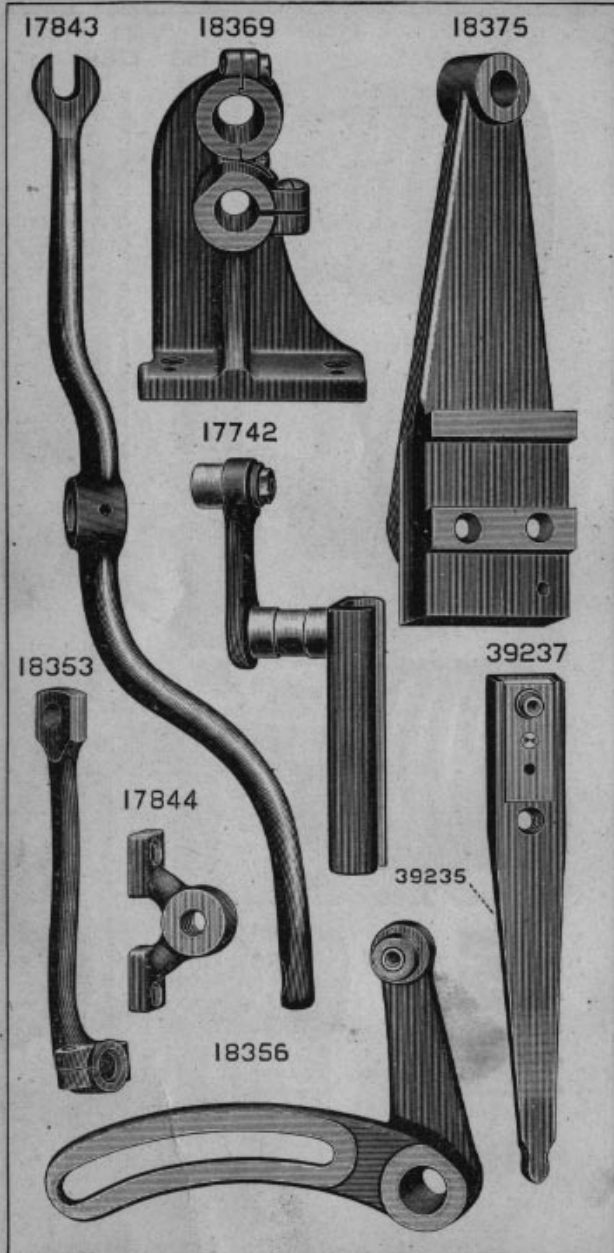

PLATE 5007—FULL SIZE

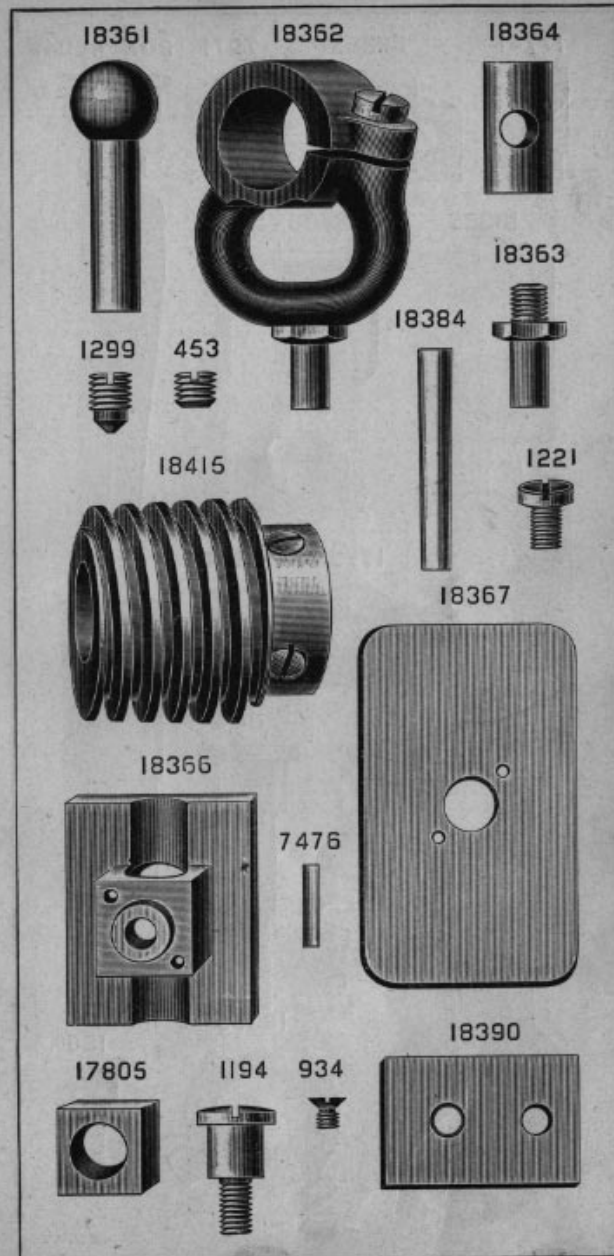

PLATE 5008—FULL SIZE

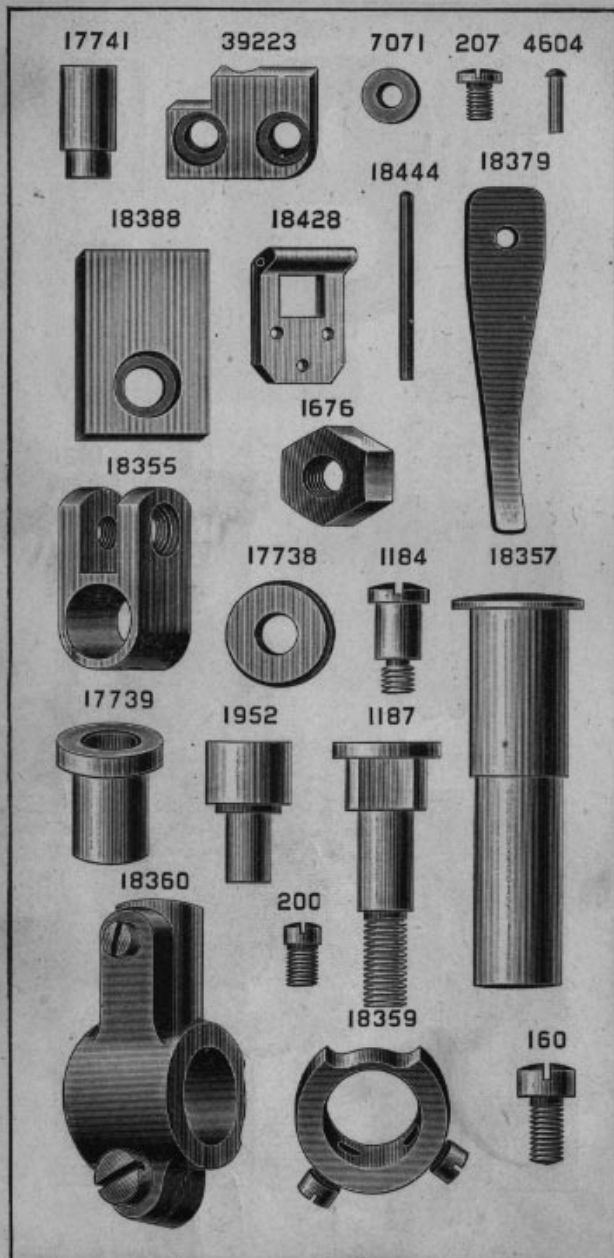
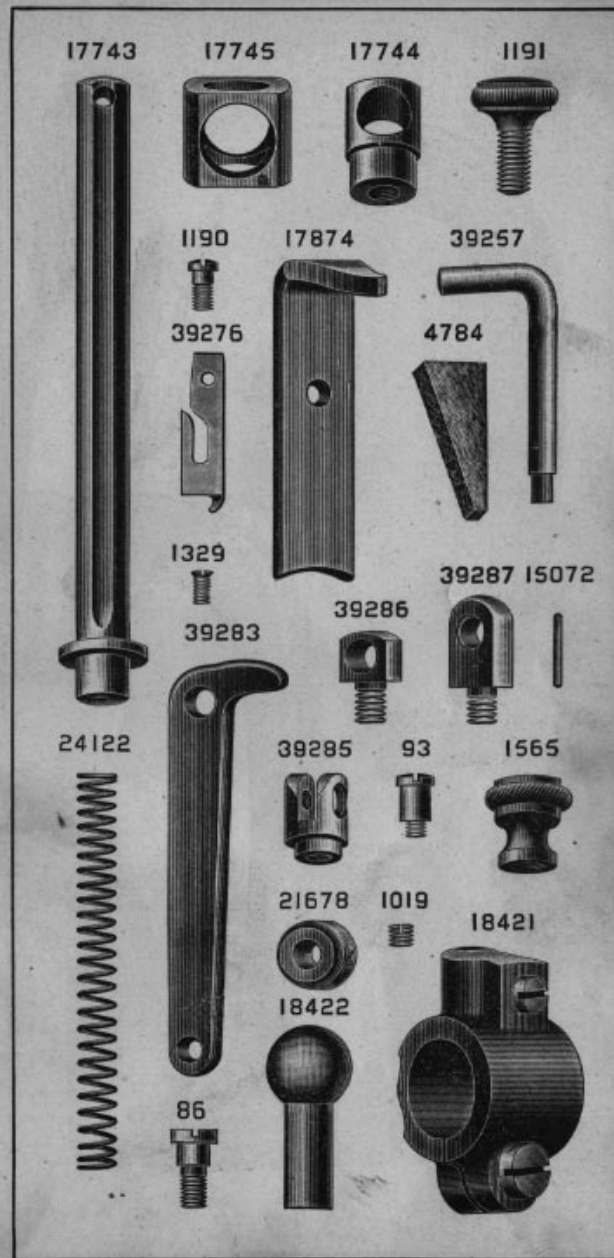

PLATE 5009—FULL SIZE



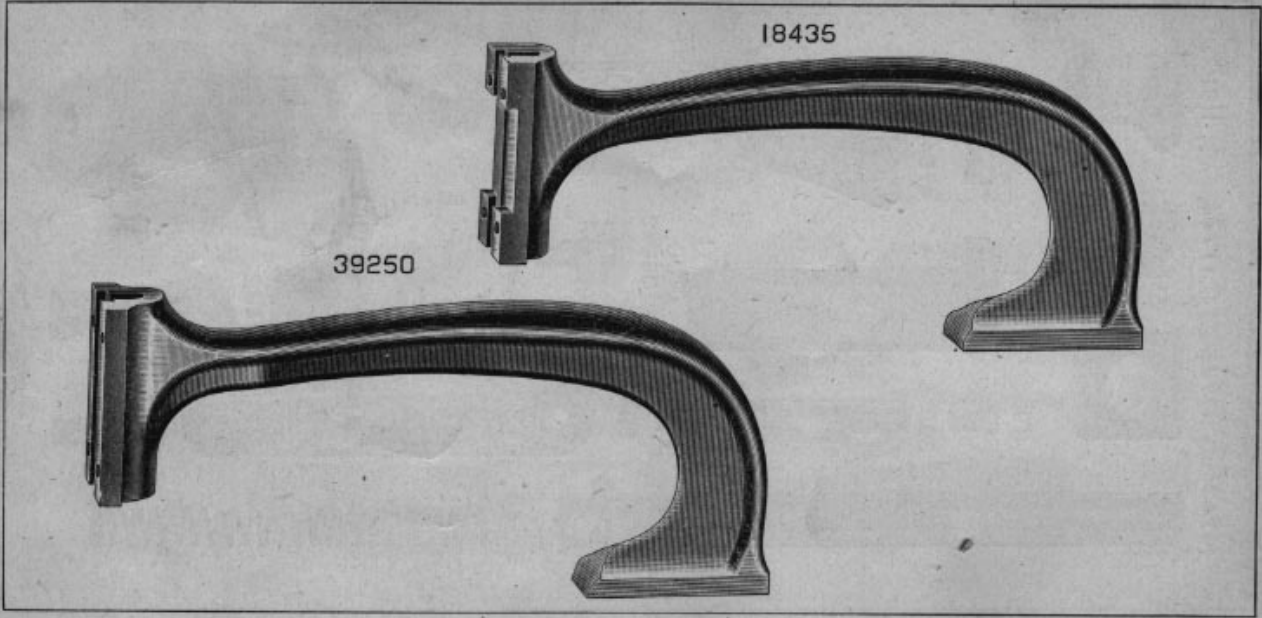

PLATE 5010—ONE-HALF SIZE

PLATE 5011—FULL SIZE

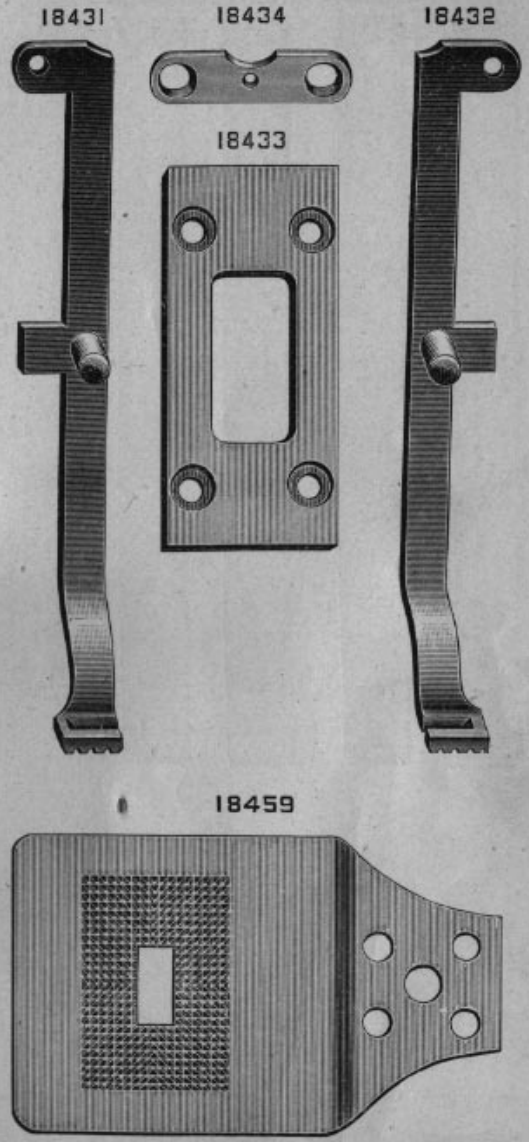

PLATE 5012—ONE-HALF SIZE

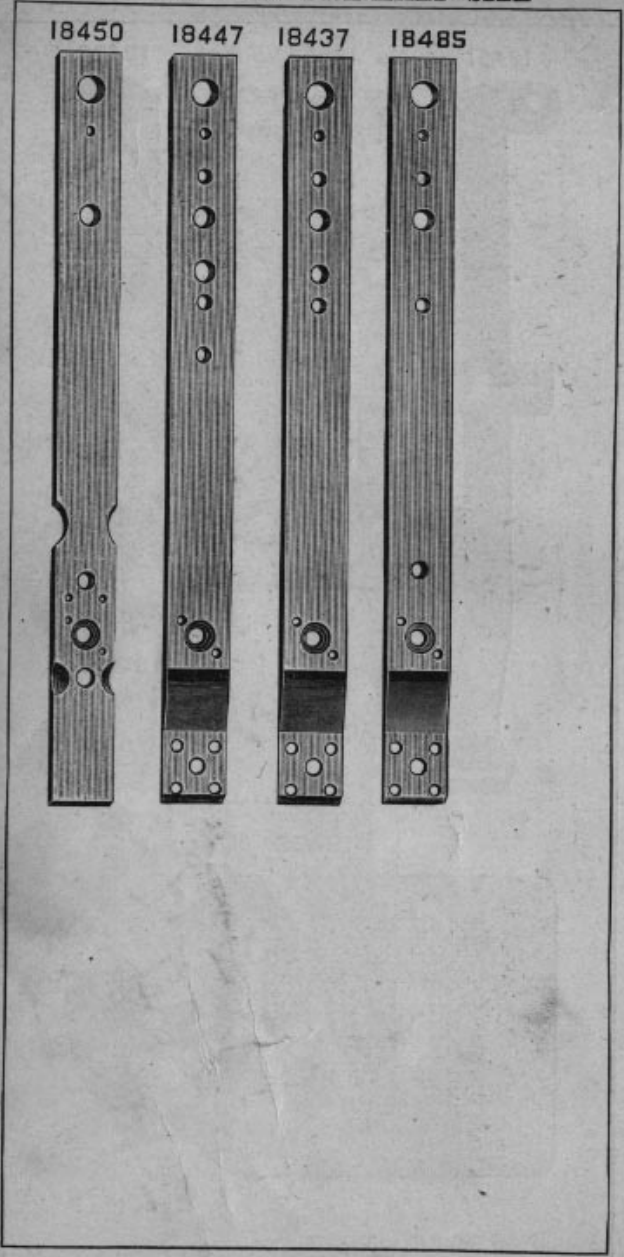

PLATE 5013—FULL SIZE

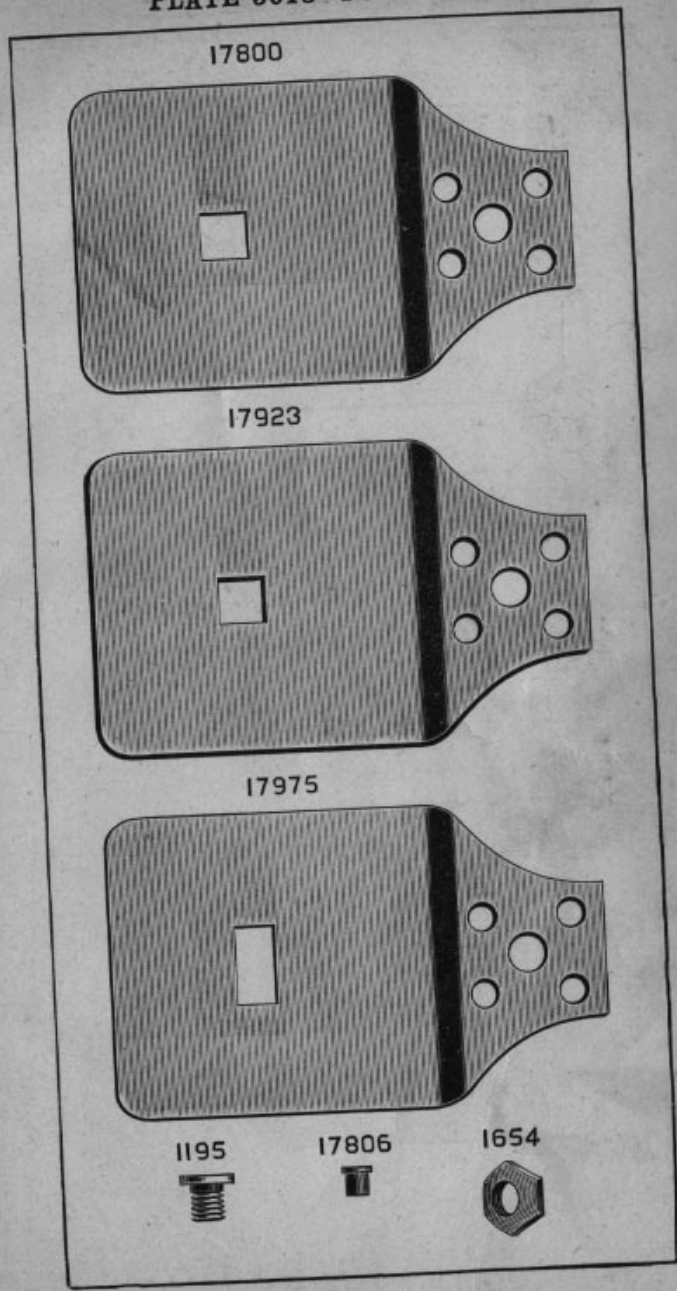
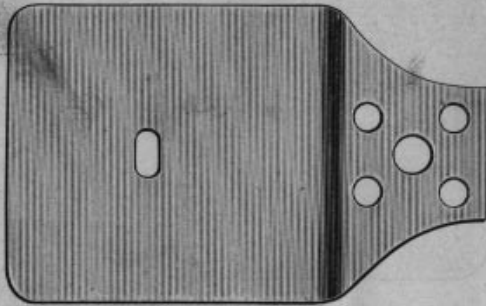
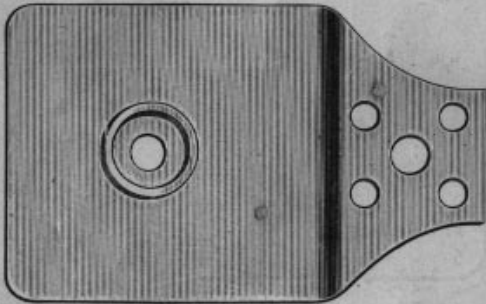

PLATE 5014—FULL SIZE

39258



17954



39304

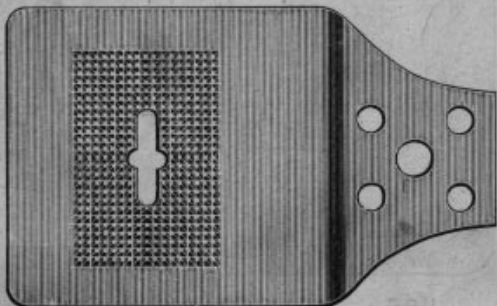

PLATE 5015—FULL SIZE

17808



18389



17829

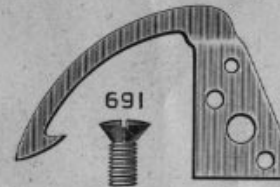

7298



1198



17830



691



17825



17828

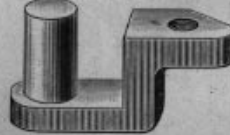

17827



39236



18373

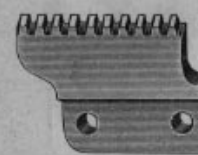

17826



1964



5944



17822



18443



18371

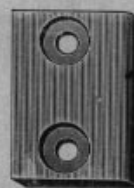

193



14017



19793



PLATE 5016—FULL SIZE

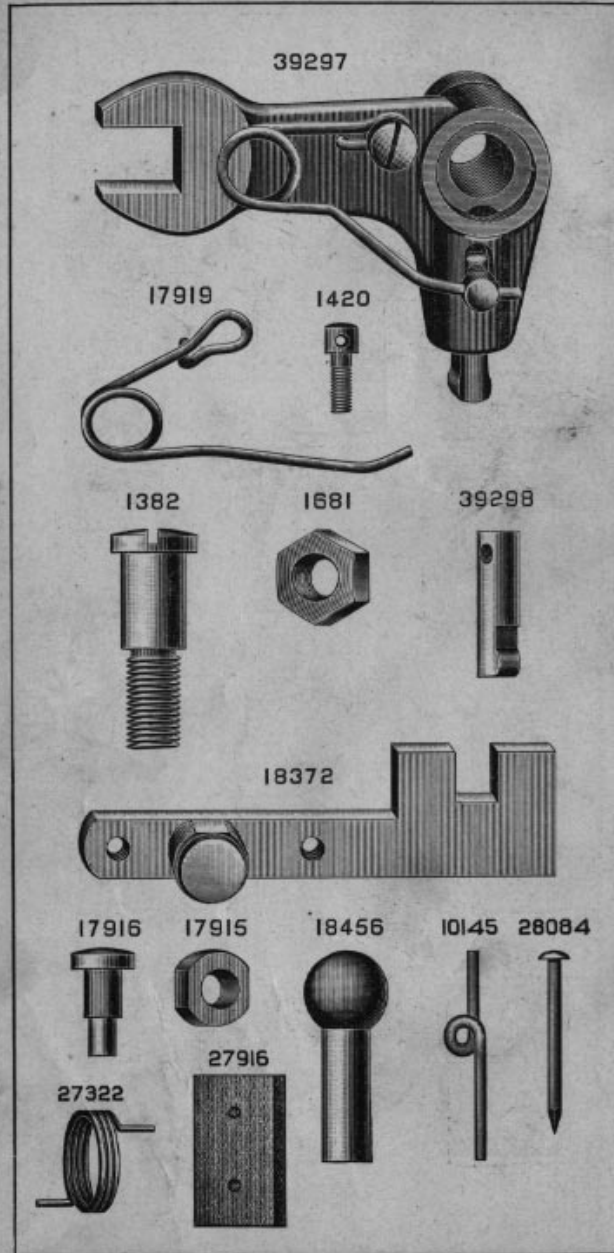

PLATE 5017—FULL SIZE

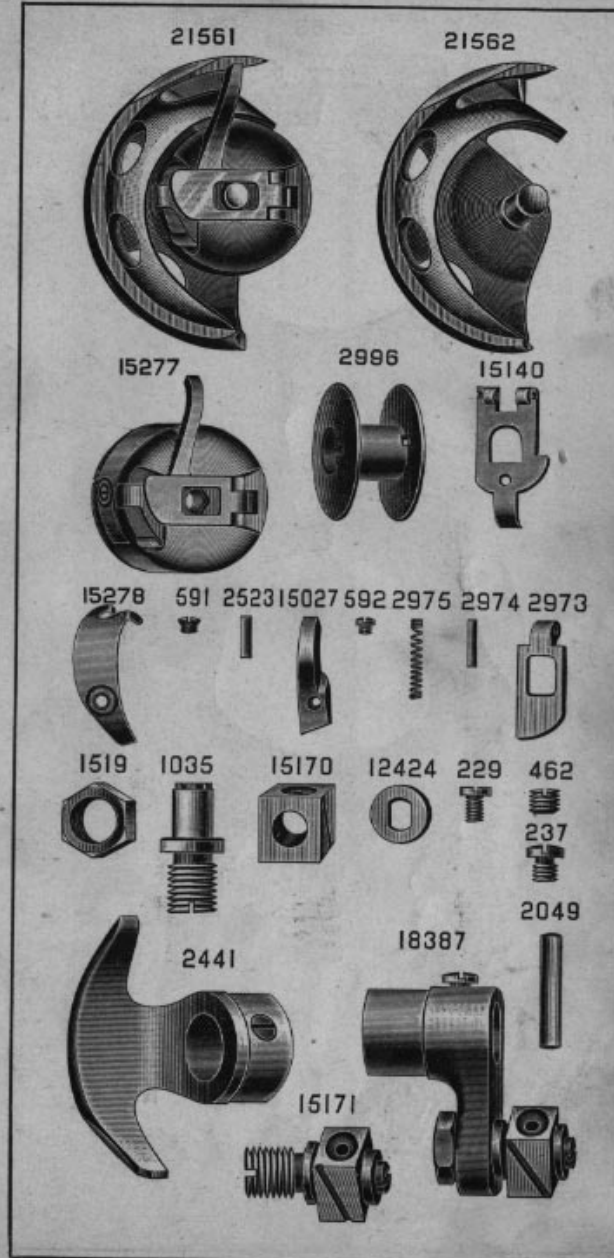

PLATE 5018—FULL SIZE

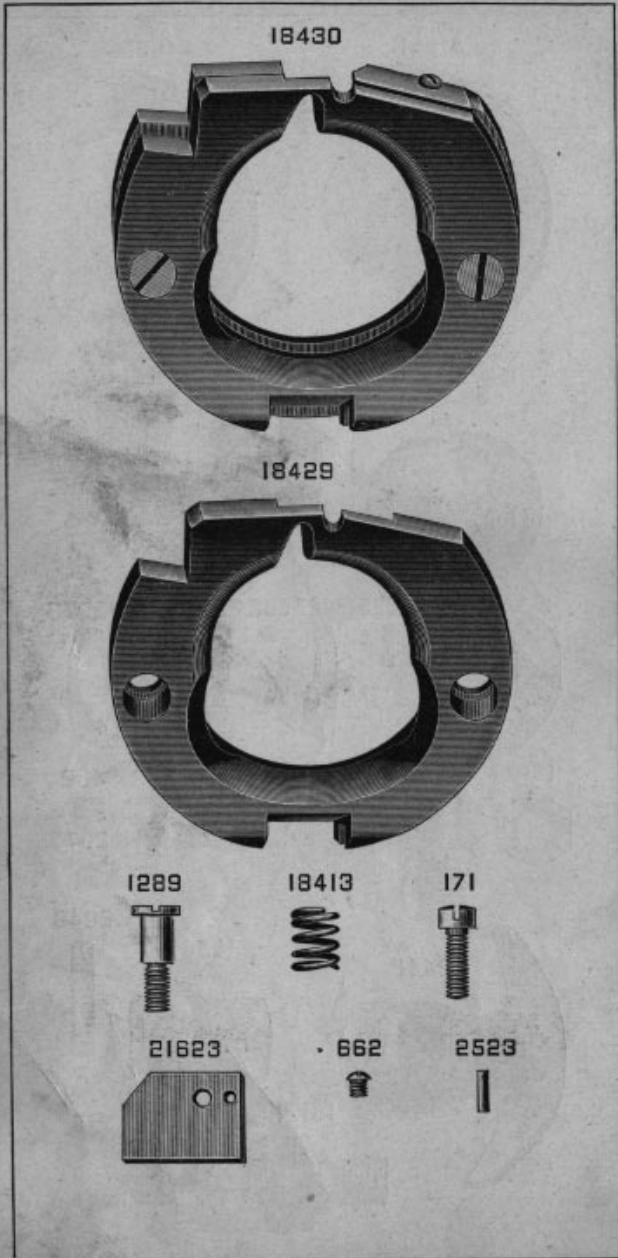

PLATE 5019—ONE-HALF SIZE

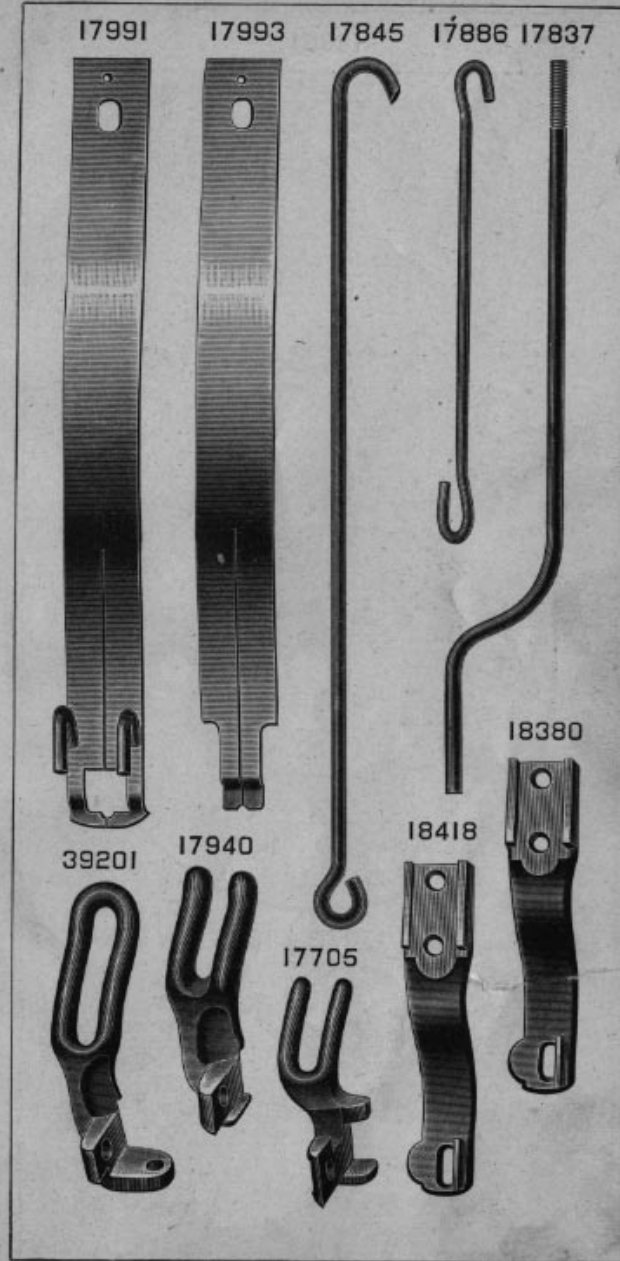

PLATE 5020—FULL SIZE

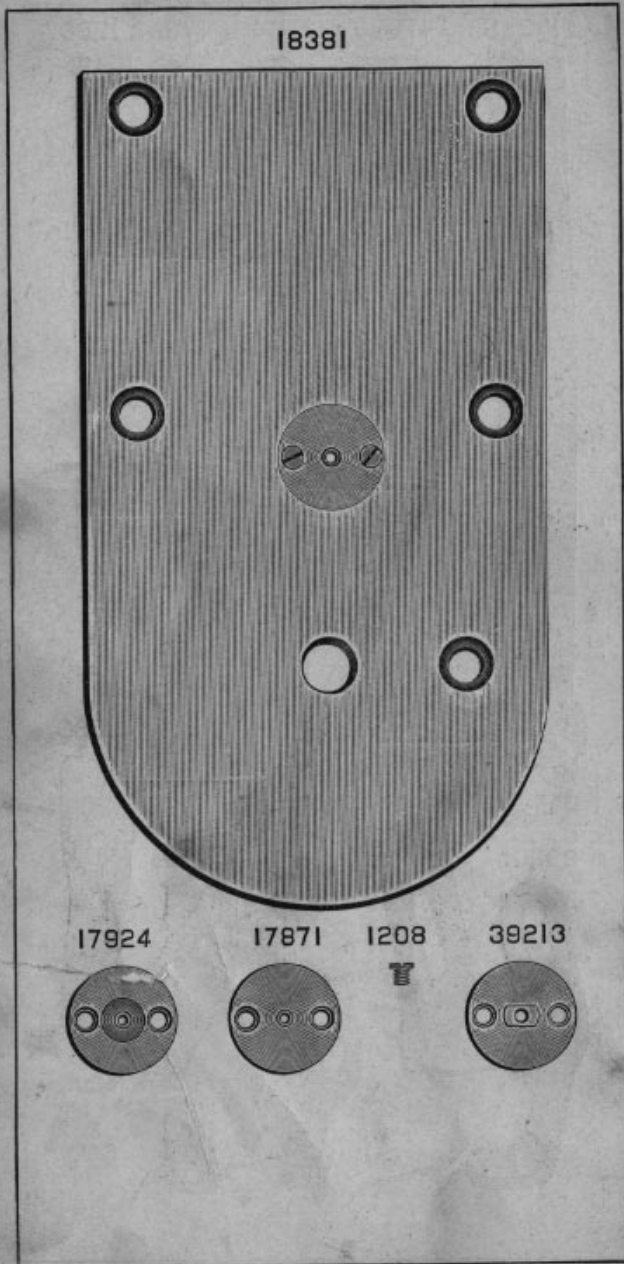

PLATE 5021—FULL SIZE

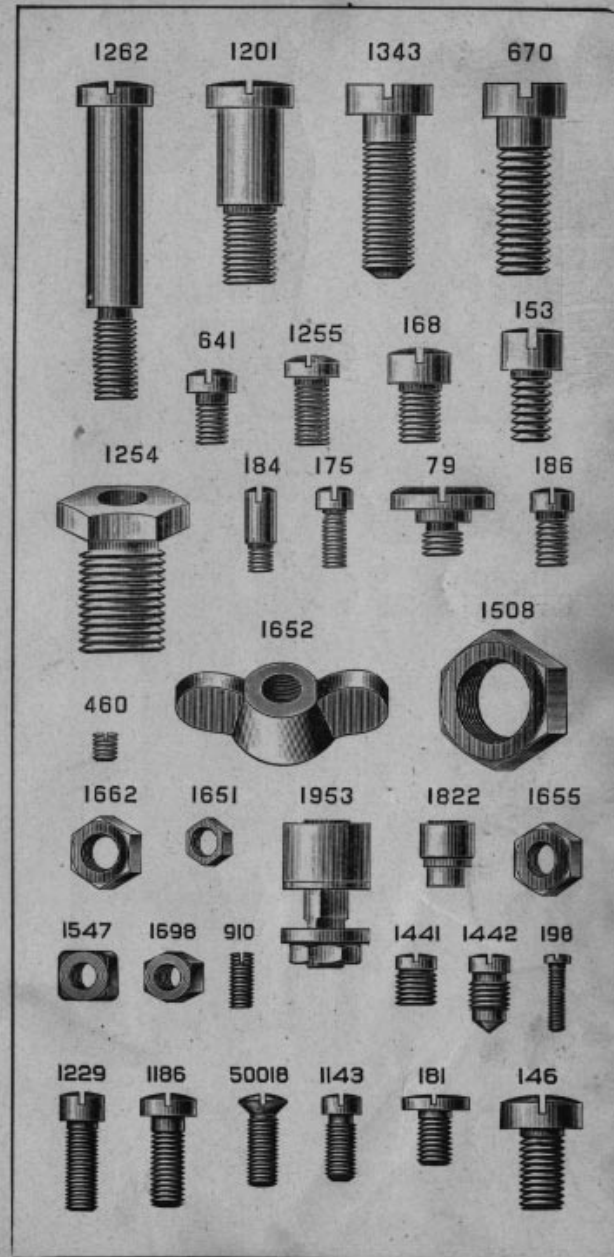

PLATE 5022—ONE-FOURTH SIZE

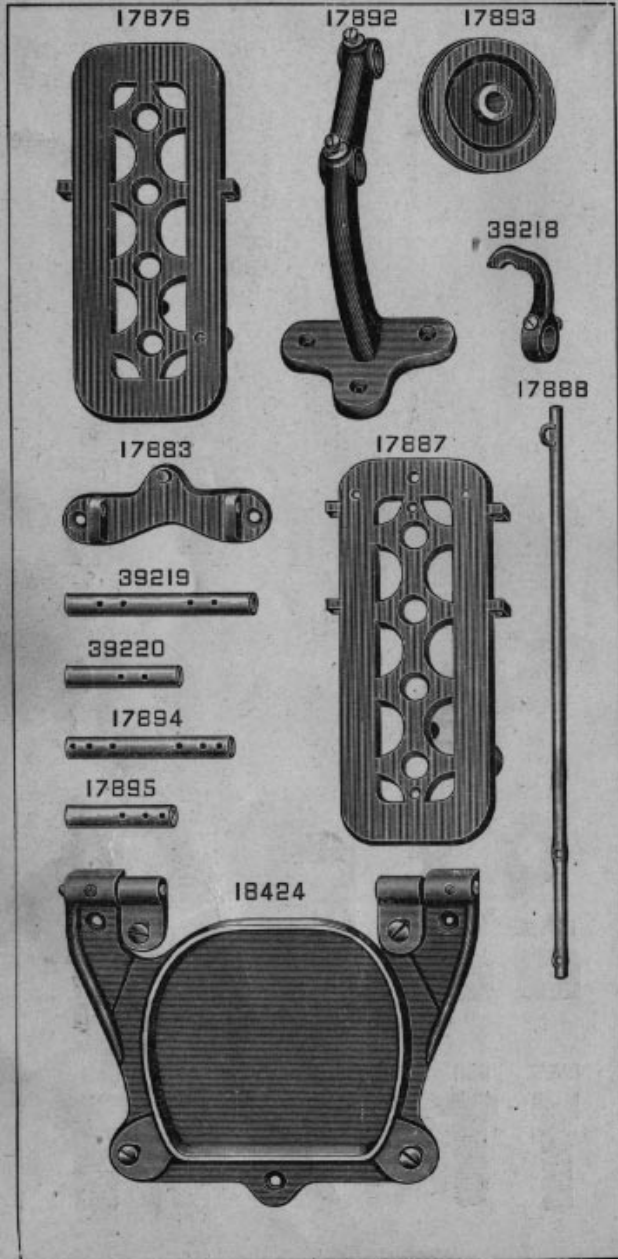

PLATE 5023—ONE-HALF SIZE



PLATE 5024—ONE-HALF SIZE

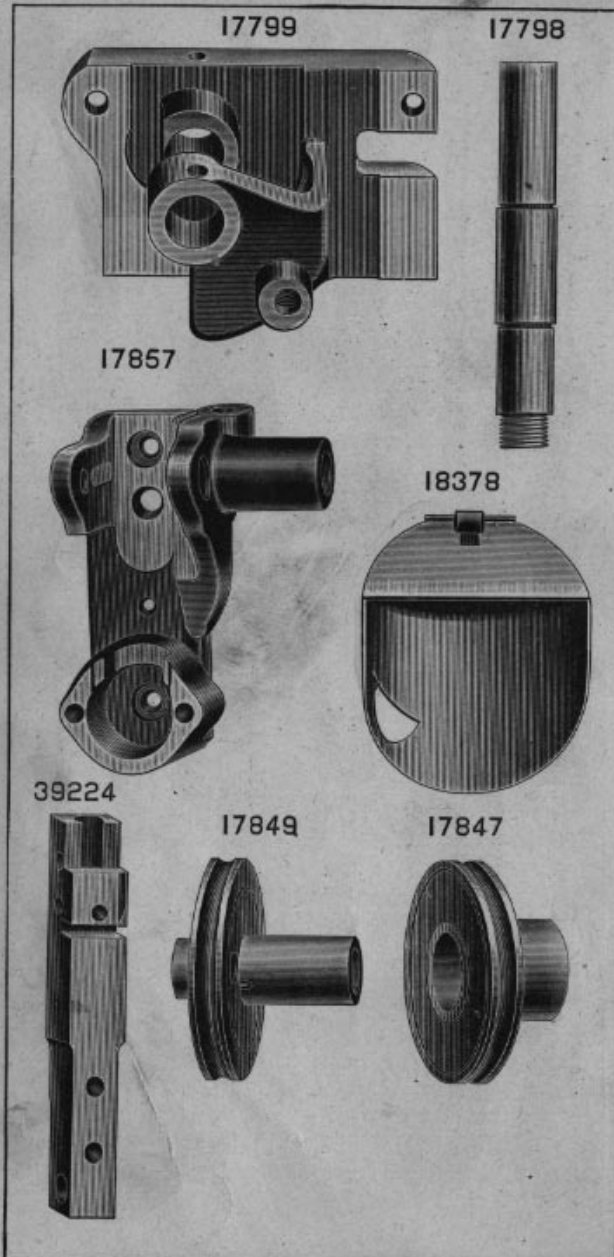

PLATE 5025—FULL SIZE

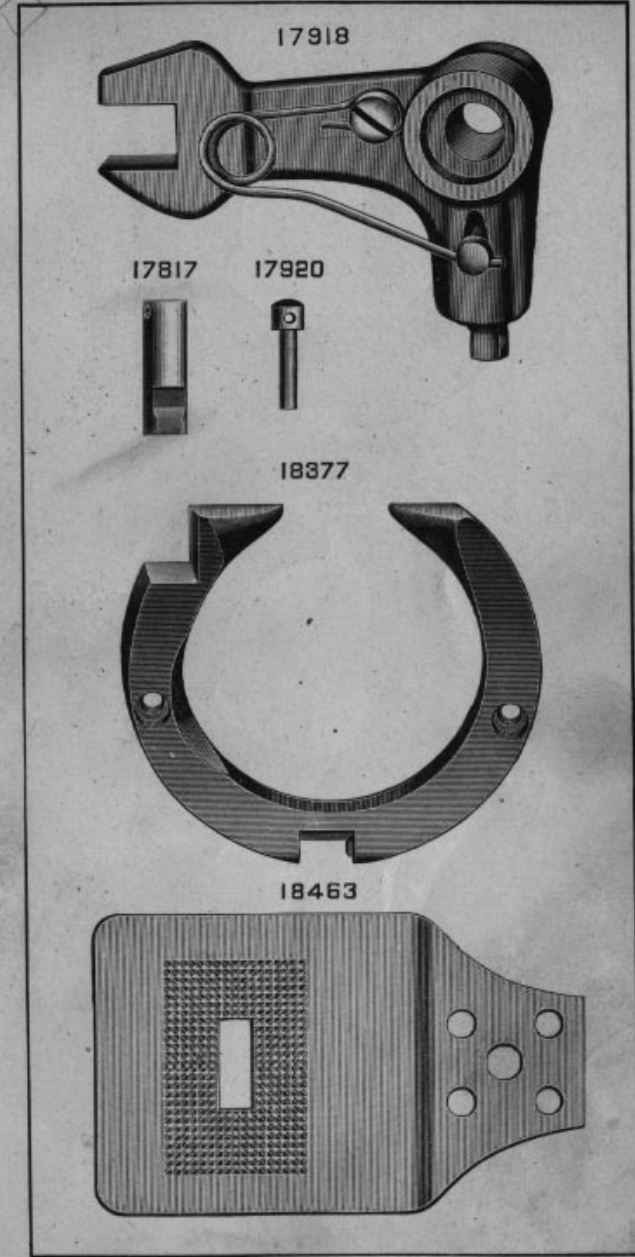
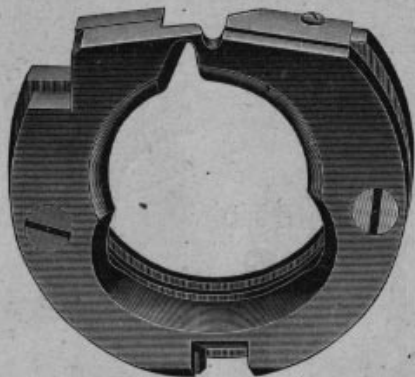

PLATE 5026—FULL SIZE

18414



18412

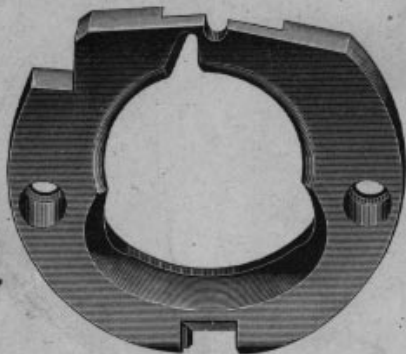
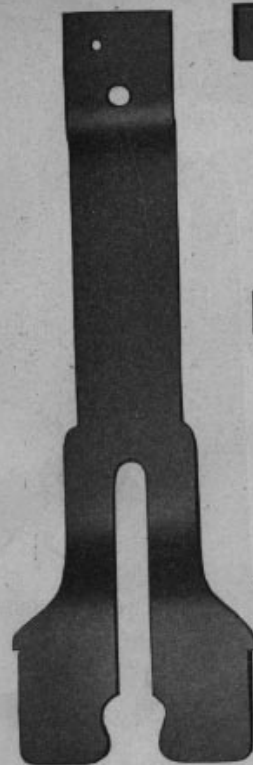

PLATE 5027—FULL SIZE

39340



39342



18460

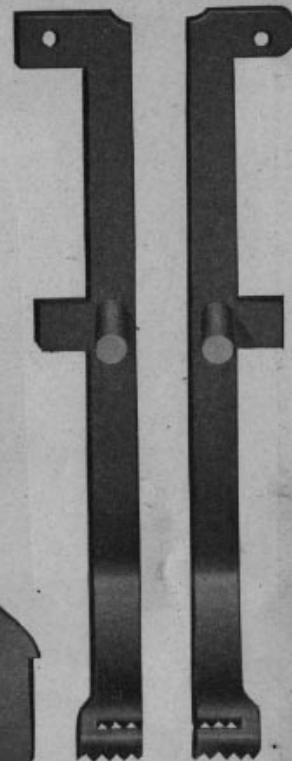

15098



18461

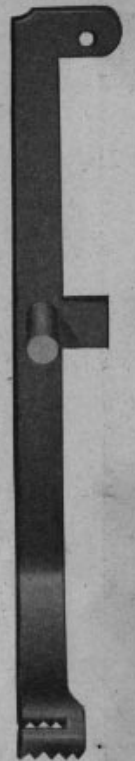

15142



PLATE 5028—ONE-HALF SIZE

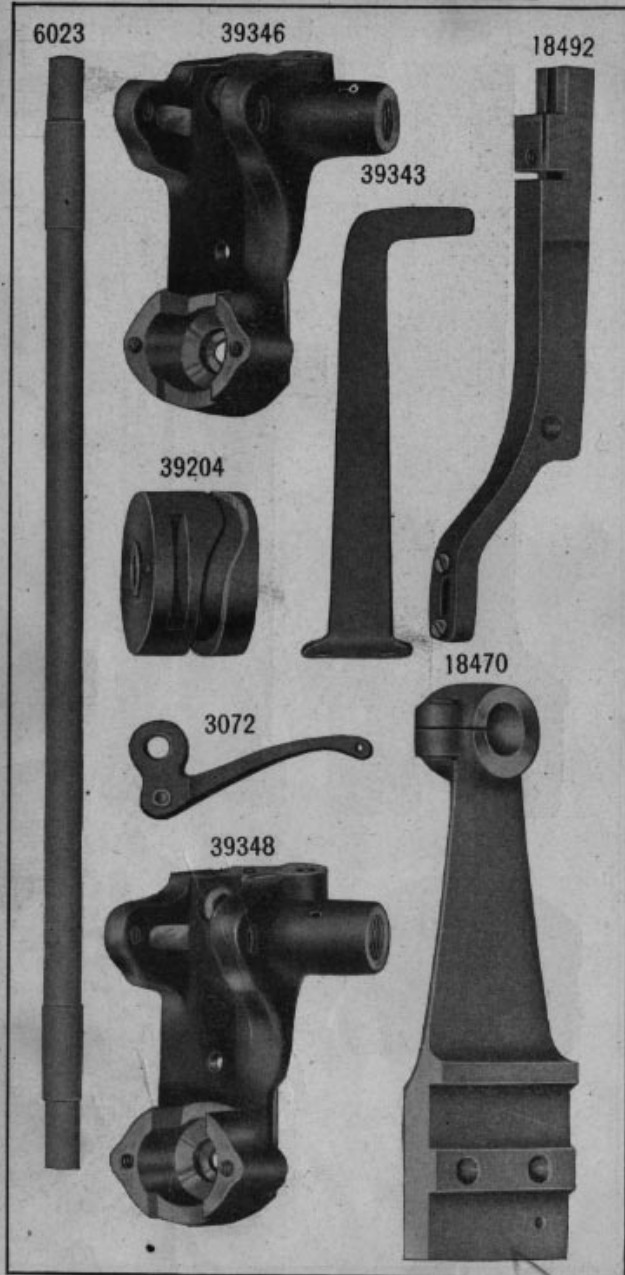

PLATE 5029—ONE-HALF SIZE

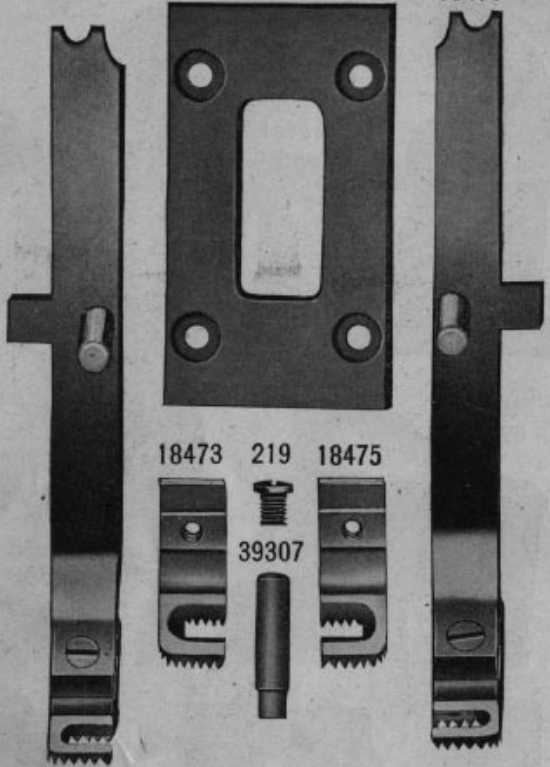

PLATE 5030-FULL SIZE

18474

18477

18476



18473

219

18475

39307

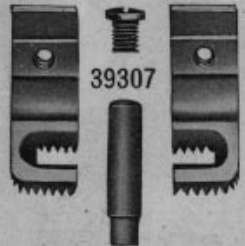

18484

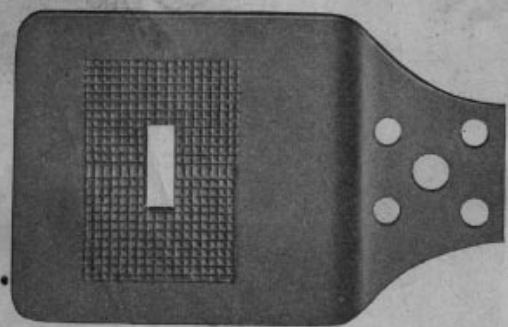

PLATE 5031—ONE-HALF SIZE

18482

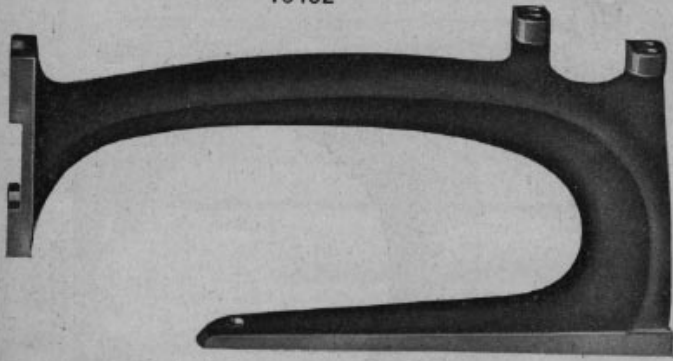

PLATE 5032—FULL SIZE

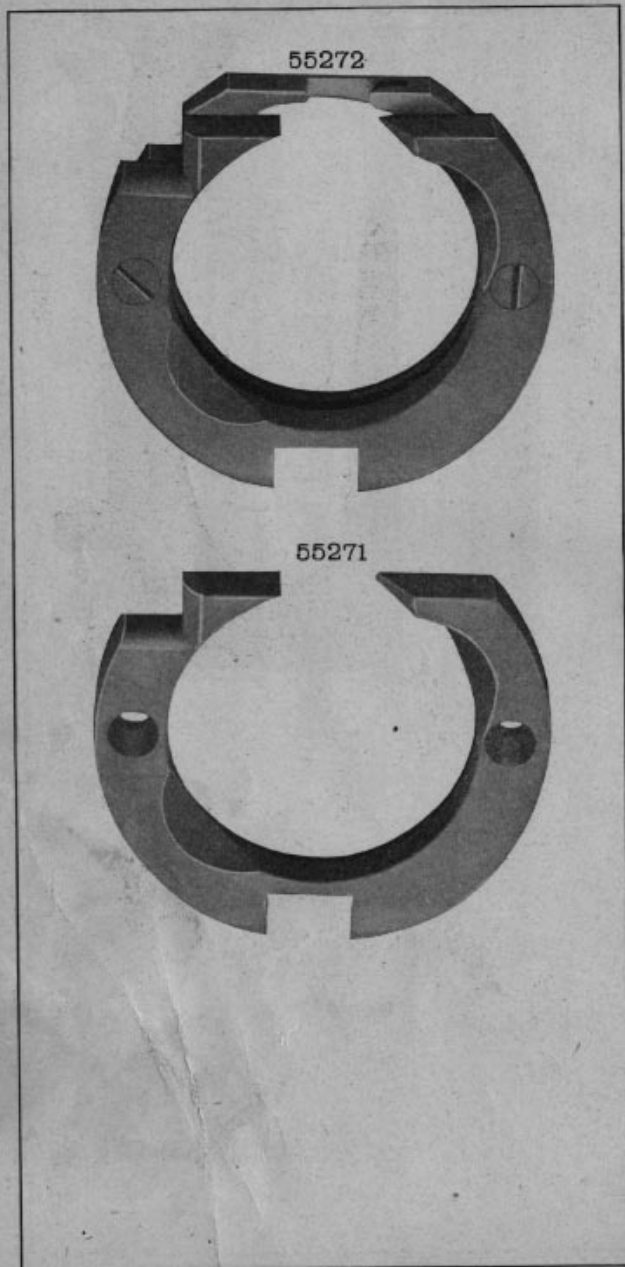

PLATE 5033—ONE FOURTH SIZE

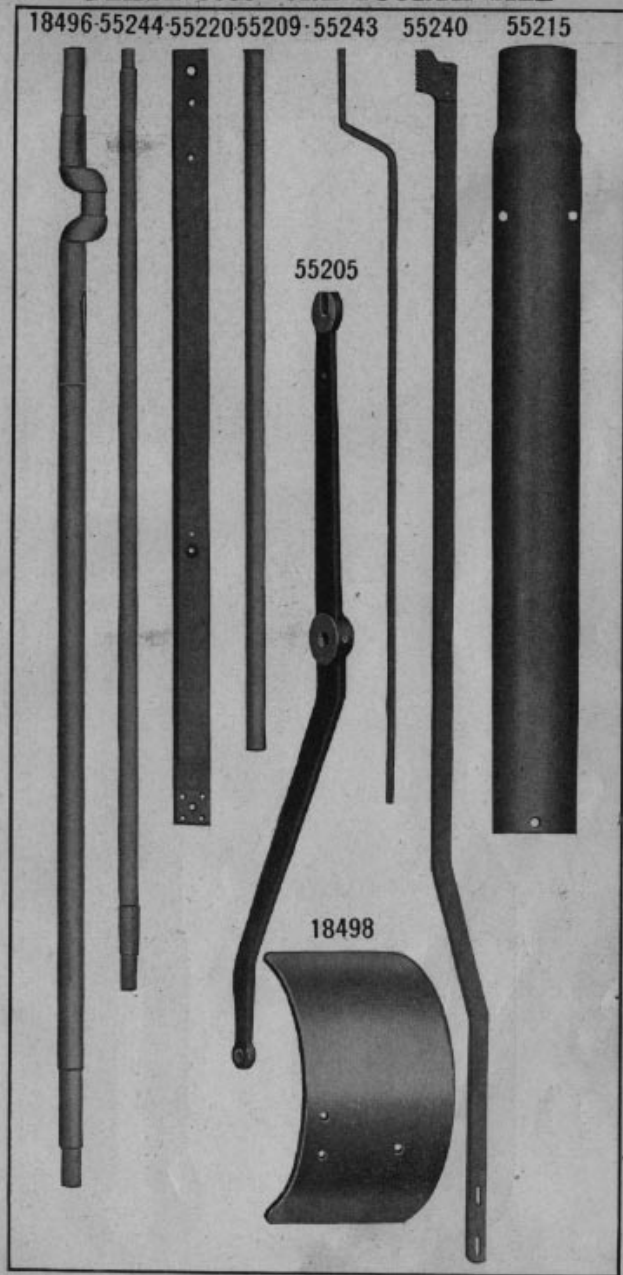

PLATE 5034—FULL SIZE

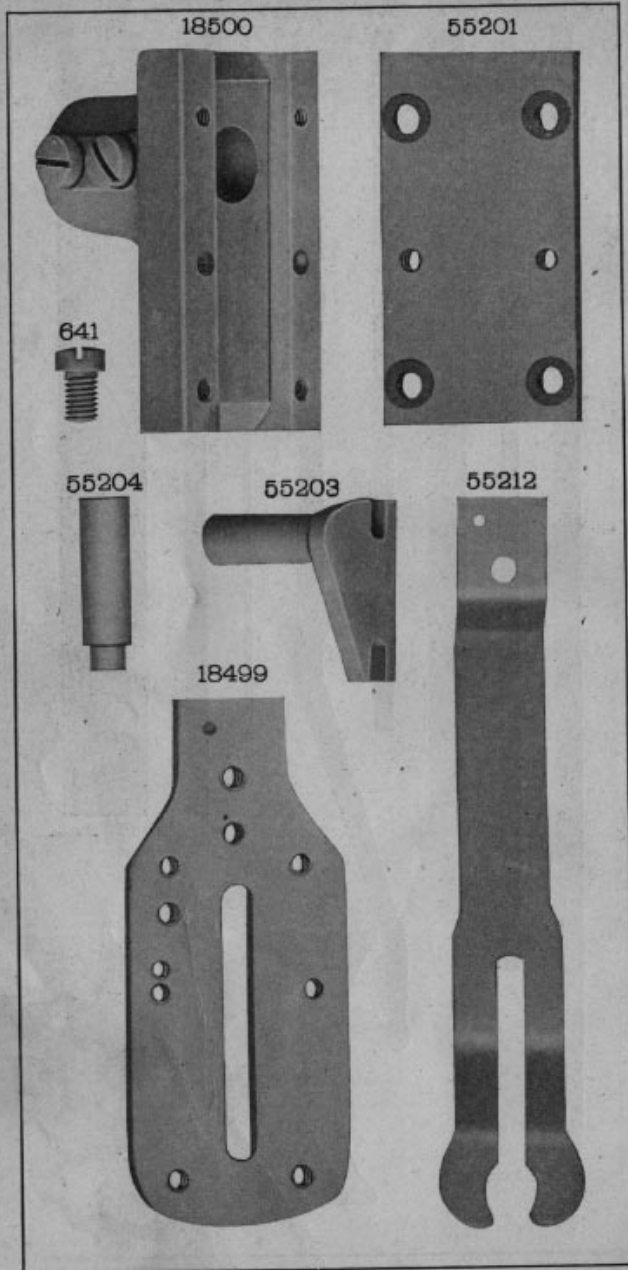

PLATE 5035—ONE-HALF SIZE

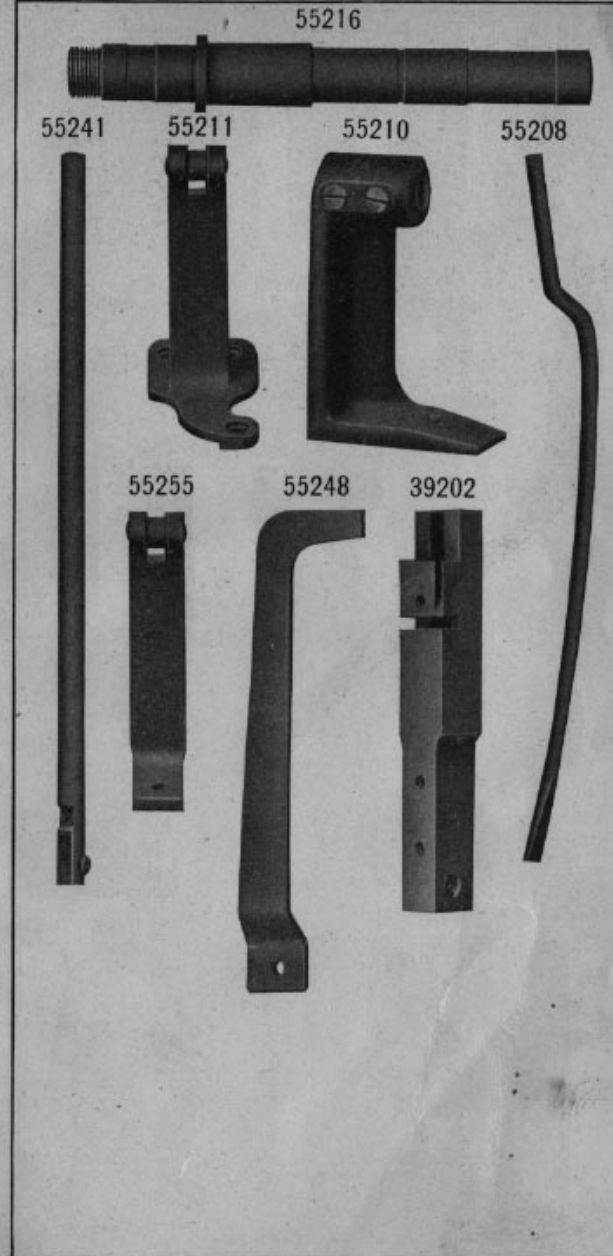

PLATE 5036—FULL SIZE

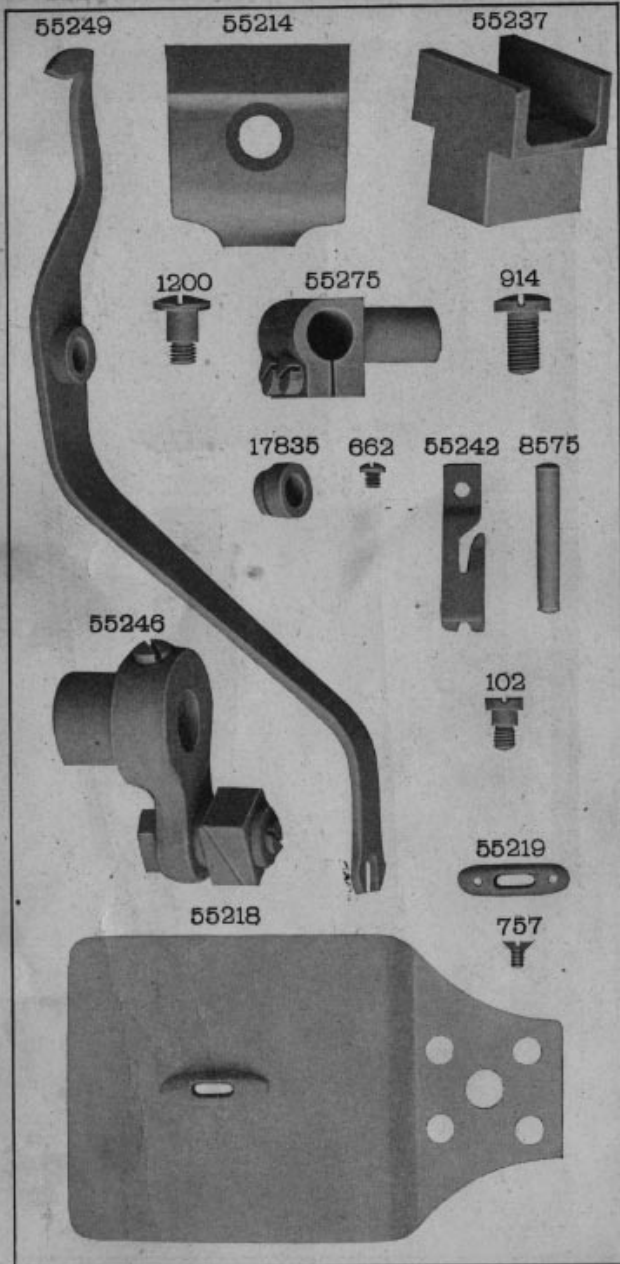

PLATE 5037—FULL SIZE

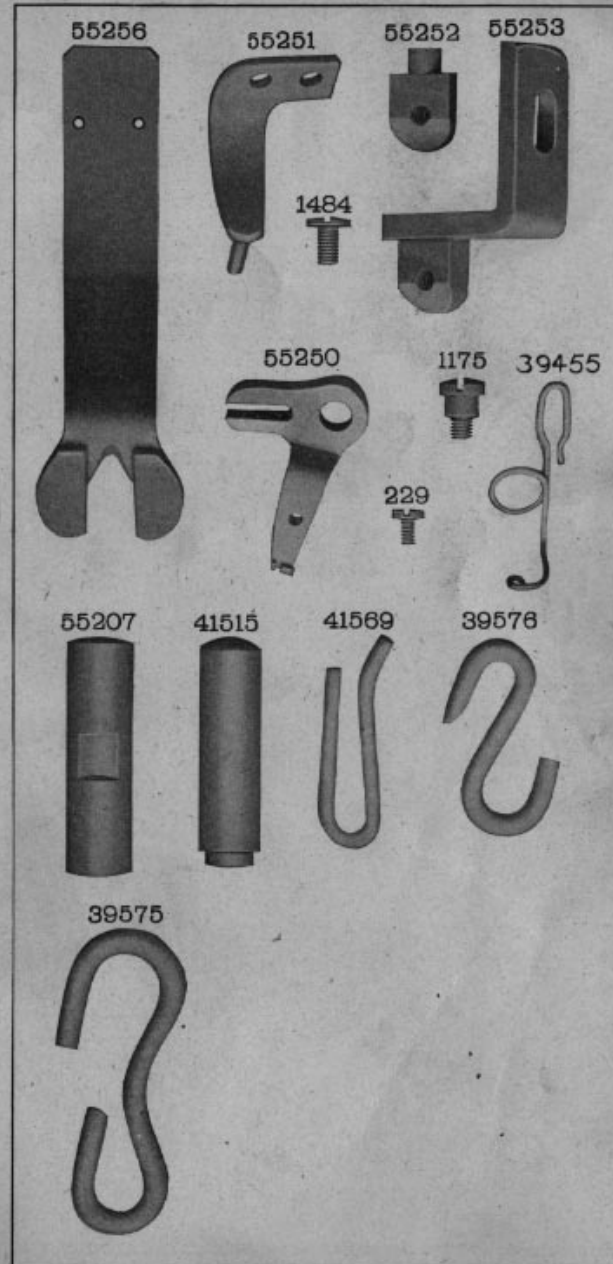

PLATE 5038—FULL SIZE

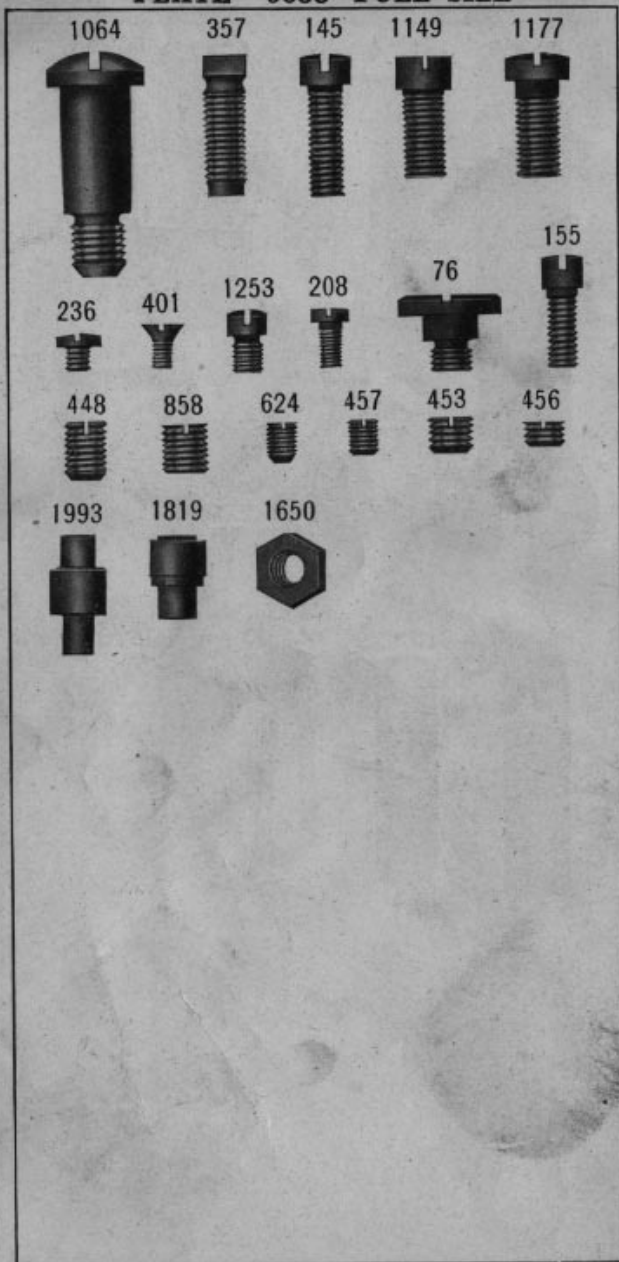

PLATE 5039—ONE-FOURTH SIZE

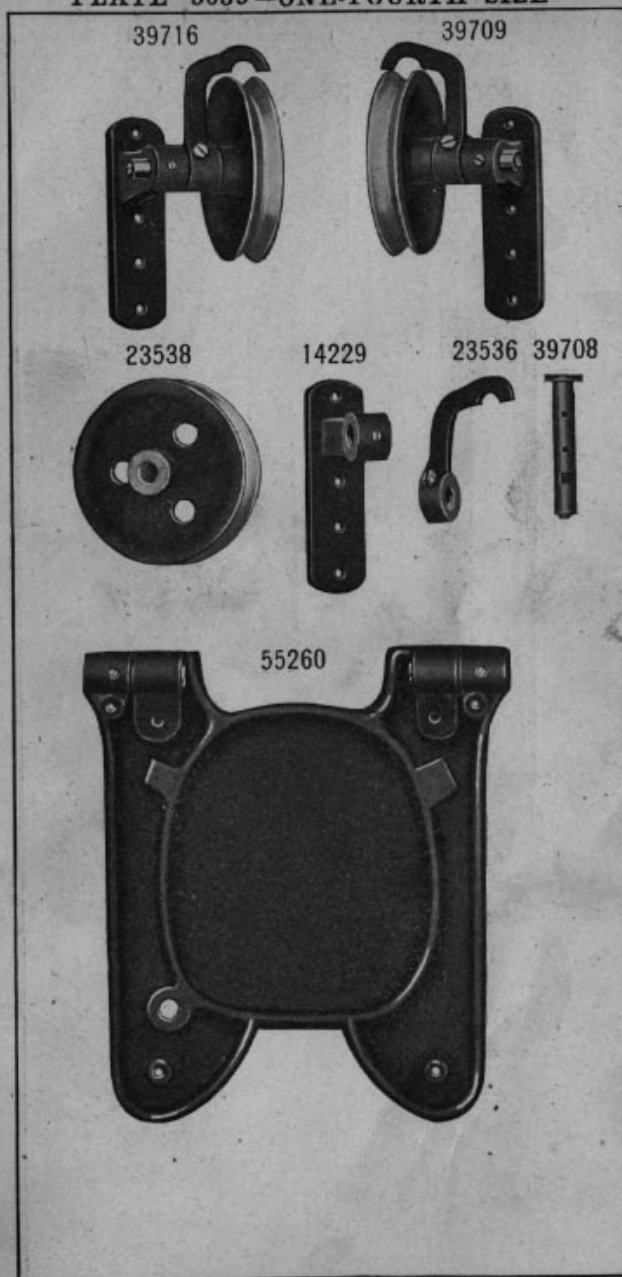

PLATE 5040—ONE-FOURTH SIZE

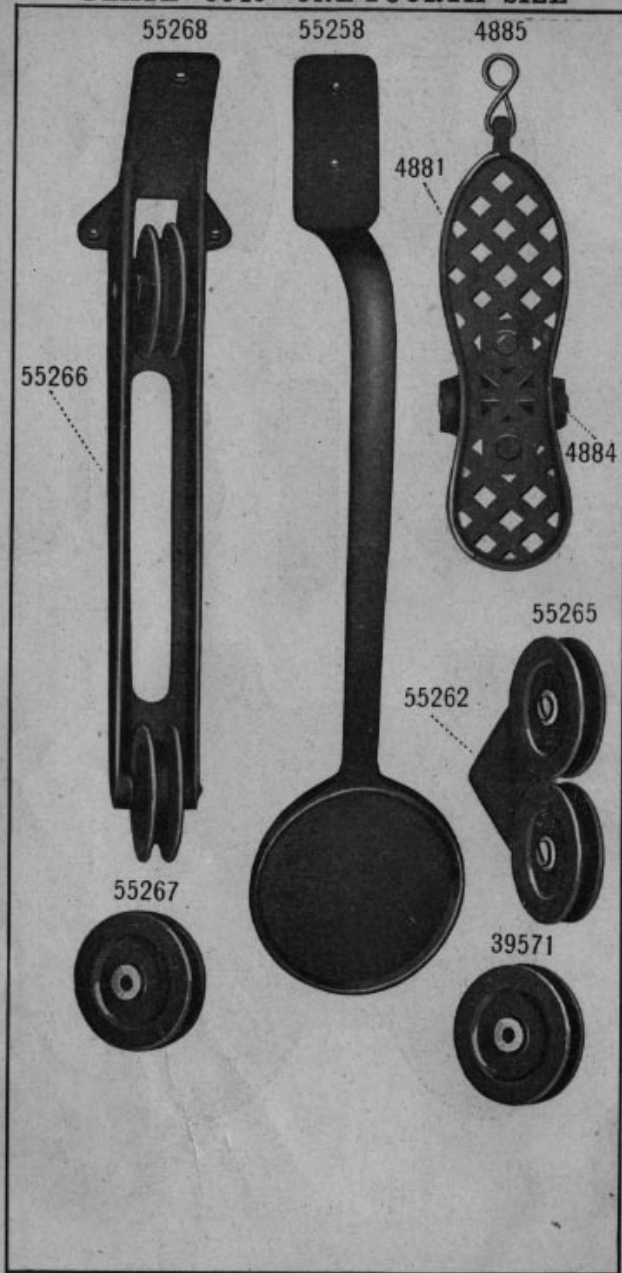

PLATE 5041—ONE-HALF SIZE

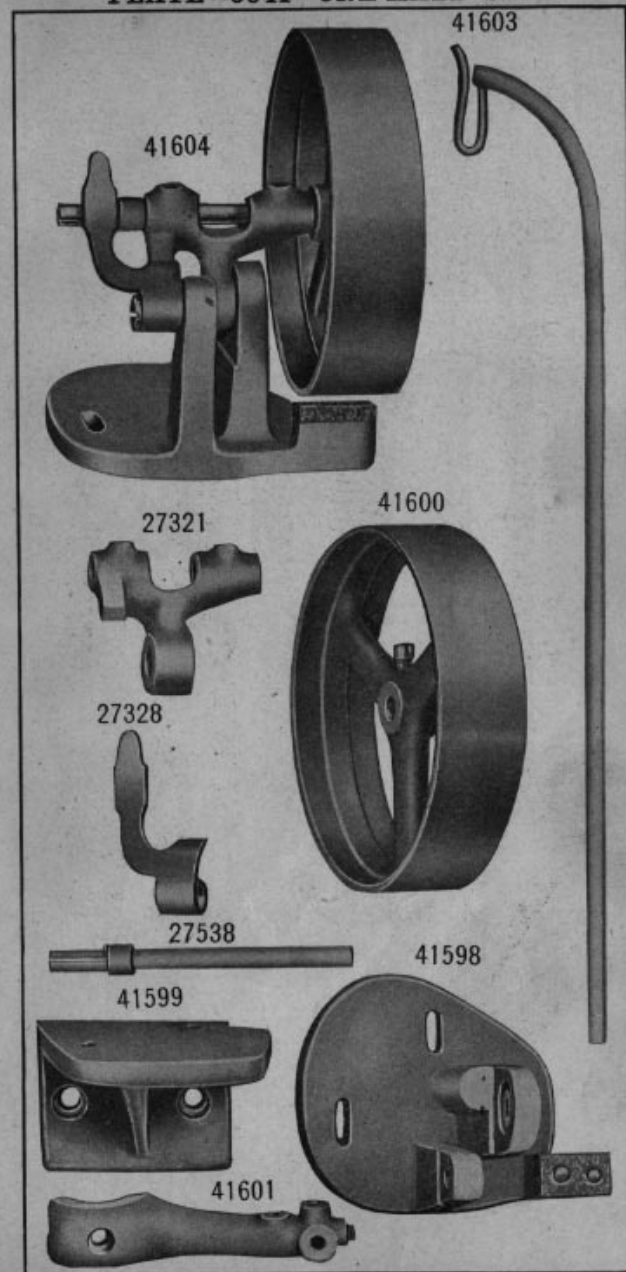

PLATE 5042—FULL SIZE

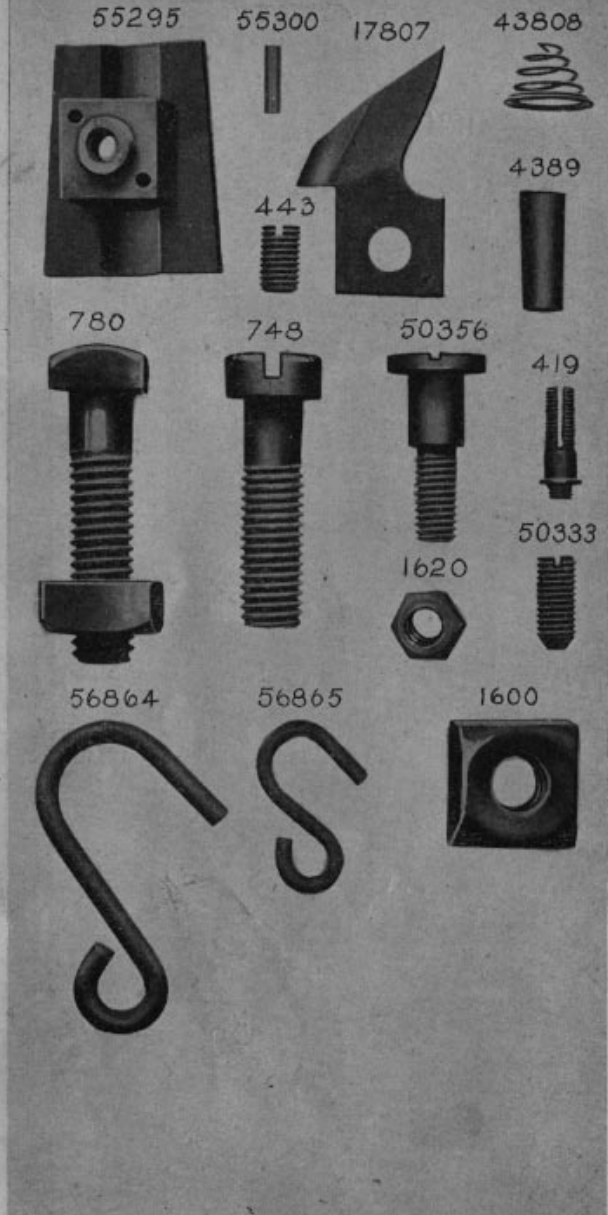

PLATE 7008—ONE-HALF SIZE

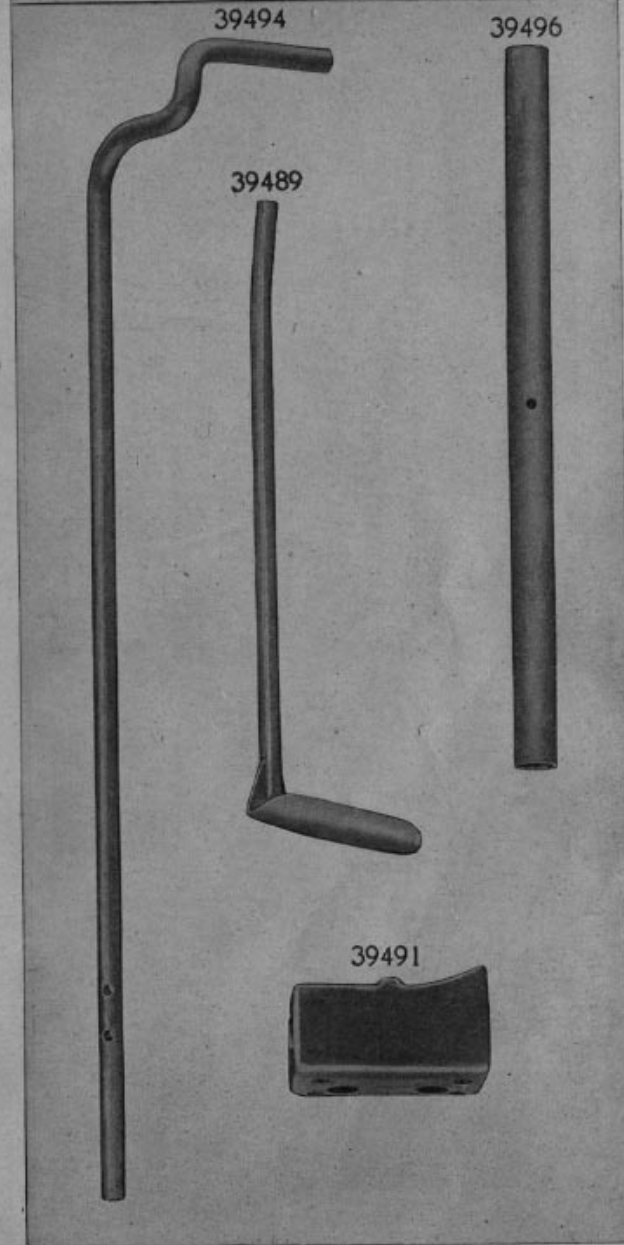

PLATE 7009—FULL SIZE

39492



160



39495



15261



237



52598



176



39497



50351

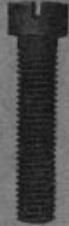

426



1099



454



448



1120



39493

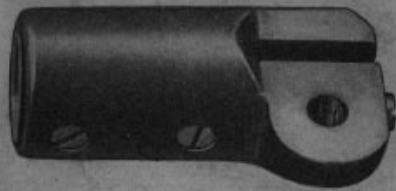
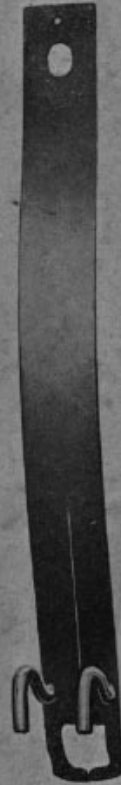

PLATE 7205—ONE-HALF SIZE

63811



63812



63927



63788