

Singer 95-80

Singer 95-100

Form 19145

(238)

Printed in U. S. A.

LIST
OF
PARTS



MACHINES
Nos. 95-80 and 95-100

THE SINGER MANUFACTURING COMPANY

INSTRUCTIONS FOR OILING

Use only Singer "Oil For High Speed Sewing Machines (Cloth and Leather)" for general use, or "Stainless Oil For High Speed Sewing Machines" where a stainless oil is desired.

Oil should be applied to all oil holes and bearings of the machine at least four times a day. Keep all wicking saturated with oil.

The upper and lower gears of the upright arm shaft should be greased with Singer Gear Lubricant every 160 hours of operation, using an Alemite-Zerk grease gun as instructed in Form 19067.

Copyright, U. S. A., 1921, 1922, 1933,
1935, 1937 and 1938
by The Singer Manufacturing Co.
All Rights Reserved for all Countries

INDEX

	Page
Accessories.....	15
Binder on Shank.....	15
Binder (Transverse) on Shank.....	15
Bobbin Winders.....	16
Finger Guards.....	19
Fittings for Dress Shirts.....	19
Foot Lifter Parts.....	21
Hemmers (Foot).....	22
Hemmers on Shank.....	23
Knee Lifter Parts.....	25
Machine Base.....	27
Machine No. 95-80.....	5
Machine No. 95-100.....	13
Numerical List of Parts.....	33
Piping Attachment.....	27
Presser Feet.....	27
Ruffler.....	28
Thread Unwinder.....	29
Tuckers (Long Arm).....	29

INSTRUCTIONS FOR ORDERING

In ordering from this list, use ONLY the part NUMBER in the FIRST column.

The number stamped on a Sewing Machine Part is in every case the number of the single part only.

Every combination of parts sent out as such has its specific number, which, although not stamped on the parts, must be used when ordering the combination.

Each number always indicates the SAME PART in whatever list it appears, or for whatever machine.

The letters after some of the numbers indicate the style of finish only, as follows:

- A-Hardened, Polished, Nickel Plated and Buffed
- B-Polished, Nickel Plated and Buffed
- C-Hardened Only
- D-Polished Only
- E-Soft, Not Polished
- F-Hardened and Polished
- F.J-Hardened, Polished and Nickel Plated
- G-Bright Rumbled and Nickel Plated
- H-Blue
- J-Nickel Plated Only
- K-Hardened and Nickel Plated
- L-Brass Plated
- M-Oxidized
- N-Japanned, Dull
- P-Japanned, Bright
- R-Merlized
- S-Cadmium Plating
- T-Copper Plated
- T.A-Hardened, Polished, Copper and Nickel Plated and Buffed
- T.B-Copper and Nickel Plated and Polished
- T.J-Copper and Nickel Plated Only
- T.K-Hardened, Copper and Nickel Plated
- T.L-Copper and Brass Plated
- T.M-Copper Plated and Oxidized
- U-Zinc Plated
- V-Silver Plated
- W-Polished and Nickel Plated
- X-Black Oxide, for Iron and Steel
- X.C-Hardened and Black Oxide, for Iron or Steel
- Y-Black Nickel Plated Only
- Z-Chromium Plated
- Z.A-Hardened, Polished, Nickel Plated, Buffed and Chromium Plated
- Z.B-Polished, Nickel Plated, Buffed and Chromium Plated
- Z.C-Hardened and Chromium Plated
- Z.J-Nickel and Chromium Plated

These letters MUST BE USED when they appear in the list; and AFTER the number as in the list.

In this series:

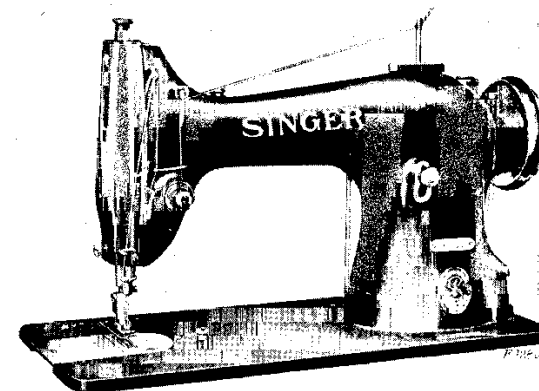
1 to 1500, 50001 to 51500 and 140001 to 142000 are Screw Numbers
 1501 to 1800 and 51501 to 51800 are Nut Numbers
 1801 to 2000 and 51801 to 52000 are Roller Numbers
 2001 to 50000 and 52001 to 140000 and 142001 to 190000 are Sewing Machine Parts, 190001 and upward are numbers of Electrical Parts.

The figures in the second column refer only to the plates, illustrating the parts, and are NOT to BE USED in ordering.

Parts marked with an asterisk (*) are furnished only when repairs are made at factory.

LIST OF PARTS COMPLETE

FOR



MACHINE No. 95-80

For Light and Medium Weight Fabrics. Maximum stitch seven to the inch. Drop feed. The machine is fitted with heavy gear shafts and three plain bearings for the arm shaft. The gears are lubricated with grease instead of oil. The grease is applied with Alemite Zerk hand pressure gun. Needle bar stroke 1 9/64 inches. Speed up to 4200 R. P. M., according to the material being stitched.

No.	Plate	Name
*52252	-----	Arm with 15404 and two each 15405 and 56015.....
Note: Due to the accuracy required for gear alignment, Arm cannot be supplied separately and can only be sent out as a unit, Arm and Bed assembled.		
16532	21836	Arm Dowel Pin.....
52182	21836	" Oil Tube with 52184, for oiling 127231
52183	21836	" " " " 52184, for oiling 52024 and 127156, for 127193 and 150460....
52180	21836	Arm Oil Tube (long) with 52184, for oiling 52022.....

PARTS FOR MACHINE No. 95-80

No.	Plate	Name
52185	21836	Arm Oil Tube (short) with 42367, for oiling 52022.....
127187	21836	Arm Oil Tube with 42367, for oiling 127152 for 127193 and 150460.....
56015	21836	Arm Oil Tube for oiling 142006.....
52254	21836	" " " " " 52262.....
52184	21836	" " " Packing (wick) for 52180, 52182 and 52183.....
42367	21836	Arm Oil Tube Packing (braided cotton) for 52185 and 127187.....
52290	21836	Arm Oil Tube Hole Plug.....
116E	21836	" Screw (back).....
868E	21836	" " (front).....
52255	21838	" Shaft (horizontal).....
52256	-----	" " " 52255 with 52196 and 52246.....
68350	22218	Arm Shaft (horizontal) Back Bearing Oil Cup.....
127072	21837	Arm Shaft (horizontal) Bevel Gear with two 1036C.....
142003	21837	Arm Shaft (horizontal) Bevel Gear Case (two pieces) with 51068R, 140184E and 142005.....
142005	21836	Arm Shaft (horizontal) Bevel Gear Case Alemite Fitting.....
140184E	21836	Arm Shaft (horizontal) Bevel Gear Case Plug Screw.....
51068R	22218	Arm Shaft (horizontal) Bevel Gear Case Screw.....
1036C	22218	Arm Shaft (horizontal) Bevel Gear Set Screw.....
*52259	-----	Arm Shaft (horizontal) Flanged Bushing (back).....
52260	21837	Arm Shaft (horizontal) Flanged Bushing (back) 52259 with 52193 and 52289....
52193	22218	Arm Shaft (horizontal) Flanged Bushing (back) Oil Pad, inside (braided cotton).....
52289	22218	Arm Shaft (horizontal) Flanged Bushing (back) Oil Pad, outside (felt).....
448C	22218	Arm Shaft (horizontal) Flanged Bushing (back) Set Screw.....
*52195	-----	Arm Shaft (horizontal) Flanged Bushing (front).....
52196	21837	Arm Shaft (horizontal) Flanged Bushing (front) 52195 with 52193 and 52198...
52193	22218	Arm Shaft (horizontal) Flanged Bushing (front) Oil Pad, inside (braided cotton).....

PARTS FOR MACHINE No. 95-80

No.	Plate	Name
52198	22218	Arm Shaft (horizontal) Flanged Bushing (front) Oil Pad, outside (felt).....
435C	22218	Arm Shaft (horizontal) Flanged Bushing (front) Set Screw.....
68350	22218	Arm Shaft (horizontal) Front Bearing Oil Cup.....
*52261	-----	Arm Shaft (horizontal) Intermediate Bushing.....
52262	21837	Arm Shaft (horizontal) Intermediate Bushing 52261 with 52193 and 52263.....
52193	22218	Arm Shaft (horizontal) Intermediate Bushing Oil Pad, inside (braided cotton).
52263	22218	Arm Shaft (horizontal) Intermediate Bushing Oil Pad, outside (felt).....
423C	22218	Arm Shaft (horizontal) Intermediate Bushing Set Screw.....
144D	22218	Arm Shaft (horizontal) Screw.....
142006	21837	" " (upright).....
52281	22218	" " " Bevel Gear (lower) with two 1259C.....
1259C	22218	Arm Shaft (upright) Bevel Gear (lower) Set Screw.....
52282	22218	Arm Shaft (upright) Bevel Gear (upper) with two 1259C.....
1259C	22218	Arm Shaft (upright) Bevel Gear (upper) Set Screw.....
*52275	-----	Arm Shaft (upright) Bushing (lower).....
52276	21837	" " " " " 52275 with 52279 and 52280.....
432C	22218	Arm Shaft (upright) Bushing (lower) Set Screw.....
*52277	-----	Arm Shaft (upright) Bushing (upper).....
52278	21837	" " " " " 52277 with 52279 and 52280.....
443C	22218	Arm Shaft (upright) Bushing (upper) Set Screw.....
52280	22218	Arm Shaft (upright) Bushing Oil Pad, outside (felt).....
52279	22218	Arm Shaft (upright) Bushing Oil Wick, inside (braided cotton).....
127146	21806	Arm Side Cap.....
219J	22218	" " " Screw.....
127079	21837	" " " Cover.....
50053W	22218	" " " Thumb Screw.....
52239	22218	" Spool Pin and Thread Eyelet.....
8879	5936	" " " Washer (cloth).....
127192	21837	" Top Cover.....
127193	21837	" " " 127192 with 52183, 52239, 127187 and 127255.....
127255	22218	Arm Top Cover Positioning Disc.....

PARTS FOR MACHINE No. 95-80

No.	Plate	Name
127232	-----	Needle Bar Connecting Link 127231 with 24041.....
775E	21840	Needle Bar Connecting Link Cap Screw.....
52207	21840	" " " " Lubricating Pad (wood).....
24041	21840	Needle Bar Connecting Stud with 207E.....
207E	2834	" " " " Clamping Screw
52246	21841	" " Crank with 1036C, 1037C and 1065C.....
1065C	21840	Needle Bar Crank Position Screw.....
857H	21840	" Set Screw.....
127133	21841	Oil Tube with 52045.....
127091	21841	" " Bracket.....
52167	21841	" " " 127091 with 127133, for oiling 52165.....
52045	21836	Oil Tube Packing (wick).....
12391	21841	Presser Bar (hollow).....
52338	5936	" " Guide Bracket with 223C and 453C.....
453C	5936	Presser Bar Guide Bracket Set Screw.....
52016	5936	" " Lifter.....
689C	5936	" " " Hinge Screw.....
1520J	5936	" " " " Nut.....
12327	5936	" " Lifting and Releasing Lever Bracket.....
127108	21841	Presser Bar Spring.....
11170	5936	" " Washer.....
62527	21839	" Foot Hinge Pin.....
24544	-----	" " Plate.....
24982	-----	" " Shank.....
26231	21839	" " Spring.....
24983	21839	Presser Foot (spring hinged) complete, Nos. 24544, 24982, 26231 and 62527...
176J	22220	Presser Foot Screw.....
688W	21840	Pressure Regulating Thumb Screw.....
127095	21840	Rotating Hook with three 1253C.....
127096	-----	" " 127095 with 127102 and four 1053E.....
*127239	-----	Rotating Hook 127096 with 40274, 127242 and three 1367E.....
127097	-----	Rotating Hook 127096 with 40274 and three 1367E (for Agents only).....
127240	-----	Rotating Hook 127239 with 52237.....
40264	21840	" " Bobbin.....
52235	-----	" " " Case.....
52236	-----	" " " 52235 with 591F 1380E and 40394.....
40392	21840	Rotating Hook Bobbin Case Latch.....
125320	21840	" " " " " Lever....
2974	22224	" " " " " Full-crum Pin.....

PARTS FOR MACHINE No. 95-80

No.	Plate	Name
2975	21840	Rotating Hook Bobbin Case Latch Spring...
592E	22224	" " " " " Stop Screw
40393	-----	" " " " " Hinge, Nos.2974 40392 and 125320.....
591F	22224	Rotating Hook Bobbin Case Tension Regulating Screw.....
40394	21840	Rotating Hook Bobbin Case Tension Spring.
1380E	22224	" " " " " " Screw.....
52237	22224	Rotating Hook Bobbin Case complete, Nos. 592E, 2975, 40393 and 52236.....
127241	-----	Rotating Hook Bobbin Case 52237 with 127242.....
127242	22224	Rotating Hook Bobbin Case Holder.....
52018	22224	" " " " " Position Bracket.....
704J	22224	Rotating Hook Bobbin Case Holder Position Bracket Screw.....
40274	22224	Rotating Hook Section.....
1367E	22224	" " " Screw.....
1253C	22224	" " Set Screw.....
142007	21838	" " Shaft.....
127073	22224	" " " Bevel Gear with two 1259C.....
142004	21841	Rotating Hook Shaft Bevel Gear Case (two pieces) with 51066R, 140184E and 142005.....
142005	21836	Rotating Hook Shaft Bevel Gear Case Alemite Fitting.....
140184E	21836	Rotating Hook Shaft Bevel Gear Case Plug Screw.....
51066R	22218	Rotating Hook Shaft Bevel Gear Case Screw
1259C	22218	" " " " " Set Screw.
*52285	-----	" " " Bushing (back).....
52286	21841	" " " " " 52285 with 52279 and 52280.....
1148C	22224	Rotating Hook Shaft Bushing (back) Set Screw.....
*52287	-----	Rotating Hook Shaft Bushing (front).....
52288	21841	" " " " " 52287 with 52279 and 52280.....
142008	22224	Rotating Hook Shaft Bushing (front) Oil Cup.....
1148C	22224	Rotating Hook Shaft Bushing (front) Set Screw.....
52280	22218	Rotating Hook Shaft Bushing Oil Pad, outside (felt).....
52279	22218	Rotating Hook Shaft Bushing Oil Wick, inside (braided cotton).....
127102	22224	Rotating Hook Thread Guard.....
1053E	22224	" " " " " Screw.....

PARTS FOR MACHINE No. 95-80

No.	Plate	Name
52337	5936	Slack Thread Regulator.....
223C	5936	" " " Set Screw.....
2102	3471	Tension Disc.....
1560C	22224	" Regulating Thumb Nut.....
32572	21842	" Releasing Disc.....
43944	5936	" " Lever.....
12398	5936	" " " Hinge Pin.....
12329	5936	" " " Spring.....
32574	21842	" " Pin.....
13710	21842	" Spring.....
50304C	21842	" Stud.....
52098	"	" 50304C with 1560C.....
50305C	22224	" " Set Screw.....
52092	-----	Tension complete, Nos. 13710, 32572, 32574 52082, 52083, 52098 and two 2102.....
52171	21842	Thread Eyelet, for 52268.....
52027	21842	" Guard (side of arm).....
52454	22224	" Retainer.....
624C	22224	" " Set Screw.....
52269	-----	Thread Take-up complete, Nos. 11204, 52025 and 52270.....
52218	22224	Thread Take-up Crank.....
52270	-----	" " " 52218 with 775E and 127232.....
1037C	21842	Thread Take-up Crank Position Screw.....
1036C	22218	" " " Set Screw.....
52022	21842	" " Lever with 52130.....
52023	21842	" " " Hinge Pin.....
52024	21842	" " " Link.....
11204	21842	" " " " Hinge Pin.....
435C	22218	" " " " " " Set Screw.....
52130	21842	Thread Take-up Lever Thread Eyelet Bush- ing.....
52025	-----	Thread Take-up Lever complete, Nos. 52022 to 52024.....
52082	21842	Thread Take-up Spring.....
52083	21842	" " " Regulator with 50305C
448C	22218	" " " Set Screw.
52032	21853	Throat Plate, large needle hole, for 52031
52033	21839	" " small needle hole, for 52031
Note: Throat Plate No. 52033 is sent with this ma- chine unless otherwise specified on order.		
691F	21839	Throat Plate Screw.....
*15404	-----	Trade Mark.....
15405	-----	" " Rivet.....
24079	5877	Drip Pan.....

MACHINE No. 95-100

For Light and Medium Weight Fabrics. Maximum stitch seven to the inch. Drop feed. The machine is fitted with heavy gear shafts; a plain bushed intermediate bearing, also front and rear ball bearings for the arm shaft. The gears are lubricated with grease instead of oil. The grease is applied with Alemite Zerk hand pressure gun. Needle bar stroke 1 9/64 inches. Speed up to 4200 R. P. M., according to the material being stitched.

NOTE: THIS MACHINE IS THE SAME AS THE 95-80 MACHINE
WITH THE FOLLOWING EXCEPTIONS:

No.	Plate	Name
*52253	-----	Arm with 15404 and two each 15405 and 56015, in place of 52252.....
Note: Due to the accuracy required for gear align- ment, Arm cannot be supplied separately and can only be sent out as a unit, Arm and Bed assem- bled.		
52257	21838	Arm Shaft (horizontal) with 127067, in place of 52255.....
52258	-----	Arm Shaft (horizontal) 52257 with 52214, in place of 52256.....
54897	21842	Arm Shaft (horizontal) Back Bearing Oil Cup, in place of 68350.....
52146	21842	Arm Shaft (horizontal) Back Bearing Oil Cup Pad (braided cotton).....
127011	21841	Arm Shaft (horizontal) Ball Bearing (back) in place of 52260.....
*127143	-----	Arm Shaft (horizontal) Ball Bearing (back) Cover.....
127144	21841	Arm Shaft (horizontal) Ball Bearing (back) Cover 127143 with 127145.....
*127145	-----	Arm Shaft (horizontal) Ball Bearing (back) Cover Oil Lead.....
219J	22218	Arm Shaft (horizontal) Ball Bearing (back) Cover Screw.....
52486	21842	Arm Shaft (horizontal) Ball Bearing (back) Locking Pin.....

No.	Plate	Name
52487	21842	Arm Shaft (horizontal) Ball Bearing (back) Locking Pin Cone.....
446C	21842	Arm Shaft (horizontal) Ball Bearing (back) Locking Pin Cone Screw.....
127066	21841	Arm Shaft (horizontal) Ball Bearing (front) in place of 52196.....
127009	21841	Arm Shaft (horizontal) Ball Bearing (front) Cover.....
401E	21842	Arm Shaft (horizontal) Ball Bearing (front) Cover Screw.....
127067	21842	Arm Shaft (horizontal) Ball Bearing (front) Key.....
52240	21837	Arm Shaft (horizontal) Bevel Gear Case Holder, in place of 52259.....
54897	21842	Arm Shaft (horizontal) Front Bearing Oil Cup, in place of 68350.....
52146	21842	Arm Shaft (horizontal) Front Bearing Oil Pad (braided cotton).....
52247	21841	Needle Bar Crank with 1036C, 1037C and 1065C.....
52214	-----	Needle Bar Crank 52247 with 401E and 127009, in place of 52246.....

Genuine Singer Needles should be used in Singer Machines. These Needles and their Containers are marked with the Company's Trade Mark "SIMANCO." 1

Needles in Containers marked "For Singer Machines" are not Singer made needles. 2

ACCESSORIES

No.	Plate	Name
121587	21838	Grease Gun (3 oz. capacity) for Fitting No. 142005.....
121588	-----	Grease Gun (1/2 lb. capacity) for Fitting No. 142005.....
20022	21843	Machine Cushion (felt).....
27878	21843	" " Rivet.....
12361	21843	" " Hinge Connection.....
44139	21843	" " Plate.....
44140	-----	Machine Hinge complete, Nos. 12361, 44139 and merlized wood screw 1-1/4 in. No. 14.....
41400	22226	Machine Rest Pin (wood).....
120342	21835	Oiler (copper plated) with 120343.....
120343	21835	" Spout, 3-1/2 in. long.....
26026	21835	Screw Driver (large).....
26485	21835	" " (small).....
8909	21835	Wrench for 1513 and 1518.....
8908	21835	" " 1519 and 1520.....

BINDER ON SHANK

No.	Plate	Name
35208	1971	Binder on Shank, to turn in both edges, for bias or straight binding, for skirts, wrappers, shirt waists, etc..
26603	21818	Feed Dog, 20 teeth (16 teeth to the inch) for 26605 and 26606.....
52055	21819	Presser Foot.....
26605	21818	Throat Plate, large needle hole, for 26603
26606	-----	" " small needle hole, for 26603

BINDER (Transverse) ON SHANK

FOR 3/4 IN., 7/8 IN. and 1 IN. TAPE

FOR FOLDED OR UNFOLDED BIAS BINDING (With Tape Reel)

FOR GENERAL WORK

No.	Plate	Name
121167	-----	Binder Folder on Shank.....
43525	21854	" Steady Pin.....

ACCESSORIES

No.	Plate	Name
51097J	21843	Binder Thumb Screw.....
3146	21843	" " " Washer.....
121397	21818	Feed Dog, 18 teeth (16 teeth to the inch) for 121398.....
121169	21819	Presser Foot.....
121412	21819	Tape Reel Arm with 8879, 11656 and 120537
11656	21819	" " " Steady Pin.....
51097J	21843	" " " Thumb Screw.....
120536	22226	" " Disc with 120538 and 120539....
120537	-----	" " " Pin.....
120538	-----	" " " Stud (wood).....
120539	-----	" " " Sleeve.....
8879	5936	" " Washer (cloth).....
121398	21818	Throat Plate with 43525, for 121397.....
121168	-----	Binder (transverse) on Shank complete, Nos. 3146, 120536, 121167, 121169, 121397, 121398, 121412 and two 51097J

BOBBIN WINDERS

BOBBIN WINDER

(SWINGING AUTOMATIC, LEFT HAND)

No.	Plate	Name
41913	21834	Bracket with 457C.....
41583	21834	Frame with 457C.....
34105	21834	" Hinge Pin.....
457C	21843	" " " Set Screw.....
41914	21834	" Spring.....
41585	21834	Pulley with 171J.....
171J	21843	" Set Screw.....
41586	21834	Spindle.....
41587	21834	Stop Latch.....
42614	21843	" " Hinge Stud.....
457C	21843	" " " Set Screw.....
7958	21843	" " Stop Pin.....
41588	21834	" " Tripping Arm with 185H.....
185H	21843	" " " Clamping Screw...
150459	21834	Tension Bracket with 460C.....
150460	-----	Tension Bracket complete, Nos. 41593 to 41595, 52183, 52239, 127187, 127255, 150459 and two 2455.....
127255	22218	Tension Bracket Positioning Plate.....
158J	22218	" " Screw.....
52239	22218	" " Spool Pin and Thread Eye- let.....

BOBBIN WINDER

No.	Plate	Name
8879	5936	Tension Bracket Spool Pin Washer (cloth).
2455	2834	" Disc.....
41593	5936	" Spring.....
41594	5936	" Stud.....
460C	21843	" " Set Screw.....
41595	5936	" Thread Guide.....
60845	-----	Bobbin Winder, Nos. 7958, 34105, 41583, 41585 to 41588, 41913, 41914 and 42614
41915	21834	Bobbin Winder 60845 with 880E and 25446..
150461	-----	Bobbin Winder (swinging automatic, left hand) complete, Nos. 41915 and 150460
880E	21843	Bobbin Winder Screw.....
25446	21843	" " " Washer.....

BOBBIN WINDER

(SWINGING AUTOMATIC, RIGHT HAND)

No.	Plate	Name
41339	2833	Base.....
41340	2833	Frame.....
1429D	2834	" Hinge Screw.....
41341	2833	" Spring.....
207J	2834	" " Screw.....
41342	2833	Pulley with 200F.....
200F	2834	" Set Screw.....
41343	2834	Spindle.....
27306	2834	Spool Pin.....
27307	2833	" Stand.....
27308	2833	Spool Stand complete, Nos. 418E, 1562J, 2106, 10141, 11241, 27306, 27307 and two each 2455 and wood screws 1 in. No. 10.....
11241	2833	Spool Washer (cloth).....
41344	2834	Stop Latch.....
41345	2834	" " Finger.....
152F	2834	" " " Screw.....
1430D	2834	" " Hinge Screw.....
1550H	2834	" " " Nut.....
41346	2834	" " Lever.....
1430D	2834	" " " Hinge Screw.....
2455	2834	Tension Disc.....
1562J	2834	" Regulating Thumb Nut.....
418E	2834	" Screw Stud.....
10141	2834	" Spring.....
2106	2834	" Thread Guide.....
60456	-----	Bobbin Winder, Nos. 152F, 207J, 1429D, 1550H, 41339 to 41346 and three 1430D

BOBBIN WINDER

No.	Plate	Name
41347	2833	Bobbin Winder, Nos. 60456 and two each 9331 and wood screws 1 in. No. 10 R.H.....
41348	-----	Bobbin Winder (swinging automatic, right hand) complete, Nos. 27308 and 41347.
9331	2834	Bobbin Winder Washer.....

BOBBIN WINDER

(SWINGING AUTOMATIC, RIGHT HAND)

FOR POWER TABLE

No.	Plate	Name
225433	3469	Bobbin Winder and Tension Bracket Base...
225453	3470	Frame with 202277 and 225438.....
225454	3471	" Hinge Pin.....
202277	3471	" Oil Packing (wick).....
225438	3471	" " Well Cap.....
225455	3471	" Spring.....
225456	3471	" " Plunger.....
202473	3470	Pulley with 200380C.....
200380C	3471	" Set Screw.....
225381	3470	Spindle.....
225444	3471	Stop Latch.....
200056E	3471	" " Screw.....
225458	3471	" " Thumb Lever.....
225459	3471	" " " " Hinge Stud.....
225459	3471	" " " " Joint Stud.....
202478	3471	" " Trip Lever.....
200299H	3471	" " " " Hinge Screw.....
225461	3471	Tension Bracket with 201499B.....
200082D	3471	" " Screw.....
228026	-----	" " Washer.....
2102	3471	" Disc.....
202407	3471	" Spring.....
201499B	3471	" Stud.....
201572B	3471	" " Thumb Nut.....
225462	-----	Tension Bracket complete, Nos. 201572B, 202407, 225461 and two 2102.....
225382	3469	Bobbin Winder complete, Nos. 200056E, 200082D, 200299H, 202473, 202478, 225381, 225433, 225444, 225453 to 225456, 225458, 225462, 228026, two each 225459 and wood screws 3/4 in. No. 12 R.H.....

FINGER GUARDS

No.	Plate	Name
121326	21844	Finger Guard.....
36819	21844	" " Friction Washer.....
36820	21844	" " Holder with 196J.....
196J	21844	" " " Set Screw.....
50316J	21844	" " Screw.....
121327	21844	Finger Guard (metal) complete, Nos. 36819 36820, 50316J and 121326.....
121507	21844	Finger Guard.....
120858	21844	" " Holder with 50302J.....
50302J	21844	" " " Set Screw.....
236J	21844	" " Screw.....
121562	21844	Finger Guard (wire) complete, Nos. 120858 121507 and two 236J.....

FITTINGS FOR DRESS SHIRTS

FOR BUTTON STAYS

No.	Plate	Name
26603	21847	Feed Dog, 20 teeth (16 teeth to the inch) for 26605 and 26606.....
121653	21847	Hemmer on Shank for 9/16 in. hem.....
7298	21847	Presser Foot Hinge Pin.....
120143	-----	" " Plate.....
19335	-----	" " Shank.....
120144	21847	Presser Foot (hinged) complete, Nos. 7298, 19335 and 120143.....
26605	21847	Throat Plate (large needle hole) for 26603.....
26606	-----	Throat Plate (small needle hole) for 26603.....

FOR COLLAR WORK

(FIRST STITCHING)

No.	Plate	Name
20164	21845	Feed Dog, 16 teeth (16 teeth to the inch) for 1/8 in. stitch (1/64 in. higher) for 52190.....
52189	21845	Presser Foot (solid) for 52190.....
52190	21845	Throat Plate for 20164.....

**FOR COLLAR WORK
(SECOND STITCHING)**

No.	Plate	Name
121646	21848	Feed Dog, 12 teeth (16 teeth to the inch) for 121649.....
121647	21848	Presser Foot with 121646 and two 337J, for 3/16 in., 7/32 in., 9/32 in. and 5/16 in. gauges.....
121648	21848	Presser Foot Edge Guide, for 3/16 in., 7/32 in., 1/4 in., 9/32 in. and 5/16 in. gauges, for 121647.....
337J	21848	Presser Foot Edge Guide Screw.....
121649	21848	Throat Plate for 121646.....

FOR CUFF WORK

No.	Plate	Name
20164	21846	Feed Dog, 16 teeth (16 teeth to the inch) for 1/8 in. stitch (1/64 in. higher) for 52190.....
52188	21846	Presser Foot (solid) for 52190.....
52190	21846	Throat Plate for 20164.....

SLEEVE PLACKETS (Facing)

No.	Plate	Name
121655	21849	Binder on Shank.....
26603	21849	Feed Dog, 20 teeth (16 teeth to the inch) for 26605 and 26606.....
121656	21849	Presser Foot.....
26605	21849	Throat Plate (large needle hole) for 26603.....
26606	-----	Throat Plate (small needle hole) for 26603.....

FOR SHOULDER JOINING

No.	Plate	Name
26603	21850	Feed Dog, 20 teeth (16 teeth to the inch) for 26605 and 26606.....
121662	21850	Joining Attachment for 121663.....
121663	21850	Presser Foot for 121662.....
26605	21850	Throat Plate (large needle hole) for 26603.....
26606	-----	" " (small needle hole) for 26603.....

FOR YOKING

No.	Plate	Name
121658	21851	Edge Folder with Edge Guide on Shank, for 121660.....
26603	21851	Feed Dog, 20 teeth (16 teeth to the inch) for 26605 and 26606.....
7298	21851	Presser Foot Hinge Pin.....
121659	-----	" " Plate.....
19223	-----	" " Shank.....
121660	21851	Presser Foot (hinged) complete for 121658 Nos. 7298, 19223 and 121659.....
26605	21851	Throat Plate (large needle hole) for 26603.....
26606	-----	Throat Plate (small needle hole) for 26603.....

FOOT LIFTER PARTS

No.	Plate	Name
5596	22226	Bell Crank.....
56848	-----	" " 5596 with 5599 and 5601.....
5599	22226	" " Bracket.....
178E	22230	" " Screw.....
5601	22230	" " Hinge Pin.....
5735	21844	" " Spring.....
5598	22226	Bell Crank complete, Nos. 5735 and 56848.
5670	-----	Chain, length 26 in. to 35 in., with 56864 and 56865.....

Note: When ordering No. 5670, state length required.

4879	21844	Chain Connecting Link.....
56864	21819	" Hook (large).....
56865	21819	" " (small).....
16510	21838	Lifting Lever with 448C.....
52028	22226	" " Connecting Rod.....
12416	5936	" " " " Joint.....
76D	22230	" " " " Hinge Screw.....
1521J	22230	Lifting Lever Connecting Rod Lock Nut....
802D	22230	" " Hinge Screw.....
12241	5936	" " Link.....
766D	22230	" " Hinge Screw.....
12240	22230	" " Pin.....
448C	22218	" " " Set Screw.....
2763	5876	Rock Shaft.....
12242	5876	" " Hanger with two wood screws 1 in. No. 10.....

FOOT LIFTER PARTS

No.	Plate	Name
6337	5876	Rock Shaft Lifting Bracket with two 356C.
12243	5876	" " " " Hook.....
7125	5876	" " " " Hook.....
356C	22230	" " " " Set Screw
356C	22230	" " " " Set Screw.....
2770	5876	" " Stop Dog with 356C.....
356C	22230	" " " " Set Screw.....
4880	5876	Rock Shaft complete, Nos. 2763, 2770, 7125 12243 and two each 6337 and 12242....
4881	5876	Treadle.....
4882	22230	" Shaft.....
4883	22230	" Spring.....
4884	5876	" Stand.....
4885	5876	Treadle complete, Nos. 4879, 4881 to 4884 and two wood screws 1 in. No. 16.....
52029	-----	Foot Lifter complete, Nos. 76D, 766D, 802D 1521J, 4880, 4885, 5598, 5670, 12240, 12241, 12416, 16510, 52028 and two 178E.....

HEMMERS (Foot)

No.	Plate	Name
120938	5921	Hemmer (foot) for 3/32 in. hem.....
120803	5919	" " " 1/8 in. hem.....
120804	5919	" " " 5/32 in. hem.....
120805	5919	" " " 3/16 in. hem.....
36122	-----	" " " 7/32 in. hem.....
120806	5920	" " " 1/4 in. hem.....
120807	5920	" " " 5/16 in. hem.....
6267	-----	" Folder for 36122.....
120939	5919	" " " 120803 to 120807 and 120938.....
*25886	-----	Hemmer Tongue for 36122.....
*120838	5919	" " " 120804 and 120805.....
*120839	21844	" " " 120806 and 120807.....
*120843	5919	" " " 120803 and 120938.....

Note: When ordering Hemmer **Folders** or Hemmer
Tongues, state width of hem and No. of hemmer
for which it is required.

35710	-----	Hemmer (foot) 3/32 in. hem, with guide on bottom to the right of needle hole...
35682	21817	Hemmer (foot) 1/8 in. hem, with guide on bottom to the right of needle hole...
36524	-----	Hemmer (foot) 5/32 in. hem, with guide on bottom to the right of needle hole...

HEMMERS (Foot)

No.	Plate	Name
35997	-----	Hemmer (foot) 3/16 in. hem, with guide on bottom to the right of needle hole...
36309	-----	Hemmer (foot) 7/32 in. hem, with guide on bottom to the right of needle hole...
36072	-----	Hemmer (foot) 1/4 in. hem, with guide on bottom to the right of needle hole...
120898	5921	Hemmer (foot) for 1/16 in. to 1/8 in. hem for China Silk, etc.....
120911	5921	Hemmer (foot) for 5/32 in. to 1/4 in. hem for China Silk, etc.....
36413	-----	Hemmer (foot) plain bottom, 1/16 in. hem.
36414	-----	" " " " 3/32 in. hem.
36480	-----	" " " " 5/32 in. hem.
36416	-----	" " " " 3/16 in. hem.
120837	5920	" " " " 1/8 in. hem, slotted for lace.....

HEMMERS ON SHANK

No.	Plate	Name
20163	5882	Feed Dog, for 1/16 in. stitch, 16 teeth (16 teeth to the inch) for 20123 and 35540.....
35926	-----	Hemmer.....
590J	21844	" Adjusting Screw.....
1443B	21844	" Screw.....
35927	-----	" Shank.....
35540	5882	Hemmer on Shank complete, with right hand lower guide, for lace, Nos. 1443B, 35926, 35927 and two 590J.....
62527	21839	Presser Foot Hinge Pin.....
40316	-----	" " Plate.....
40317	-----	" " Shank.....
40318	5882	Presser Foot (hinged) complete, for lace running, for 35540, Nos. 40316, 40317 and 62527.....
20123	5882	Throat Plate for 20163 and 35540.....
26603	21818	Feed Dog, 20 teeth (16 teeth to the inch) for 26605, 26606 and 35236.....
35236	1971	Hemmer on Shank, for 7/16 in. hem.....
52055	21819	Presser Foot for 35236.....
26605	21818	Throat Plate, large needle hole, for 26603.....
26606	-----	Throat Plate, small needle hole, for 26603.....

HEMMERS ON SHANK

No.	Plate	Name
26603	21852	Feed Dog, 20 teeth (16 teeth to the inch) for 26605 and 26606.....
120991	21852	Hemmer on Shank, for 1/16 in. to 1/4 in. gauges.....
28627	21852	Hemmer on Shank, for 1/8 in. to 5/8 in. gauges, for 28628.....
28628	21852	Presser Foot, for 3/8 in. to 5/8 in. gauges, for 28627.....
26605	21852	Throat Plate (large needle hole) for 26603.....
26606	-----	Throat Plate (small needle hole) for 26603.....

FOR HEMMING SHEETS

No.	Plate	Name
52031	21853	Feed Dog, 19 teeth (22 teeth to the inch) for 52032 and 52033.....
1499J	21853	Hemmer Screw.....
121672	21853	" on Shank.....
121673	21853	" Throw-out Arm with 35522.....
35522	21853	" " " Pin.....
121674	21853	Hemmer complete on Throw-out Arm, for 2 in. or 3 in. hem, Nos. 121672, 121673 and two 1499J.....

Note: When ordering No. 121674, state width of hem.

1499J	21853	Hemmer Screw.....
121675	21853	" on Shank.....
121676	21853	" Throw-out Arm with 35522.....
35522	21853	" " " Pin.....
121677	21853	Hemmer complete on Throw-out Arm, for 1 in. hem, Nos. 121675, 121676 and two 1499J.....
121678	21853	Hemmer Tension Spring.....
121679	-----	Hemmers complete, for 1 in. and 2 in. or 3 in. hems, Nos. 24J, 39026, 121674, 121677 and 121678.....

Note: When ordering No. 121679, state width of hems

24J	21853	Hemmers Hinge Screw.....
39026	21853	" " " Washer.....
121680	21853	Presser Foot.....
52032	21853	Throat Plate (large needle hole) for 52031.....
52033	-----	Throat Plate (small needle hole) for 52031.....

HEMMERS ON SHANK

FOR HEMMING PILLOW CASES

No.	Plate	Name
26603	21854	Feed Dog, 20 teeth (16 teeth to the inch) for 26605 and 26606.....
121665	21854	Hemmer Scroll (lower) on Shank with 337B, 36696 and 121667, for 121668.....
121667	21854	Hemmer Scroll (lower) Spring with 43525..
36696	21854	" " " " Lock Pin....
43525	21854	" " " " Position Pin
337B	21854	" " " " " Screw
121666	21854	" " (upper).....
121668	21854	Hemmer on Shank complete, for 7/8 in. to 2 in. hem, Nos. 121665 and 121666....
121669	21854	Hemmer Scroll (lower) on Shank with 337B, 36696 and 121667, for 121671.....
121667	21854	Hemmer Scroll (lower) Spring with 43525..
36696	21854	" " " " Lock Pin....
43525	21854	" " " " Position Pin
337B	21854	" " " " " Screw
121670	21854	" " (upper).....
121671	21854	Hemmer on Shank complete, for 2-1/16 in. to 4 in. hem, Nos. 121669 and 121670.
35063	21854	Presser Foot.....
26605	21854	Throat Plate (large needle hole) for 26603.....
26606	-----	Throat Plate (small needle hole) for 26603.....

KNEE LIFTER PARTS

No.	Plate	Name
5596	22226	Bell Crank.....
56848	-----	" " 5596 with 5599 and 5601.....
5599	22226	" " Bracket.....
178E	22230	" " " Screw.....
5601	22230	" " Hinge Pin.....
5735	21844	" " Spring.....
5598	22226	Bell Crank complete, Nos. 5735 and 56848.
16510	21838	Lifting Lever with 448C.....
52028	22226	" " Connecting Rod.....
12416	5936	" " " " Joint.....
76D	22230	" " " " " Hinge Screw.....
1521J	22230	Lifting Lever Connecting Rod Lock Nut....
802D	22230	" " Hinge Screw.....

KNEE LIFTER PARTS

No.	Plate	Name
12241	5936	Lifting Lever Link.....
766D	22230	" " " Hinge Screw.....
12240	22230	" " Pin.....
448C	22218	" " " Set Screw.....
2759	5877	" Rod with 2761.....
2761	21844	" " Cap (washer).....
2762	21844	" " Collar with 362C.....
362C	21844	" " " Set Screw.....
2760	-----	Lifting Rod complete, Nos. 2759 and 2762.
2763	5877	Rock Shaft.....
12242	5876	" " Hanger with two wood screws 1 in. No. 10.....
2765	5877	Rock Shaft Knee Arm for 2768.....
6335	5877	" " " " 6336.....
2766	5877	" " " " Hub with 356C.....
356C	22230	" " " " Set Screw.....
2768	-----	Rock Shaft Knee Arm complete for 2777, Nos. 2765 to 2767.....
6336	-----	Rock Shaft Knee Arm complete for 19168, Nos. 2766, 2767 and 6335.....
2767	5877	Rock Shaft Knee Plate with 356C.....
356C	22230	" " " " Set Screw.....
2769	5877	" " Lifting Arm with 356C.....
356C	22230	" " " " Set Screw.....
6337	5877	" " " " Bracket with two 356C.....
2778	5877	" " " " Hook.....
356C	22230	" " " " Set Screw.....
356C	22230	" " " " Set Screw.....
2770	5876	" " Stop Dog with 356C.....
356C	22230	" " " " Set Screw.....
2777	5877	Rock Shaft complete for 52030, Nos. 2763, 2768, 2770, 2778, 6337 and two 12242.....
19168	-----	Rock Shaft complete for 52038, Nos. 2760, 2763, 2769, 6336 and two each 2770 and 12242.....
52030	-----	Knee Lifter complete (power table) Nos. 76D, 766D, 802D, 1521J, 2777, 5598, 12240, 12241, 12416, 16510, 52028 and two 178E.....
52038	-----	Knee Lifter complete (bench stand) Nos. 76D, 766D, 802D, 1521J, 5598, 12240, 12241, 12416, 16510, 19168, 52028 and two 178E.....

MACHINE BASE

No.	Plate	Name
24106	21843	Bed Frame Cushion (felt).....
158E	22218	" " " Screw.....
24107	21843	" " Hinge Connection.....
9261	21843	" " " Pin.....
970D	21843	" " Thumb Screw.....
24108	5876	Bed Frame complete, Nos. 970D, two each 9261, 24107, four each 158E, 24106 and six wood screws 1-1/4 in. No. 12.

PIPING ATTACHMENT

No.	Plate	Name
120977	-----	Piping Attachment.....
1443J	21844	" " " Screw.....
35245	21817	Piping Attachment complete, for piping house dresses, Nos. 1443J and 120977.
44253	22228	Feed Dog, 16 teeth (16 teeth to the inch) for 44255 and 44256.....
52056	21817	Presser Foot.....
44256	22228	Throat Plate, large needle hole, for 44253.....
44255	-----	Throat Plate, small needle hole, for 44253.....

PRESSER FEET

No.	Plate	Name
36464	21817	Presser Foot Spring Guide.....
665J	21817	" " " " Screw.....
36465	21817	Presser Foot (right hand spring guide) with 665J and 36464, for 1/32 in. to 5/16 in. gauges.....
Note: When ordering No. 36464 or No. 36465, state required distance from edge of goods to seam.		
36574	22228	Presser Foot.....
36575	-----	" " 36574 with 36576 and two 50202J.....
36576	22228	Presser Foot Finger Guard.....
50202J	22228	" " " " Screw.....
36714	-----	" " with 233J.....
36715	21817	" " Guide (right) with 36716....
233J	21817	" " " Set Screw.....

PRESSER FEET

No.	Plate	Name
36716	21817	Presser Foot Guide Stud.....
36717	21817	Presser Foot complete with Adjustable Guide (right) Nos. 36714 and 36715...
36773	21819	Presser Foot, for braiding.....
120828	21839	" " (single toe) for gathering, for fine work.....

RUFFLER

No.	Plate	Name
121116	22229	Driving Lever.....
51371K	21844	" " Adjusting Thumb Screw (lower)
560B	21844	" " " " " (upper)
120812	22228	" " Bushing.....
120813	22228	" " Friction Washer.....
51219F	21844	" " Hinge Screw.....
1700J	22228	" " " " Nut.....
121117	22229	Frame.....
36637	22228	" Spring Plate.....
36638	22228	Ribbon Guide.....
240B	22228	" " Screw.....
121118	22228	Ruffling Blade.....
121119	22228	" " Holder.....
121120	-----	" " " 121119 with 121118 and two 120829.....
36641	22228	Ruffling Blade Holder Guide.....
36642	22228	" " " " Rivet.....
51221F	22228	" " " " Hinge Screw.....
1772J	22228	" " " " Nut....
121121	22229	" " Lever with 560B and 51371K
120829	22228	" " Rivet.....
36644	22228	Separating Blade.....
120830	-----	" " Holder.....
121501	-----	" " " 120830 with 36644 and two 120829.....
36646	22228	Separating Blade Holder Friction Spring..
36647	22228	" " " " Hinge Stud.....
36648	22228	" " " " Stop Stud.....
120829	22228	" " Rivet.....
36644	22228	Shirring Blade.....
120818	-----	" " Holder.....
120819	-----	" " " 120818 with 36644 and two 120829.....
120829	22228	Shirring Blade Rivet.....

RUFFLER

No.	Plate	Name
121123	22229	Ruffler complete, Nos. 240B, 1700J, 1772J 36637, 36638, 36641, 36642, 36646 to 36648, 51219F, 51221F, 120812, 120813 121116, 121117, 121120, 121121 and 121501.....
121451	-----	Ruffler 121123 with 1981, 51272C and 120819.....
1981	21844	Ruffler Roller.....
51272C	21844	" " Stud and Needle Clamping Screw.....

THREAD UNWINDER

FOR TWO SPOOLS OR TWO LARGE CONES OF THREAD

No.	Plate	Name
225257	20335	Spool Rest with 201018C.....
150203	20335	" " Cushion (felt).....
225388	20335	" " Rod.....
200383C	22230	" " " Set Screw.....
201018C	22230	" " Set Screw.....
202490	20335	" Stand with 200383C.....
225391	20335	Thread Guide.....
201696J	22230	" " Lock Nut.....
225326	20335	" " Position Cup.....
225324	20335	" " Rod with 208E and 225322.....
208E	22230	" " " Screw.....
225322	22230	" " " Washer.....
225258	20335	Thread Unwinder complete, Nos. 201696J, 202490, 225257, 225324, 225326, 225388 two each 150203, 225391 and three wood screws 7/8 in. No. 12 F.H.....
27739	7234	Thread Cone (wood) for large cones.....
225390	7234	" " Holder, for inverted cones...

Note: Nos. 27739 and 225390 are used with, but not included in 225258.

TUCKERS (Long Arm)

No.	Plate	Name
36387	5884	Space Guide.....
35510	5884	" " Base with 35512, 35514 and two 1426E.....
402J	5885	Space Guide Base Screw.....
35511	5885	" " Indicator.....

TUCKERS (Long Arm)

No.	Plate	Name
35512	5885	Space Guide Pin.....
35513	5885	" " Stop (left).....
35514	5885	" " " " Guide Pin.....
1426E	5885	" " " " Screw Stud.....
1657D	5885	" " " " Thumb Nut.....
17718	5885	" " " " " Washer..
35515	5885	" " " " (right).....
1426E	5885	" " " " Screw Stud.....
1657D	5885	" " " " Thumb Nut.....
17718	5885	" " " " " Washer...
287J	5885	" " " " Thumb Screw.....
36388	-----	Space Guide complete, Nos. 287J, 35510, 35511, 35513, 35515, 36387 and two each 1657D and 17718.....
35517	5883	Tuck Guide Arm.....
1177J	5885	" " " " Screw.....
35518	5883	" " " " Base.....
50134E	5885	" " " " Screw Stud.....
36389	5883	" " " " Bracket.....
307C	5885	" " " " Screw Center.....
56814	-----	" " " " " 307C with 1513J.....
1513J	5885	Tuck Guide Bracket Screw Center Nut.....
36390	5885	" " " " Spring.....
36391	5884	" " " " Plate.....
9D	5885	" " " " Screw.....
423C	22218	" " " " Stop Screw.....
1520J	5936	" " " " " Nut.....
36392	5883	" " " " Frame.....
36393	5885	" " " " Spring.....
1510E	5885	" " " " Nut.....
35524	5885	" " " " Washer.....
803C	5885	" " " " Stop Screw.....
1520J	5936	" " " " " Nut.....
35511	5885	" " " " Indicator.....
35525	5883	" " " " Plate.....
1115F	5885	" " " " Screw.....
36394	-----	Tuck Guide complete, Nos. 9D, 423C, 803C, 1510E, 35511, 35517, 35518, 35524, 35525, 36389 to 36393, 50134E, two each 1115F, 1177J, 1520J, 56814 and three wood screws 1-1/4 in. No. 10...
36395	-----	Tucker (long arm) complete, Nos. 35528, 36388, 36394 and two 402J.....
52031	21839	Feed Dog, for shirt work, 19 teeth (22 teeth to the inch) for 52032 and 52033.....
35528	21839	Presser Foot (wide) for 36395.....
40322	21839	" " (narrow) for 36395.....

TUCKERS (Long Arm)

No.	Plate	Name
36654	21839	Presser Foot for tucking shirt bosoms, for 36670.....
52032	21853	Throat Plate, large needle hole, for 52031.....
52033	21839	Throat Plate, small needle hole, for 52031.....
36670	-----	Tucker (long arm) complete, for tango tucking, Nos. 36388, 36394, 36654 and two 402J.....

Genuine Singer Needles should be used
in Singer Machines.
These Needles and their Containers
are marked with the
Company's Trade Mark "SIMANCO." 1

Needles in Containers marked
"For Singer Machines"
are not Singer made needles. 2

NUMERICAL LIST OF PARTS

No.	Plate	Name
9D	5885	Tucker (long arm) Tuck Guide Bracket Spring Screw, for 36394.....
24J	21853	Hemmers Hinge Screw, for 121679.....
76D	22230	Lifting Lever Connecting Rod Joint Hinge Screw, for 52029, 52030 and 52038....
116E	21836	Arm Screw (back).....
144D	22218	" Shaft (horizontal) Screw.....
152F	2834	Bobbin Winder Stop Latch Finger Screw, for 60456.....
157J	22220	Feed Lifting Rock Shaft Crank Clamping Screw, for 52265.....
157J	22220	Feed Rock Shaft Crank Clamping Screw, for 29633.....
158J	22218	Arm Top Cover Screw.....
158E	22218	Bed Frame Cushion Screw, for 24108.....
158J	22218	Bobbin Winder Tension Bracket Screw.....
171J	21843	" " Pulley Set Screw, for 41585
176J	22220	Face Plate Screw.....
176J	22220	Presser Foot Screw.....
178E	22230	Bell Crank Bracket Screw, for 52029, 52030 and 52038.....
185H	21843	Bobbin Winder Stop Latch Tripping Arm Clamping Screw, for 41588.....
196J	21844	Finger Guard Holder Set Screw, for 36820.
200F	2834	Bobbin Winder Pulley Set Screw, for 41342.
207J	2834	" " Frame Spring Screw, for 60456.....
207E	2834	Needle Bar Connecting Stud Clamping Screw for 24041.....
208E	22230	Thread Unwinder Thread Guide Rod Screw, for 225324.....
219J	22218	Arm Shaft (horizontal) Ball Bearing (back) Cover Screw, for 95-100 Machine
219J	22218	Arm Side Cap Screw.....
223C	5936	Slack Thread Regulator Set Screw, for 52338.....
226J	22220	Face Plate Thread Guard (lower) Screw, for 52052.....
226J	22220	Face Plate Thread Guard (upper) Screw, for 52052.....
233J	21817	Presser Foot Guide Set Screw, for 36714..
236J	21844	Finger Guard Screw, for 121562.....
240B	22228	Ruffler Ribbon Guide Screw, for 121123...
287J	5885	Tucker (long arm) Space Guide Thumb Screw for 36388.....

Genuine Singer Needles should be used
 in Singer Machines.
 These Needles and their Containers
 are marked with the
 Company's Trade Mark "SIMANCO." 1

Needles in Containers marked
 "For Singer Machines"
 are not Singer made needles. 2

NUMERICAL LIST OF PARTS

No.	Plate	Name
307C	5885	Tucker (long arm) Tuck Guide Bracket Screw Center, for 56814.....
313C	22220	Feed Bar Screw Center, for 56813.....
337B	21848	Hemmer Scroll (lower) Spring Position Screw, for 121665 and 121669.....
337J	21848	Presser Foot Edge Guide Screw, for 121647.
356C	22230	Rock Shaft Knee Arm Hub Set Screw, for 2766.....
356C	22230	Rock Shaft Knee Plate Set Screw, for 2767
356C	22230	" " Lifting Arm Set Screw, for 2769
356C	22230	" " " Bracket Hook Set Screw for 6337.....
356C	22230	Rock Shaft Lifting Bracket Set Screw, for 6337.....
356C	22230	Rock Shaft Stop Dog Set Screw, for 2770..
362C	21844	Lifting Rod Collar Set Screw, for 2762...
375C	22220	Feed Connecting Link Hinge Screw.....
375C	22220	" Forked Connection Hinge Screw, for 52085.....
375C	22220	Feed Lifting Rock Shaft Connecting Rod Hinge Screw.....
401E	21842	Arm Shaft (horizontal) Ball Bearing (front) Cover Screw, for 52214.....
402J	5885	Tucker (long arm) Space Guide Base Screw, for 36395 and 36670.....
418E	2834	Bobbin Winder Tension Screw Stud, for 27308.....
423C	22218	Arm Shaft (horizontal) Intermediate Bushing Set Screw.....
423C	22218	Tucker (long arm) Tuck Guide Bracket Stop Screw, for 36394.....
432C	22218	Arm Shaft (upright) Bushing (lower) Set Screw.....
435C	22218	Arm Shaft (horizontal) Flanged Bushing (front) Set Screw.....
435C	22218	Thread Take-up Lever Link Hinge Pin Set Screw.....
443C	22218	Arm Shaft (upright) Bushing (upper) Set Screw.....
446C	21842	Arm Shaft (horizontal) Ball Bearing (back) Locking Pin Cone Screw, for 95-100 Machine.....
448C	22218	Arm Shaft (horizontal) Flanged Bushing (back) Set Screw.....
448C	22218	Balance Wheel Set Screw, for 52176.....
448C	22218	Feed and Feed Lifting Eccentric Set Screw for 52218.....
448C	22218	Lifting Lever Pin Set Screw, for 16510...
448C	22218	Thread Take-up Spring Regulator Set Screw

NUMERICAL LIST OF PARTS

No.	Plate	Name
453C	5936	Presser Bar Guide Bracket Set Screw, for 52338.....
457C	21843	Bobbin Winder Frame Hinge Pin Set Screw, for 41583.....
457C	21843	Bobbin Winder Stop Latch Hinge Stud Set Screw, for 41913.....
460C	21843	Bobbin Winder Tension Stud Set Screw, for 150459.....
560B	21844	Ruffler Driving Lever Adjusting Thumb Screw (upper) for 121121.....
590J	21844	Hemmer Adjusting Screw, for 35540.....
591F	22224	Rotating Hook Bobbin Case Tension Regulating Screw, for 52236.....
592E	22224	Rotating Hook Bobbin Case Latch Stop Screw, for 52237.....
624C	22224	Thread Retainer Set Screw.....
665J	21817	Presser Foot Spring Guide Screw, for 36465
686W	21840	Pressure Regulating Thumb Screw.....
689C	5936	Presser Bar Lifter Hinge Screw.....
691F	21839	Throat Plate Screw.....
704J	22224	Rotating Hook Bobbin Case Holder Position Bracket Screw.....
725J	22220	Bed Slide Spring Screw, for 12432.....
766D	22230	Lifting Lever Link Hinge Screw, for 52029 52030 and 52036.....
775E	21840	Needle Bar Connecting Link Cap Screw, for 52270.....
802D	22230	Lifting Lever Hinge Screw, for 52029, 52030 and 52036.....
803C	5885	Tucker (long arm) Tuck Guide Frame Stop Screw, for 36394.....
818D	21840	Feed Regulator Thumb Screw, for 52093....
857H	21840	Needle Set Screw, for 52155.....
868E	21836	Arm Screw (front).....
880E	21843	Bobbin Winder Screw, for 41915.....
966E	22220	Feed Lifting Rock Shaft Connecting Rod Cap Set Screw, for 127156.....
970D	21843	Bed Frame Thumb Screw, for 24108.....
1036C	22218	Arm Shaft (horizontal) Bevel Gear Set Screw, for 127072.....
1036C	22218	Thread Take-up Crank Set Screw, for 52246 and 52247.....
1037C	21842	Thread Take-up Crank Position Screw, for 52246 and 52247.....
1053E	22224	Rotating Hook Thread Guard Screw, for 127096.....
1065C	21840	Needle Bar Crank Position Screw, for 52246 and 52247.....
1115F	5885	Tucker (long arm) Tuck Guide Screw, for 36394.....

NUMERICAL LIST OF PARTS

No.	Plate	Name
1128E	21840	Feed Regulator Hinge Screw.....
1133E	21840	Needle Bar Bushing (lower) Set Screw.....
1133E	21840	" " " (upper) Set Screw.....
1148C	22224	Rotating Hook Shaft Bushing (back) Set Screw.....
1148C	22224	Rotating Hook Shaft Bushing (front) Set Screw.....
1177J	5885	Tucker (long arm) Tuck Guide Arm Screw, for 36394.....
1253C	22224	Rotating Hook Set Screw, for 127095.....
1259C	22218	Arm Shaft (upright) Bevel Gear (lower) Set Screw, for 52281.....
1259C	22218	Arm Shaft (upright) Bevel Gear (upper) Set Screw, for 52282.....
1259C	22218	Rotating Hook Shaft Bevel Gear Set Screw, for 127073.....
1299C	22220	Feed and Feed Lifting Eccentric Position Screw, for 52218.....
1367E	22224	Rotating Hook Section Screw, for 127097 and 127239.....
1380E	22224	Rotating Hook Bobbin Case Tension Spring Screw, for 52236.....
1426E	5885	Tucker (long arm) Space Guide Stop (left) Screw Stud, for 35510.....
1426E	5885	Tucker (long arm) Space Guide Stop (right) Screw Stud, for 35510.....
1429D	2834	Bobbin Winder Frame Hinge Screw, for 60456
1430D	2834	" " Stop Latch Hinge Screw, for 60456.....
1430D	2834	Bobbin Winder Stop Latch Lever Hinge Screw, for 60456.....
1443B	21844	Hemmer Screw, for 35540.....
1443J	21844	Piping Attachment Screw, for 35245.....
1499J	21853	Hemmer Screw, for 121674 and 121677.....
1510E	5885	Tucker (long arm) Tuck Guide Frame Spring Nut, for 36394.....
1513J	5885	Feed Lifting Rock Shaft Screw Center Nut, for 52097.....
1513J	5885	Feed Rock Shaft Screw Center Nut, for 52097.....
1513J	5885	Tucker (long arm) Tuck Guide Bracket Screw Center Nut, for 56814.....
1518J	22220	Feed Connecting Link Hinge Screw Nut.....
1518J	22220	" Forked Connection Hinge Screw Nut, for 52085.....
1518J	22220	Feed Lifting Rock Shaft Connecting Rod Hinge Screw Nut.....
1519J	22220	Feed Bar Screw Center Nut, for 56813.....
1520J	5936	Presser Bar Lifter Hinge Screw Nut.....

NUMERICAL LIST OF PARTS

No.	Plate	Name
1520J	5936	Tucker (long arm) Tuck Guide Bracket Stop Screw Nut, for 36394.....
1520J	5936	Tucker (long arm) Tuck Guide Frame Stop Screw Nut, for 36394.....
1521J	22230	Lifting Lever Connecting Rod Lock Nut, for 52029, 52030 and 52038.....
1550H	2834	Bobbin Winder Stop Latch Hinge Screw Nut, for 60456.....
1560C	22224	Tension Regulating Thumb Nut, for 52098..
1562J	2834	Bobbin Winder Tension Regulating Thumb Nut, for 27308.....
1657D	5885	Tucker (long arm) Space Guide Stop (left) Thumb Nut, for 36388.....
1657D	5885	Tucker (long arm) Space Guide Stop (right) Thumb Nut, for 36388.....
1700J	22228	Ruffler Driving Lever Hinge Screw Nut, for 121123.....
1772J	22228	Ruffler Ruffling Blade Holder Hinge Screw Nut, for 121123.....
1981	21844	Ruffler Roller, for 121451.....
2102	3471	Bobbin Winder Tension Disc, for 225462...
2102	3471	Tension Disc, for 52092.....
2106	2834	Bobbin Winder Tension Thread Guide, for 27308.....
2455	2834	Bobbin Winder Tension Disc, for 27308 and 150460.....
2759	5877	Lifting Rod with 2761, for 2760.....
2760	-----	Lifting Rod complete for 19168, Nos. 2759 and 2762.....
2761	21844	Lifting Rod Cap (washer) for 2759.....
2762	21844	" " Collar with 362C, for 2760...
2763	5877	Rock Shaft, for 2777.....
2763	5876	" " " 4880 and 19168.....
2765	5877	" " Knee Arm, for 2768.....
2766	5877	" " " Hub with 356C, for 2768 and 6336.....
2767	5877	Rock Shaft Knee Plate with 356C, for 2768 and 6336.....
2768	-----	Rock Shaft Knee Arm complete for 2777, Nos. 2765 to 2767.....
2769	5877	Rock Shaft Lifting Arm with 356C, for 19168.....
2770	5876	Rock Shaft Stop Dog with 356C, for 2777, 4880 and 19168.....
2777	5877	Rock Shaft complete for 52030, Nos. 2763, 2768, 2770, 2778, 6337 and two 12242.
2778	5877	Rock Shaft Lifting Bracket Hook, for 2777.
2974	22224	Rotating Hook Bobbin Case Latch Lever Fulcrum Pin, for 40393.....

NUMERICAL LIST OF PARTS

No.	Plate	Name
2975	21840	Rotating Hook Bobbin Case Latch Spring, for 52237.....
3146	21843	Binder Thumb Screw Washer, for 121168....
4307	22220	Bed Slide Spring, for 12432.....
4879	21844	Chain Connecting Link, for 4885.....
4880	5876	Rock Shaft complete for 52029, Nos. 2763, 2770, 7125, 12243 and two each 6337 and 12242.....
4881	5876	Treadle, for 4885.....
4882	22230	" Shaft, for 4885.....
4883	22230	" Spring, for 4885.....
4884	5876	" Stand, for 4885.....
4885	5876	Treadle complete for 52029, Nos. 4879, 4881 to 4884 and two wood screws 1 in. No. 16.....
5596	22226	Bell Crank, for 56848.....
5598	22226	Bell Crank complete for 52029, 52030 and 52038, Nos. 5735 and 56848.....
5599	22226	Bell Crank Bracket, for 56848.....
5601	22230	" " Hinge Pin, for 56848.....
5670	-----	Chain, length 26 in. to 35 in. with 56864 and 56865, for 52029.....
5735	21844	Bell Crank Spring, for 5598.....
6267	-----	Hemmer Folder, for 36122.....
6335	5877	Rock Shaft Knee Arm, for 6336.....
6336	-----	Rock Shaft Knee Arm complete for 19168, Nos. 2766, 2767 and 6335.....
6337	5877	Rock Shaft Lifting Bracket with two 356C, for 2777.....
6337	5876	Rock Shaft Lifting Bracket with two 356C, for 4880.....
7125	5876	Rock Shaft Lifting Bracket Hook, for 4880.
7298	21847	Presser Foot Hinge Pin, for 120144 and 121660.....
7958	21843	Bobbin Winder Stop Latch Stop Pin, for 60845.....
8879	5936	Arm Spool Pin Washer (cloth).....
8879	5936	Bobbin Winder Tension Bracket Spool Pin Washer (cloth).....
8879	5936	Tape Reel Washer (cloth) for 121412.....
8908	21835	Wrench, for 1519 and 1520 (Accessories)..
8909	21835	" " 1513 and 1518 (Accessories)..
9261	21843	Bed Frame Hinge Connection Pin, for 24108.
9331	2834	Bobbin Winder Washer, for 41347.....
10141	2834	" " Tension Spring, for 27308..
11170	5936	Presser Bar Spring Washer.....
11204	21842	Thread Take-up Lever Link Hinge Pin, for 52269.....
11241	2833	Bobbin Winder Spool Washer (cloth) for 27308.....

NUMERICAL LIST OF PARTS

No.	Plate	Name
11656	21819	Tape Reel Arm Steady Pin, for 121412.....
12240	22230	Lifting Lever Pin, for 52029, 52030 and 52038.....
12241	5936	Lifting Lever Link, for 52029, 52030 and 52038.....
12242	5876	Rock Shaft Hanger with two wood screws 1 in. No. 10, for 2777, 4880 and 19168.
12243	5876	Rock Shaft Lifting Bracket Hook, for 4880
12327	5936	Presser Bar Lifting and Releasing Lever Bracket.....
12329	5936	Tension Releasing Lever Spring.....
12361	21843	Machine Hinge Connection, for 44140.....
12391	21841	Presser Bar (hollow).....
12398	5936	Tension Releasing Lever Hinge Pin.....
12416	5936	Lifting Lever Connecting Rod Joint, for 52029, 52030 and 52038.....
12431	-----	Bed Slide, for 12432.....
12432	21806	Bed Slide complete, Nos. 4307, 12431 and two 725J.....
13710	21842	Tension Spring, for 52092.....
*15404	-----	Trade Mark, for 52252 and 52253.....
15405	-----	" " Rivet, for 52252 and 52253....
16510	21838	Lifting Lever with 448C, for 52029, 52030 and 52038.....
16532	21836	Arm Dowel Pin.....
17718	5885	Tucker (long arm) Space Guide Stop (left) Thumb Nut Washer, for 36388.....
17718	5885	Tucker (long arm) Space Guide Stop (right) Thumb Nut Washer, for 36388..
19168	-----	Rock Shaft complete for 52038, Nos. 2760, 2763, 2769, 6336 and two each 2770 and 12242.....
19223	-----	Presser Foot Shank, for 121660.....
19335	-----	" " " " 120144.....
20022	21843	Machine Cushion (felt) Accessories.....
20123	5882	Throat Plate, for 20163 and 35540.....
20163	5882	Feed Dog, for 1/16 in. stitch, 16 teeth (16 teeth to the inch) for 20123 and 35540.....
20164	21845	Feed Dog, 16 teeth (16 teeth to the inch) for 1/8 in. stitch (1/64 in. higher) for 52190, for Collar and Cuff Work..
24037	21838	Feed Forked Connection, for 52085.....
24041	21840	Needle Bar Connecting Stud with 207E, for 127232.....
24079	5877	Drip Pan.....
24106	21843	Bed Frame Cushion (felt) for 24108.....
24107	21843	" " Hinge Connection, for 24108....

NUMERICAL LIST OF PARTS

No.	Plate	Name
24108	5876	Bed Frame complete, Nos. 970D, two each 9261, 24107, four each 158E, 24106 and six wood screws 1-1/4 in. No. 12.....
24544	-----	Presser Foot Plate, for 24983.....
24982	-----	" " Shank, for 24983.....
24983	21839	Presser Foot (spring hinged) complete, Nos. 24544, 24982, 26231 and 62527...
25446	21843	Bobbin Winder Screw Washer, for 41915....
25878	21841	Guide.....
*25888	-----	Hemmer Tongue, for 36122.....
26026	21835	Screw Driver (large) Accessories.....
26231	21839	Presser Foot Spring, for 24983.....
26485	21835	Screw Driver (small) Accessories.....
26603	21847	Feed Dog, 20 teeth (16 teeth to the inch) for 26605, 26606 and 35236.....
26605	21847	Throat Plate, large needle hole, for 26603
26606	-----	" " small needle hole, for 26603
27306	2834	Bobbin Winder Spool Pin, for 27308.....
27307	2833	" " " Stand, for 27308.....
27308	2833	Bobbin Winder Spool Stand complete for 41348, Nos. 418E, 1562J, 2106, 10141, 11241, 27306, 27307 and two each 2455 and wood screws 1 in. No. 10.....
27739	7234	Thread Unwinder Thread Cone (wood) for large cones, for 225258.....
27878	21843	Machine Cushion Rivet (Accessories).....
28627	21852	Hemmer on Shank, for 1/8 in. to 5/8 in. gauges, for 28628.....
28628	21852	Presser Foot, for 3/8 in. to 5/8 in. gauges, for 28627.....
29633	21840	Feed Rock Shaft Crank with 157J, for 52069
32572	21842	Tension Releasing Disc, for 52092.....
32574	21842	" " Pin, for 52092.....
34105	21834	Bobbin Winder Frame Hinge Pin, for 60845.
35063	21854	Presser Foot.....
35208	1971	Binder on Shank, to turn in both edges, for bias or straight binding, for skirts, wrappers, shirt waists, etc..
35236	1971	Hemmer on Shank, for 7/16 in. hem.....
35245	21817	Piping Attachment complete, for piping house dresses, Nos. 1443J and 120977.
35510	5884	Tucker (long arm) Space Guide Base with 35512, 35514 and two 1426E, for 36388.
35511	5885	Tucker (long arm) Space Guide Indicator, for 36388.....
35511	5885	Tucker (long arm) Tuck Guide Indicator, for 36394.....
35512	5885	Tucker (long arm) Space Guide Pin, for 35510.....

NUMERICAL LIST OF PARTS

No.	Plate	Name
35513	5885	Tucker (long arm) Space Guide Stop (left) for 36388.....
35514	5885	Tucker (long arm) Space Guide Stop (left) Guide Pin, for 35510.....
35515	5885	Tucker (long arm) Space Guide Stop (right) for 36388.....
35517	5883	Tucker (long arm) Tuck Guide Arm, for 36394.....
35518	5883	Tucker (long arm) Tuck Guide Base, for 36394.....
35522	21853	Hemmer Throw-out Arm Pin, for 121673 and 121676.....
35524	5885	Tucker (long arm) Tuck Guide Frame Spring washer, for 36394.....
35525	5883	Tucker (long arm) Tuck Guide Plate, for 36394.....
35528	21839	Presser Foot (wide) for 36395.....
35540	5882	Hemmer on Shank complete, with right hand lower guide, for lace, Nos. 1443B, 35926, 35927 and two 590J.....
35682	21817	Hemmer (foot) 1/8 in. hem, with guide on bottom to the right of needle hole...
35710	-----	Hemmer (foot) 3/32 in. hem, with guide on bottom to the right of needle hole...
35926	-----	Hemmer, for 35540.....
35927	-----	" Shank, for 35540.....
35997	-----	" (foot) 3/16 in. hem, with guide on bottom to the right of needle hole...
36072	-----	Hemmer (foot) 1/4 in. hem, with guide on bottom to the right of needle hole...
36122	-----	Hemmer (foot) for 7/32 in. hem.....
36309	-----	" " 7/32 in. hem, with guide on bottom to the right of needle hole...
36387	5884	Tucker (long arm) Space Guide, for 36388.
36388	-----	Tucker (long arm) Space Guide complete for 36395 and 36670, Nos. 287J, 35510 35511, 35513, 35515, 36387 and two each 1657D and 17718.....
36389	5883	Tucker (long arm) Tuck Guide Bracket, for 36394.....
36390	5885	Tucker (long arm) Tuck Guide Bracket Spring, for 36394.....
36391	5884	Tucker (long arm) Tuck Guide Bracket Spring Plate, for 36394.....
36392	5883	Tucker (long arm) Tuck Guide Frame, for 36394.....
36393	5885	Tucker (long arm) Tuck Guide Frame Spring for 36394.....

NUMERICAL LIST OF PARTS

No.	Plate	Name
36394	-----	Tucker (long arm) Tuck Guide complete for 36395 and 36670, Nos. 9D, 423C, 803C, 1510E, 35511, 35517, 35518, 35524, 35525, 36389 to 36393, 50134E, two each 1115F, 1177J, 1520J, 56814 and three wood screws 1-1/4 in. No. 10...
36395	-----	Tucker (long arm) complete, Nos. 35528, 36388, 36394 and two 402J.....
36413	-----	Hemmer (foot) plain bottom, 1/16 in. hem.
36414	-----	" " " " 3/32 in. hem.
36416	-----	" " " " 3/16 in. hem.
36464	21817	Presser Foot Spring Guide, for 36465.....
36465	21817	" " (right hand spring guide) with 665J and 36464, for 1/32 in. to 5/16 in. gauges.....
36480	-----	Hemmer (foot) plain bottom, 5/32 in. hem.
36524	-----	" " 5/32 in. hem, with guide on bottom to the right of needle hole...
36574	22228	Presser Foot, for 36575.....
36575	-----	" " 36574 with 36576 and two 50202J.....
36576	22228	Presser Foot Finger Guard, for 36575.....
36637	22228	Ruffler Frame Spring Plate, for 121123...
36638	22228	" Ribbon Guide, for 121123.....
36641	22228	" Ruffling Blade Holder Guide, for 121123.....
36642	22228	Ruffler Ruffling Blade Holder Guide Rivet for 121123.....
36644	22228	Ruffler Separating Blade, for 121501.....
36644	22228	" Shirring Blade, for 120819.....
36646	22228	" Separating Blade Holder Friction Spring, for 121123.....
36647	22228	Ruffler Separating Blade Holder Hinge Stud, for 121123.....
36648	22228	Ruffler Separating Blade Holder Stop Stud for 121123.....
36654	21839	Presser Foot, for tucking shirt bosoms, for 36670.....
36670	-----	Tucker (long arm) complete, for tango tucking, Nos. 36388, 36394, 36654 and two 402J.....
36696	21854	Hemmer Scroll (lower) Spring Lock Pin, for 121665 and 121669.....
36714	-----	Presser Foot with 233J, for 36717.....
36715	21817	" " Guide (right) with 36716, for 36717.....
36716	21817	Presser Foot Guide Stud, for 36715.....
36717	21817	Presser Foot complete with Adjustable Guide (right) Nos. 36714 and 36715...

NUMERICAL LIST OF PARTS

No.	Plate	Name
36773	21819	Presser Foot, for braiding.....
36819	21844	Finger Guard Friction Washer, for 121327.
36820	21844	" " Holder with 196J, for 121327
39026	21853	Hemmer Hinge Screw Washer, for 121679....
40264	21840	Rotating Hook Bobbin.....
40274	22224	" " Section, for 127097 and 127239.....
40316	-----	Presser Foot Plate, for 40318.....
40317	-----	" " Shank, for 40318.....
40318	5882	Presser Foot (hinged) complete, for lace running, for 35540, Nos. 40316, 40317 and 62527.....
40322	21839	Presser Foot (narrow) for 36395.....
40392	21840	Rotating Hook Bobbin Case Latch, for 40393
40393	-----	" " " Hinge, Nos. 2974 40392 and 125320, for 52237.....
40394	21840	Rotating Hook Bobbin Case Tension Spring, for 52236.....
41339	2833	Bobbin Winder Base, for 60456.....
41340	2833	" " Frame, for 60456.....
41341	2833	" " " Spring, for 60456....
41342	2833	" " Pulley with 200F, for 60456
41343	2834	" " Spindle, for 60456.....
41344	2834	" " Stop Latch, for 60456.....
41345	2834	" " " " Finger, for 60456
41346	2834	" " " " Lever, for 60456
41347	2833	" " Nos. 60456 and two each 9331 and wood screws 1 in. No. 10 R.H., for 41346.....
41348	-----	Bobbin Winder (swinging automatic, right hand) complete, Nos. 27308 and 41347.
41400	22226	Machine Rest Pin (wood) Accessories.....
41583	21834	Bobbin Winder Frame with 457C, for 60845.
41585	21834	" " Pulley with 171J, for 60845
41586	21834	" " Spindle, for 60845.....
41587	21834	" " Stop Latch, for 60845.....
41588	21834	" " " " Tripping Arm with 185H, for 60845.....
41593	5936	Bobbin Winder Tension Spring, for 150460.
41594	5936	" " " Stud, for 150460...
41595	5936	" " " Thread Guard, for 150460.....
41913	21834	Bobbin Winder Bracket with 457C, for 60845
41914	21834	" " Frame Spring, for 60845.....
41915	21834	" " 60845 with 880E and 25446, for 150461.....
42367	21836	Arm Oil Tube Packing (braided cotton) for 52185 and 127187.....
42614	21843	Bobbin Winder Stop Latch Hinge Stud, for 60845.....

NUMERICAL LIST OF PARTS

No.	Plate	Name
43525	21854	Binder Steady Pin, for 121398.....
43525	21854	Hemmer Scroll (lower) Spring Position Pin for 121667.....
43944	5936	Tension Releasing Lever.....
44139	21843	Machine Hinge Plate, for 44140.....
44140	-----	Machine Hinge complete, Nos. 12361, 44139 and merlized wood screw 1-1/4 in. No. 14 (Accessories).....
44253	22228	Feed Dog, 16 teeth (16 teeth to the inch) for 44255 and 44256.....
44255	-----	Throat Plate, small needle hole, for 44253
44256	22228	" " large needle hole, for 44253
50053W	22218	Arm Side Cover Thumb Screw.....
50083C	22220	Feed Connecting Link Hinge Stud Set Screw for 52074.....
50117E	22220	Feed Dog Screw.....
50134E	5885	Tucker (long arm) Tuck Guide Base Screw Stud, for 36394.....
50190W	22220	Face Plate Thumb Screw.....
50190W	22220	Guide Thumb Screw.....
50191C	22220	Feed Lifting Rock Shaft Screw Center, for 52097.....
50191C	22220	Feed Rock Shaft Screw Center, for 52097..
50202J	22228	Presser Foot Finger Guard Screw, for 36575
50302J	21844	Finger Guard Holder Set Screw, for 120858
50304C	21842	Tension Stud, for 52098.....
50305C	22224	" " Set Screw, for 52083.....
50316J	21844	Finger Guard Screw, for 121327.....
51068R	22218	Arm Shaft (horizontal) Bevel Gear Case Screw, for 142003.....
51068R	22218	Rotating Hook Shaft Bevel Gear Case Screw for 142004.....
51097J	21843	Binder Thumb Screw, for 121168.....
51097J	21843	Tape Reel Arm Thumb Screw, for 121168....
51219F	21844	Ruffler Driving Lever Hinge Screw, for 121123.....
51221F	22228	Ruffler Ruffling Blade Holder Hinge Screw for 121123.....
51272C	21844	Ruffler Rolle Stud and Needle Clamping Screw, for 121451.....
51371K	21844	Ruffler Driving Lever Adjusting Thumb Screw (lower) for 121121.....
52014	21841	Needle Bar Bushing (upper).....
52016	5936	Presser Bar Lifter.....
52018	22224	Rotating Hook Bobbin Case Holder Position Bracket.....
52022	21842	Thread Take-up Lever with 52130, for 52025
52023	21842	" " Hinge Pin, for 52025
52024	21842	" " Link, for 52025.....

NUMERICAL LIST OF PARTS

No.	Plate	Name
52025	-----	Thread Take-up Lever complete for 52269, Nos. 52022 to 52024.....
52027	21842	Thread Guard (side of arm).....
52028	22226	Lifting Lever Connecting Rod, for 52029, 52030 and 52038.....
52029	-----	Foot Lifter complete, Nos. 76D, 766D, 802D 1521J, 4890, 4885, 5598, 5670, 12240, 12241, 12416, 16510, 52028 and two 178E.....
52030	-----	Knee Lifter complete (power table) Nos. 76D, 766D, 802D, 1521J, 2777, 5598, 12240, 12241, 12416, 16510, 52028 and two 178E.....
52031	21853	Feed Dog, 19 teeth (22 teeth to the inch) for 52032 and 52033.....
52032	21853	Throat Plate, large needle hole, for 52031
52033	21839	" " small needle hole, for 52031
52038	-----	Knee Lifter complete (bench stand) Nos. 76D, 766D, 802D, 1521J, 5598, 12240, 12241, 12416, 16510, 19168, 52028 and two 178E.....
52045	21836	Oil Tube Packing (wick) for 127133.....
52051	22226	Face Plate, for 52052.....
52052	-----	Face Plate complete, Nos. 52051, 52053, 52170 and two 228J.....
52053	22220	Face Plate Thread Guard (lower) for 52052
52055	21819	Presser Foot, for 35208 and 35236.....
52056	21817	Presser Foot.....
52065	21838	Feed Lifting Rock Shaft, for 52264.....
52068	21838	" Rock Shaft, for 52069.....
52069	-----	Feed Rock Shaft complete, Nos. 29633 and 52068.....
52073	22220	Feed Connecting Link Hinge Stud, for 52118
52074	21837	" Regulator with 50083C, for 52118....
52082	21842	Thread Take-up Spring, for 52092.....
52083	21842	" " Regulator with 50305C, for 52092.....
52085	-----	Feed Forked Connection 24037 with 375C, 1518J and 52165.....
52092	-----	Tension complete, Nos. 13710, 32572, 32574 52082, 52083, 52098 and two 2102.....
52093	-----	Feed Regulator 52118 with 818D.....
52097	-----	" Lifting Rock Shaft Screw Center 50191C with 1513J.....
52097	-----	Feed Rock Shaft Screw Center 50191C with 1513J.....
52098	-----	Tension Stud 50304C with 1560C, for 52092
52118	-----	Feed Regulator 52074 with 52073, for 52093
52130	21842	Thread Take-up Lever Thread Eyelet Bush- ing, for 52022.....

NUMERICAL LIST OF PARTS

No.	Plate	Name
52146	21842	Arm Shaft (horizontal) Back Bearing Oil Cup Pad (braided cotton) for 95-100 Machine.....
52146	21842	Arm Shaft (horizontal) Front Bearing Oil Pad (braided cotton) for 95-100 Machine.....
52155	21841	Needle Bar (hollow) with 857H.....
52165	22220	Feed Connecting Link, for 52085.....
52167	21841	Oil Tube Bracket 127091 with 127133, for oiling 52165.....
52170	22220	Face Plate Thread Guard (upper) for 52052
52171	21842	Thread Eyelet, for 52268.....
52176	22226	Balance Wheel (power disc) 2-3/16 in. pulley with two 448C.....
52180	21836	Arm Oil Tube (long) with 52184, for oiling 52022.....
52182	21836	Arm Oil Tube with 52184, for oiling 127231.....
52183	21836	Arm Oil Tube with 52184, for oiling 52024 and 127156, for 127193 and 150460....
52184	21836	Arm Oil Tube Packing (wick) for 52180, 52182 and 52183.....
52185	21836	Arm Oil Tube (short) with 42367, for oiling 52022.....
52188	21846	Presser Foot (solid) for 52190, for Cuff Work.....
52189	21845	Presser Foot (solid) for 52190, for Collar Work.....
52190	21845	Throat Plate, for 20164, for Collar and Cuff Work.....
52193	22218	Arm Shaft (horizontal) Flanged Bushing (back) Oil Pad (inside) braided cotton, for 52260.....
52193	22218	Arm Shaft (horizontal) Flanged Bushing (front) Oil Pad (inside) braided cotton, for 52196.....
52193	22218	Arm Shaft (horizontal) Intermediate Bushing Oil Pad (inside) braided cotton, for 52262.....
*52195	-----	Arm Shaft (horizontal) Flanged Bushing (front) for 52196.....
52196	21837	Arm Shaft (horizontal) Flanged Bushing (front) 52195 with 52193 and 52198, for 52256.....
52198	22218	Arm Shaft (horizontal) Flanged Bushing (front) Oil Pad (outside) felt, for 52196.....
52207	21840	Needle Bar Connecting Link Lubricating Pad (wood) for 127231.....

NUMERICAL LIST OF PARTS

No.	Plate	Name
52210	22220	Feed and Feed Lifting Eccentric Lubricating Pad (long) wood, for 52218.....
52211	22220	Feed and Feed Lifting Eccentric Lubricating Pad (short) wood, for 52218.....
52214	-----	Needle Bar Crank 52247 with 401E and 127009, for 52258.....
52216	22224	Thread Take-up Crank, for 52270.....
52218	21837	Feed and Feed Lifting Eccentric with 448C 1299C, 52210 and 52211, for 52231....
52231	-----	Feed and Feed Lifting Eccentric 52218 with 127152.....
52235	-----	Rotating Hook Bobbin Case, for 52236.....
52236	-----	" " " " 52235 with 591F 1380E and 40394, for 52237.....
52237	22224	Rotating Hook Bobbin Case complete for 127240 and 127241, Nos. 592E, 2975, 40393 and 52236.....
52239	22218	Arm Spool Pin and Thread Eyelet, for 127193.....
52239	22218	Bobbin Winder Tension Bracket Spool Pin and Thread Eyelet, for 150460.....
52240	21837	Arm Shaft (horizontal) Bevel Gear Case Holder, for 95-100 Machine.....
52246	21841	Needle Bar Crank with 1036C, 1037C and 1065C, for 52256.....
52247	21841	Needle Bar Crank with 1036C, 1037C and 1065C, for 52214.....
*52252	-----	Arm with 15404 and two each 15405 and 56015, for 95-80 Machine.....
*52253	-----	Arm with 15404 and two each 15405 and 56015, for 95-100 Machine.....
52254	21836	Arm Oil Tube, for oiling 52262.....
52255	21838	" Shaft (horizontal) for 52256.....
52256	-----	" " " " 52255 with 52196 and 52246, for 95-80 Machine.....
52257	21838	Arm Shaft (horizontal) with 127067, for 52258.....
52258	-----	Arm Shaft (horizontal) 52257 with 52214, for 95-100 Machine.....
*52259	-----	Arm Shaft (horizontal) Flanged Bushing (back) for 52260.....
52260	21837	Arm Shaft (horizontal) Flanged Bushing (back) 52259 with 52193 and 52289, for 95-80 Machine.....
*52261	-----	Arm Shaft (horizontal) Intermediate Bushing, for 52262.....
52262	21837	Arm Shaft (horizontal) Intermediate Bushing 52261 with 52193 and 52263.....
52263	22218	Arm Shaft (horizontal) Intermediate Bushing Oil Pad (outside) felt, for 52262.

NUMERICAL LIST OF PARTS

No.	Plate	Name
52264	-----	Feed Lifting Rock Shaft complete, Nos. 52065 and 52265.....
52265	21837	Feed Lifting Rock Shaft Crank 52271 with 157J and 52267, for 52264.....
52266	-----	Feed Lifting Rock Shaft Crank Slide Block for 52267.....
52267	22220	Feed Lifting Rock Shaft Crank Slide Block 52266 with 125060, for 52265.....
52268	21840	Needle Bar Bushing (lower).....
52269	-----	Thread Take-up complete, Nos. 11204, 52025 and 52270.....
52270	-----	Thread Take-up Crank 52216 with 775E and 127232, for 52269.....
*52271	-----	Feed Lifting Rock Shaft Crank, for 52265.
*52275	-----	Arm Shaft (upright) Bushing (lower) for 52276.....
52276	21837	Arm Shaft (upright) Bushing (lower) 52275 with 52279 and 52280.....
*52277	-----	Arm Shaft (upright) Bushing (upper) for 52278.....
52278	21837	Arm Shaft (upright) Bushing (upper) 52277 with 52279 and 52280.....
52279	22218	Arm Shaft (upright) Bushing Oil Wick (inside) braided cotton, for 52276 and 52278.....
52279	22218	Rotating Hook Shaft Bushing Oil Wick (inside) braided cotton, for 52286 and 52288.....
52280	22218	Arm Shaft (upright) Bushing Oil Pad (outside) felt, for 52276 and 52278.....
52280	22218	Rotating Hook Shaft Bushing Oil Pad (outside) felt, for 52286 and 52288.....
52281	22218	Arm Shaft (upright) Bevel Gear (lower) with two 1259C.....
52282	22218	Arm Shaft (upright) Bevel Gear (upper) with two 1259C.....
*52283	-----	Bed.....
*52285	-----	Rotating Hook Shaft Bushing (back) for 52286.....
52286	21841	Rotating Hook Shaft Bushing (back) 52285 with 52279 and 52280.....
*52287	-----	Rotating Hook Shaft Bushing (front) for 52288.....
52288	21841	Rotating Hook Shaft Bushing (front) 52287 with 52279 and 52280.....
52289	22218	Arm Shaft (horizontal) Flanged Bushing (back) Oil Pad, (outside) felt, for 52280.....
52290	21836	Arm Oil Tube Hole Plug.....

NUMERICAL LIST OF PARTS

No.	Plate	Name
52337	5936	Slack Thread Regulator.....
52338	5936	Presser Bar Guide Bracket with 223C and 453C.....
52452	21837	Feed Bar.....
52454	22224	Thread Retainer.....
52486	21842	Arm Shaft (horizontal) Ball Bearing (back) Locking Pin, for 95-100 Machine
52487	21842	Arm Shaft (horizontal) Ball Bearing (back) Locking Pin Cone, for 95-100 Machine.....
54897	21842	Arm Shaft (horizontal) Back Bearing Oil Cup, for 95-100 Machine.....
54897	21842	Arm Shaft (horizontal) Front Bearing Oil Cup, for 95-100 Machine.....
56015	21836	Arm Oil Tube, for oiling 142006, for 52252 and 52253.....
56813	-----	Feed Bar Screw Center 313C with 1519J....
56814	-----	Tucker (long arm) Tuck Guide Bracket Screw Center 307C with 1513J, for 36394.....
56848	-----	Bell Crank 5596 with 5599 and 5601, for 5598.....
56864	21819	Chain Hook (large) for 5670.....
56865	21819	" " (small) for 5670.....
60456	-----	Bobbin Winder, Nos. 152F, 207J, 1429D, 1550H, 41339 to 41346 and three 1430D for 41347.....
60845	-----	Bobbin Winder, Nos. 7958, 34105, 41583, 41585 to 41588, 41913, 41914 and 42614, for 41915.....
62527	21839	Presser Foot Hinge Pin, for 24983 and 40318.....
68350	22218	Arm Shaft (horizontal) Back Bearing Oil Cup, for 95-80 Machine.....
68350	22218	Arm Shaft (horizontal) Front Bearing Oil Cup, for 95-80 Machine.....
120143	-----	Presser Foot Plate, for 120144.....
120144	21847	Presser Foot (hinged) complete, for button stays on dress shirts, Nos. 7298, 19335 and 120143.....
120342	21835	Oiler (copper plated) with 120343 (Accessories).....
120343	21835	Oiler Spout, 3-1/2 in. long, for 120342..
120536	22226	Tape Reel Disc with 120538 and 120539, for 121168.....
120537	-----	Tape Reel Disc Pin, for 121412.....
120538	-----	" " " Stud (wood) for 120536....
120539	-----	" " " Sleeve, for 120536....
120603	5919	Hemmer (foot) for 1/8 in. hem.....

NUMERICAL LIST OF PARTS

No.	Plate	Name
120804	5919	Hemmer (foot) for 5/32 in. hem.....
120805	5919	" " " 3/16 in. hem.....
120806	5920	" " " 1/4 in. hem.....
120807	5920	" " " 5/16 in. hem.....
120812	22228	Ruffler Driving Lever Bushing, for 121123
120813	22228	" " " Friction Washer, for 121123.....
120818	-----	Ruffler Shirring Blade Holder, for 120819
120819	-----	" " " " 120818 with 36644 and two 120829, for 121451.....
120828	21839	Presser Foot (single toe) for gathering, for fine work.....
120829	22228	Ruffler Ruffling Blade Rivet, for 121120.
120829	22228	" Separating Blade Rivet, for 121501
120829	22228	" Shirring Blade Rivet, for 120819.
120830	-----	" Separating Blade Holder, for 121501.....
120837	5920	Hemmer (foot) plain bottom, 1/8 in. hem, slotted for lace.....
*120838	5919	Hemmer Tongue, for 120804 and 120805.....
*120839	21844	" " " 120806 and 120807.....
*120843	5919	" " " 120803 and 120938.....
120858	21844	Finger Guard Holder with 50302J, for 121562.....
120898	5921	Hemmer (foot) for 1/16 in. to 1/8 in. hem, for China Silk, etc.....
120911	5921	Hemmer (foot) for 5/32 in. to 1/4 in. hem, for China Silk, etc.....
120938	5921	Hemmer (foot) for 3/32 in. hem.....
120939	5919	" Folder, for 120803 to 120807 and 120938.....
120977	-----	Piping Attachment, for 35245.....
120991	21852	Hemmer on Shank, for 1/16 in. to 1/4 in. gauges.....
121116	22229	Ruffler Driving Lever, for 121123.....
121117	22229	" Frame, for 121123.....
121118	22228	" Ruffling Blade, for 121120.....
121119	22228	" " " Holder, for 121120
121120	-----	" " " " 121119 with 121118 and two 120829, for 121123....
121121	22229	Ruffler Ruffling Blade Lever with 560B and 51371K, for 121123.....
121123	22229	Ruffler complete for 121451, Nos. 240B, 1700J, 1772J, 36637, 36638, 36641, 36642, 36646 to 36648, 51219F, 51221F 120812, 120813, 121116, 121117, 121120 121121 and 121501.....
121167	-----	Binder Folder on Shank, for 121168.....

NUMERICAL LIST OF PARTS

No.	Plate	Name
121168	-----	Binder (transverse) on Shank, for 3/4 in. 7/8 in. and 1 in. tape, Nos. 3146, 120536, 121167, 121169, 121397, 121398 121412 and two 51097J.....
121169	21819	Presser Foot, for 121168.....
121326	21844	Finger Guard, for 121327.....
121327	21844	Finger Guard (metal) complete, Nos. 36819 36820, 50316J and 121326.....
121397	21818	Feed Dog, 18 teeth (16 teeth to the inch) for 121168 and 121398.....
121398	21818	Throat Plate with 43525, for 121168 and 121397.....
121412	21819	Tape Reel Arm with 8879, 11656 and 120537 for 121168.....
121451	-----	Ruffler 121123 with 1981, 51272C and 120819.....
121501	-----	Ruffler Separating Blade Holder 120830 with 36644 and two 120829, for 121123
121507	21844	Finger Guard, for 121562.....
121562	21844	Finger Guard (wire) complete, Nos. 120858 121507 and two 236J.....
121587	21838	Grease Gun (3 oz. capacity) for Fitting No. 142005 (Accessories).....
121588	-----	Grease Gun (1/2 lb. capacity) for Fitting No. 142005 (Accessories).....
121646	21848	Feed Dog, 12 teeth (16 teeth to the inch) for Collar Work (second stitching) for 121649.....
121647	21848	Presser Foot with 121648 and two 337J, for 3/16 in., 7/32 in., 9/32 in. and 5/16 in. gauges, for Collar Work (second stitching).....
121648	21848	Presser Foot Edge Guide, for 3/16 in., 7/32 in., 1/4 in., 9/32 in. and 5/16 in. gauges, for 121647.....
121649	21848	Throat Plate, for 121646.....
121653	21847	Hemmer on Shank, for 9/16 in. hem, for button stays on dress shirts.....
121655	21849	Binder on Shank, for facing sleeve plack- ets.....
121656	21849	Presser Foot, for facing sleeve plackets.
121658	21851	Edge Folder with Edge Guide on Shank, for yoking dress shirts, for 121660.....
121659	-----	Presser Foot Plate, for 121660.....
121660	21851	Presser Foot (hinged) complete, for yok- ing dress shirts, for 121658, Nos. 7298, 19223 and 121659.....
121662	21850	Joining Attachment, for shoulder joining dress shirts, for 121663.....

NUMERICAL LIST OF PARTS

No.	Plate	Name
121663	21850	Presser Foot, for shoulder joining dress shirts, for 121662.....
121665	21854	Hemmer Scroll (lower) on Shank with 337B, 36696 and 121667, for 121668.....
121666	21854	Hemmer Scroll (upper) for 121668.....
121667	21854	" " (lower) Spring with 43525; for 121665 and 121669.....
121668	21854	Hemmer on Shank complete, for 7/8 in. to 2 in. hem, for hemming pillow cases, Nos. 121665 and 121666.....
121669	21854	Hemmer Scroll (lower) on Shank 337B, 36696 and 121667, for 121671.....
121670	21854	Hemmer Scroll (upper) for 121671.....
121671	21854	Hemmer on Shank complete, for 2-1/16 in. to 4 in. hem, for hemming pillow cases, Nos. 121669 and 121670.....
121672	21853	Hemmer on Shank, for 121674.....
121673	21853	" Throw-out Arm with 35522, for 121674.....
121674	21853	Hemmer complete on Throw-out Arm, for 2 in. or 3 in. hem, for 121679, Nos. 121672, 121673 and two 1499J.....
121675	21853	Hemmer on Shank, for 121677.....
121676	21853	" Throw-out Arm with 35522, for 121677.....
121677	21853	Hemmer complete on Throw-out Arm, for 1 in. hem, for 121679, Nos. 121675, 121676 and two 1499J.....
121678	21853	Hemmer Tension Spring, for 121679.....
121679	-----	Hemmers complete, for 1 in. and 2 in. or 3 in. hems, for hemming sheets, Nos. 24J, 39026, 121674, 121677 and 121678.....
121680	21853	Presser Foot, for hemming sheets.....
*125060	-----	Feed Lifting Rock Shaft Crank Slide Block Stud, for 52267.....
125320	21840	Rotating Hook Bobbin Case Latch Lever, for 40393.....
127009	21841	Arm Shaft (horizontal) Ball Bearing (front) Cover, for 52214.....
127011	21841	Arm Shaft (horizontal) Ball Bearing (back) for 95-100 Machine.....
127066	21841	Arm Shaft (horizontal) Ball Bearing (front) for 95-100 Machine.....
127067	21842	Arm Shaft (horizontal) Ball Bearing (front) Key, for 52257.....
127072	21837	Arm Shaft (horizontal) Bevel Gear with two 1036C.....
127073	22224	Rotating Hook Shaft Bevel Gear with two 1259C.....

NUMERICAL LIST OF PARTS

No.	Plate	Name
127079	21837	Arm Side Cover.....
127091	21841	Oil Tube Bracket, for 52167.....
127095	21840	Rotating Hook with three 1253C, for 127096
127096	-----	" " 127095 with 127102 and four 1053E, for 127097 and 127239.....
127097	-----	Rotating Hook 127096 with 40274 and three 1367E (for Agents only).....
127102	22224	Rotating Hook Thread Guard, for 127096...
127108	21841	Presser Bar Spring.....
127133	21841	Oil Tube with 52045, for 52167.....
*127143	-----	Arm Shaft (horizontal) Ball Bearing (back) Cover, for 127144.....
127144	21841	Arm Shaft (horizontal) Ball Bearing (back) Cover 127143 with 127145, for 95-100 Machine.....
*127145	-----	Arm Shaft (horizontal) Ball Bearing (back) Cover Oil Lead, for 127144....
127146	21806	Arm Side Cap.....
127152	21837	Feed and Feed Lifting Eccentric Sleeve, for 52231.....
127156	21838	Feed Lifting Rock Shaft Connecting Rod with two 966E.....
127187	21836	Arm Oil Tube with 42367, for oiling 127152 for 127193 and 150460.....
127192	21837	Arm Top Cover, for 127193.....
127193	21837	" " " 127192 with 52183, 52239, 127187 and 127255.....
127231	21840	Needle Bar Connecting Link with 52207, for 127232.....
127232	-----	Needle Bar Connecting Link 127231 with 24041, for 52270.....
*127239	-----	Rotating Hook 127096 with 40274, 127242 and three 1367E, for 127240.....
127240	-----	Rotating Hook 127239 with 52237.....
127241	-----	" " Bobbin Case 52237 with 127242.....
127242	22224	Rotating Hook Bobbin Case Holder, for 127239 and 127241.....
127255	22218	Arm Top Cover Positioning Disc, for 127193
127255	22218	Bobbin Winder Tension Bracket Positioning Plate, for 150460.....
140184E	21836	Arm Shaft (horizontal) Bevel Gear Case Plug Screw, for 142003.....
140184E	21836	Rotating Hook Shaft Bevel Gear Case Plug Screw, for 142004.....
142003	21837	Arm Shaft (horizontal) Bevel Gear Case (two pieces) with 51068R, 140184E, and 142005.....

NUMERICAL LIST OF PARTS

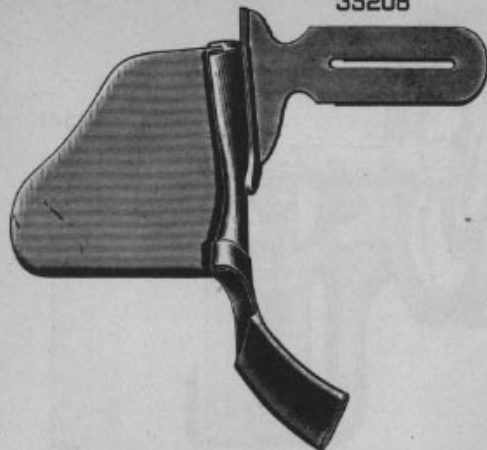
No.	Plate	Name
142004	21841	Rotating Hook Shaft Bevel Gear Case (two pieces) with 51068R, 140184E and 142005.....
142005	21836	Arm Shaft (horizontal) Bevel Gear Case Alemite Fitting, for 142003.....
142005	21836	Rotating Hook Shaft Bevel Gear Case Alemite Fitting, for 142004.....
142006	21837	Arm Shaft (upright).....
142007	21838	Rotating Hook Shaft.....
142008	22224	" " " Bushing (front) Oil Cup.....
150203	20335	Thread Unwinder Spool Rest Cushion (felt) for 225258.....
150459	21834	Bobbin Winder Tension Bracket with 460C, for 150460.....
150460	-----	Bobbin Winder Tension Bracket complete, for 150461, Nos. 41593 to 41595, 52183 52239, 127187, 127255, 150459 and two 2455.....
150461	-----	Bobbin Winder (swinging automatic, left hand) complete, Nos. 41915 and 150460
200056E	3471	Bobbin Winder Stop Latch Screw, for 225382
200082D	3471	" " Tension Bracket Screw, for 225382.....
200299H	3471	Bobbin Winder Stop Latch Trip Lever Hinge Screw, for 225382.....
200380C	3471	Bobbin Winder Pulley Set Screw, for 202473
200383C	22230	Thread Unwinder Spool Rest Rod Set Screw, for 202490.....
201018C	22230	Thread Unwinder Spool Rest Set Screw, for 225257.....
201499B	3471	Bobbin Winder Tension Stud, for 225461...
201572B	3471	" " " " Thumb Nut, for 225462.....
201696J	22230	Thread Unwinder Thread Guide Lock Nut, for 225258.....
202277	3471	Bobbin Winder Frame Oil Packing (wick) for 225453.....
202407	3471	Bobbin Winder Tension Spring, for 225462.
202473	3470	" " Pulley with 200380C, for 225382.....
202478	3471	Bobbin Winder Stop Latch Trip Lever, for 225382.....
202490	20335	Thread Unwinder Spool Stand with 200383C, for 225258.....
225257	20335	Thread Unwinder Spool Rest with 201018C, for 225258.....

NUMERICAL LIST OF PARTS

No.	Plate	Name
225258	20335	Thread Unwinder complete, for two spools or two large cones of thread, Nos. 201696J, 202490, 225257, 225324, 225326, 225388, two each 150203, 225391 and three wood screws 7/8 in. No. 12 F.H.....
225322	22230	Thread Unwinder Thread Guide Rod Washer, for 225324.....
225324	20335	Thread Unwinder Thread Guide Rod with 208E and 225322, for 225258.....
225326	20335	Thread Unwinder Thread Guide Position Cup for 225258.....
225381	3470	Bobbin Winder Spindle, for 225382.....
225382	3469	Bobbin Winder (swinging automatic, right hand) complete, for power table, Nos. 200056E, 200082D, 200299H, 202473, 202478, 225381, 225433, 225444, 225453 to 225456, 225458, 225462, 228026, two each 225459 and wood screws 3/4 in. No. 12 R.H.....
225388	20335	Thread Unwinder Spool Rest Rod, for 225258
225390	7234	" " Thread Cone Holder, for inverted cones, for 225258.....
225391	20335	Thread Unwinder Thread Guide, for 225258.
225433	3469	Bobbin Winder and Tension Bracket Base, for 225382.....
225438	3471	Bobbin Winder Frame Oil Well Cap, for 225453.....
225444	3471	Bobbin Winder Stop Latch, for 225382.....
225453	3470	" " Frame with 202277 and 225438, for 225382.....
225454	3471	Bobbin Winder Frame Hinge Pin, for 225382.
225455	3471	" " " Spring, for 225382...
225456	3471	" " " " Plunger, for 225382.....
225458	3471	Bobbin Winder Stop Latch Thumb Lever, for 225382.....
225459	3471	Bobbin Winder Stop Latch Thumb Lever Hinge Stud, for 225382.....
225459	3471	Bobbin Winder Stop Latch Thumb Lever Joint Stud, for 225382.....
225461	3471	Bobbin Winder Tension Bracket with 201499B, for 225462.....
225462	-----	Bobbin Winder Tension Bracket complete for 225382, Nos. 201572B, 202407, 225461 and two 2102.....
228026	-----	Bobbin Winder Tension Bracket Screw Washer, for 225382.....

PLATE 1971—ONE-HALF SIZE

35208



35236

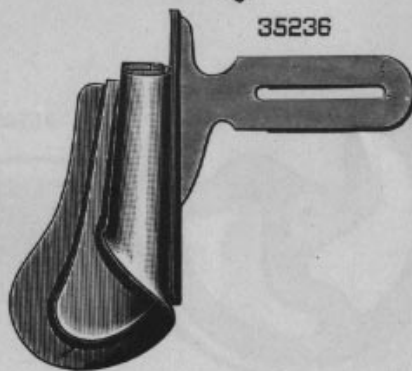


PLATE 2833—ONE-HALF SIZE

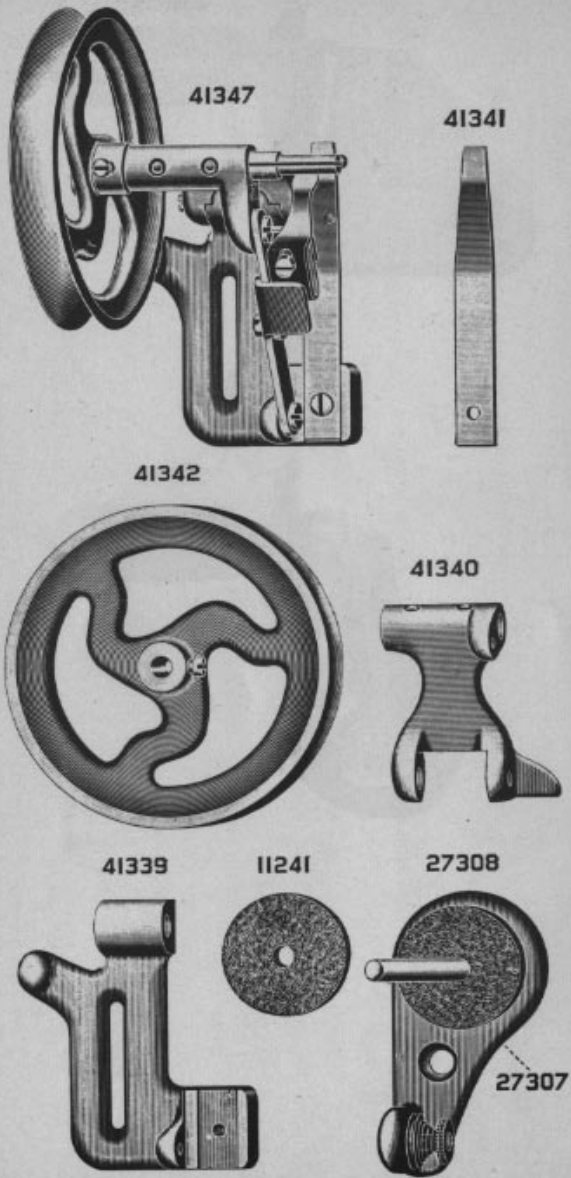


PLATE 2834—FULL SIZE

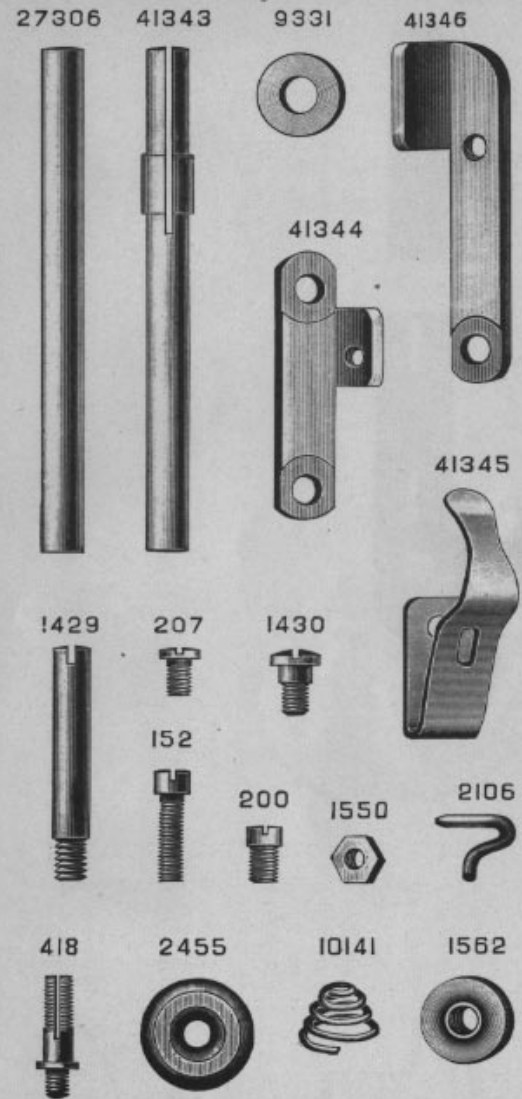


PLATE 3469—ONE-FOURTH SIZE

225362

225433

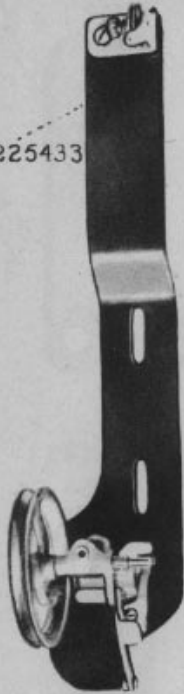


PLATE 3470—ONE-HALF SIZE

202473

225453



225381



PLATE 3471—FULL SIZE

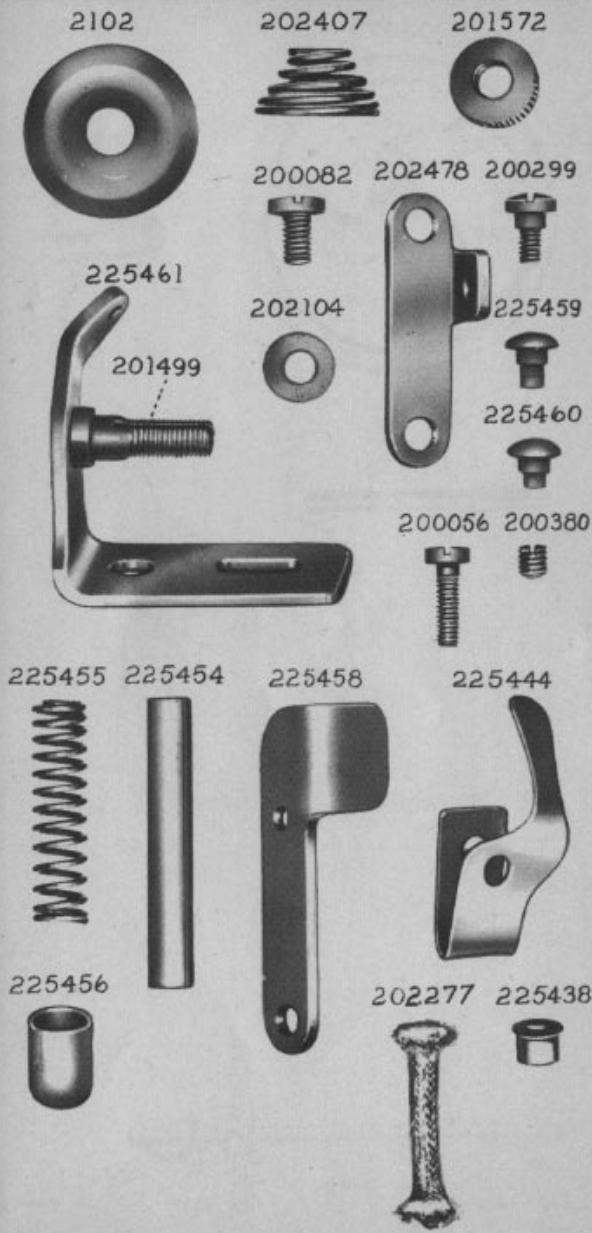


PLATE 5876—ONE-FOURTH SIZE

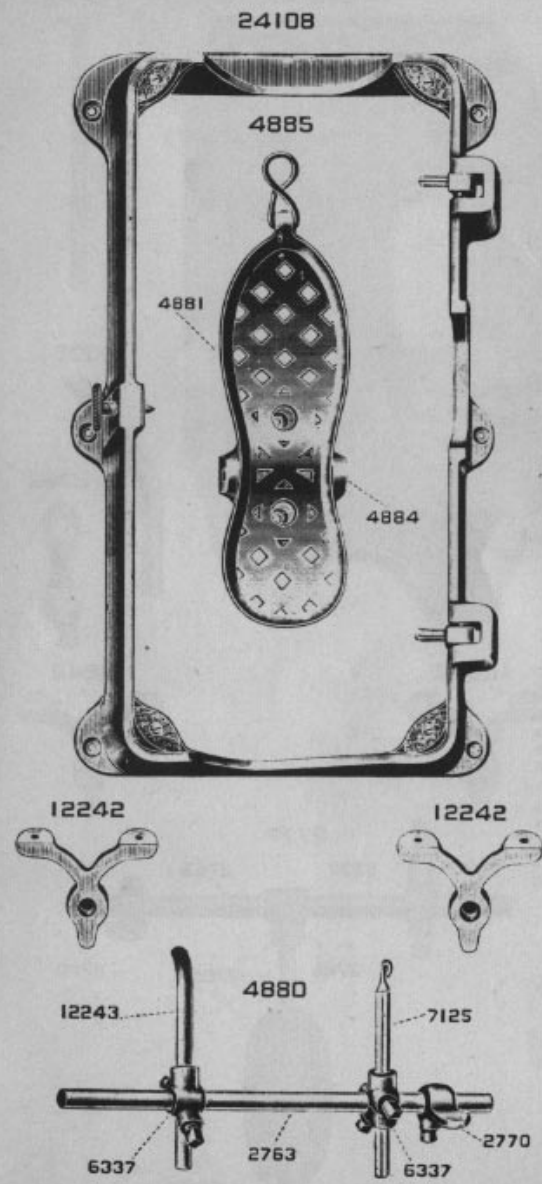


PLATE 5877—ONE-FOURTH SIZE

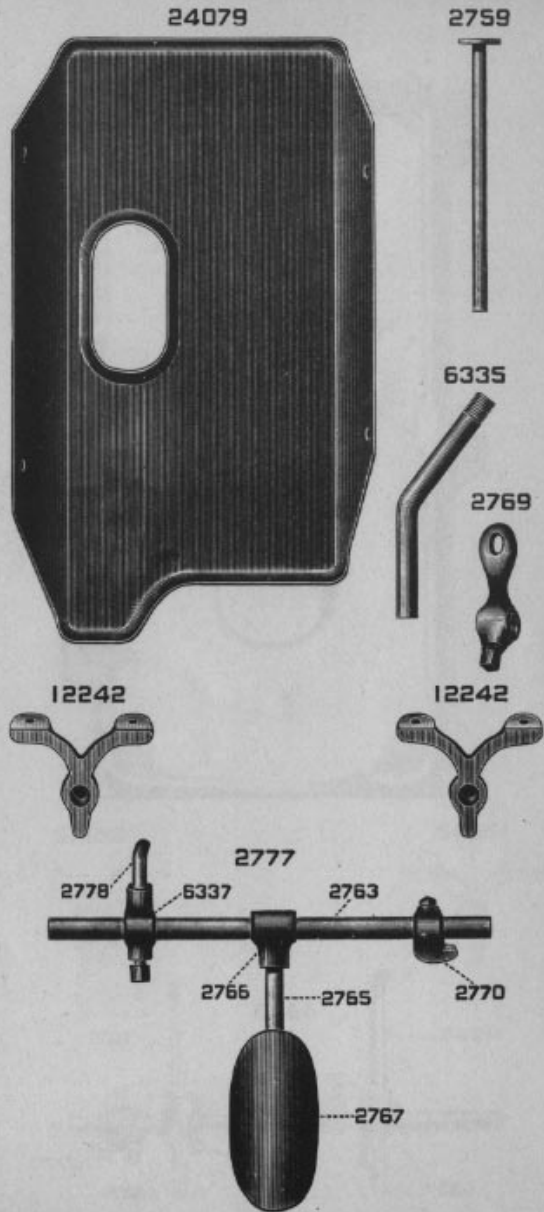


PLATE 5882—FULL SIZE

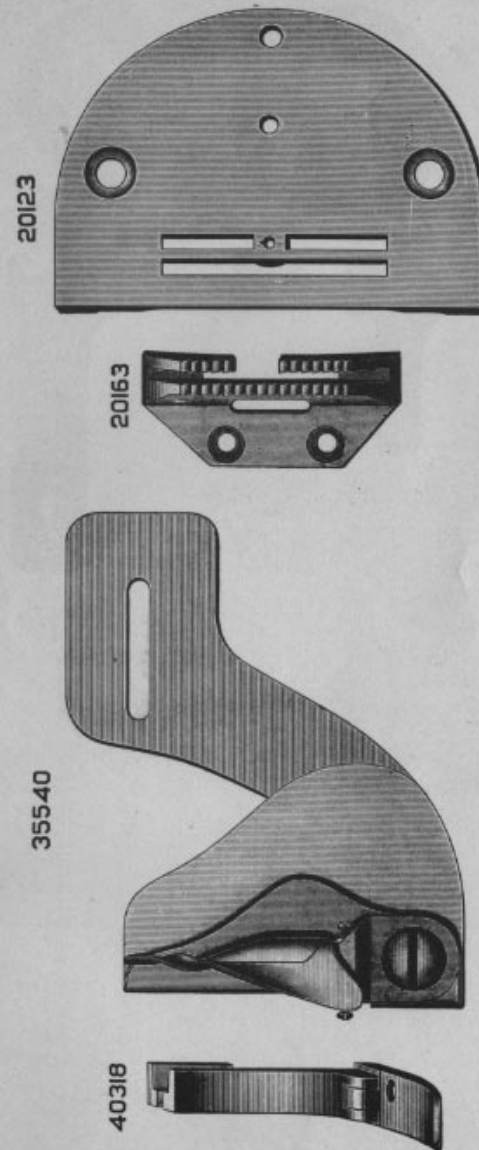


PLATE 5883—ONE-FOURTH SIZE

35517



35518



36392



36389



35525



PLATE 5884—ONE-HALF SIZE

36387



35510



36391



PLATE 5885—FULL SIZE

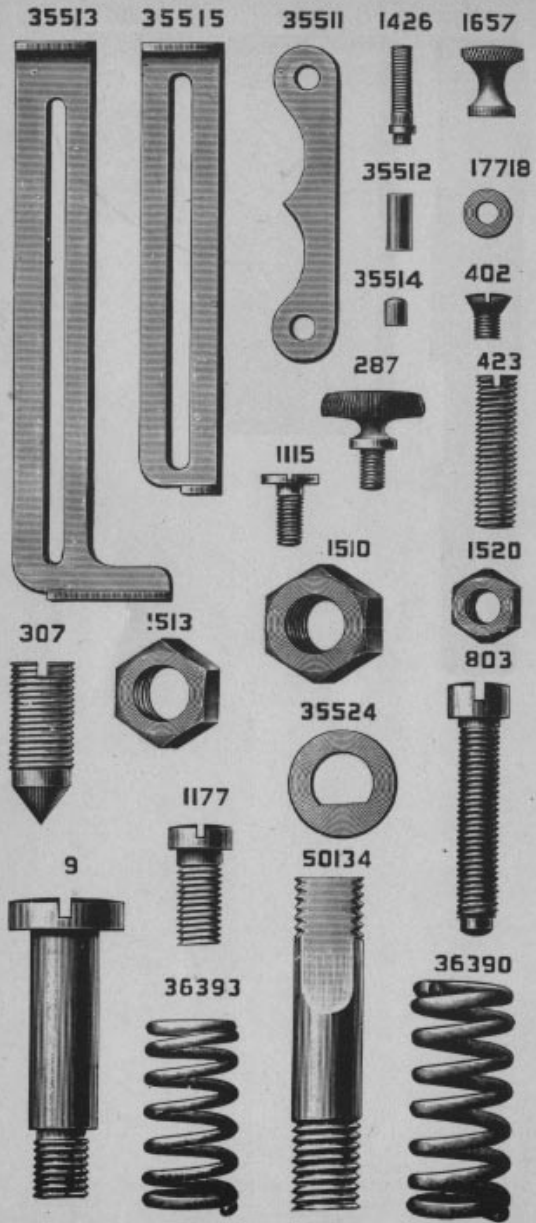


PLATE 5919—FULL SIZE

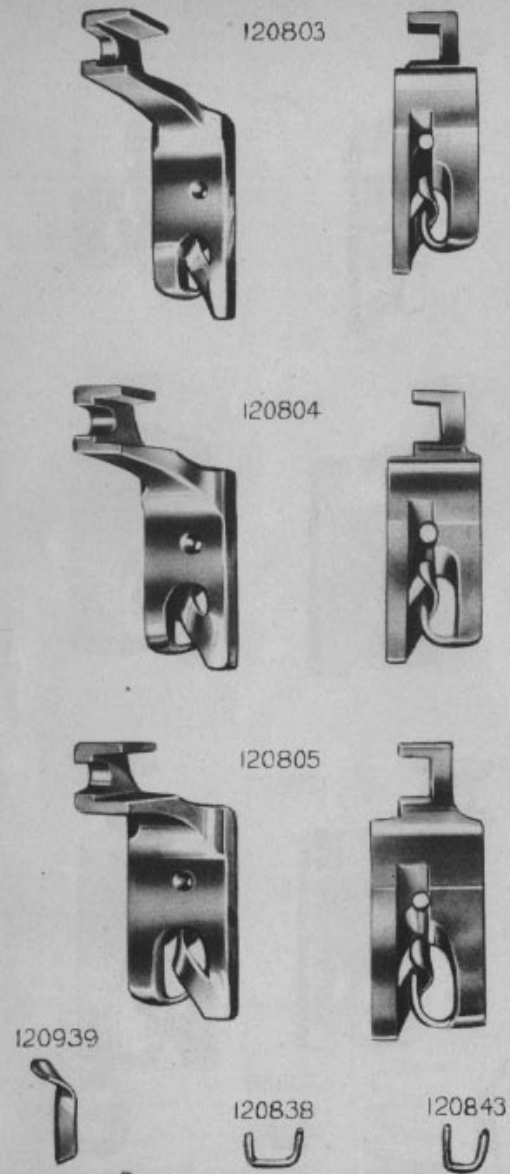


PLATE 5920—FULL SIZE

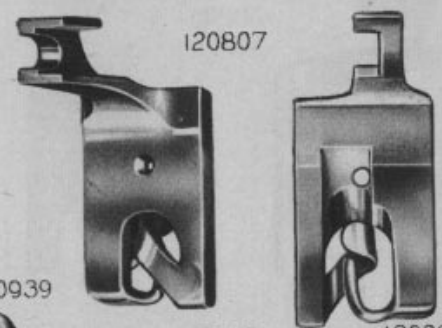
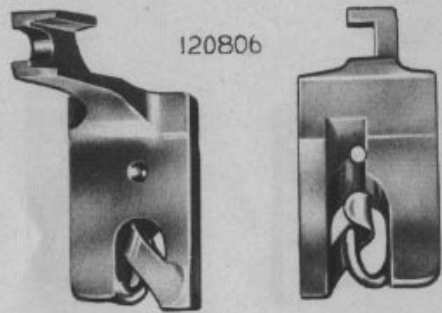
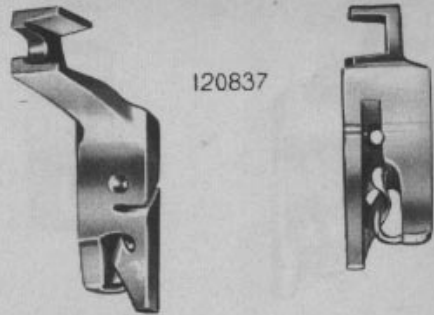


PLATE 5921—FULL SIZE

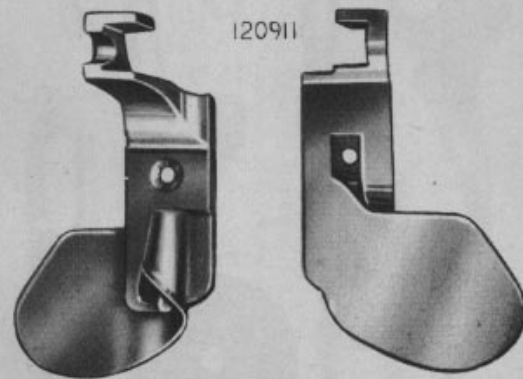
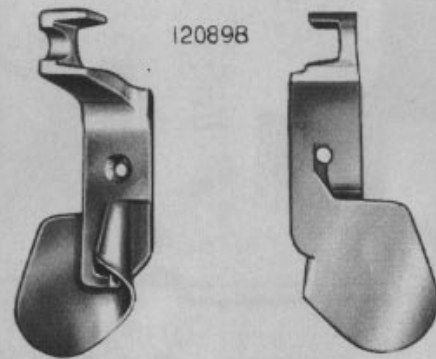
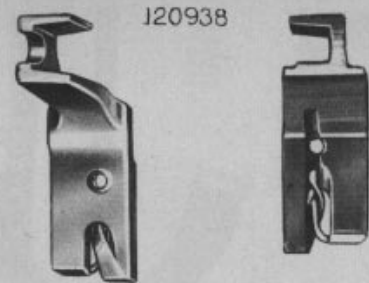


PLATE 5936—FULL SIZE

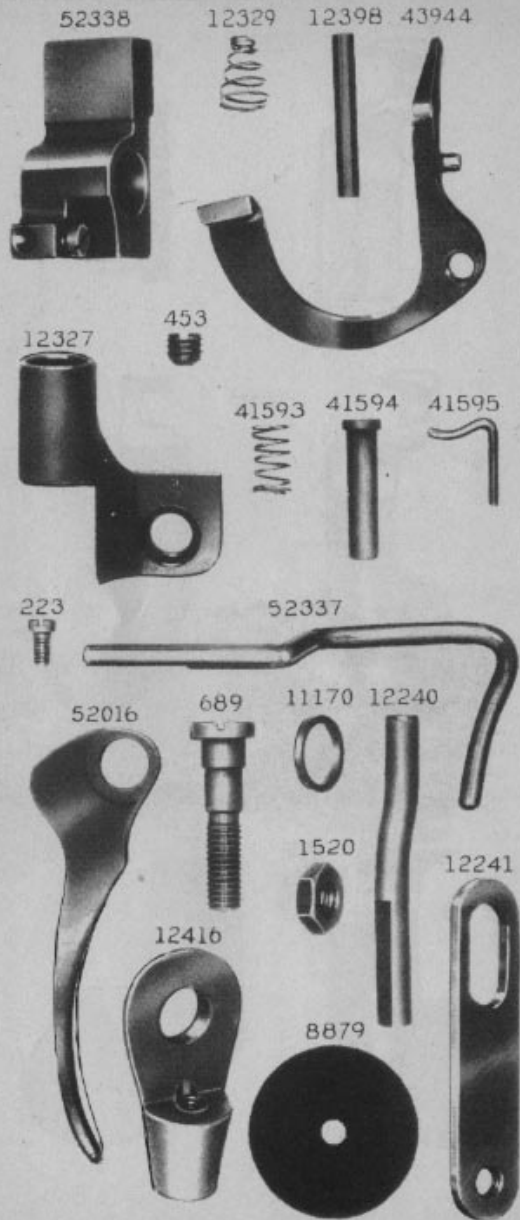


PLATE 7234—ONE-HALF SIZE

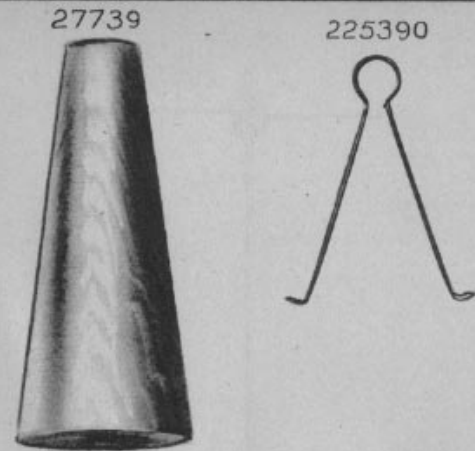


PLATE 20335—ONE-SIXTH SIZE

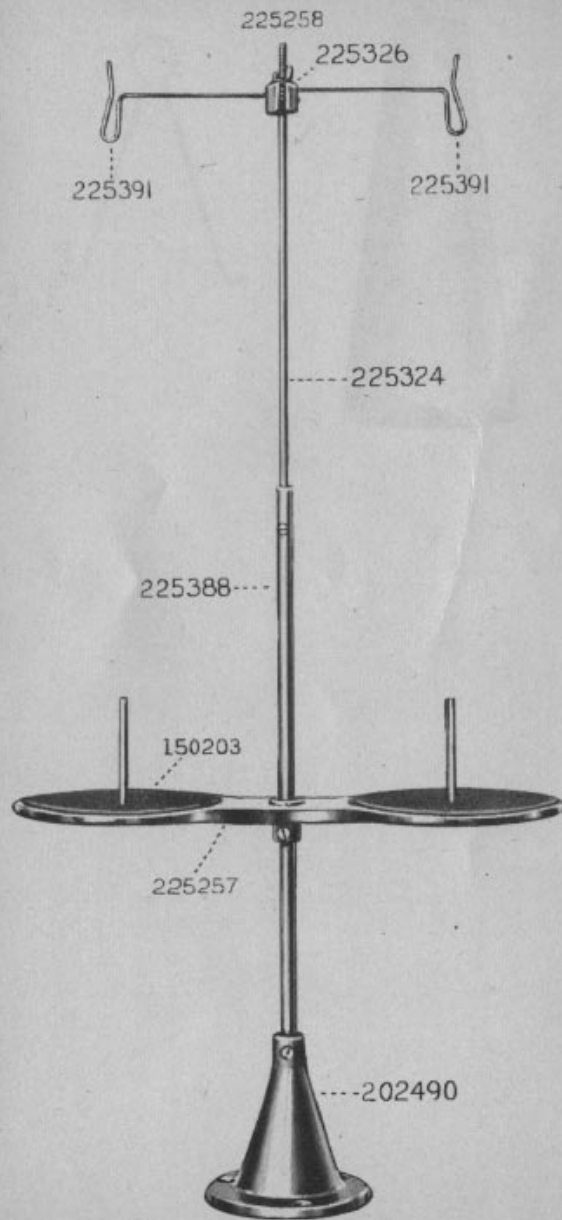


PLATE 21806—FULL SIZE

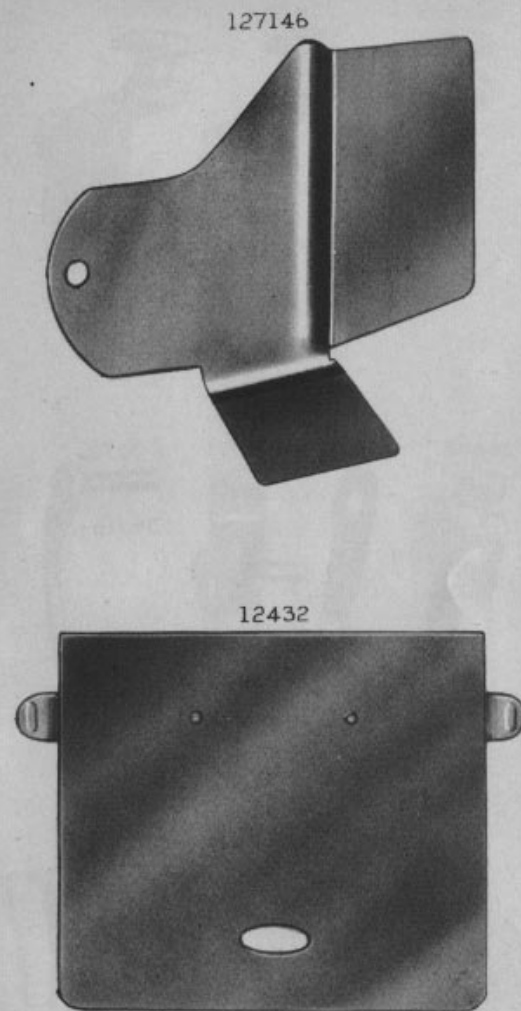


PLATE 21817—FULL SIZE

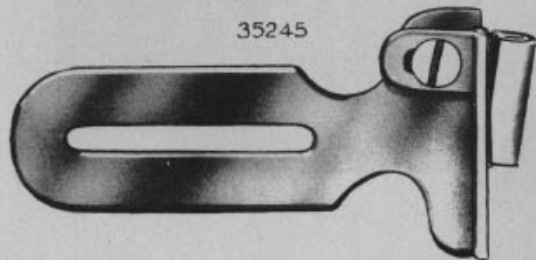
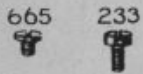
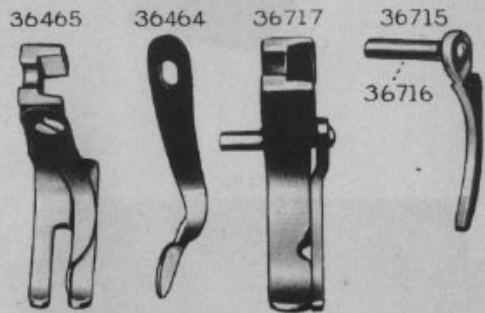
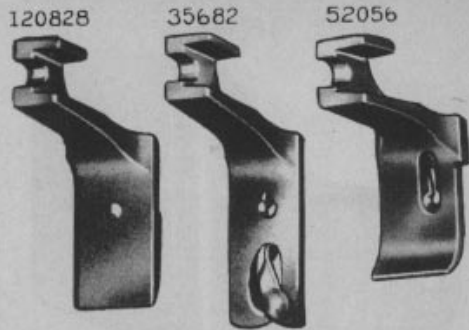


PLATE 21818—FULL SIZE

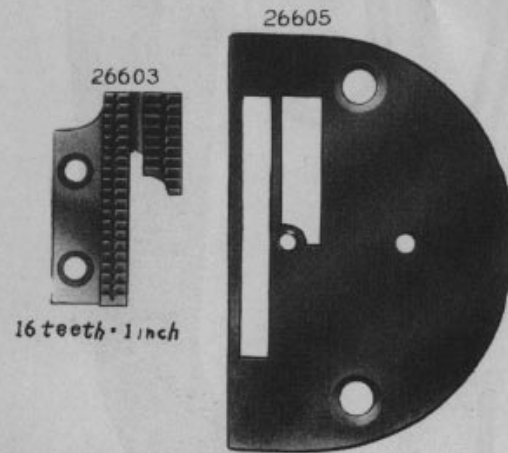
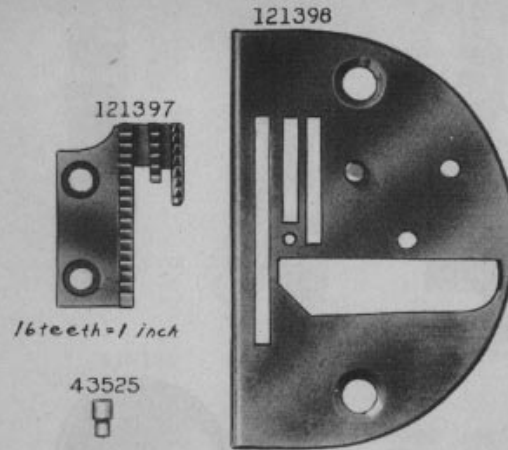


PLATE 21819—FULL SIZE

121169



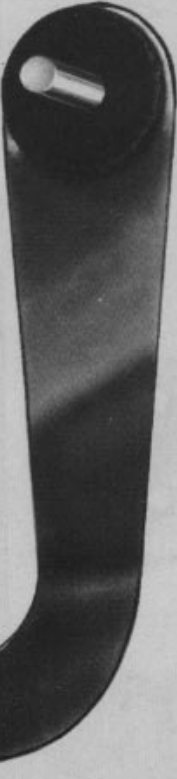
52055



36773



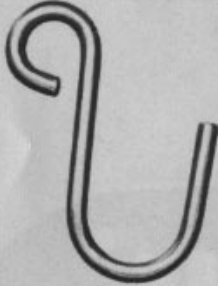
121412



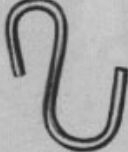
16586



56864



56865



11656



PLATE 21834—ONE-HALF SIZE

41585



41915



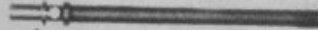
150459



41588



41586



41587



41913



41583



34105 42614 41914



PLATE 21835—ONE-HALF SIZE

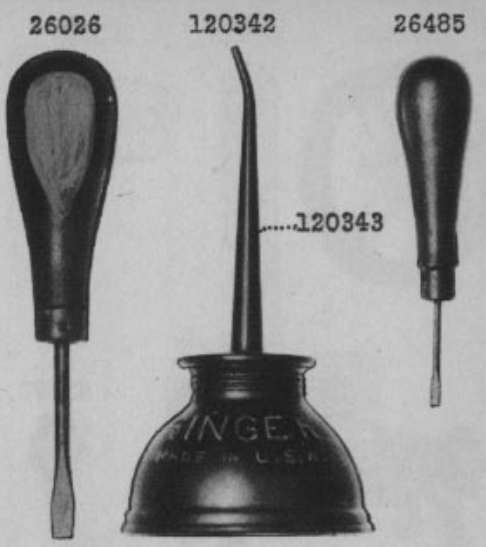


PLATE 21836 - FULL SIZE

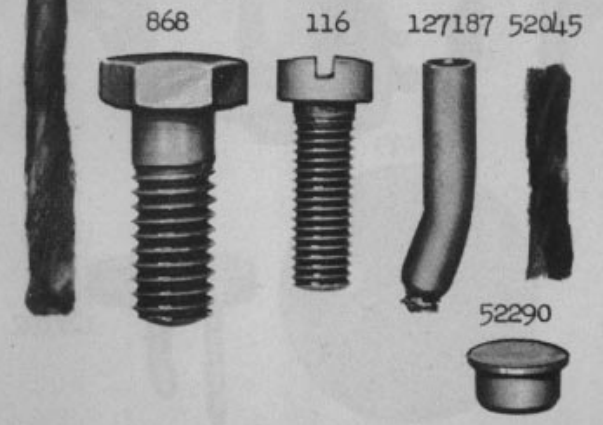
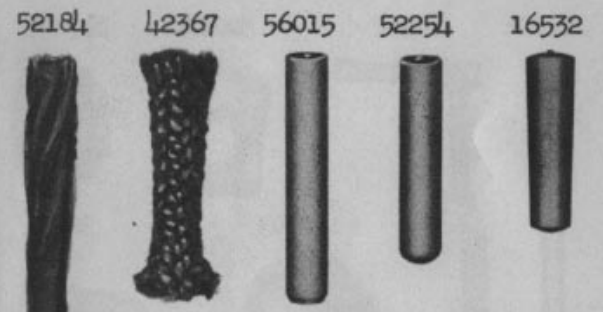
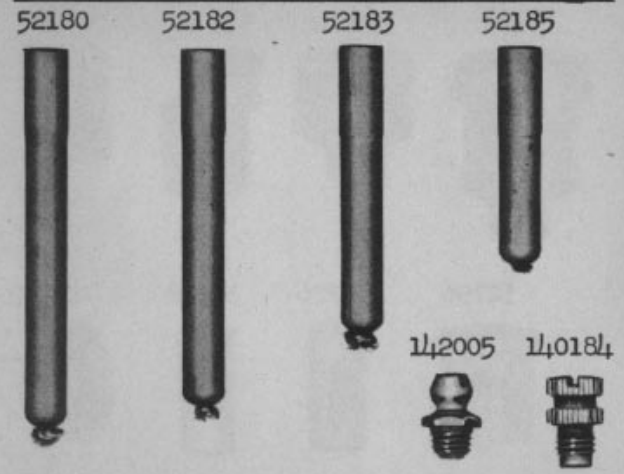


PLATE 21837 - ONE-HALF SIZE

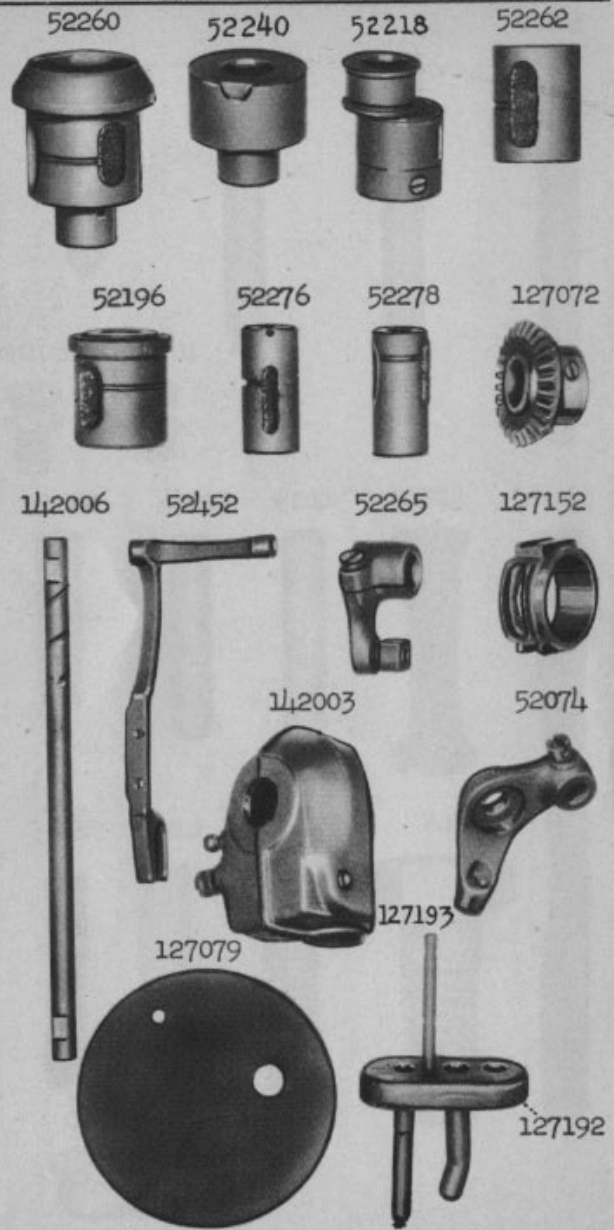


PLATE 21838 - ONE-FOURTH SIZE

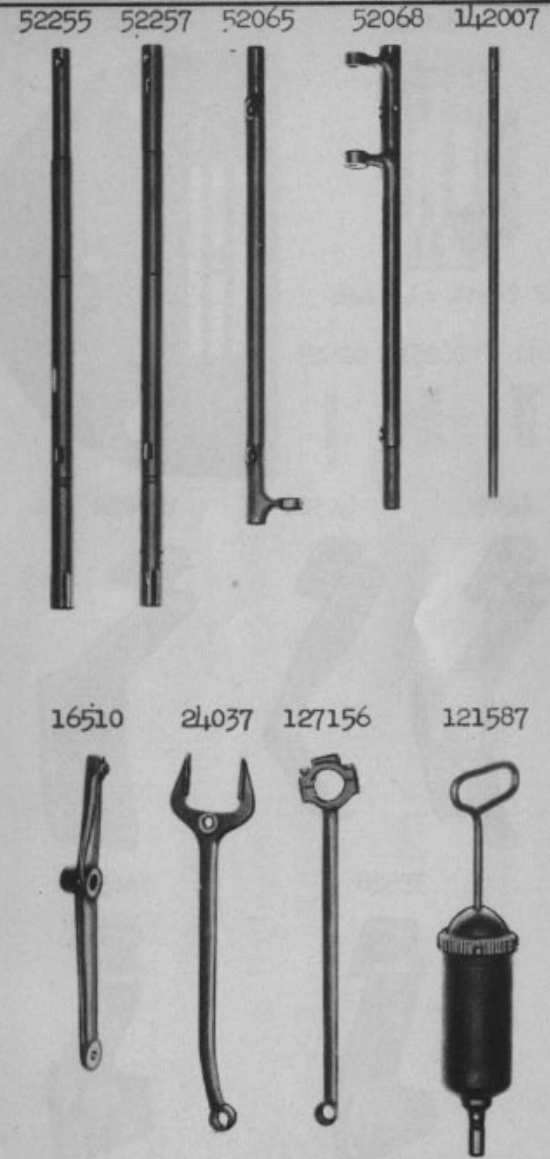
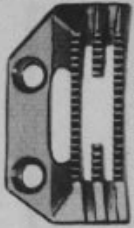
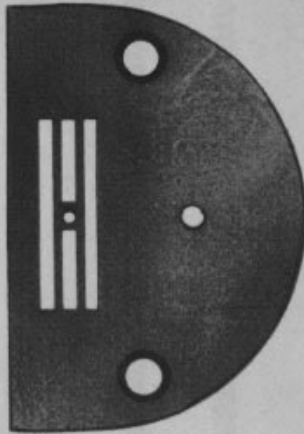


PLATE 21839 - FULL SIZE

52031



52033



22 Teeth = 1 Inch

691



26231



62527



24983



40322



120828



35528

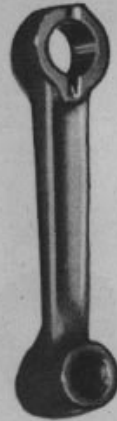


36654



PLATE 21840 - FULL SIZE

127231



688



818



52268



1133



857



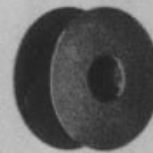
29633



127095



40264



40394



40392



1128



1065



775



24041



125320



52207



2975



PLATE 21841 - ONE-HALF SIZE

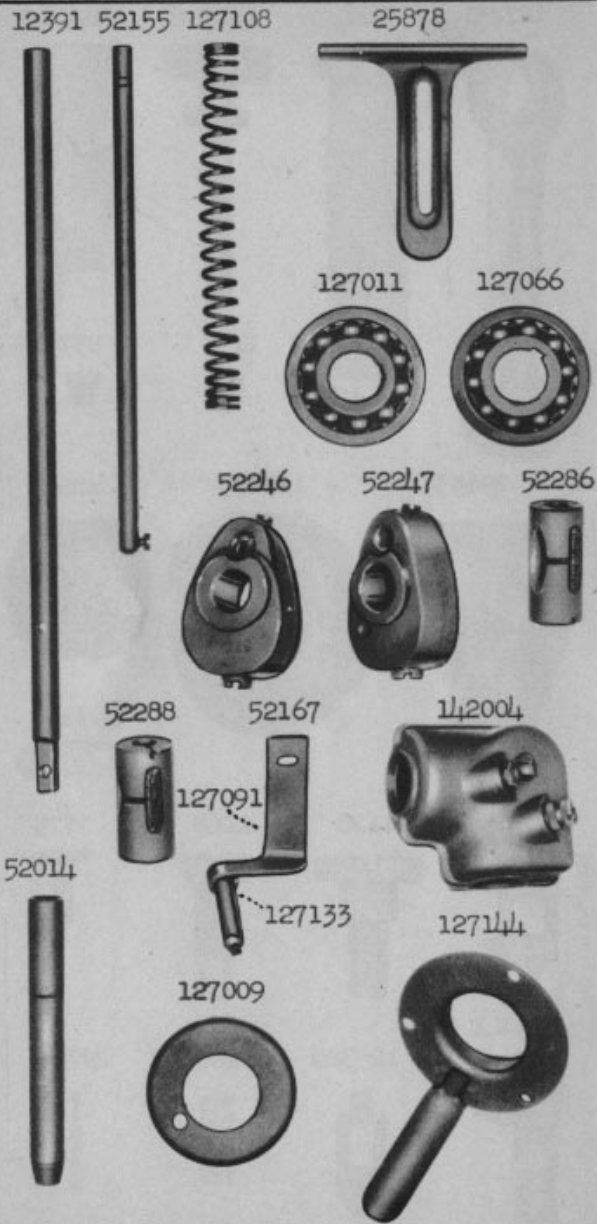


PLATE 21842 - FULL SIZE

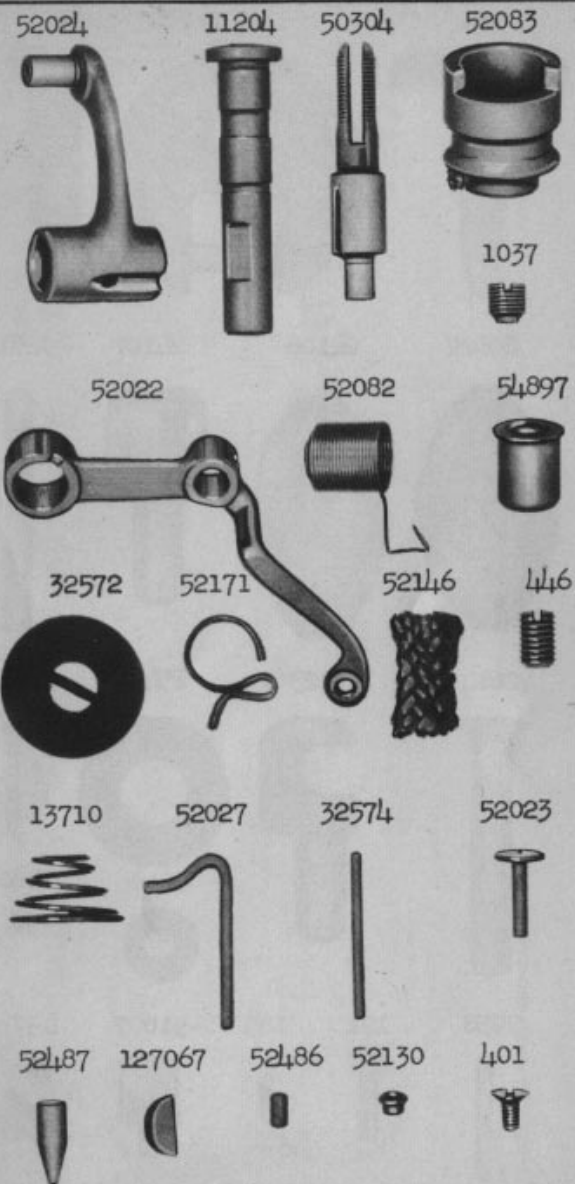


PLATE 21843 - FULL SIZE



PLATE 21844 - FULL SIZE

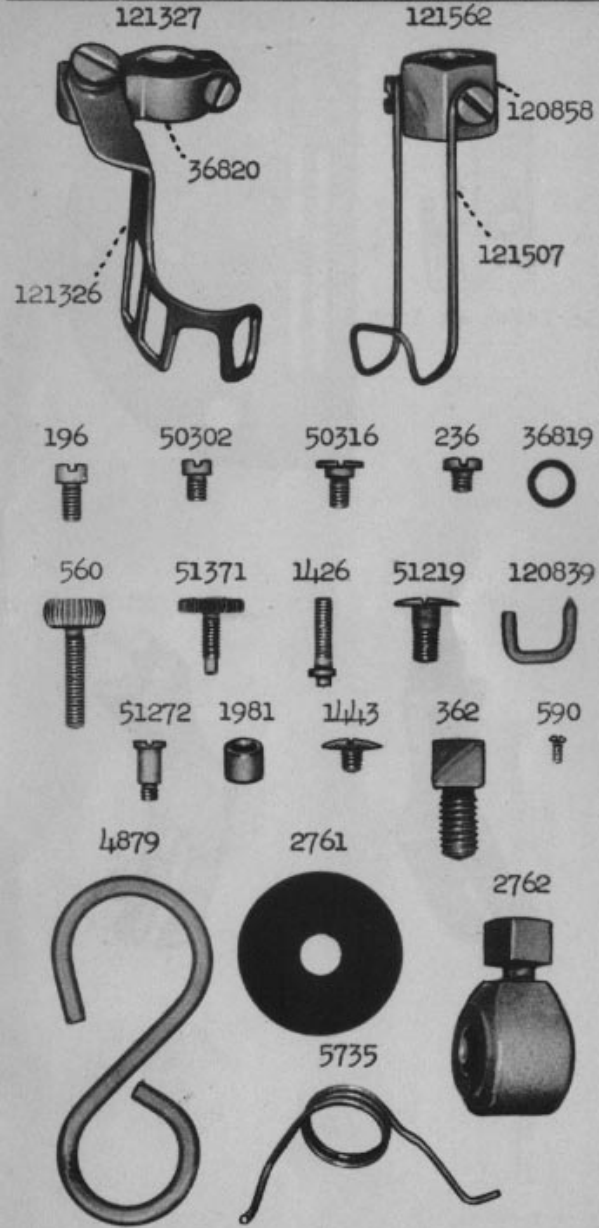
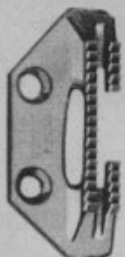


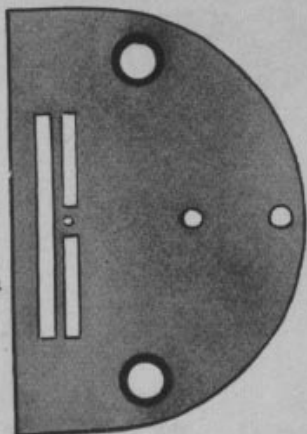
PLATE 21845 - FULL SIZE

20164

52190



16 Teeth = 1 Inch



52189



52189



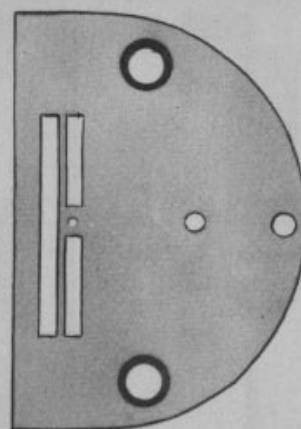
PLATE 21846 - FULL SIZE

20164

52190



16 Teeth = 1 Inch



52188

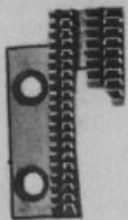


52188



PLATE 21847 - FULL SIZE

26603

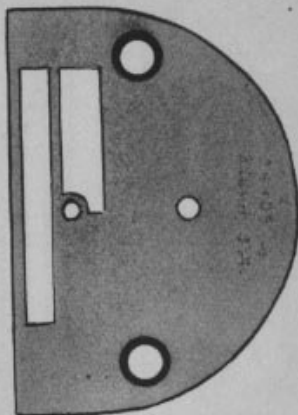


16 Teeth = 1 Inch

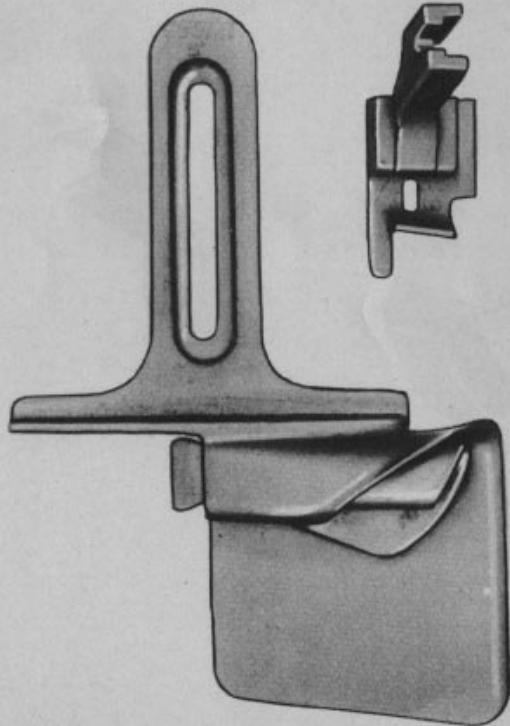
7298



26605



121653

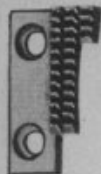


120144



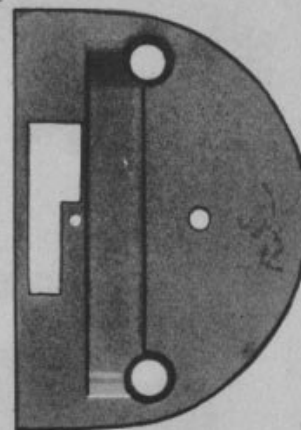
PLATE 21848 - FULL SIZE

121646



16 Teeth = 1 Inch

121649



337



121648



121647



PLATE 21849 - ONE-HALF SIZE

26603

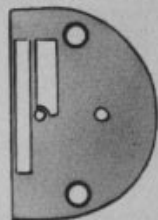


16 Teeth =
1 Inch

121656



26605



121655

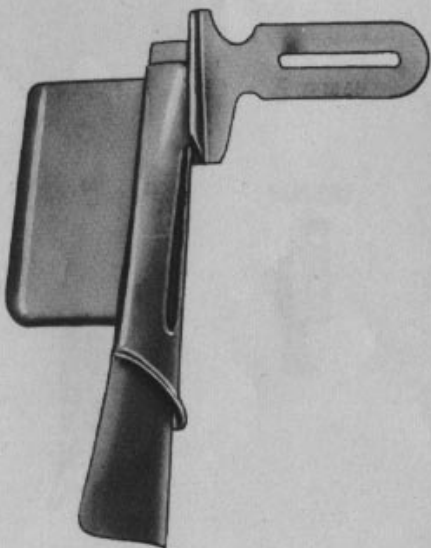
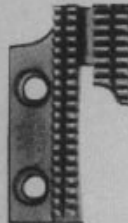


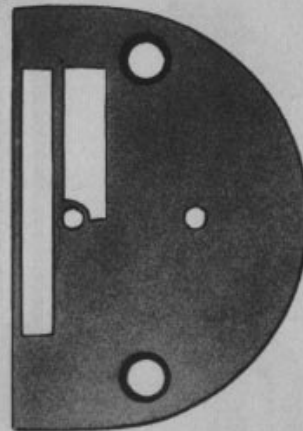
PLATE 21850 - FULL SIZE

26603

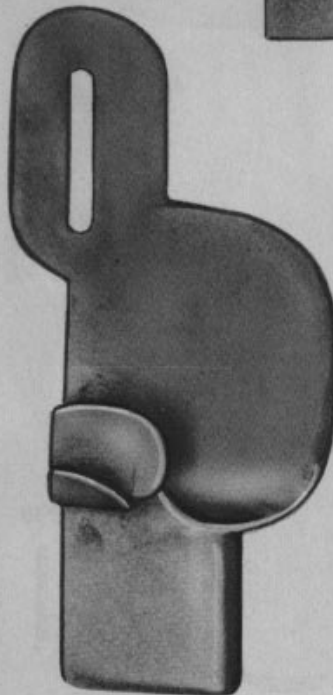


16 Teeth = 1 Inch

26605



121662

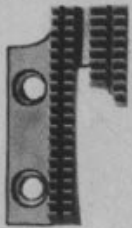


121663



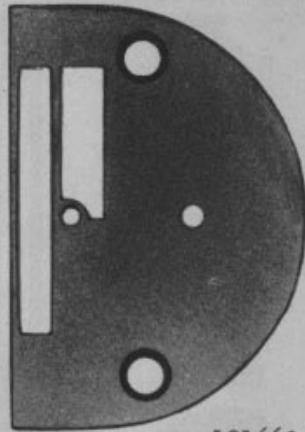
PLATE 21851 - FULL SIZE

26603



16 Teeth =
1 Inch
121658

26605



121660

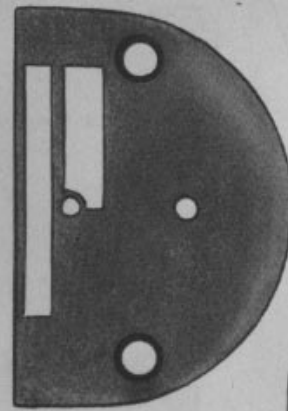


7298

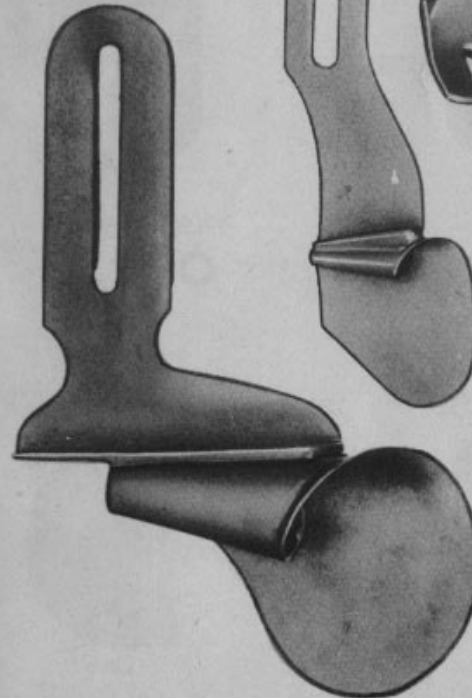


PLATE 21852 - FULL SIZE

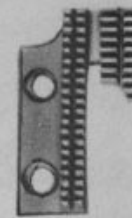
26605



28627



26603



16 Teeth = 1 Inch

120991

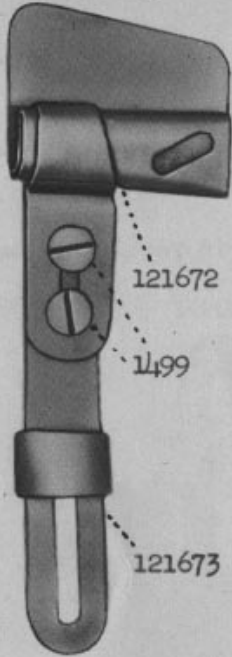


28628

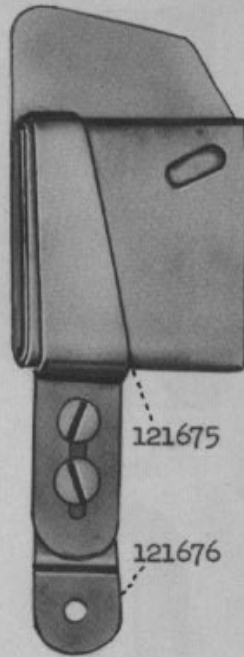


PLATE 21853 - ONE-HALF SIZE

121674



121677



121672

1499

121673

121675

121676

24



121678



39026



35522



52031



22 Teeth =
1 Inch

121680



52032

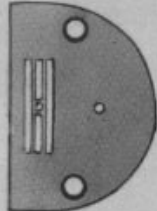
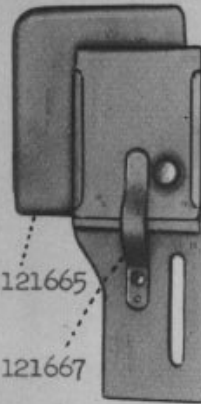


PLATE 21854 - ONE-HALF SIZE

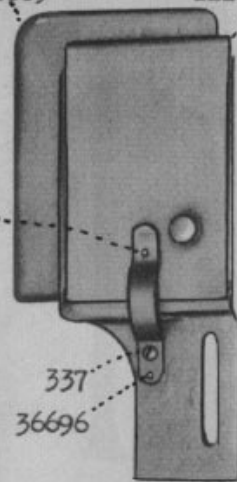
121668



121665

121667

121669



121671

121670

43525

121666

337

36696

26603



16 Teeth =
1 Inch

35063



26605

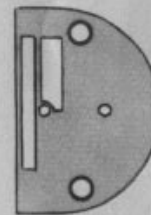


PLATE 22218 - FULL SIZE

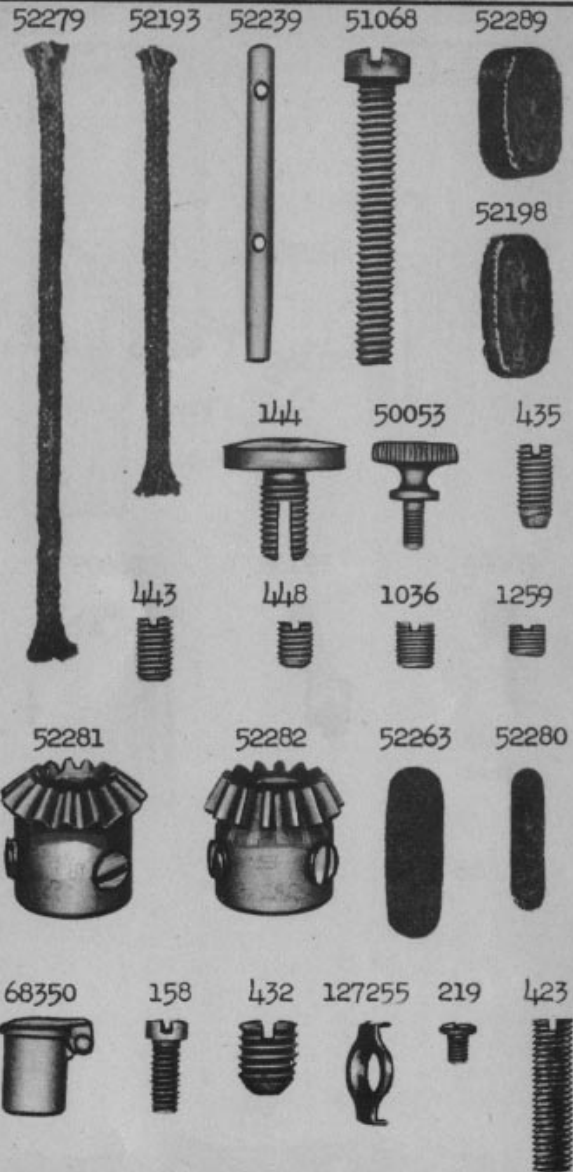


PLATE 22220 - FULL SIZE



PLATE 22224 - FULL SIZE

52018



127242



52237



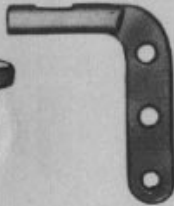
40274



52216



52454



127102



127073



1148



704



142008



1560



1253



624



50305



2974



1053



1367



1380



591

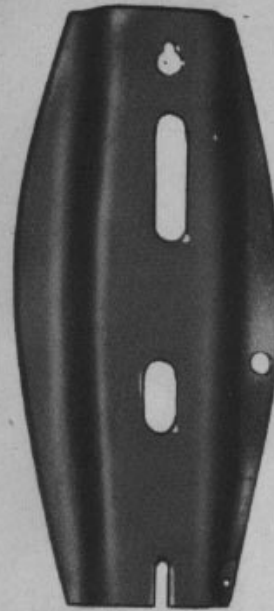


592



PLATE 22226 - ONE-HALF SIZE

52051



52176



5598



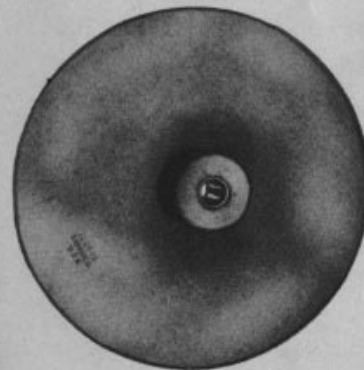
5599

52028

5596



120536



41400



PLATE 22228 - FULL SIZE

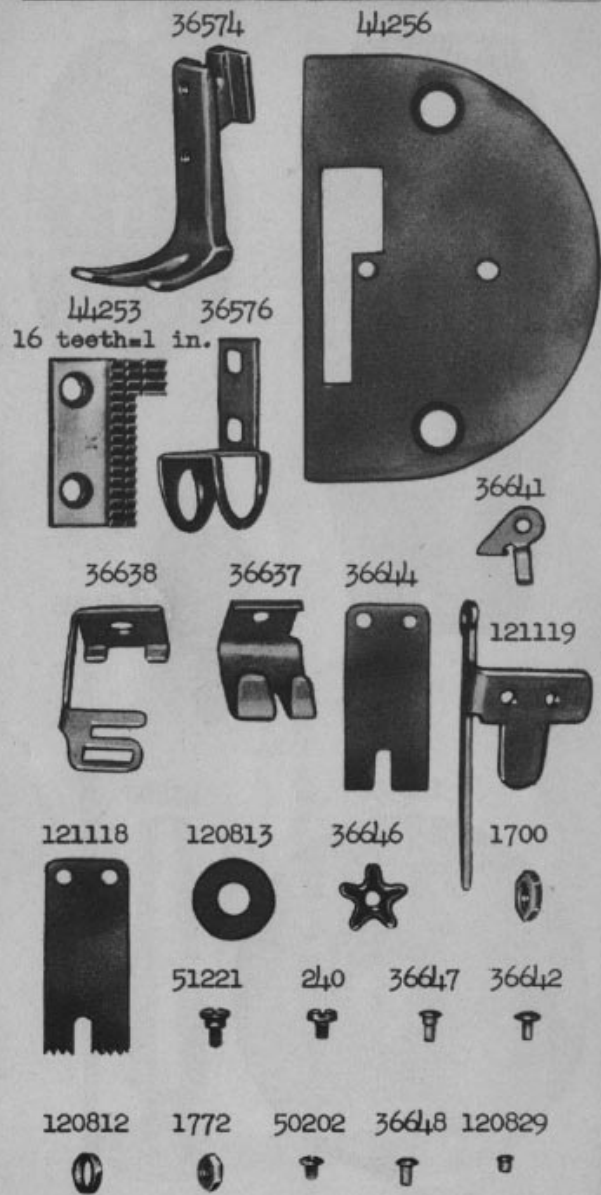


PLATE 22229 - FULL SIZE

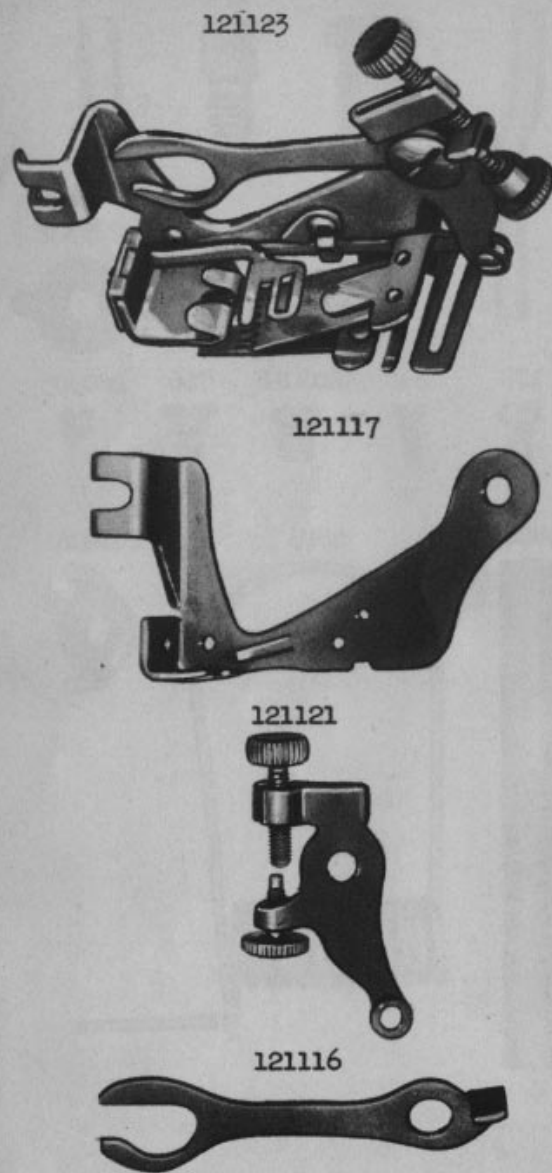


PLATE 22230 - FULL SIZE

12240



802



356



5601



76



225322

1521



178



208



201018



766



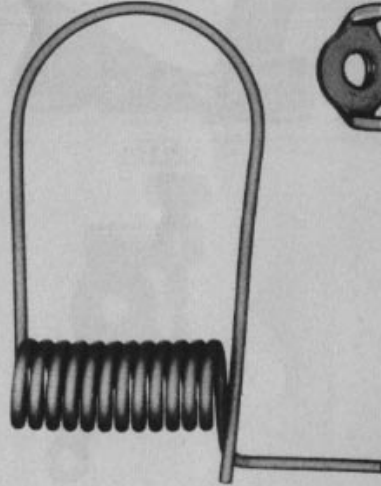
200383



4882



4883



201696

