

Singer 97-1  
Singer 97-2  
Singer 97-3  
Singer 97-4  
Singer 97-5  
Singer 97-6  
Singer 97-7  
Singer 97-8  
Singer 97-9  
Singer 97-10

Form 18301, Revised  
(640)  
Printed in U. S. A.

# LIST OF PARTS



## SINGER\*\* MACHINES

Nos. 97-1 to 97-10

---

THE SINGER MANUFACTURING COMPANY

\*\*A Trade Mark of THE SINGER MANUFACTURING COMPANY

## INSTRUCTIONS FOR OILING

To ensure easy running and prevent unnecessary wear of the parts which are in movable contact, the machine requires oiling and when in continuous use, "TYPE B" or "TYPE D" OIL, sold by Singer Sewing Machine Company, should be applied at least twice each day to all oil holes marked "OIL", as instructed in Form 8348.

"TYPE D" OIL should be used when an oil is desired which will produce a minimum of stain on fabrics, even after a long period of storage.

The shuttle race should be kept wet with oil.

Copyright, U. S. A., 1916, 1922 and 1928  
by The Singer Manufacturing Company  
All Rights Reserved for all Countries

## INDEX

	Page
Accessories.....	29
Bobbin Winder.....	29
Bobbin Winder (Electrically Heated).....	30
Column Stand No. 25274.....	34
"    "    No. 25275.....	36
"    "    No. 25276.....	39
Electric Heating Attachment.....	33
Foot Lifter Parts for Nos. 97-1 and 97-6 Machines.....	41
"    "    "    "    Nos. 25274 to 25276.....	42
Iron Base.....	29
Machine No. 97-1.....	7
"    No. 97-2.....	17
"    No. 97-3.....	17
"    No. 97-4.....	17
"    No. 97-5.....	17
"    No. 97-6.....	18
"    No. 97-7.....	28
"    No. 97-8.....	28
"    No. 97-9.....	28
"    No. 97-10.....	28
Numerical List of Parts.....	49
Obsolete Parts.....	47
Thread Unwinder for Nos. 97-1 and 97-6 Machines.....	43
"    "    "    Nos. 97-2 to 97-5 and 97-7 to 97-10	43
Machines.....	43
Under Driver for Nos. 97-1 and 97-6 Machines.....	44

## INSTRUCTIONS FOR ORDERING

In ordering from this list, use **ONLY** the part **NUMBER** in the **FIRST** Column.

The number stamped on a Sewing Machine Part is in every case the number of the single part only.

Every combination of parts sent out as such has its specific number, which, although not stamped on the parts, must be used when ordering the combination.

Each number always indicates the **SAME PART** in whatever list it appears, or for whatever machine.

The letters after some of the numbers indicate the style of finish only, as follows:

- A-Hardened, Polished, Nickel Plated and Buffed.
- A.A-Buffered and Chromium Plated.
- A.B-Hardened, Polished, Buffed and Chromium Plated.
- A.C-Brown Baking Enamel Finish.
- A.D-Gray Baking Enamel Finish.
- A.E-Hardened, Bright Rumbled and Nickel Plated.
- A.F-Hardened, Bright Rumbled, Nickel Plated, Bright Rumbled and Chromium Plated.
- A.G-Alumilite, Plain.
- A.H-Alumilite Dyed.
- A.J-Polished, Nickel Plated and Chromium Plated.
- A.K-Hardened, Polished, Nickel Plated and Chromium Plated.
- A.L-Heat Treated for Toughness.
- B-Polished, Nickel Plated and Buffed.
- C-Hardened only.
- C.R-Hardened and Merlized.
- D-Polished Only.
- E-Soft, Not Polished.
- F-Hardened and Polished.
- F.J-Hardened, Polished and Nickel Plated.
- G-Bright Rumbled and Nickel Plated.
- H-Blued.
- J-Nickel Plated Only.
- K-Hardened and Nickel Plated.
- L-Brass Plated.
- M-Oxidized.
- N-Japanned, Dull.

## INSTRUCTIONS FOR ORDERING - Continued

- P-Japanned, Bright.
- P.P-Wrinkle Finish.
- R-Merlized.
- S-Cadmium Plated.
- T-Copper Plated.
- T.A-Hardened, Polished, Copper and Nickel Plated and Buffed.
- T.B-Copper and Nickel Plated and Polished.
- T.J-Copper and Nickel Plated Only.
- T.K-Hardened, Copper and Nickel Plated.
- T.L-Copper and Brass Plated.
- T.M-Copper Plated and Oxidized.
- U-Zinc Plated.
- V-Silver Plated.
- W-Polished and Nickel Plated.
- X-Black Oxide, for Iron and Steel.
- X.C-Hardened and Black Oxide, for Iron and Steel.
- Y-Black Nickel Plated Only.
- Z-Chromium Plated.
- Z.A-Hardened, Polished, Nickel Plated, Buffed and Chromium Plated.
- Z.B-Polished, Nickel Plated, Buffed and Chromium Plated.
- Z.C-Hardened and Chromium Plated.
- Z.D-Polished and Chromium Plated.
- Z.G-Bright Rumbled, Nickel Plated, Bright Rumbled and Chromium Plated.
- Z.J-Nickel and Chromium Plated.
- Z.T-Copper and Chromium Plated.

These letters **MUST BE USED** when they appear in the list; and **AFTER** the number as in the list.

In this series:

- 1 to 1500, 50001 to 51500 and 140001 to 142000 are Screw Numbers.
- 1501 to 1800 and 51501 to 51800 are Nut Numbers.
- 1801 to 2000 and 51801 to 52000 are Roller Numbers.
- 2001 to 50000 and 52001 to 140000 and 142001 to 190000 are Sewing Machine Parts, 190001 and upward are numbers of Electrical Parts.

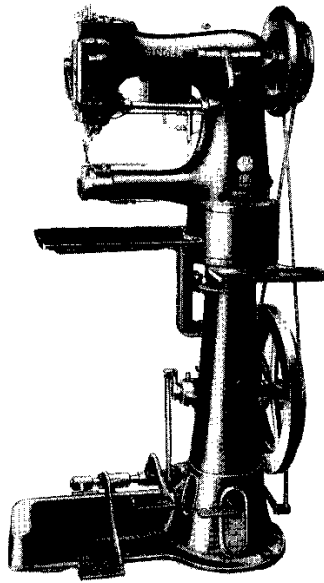
The figures in the second column refer only to the plates, illustrating the parts, and are **NOT TO BE USED** in ordering.

Parts marked with an asterisk (\*) are furnished only when repairs are made at factory.

LIST OF PARTS COMPLETE  
FOR

MACHINE No. 97-1

FOR GENERAL WORK ON HARNESS AND OTHER HEAVY LEATHER. HAS CYLINDER BED WITH CLEAR WORKING SPACE OF 11 INCHES AT THE RIGHT OF THE NEEDLE, GAS HEATING DEVICE FOR HEATING THE WAX. PARALLEL NEEDLE FEED DRIVEN BY LINK MOTION. CYLINDER SHUTTLE. WILL STITCH FROM LIGHT TO HEAVY MATERIAL WITHOUT ALTERATION IN ADJUSTMENT. FOOT LIFTER. 400 R. P. M.



MACHINE NO. 97-7 ON STAND NO. 25274  
FOR FOOT POWER

No.	Plate	Name
*58701	-----	Arm and Cylinder.....
58702	9252	" Front Cover.....
866D	9285	" " " Screw.....
58703	9270	" " " Spring.....
690D	9284	" " " " Screw.....
58704	9270	" Oil Tube, for intermediate bearing..
58954	9251	" Shaft.....
58706	9253	" " Bushing (intermediate).....
858C	3841	" " " " Set Screw
58707	9251	" " Flanged Bushing (back).....
1396D	9284	" " " " " Screw..
58708	9253	" " " " (front).....
858C	3841	" " " " " Set Screw
50262D	9272	" " Screw.....
16036	9253	" Side Cover.....
51224J	-----	" " " Thumb Screw.....
58709	9281	Balance Wheel with two 344C.....
344C	9285	" " " Set Screw.....
58710	9251	Crank Connecting Rod with two 129E.....
129E	9284	" " " Cap Screw.....
604C	9285	" " " Hinge Screw.....
1513J	3841	" " " " " Nut....
58712	9252	Face Plate.....
1186D	9284	" " " Screw (lower) left.....
1177D	9284	" " " " right.....
1177D	9284	" " " (upper).....
58713	9253	Feed Cam (double) with two 858C.....
858C	3841	" " " Set Screw.....

No.	Plate	Name
58958	9252	Feed Regulator with 1065C, 1662C and 50263C.....
50263C	9284	Feed Regulator Adjusting Screw.....
1662C	----	" " " " Nut.....
50264C	9285	" " " " Stud.....
1513J	9284	" " " " Nut.....
58715	9270	" " " " Washer
58716	9270	" " " " Sleeve....
58717	9253	" " " " Connection.....
604C	9285	" " " " Hinge Screw...
1396D	9284	" " " " " " " "
		Clamping Screw.....
1065C	9284	Feed Regulator Position Screw.....
58718	9253	" " " " Shaft.....
58719	9270	" " " " Collar with two 858C.....
858C	3841	Feed Regulator Shaft Collar Set Screw...
58720	9251	" " " " Shaft.....
58721	9270	" " " " Collar (back) with two 858C..
858C	9270	" " " " " " Set Screw.....
58722	9270	" " " " (front) with two 858C.
858C	9270	" " " " " " Set Screw.....
58723	9253	" " " " Crank (back) with four 1396D.
1396D	9284	" " " " " " Clamping Screw..
58868	9270	" " " " " " Key.....
58724	9253	" " " " (front) with 858C and 1396D.....
8873	9270	Feed Shaft Crank (front) Pin.....
1396D	9284	" " " " " " Clamping Screw.
858C	9270	" " " " " " Set Screw.....
58866	9255	Flame Protector.....
210D	9284	" " " " " " Screw.....
58852	9255	Gas Burner with 58848.....
58853	-----	" " " " 58852 with 58849.....
58848	9255	" " " " Pin.....
58854	9256	" " " " Pipe with 58859, for 58786...
58855	9256	" " " " " " 58859, for 58796...
58856	9255	" " " " " " 58859, for 58816...
58857	9256	" " " " " " Bracket.....
1186D	9284	" " " " " " Screw.....
58858	9255	" " " " " " Coupling.....
58859	9255	" " " " " " Sleeve.....
58849	9255	" " " " " " Regulator.....
58860	9256	" " " " " " Pipe.....
58861	9255	" " " " " " Elbow.....
58862	9255	" " " " " " Nipple.....
58863	9255	" " " " " " Valve with 58864.....
58864	9255	" " " " " " Handle.....
1654C	9284	" " " " " " Lock Nut.....
1741C	9284	" " " " " " Nut.....

No.	Plate	Name
58865	-----	Gas (artificial) Heating Attachment complete, Nos. 58854 to 58857, 58860 to 58862, 58866, 58867, two each 210D, 1186D and three each 1654C, 1741C, 58853, 58858 and 58863.....
36221	9262	Guide, 1 1/4 in. face.....
36891	9262	" " 1 1/2 in. face.....
871D	9262	" " Thumb Screw.....
58867	9256	Heating Plate.....
210D	9284	" " " " Screw.....
58725	9258	Needle Bar (hollow) with 58755.....
58964	9258	" " " " with 58755, for No. 31 needle
58727	-----	" " " " Connecting Link with 2117, 58731 and 58732.....
*58988	-----	Needle Bar Connecting Link complete, Nos. 58727 and 58729.....
58728	9258	Needle Bar Connecting Link Crank (inside) with 1186C.....
1186C	9284	Needle Bar Connecting Link Crank (inside) Clamping Screw.....
50265C	9284	Needle Bar Connecting Link Crank (inside) Hinge Screw.....
1736C	9284	Needle Bar Connecting Link Crank (inside) Hinge Screw Nut.....
58729	9258	Needle Bar Connecting Link Crank (outside).....
50265C	9284	Needle Bar Connecting Link Crank (outside) Hinge Screw.....
1736C	9284	Needle Bar Connecting Link Crank (outside) Hinge Screw Nut.....
*58731	9270	Needle Bar Connecting Link Extension....
58732	9270	" " " " " " Dowel Pin.....
50266C	9285	Needle Bar Connecting Link Extension Hinge Screw.....
2117	9255	Needle Bar Connecting Link Extension Pin
58733	9262	" " " " " " Stud with two 1186C
964F	9284	" " " " " " Cap Screw.....
1186D	9284	" " " " " " Clamping Screw
58734	9251	" " " " " " Frame.....
58735	9258	" " " " " " Connection with 50267C.
50267C	9284	" " " " " " Adjusting Screw
58736	9254	" " " " " " Arm.....
14C	9272	" " " " " " Hinge Screw
50268C	9285	" " " " " " Hinge Screw....
1619E	9284	" " " " " " " " Nut
58737	9255	" " " " " " Slide Block....
378C	9285	" " " " " " " " Hinge Screw.....
1520E	9284	Needle Bar Frame Connection Slide Block Hinge Screw Nut.....

No.	Plate	Name
604C	9285	Needle Bar Frame Hinge Screw.....
1396C	9284	" " " " " Clamping Screw.....
58738	9258	Needle Bar Spring.....
58739	9255	" Clamp with 50289F.....
50289F	9255	" " Screw.....
58869	9260	" Guide (lower) for No. 23 needle..
58870	-----	" " " " No. 24 needle..
58871	-----	" " " " No. 25 needle..
58872	-----	" " " " No. 26 needle..
58740	-----	" " " " No. 27 needle..
58873	-----	" " " " No. 28 needle..
58967	-----	" " " " No. 29 needle..
58969	-----	" " " " No. 30 needle..
58965	-----	" " " " No. 31 needle..
58741	9251	" " " " Rock Shaft.....
58742	9254	" " " " Back Bear- ing Oil Tube.....
58743	9274	Needle Guide (lower) Rock Shaft Crank with two 1396D.....
1396D	9284	Needle Guide (lower) Rock Shaft Crank Clamping Screw.....
58744	9257	Needle Guide (lower) Rock Shaft Crank Connecting Rod.....
908C	9285	Needle Guide (lower) Rock Shaft Crank Connecting Rod Hinge Screw (lower)..
1396D	9284	Needle Guide (lower) Rock Shaft Crank Connecting Rod Hinge Screw (lower) Clamping Screw.....
961C	9285	Needle Guide (lower) Rock Shaft Crank Connecting Rod Hinge Screw (upper)..
1396D	9284	Needle Guide (lower) Rock Shaft Crank Connecting Rod Hinge Screw (upper) Clamping Screw.....
3012	9254	Needle Guide (lower) Rock Shaft Crank Pin.....
58745	9254	Needle Guide (lower) Rock Shaft Front Bearing Oil Tube.....
1177D	9284	Needle Guide (lower) Screw.....
58874	9260	" " (upper) with 1186C, for No. 23 needle.....
58875	-----	Needle Guide (upper) with 1186C, for No. 24 needle.....
58876	-----	Needle Guide (upper) with 1186C, for No. 25 needle.....
58877	-----	Needle Guide (upper) with 1186C, for No. 26 needle.....
58746	-----	Needle Guide (upper) with 1186C, for No. 27 needle.....
58878	-----	Needle Guide (upper) with 1186C, for No. 28 needle.....

No.	Plate	Name
58968	-----	Needle Guide (upper) with 1186C, for No. 29 needle.....
58970	-----	Needle Guide (upper) with 1186C, for No. 30 needle.....
58966	-----	Needle Guide (upper) with 1186C, for No. 31 needle.....
58747	9258	Needle Guide (upper) Bar.....
58959	9257	" " " " Bracket with two 1177C.....
1177C	9284	Needle Guide (upper) Bar Bracket Clamp- ing Screw.....
58749	9254	Needle Guide (upper) Bar Bracket Cushion
58961	9254	" " " " " Slide Block.....
58751	9254	Needle Guide (upper) Bar Bracket Slide Block Cushion.....
181D	9284	Needle Guide (upper) Bar Bracket Slide Block Cushion Screw.....
1186C	9284	Needle Guide (upper) Clamping Screw....
58752	8206	" Plate (wide) medium needle hole..
58753	-----	" " " " small needle hole...
58945	9260	" " " " for edge stitching hand bags.....
58892	9261	Needle Plate (narrow) large needle hole, for leather bags, suit cases, etc...
58921	-----	Needle Plate (large needle hole).....
58922	9260	" " (raised at needle hole)....
58923	9261	" " (short end).....
58924	9260	" " (thick).....
58962	-----	" " (large needle hole) 3 stitches to the inch.....
114D	9284	Needle Plate Clamping Screw.....
58754	9257	" " Holder with 114D.....
313C	9285	" " " " Set Screw.....
58755	9262	" Stop Pin.....
58757	-----	Oscillating Rock Shaft complete, Nos. 11165 and 58758.....
58758	9257	Oscillating Rock Shaft Hinge Pin.....
1508E	9284	" " " " " Nut....
622C	9285	" " " " " Screw Bushings.....
1508E	9284	Oscillating Rock Shaft Hinge Pin Screw Bushings Nut.....
11165	9262	Oscillating Rock Shaft Oil Pad.....
58759	9254	" " " " " Tube.....
58760	9251	" Shaft.....
58742	9254	" " Back Bearing Oil Tube.
58761	9254	" " Crank.....
58762	-----	Oscillating Shaft Crank complete, Nos. 1396D, 5868, 58761 and two 1177D....

No.	Plate	Name
1177D	9284	Oscillating Shaft Crank Clamping Screw..
58820	9254	" " " Key.....
9119	9254	" " " Slide Block....
5868	-----	Oscillating Shaft Crank Slide Block complete, Nos. 190E, 1054C, 5968 and 9119
190E	9284	Oscillating Shaft Crank Slide Block Cap Screw.....
5968	9254	Oscillating Shaft Crank Slide Block Cap Screw Washer.....
1054C	9285	Oscillating Shaft Crank Slide Block Screw Stud.....
1396D	9284	Oscillating Shaft Crank Slide Block Screw Stud Clamping Screw.....
58745	9254	Oscillating Shaft Front Bearing Oil Tube
58764	9251	Presser Bar.....
58927	9259	" " Clutch with 457C and 1342E..
58990	-----	" " " 58927 with 1354C, 1467H, 1520E, 58766, 58768 and 58928.....
58766	9259	Presser Bar Clutch Clamp.....
1354C	9285	" " " " Adjusting Screw
1520E	9284	" " " " " " Nut.....
1467H	9284	Presser Bar Clutch Clamp Cap Screw.....
58767	9259	" " " Cushion.....
58768	9259	" " " Lever.....
58928	9259	" " " Hinge Pin.....
457C	9259	" " " " " " Set Screw.....
58769	9259	Presser Bar Clutch Lifting Lever.....
866C	9285	" " " " " Hinge Screw.....
58770	9259	Presser Bar Clutch Lifting Stud with 428C and 51805.....
51805	9259	Presser Bar Clutch Lifting Stud Roller..
428C	9259	" " " " " " Screw.....
58948	9263	Presser Bar Clutch Spring.....
58949	9263	" " " " Bracket with 58950.....
134E	-----	Presser Bar Clutch Spring Bracket Screw.
1029F	9284	" " " " " Screw.....
1342E	9285	" " " " " Stud....
58950	9259	" " " " " Stud.....
58772	9263	" " " Guide Bracket with two 1396D
1396D	9284	" " " " " Clamping Screw
58773	9263	" " " " " Guide Stud....
1396D	9284	" " " " " Clamping Screw.....
58989	-----	Presser Bar Guide Bracket Spacing Washer
58774	9275	" " Spring (flat) long.....

No.	Plate	Name
58775	9275	Presser Bar Spring (flat) short.....
58836	9263	" " " Bracket with 858C and two 1396D.....
1396D	9284	Presser Bar Spring Bracket Clamping Screw.....
58777	9263	Presser Bar Spring Bracket Extension....
858C	9270	" " " " " Set Screw....
58778	9263	" " " " Guide.....
21346	9259	" " " " Stud.....
58957	9264	" Foot (stitch set) 3 stitches to the inch.....
58963	9264	Presser Foot (double toe) 3 stitches to the inch.....
58887	8206	Presser Foot (double toe).....
58952	9264	" " (stitch set) 4 stitches to the inch.....
58879	9264	Presser Foot (stitch set) 5 stitches to the inch.....
58780	9264	Presser Foot (stitch set) 6 stitches to the inch.....
58880	9264	Presser Foot (stitch set) 7 stitches to the inch.....
58881	9264	Presser Foot (stitch set) 8 stitches to the inch.....
58882	9265	Presser Foot (stitch set) 9 stitches to the inch.....
58883	9265	Presser Foot (stitch set) 10 stitches to the inch.....
58884	9265	Presser Foot (stitch set) 11 stitches to the inch.....
58885	9265	Presser Foot (stitch set) 12 stitches to the inch.....
58946	9265	Presser Foot for edge stitching hand bags.....
58889	9264	Presser Foot (closed toe).....
58929	9265	" " (toe at left of needle)....
58930	9265	" " (toe at right of needle)...
58931	9265	" " (toe at left and front of needle).....
58781	9266	Presser Foot Holder with 1177D.....
1177D	9284	" " " Clamping Screw.....
162D	-----	" " " Screw.....
609D	9285	Pressure Regulating Thumb Screw.....
11910	9266	Shuttle Bobbin.....
58782	9266	" Cylinder.....
*58890	-----	" " 58782 with 773F and 58785
58527	-----	" " Hinge Pin.....
58626	-----	" " Latch.....
12002	9266	" " " Pin.....
19869	9254	" " " Spring.....



## PARTS FOR MACHINE No. 97-1

No.	Plate	Name
58784	9267	Shuttle Frame.....
58891	-----	" " 58784 with 12002,19869 and 58626.....
773F	9285	Shuttle Tension Regulating Screw.....
58785	9266	" " Spring.....
58786	9267	Shuttle (cylinder) 3 in. diam. complete, Nos. 11910, 58527, 58890 and 58891..
58787	9258	Shuttle Driver with 453C.....
2117	9255	" " Pin.....
453C	9254	" " Set Screw.....
*58788	9268	" Race with 1019C.....
58789	9269	" " Cover.....
55612	9266	" " Hinge Pin.....
50270C	9266	" " Lock Screw.....
58791	9269	" " Ring.....
58792	9266	" " Steady Pin.....
26D	9285	" " Screw.....
1019C	-----	" " Set Screw.....
58793	9266	" " Spring.....
58794	-----	Shuttle Race complete, Nos. 55612,58788, 58789 and two each 26D, 50270C and 58793.....
11241	9271	Tension Friction Washer (felt).....
19684	9271	" " " (steel).....
1535E	9271	" Regulating Thumb Nut.....
8787	9271	" " " Washer.....
50271C	9271	" Screw Stud.....
430C	9271	" " " Set Screw.....
19686	9271	" Spring.....
58795	9271	" Wheel.....
58796	-----	Tension (wheel) complete, Nos. 1535E, 8787, 19684, 19686, 50271C, 58795 and two 11241.....
58797	9271	Tension Wheel Brake with 174E.....
174E	9271	" " " Adjusting Screw.....
58798	9271	" " " Connection.....
1359C	9285	" " " Hinge Screw
1597E	9284	" " " Lock Nut...
1597E	9284	" " " Nut.....
43945	9271	" " " Spring.....
1660D	9271	" " " Thumb Nut.....
996C	9271	Tension Wheel Brake Hinge Screw.....
58799	9271	" " " Bushing.
58800	9271	Thread Guide Roller (side of arm).....
58801	9271	" " " Cover.....
1042C	9285	" " " Screw.....
58802	9273	" Retainer Plate.....
90D	9285	" " " Screw.....
58803	9273	" " " Spring.....

## PARTS FOR MACHINE No. 97-1

No.	Plate	Name
140147J	-----	Thread Retainer Spring Screw.....
58955	9275	" Take-up Cam with 429C.....
8983	9273	" " " Pin.....
429C	9285	" " " Set Screw.....
58942	9273	" " " Support.....
896E	9284	" " " Screw.....
58805	9274	" " Lever.....
58806	-----	Thread Take-up Lever complete, Nos.51806, 58801,58805,58807 and two each 1042C and 58800.....
50273C	9284	Thread Take-up Lever Hinge Screw.....
51806	9273	" " " Roller and Screw Stud with 1608C.....
1608C	9273	Thread Take-up Lever Roller and Screw Stud Nut.....
58800	9271	Thread Take-up Lever Thread Guide Roller (back).....
58801	9271	Thread Take-up Lever Thread Guide Roller (back) Cover.....
1042C	9285	Thread Take-up Lever Thread Guide Roller (back) Screw.....
58800	9271	Thread Take-up Lever Thread Guide Roller (front).....
58807	9271	Thread Take-up Lever Thread Guide Roller (front) Cover.....
1042C	9285	Thread Take-up Lever Thread Guide Roller (front) Screw.....
58886	9273	Thread Take-up Spring.....
58808	9276	Wax Box.....
1396D	9284	" " Screw.....
58809	9257	" " Tension Bracket.....
181D	9284	" " " Screw.....
2102	9273	" " Disc.....
1560C	9273	" " Regulating Thumb Nut.....
1110C	9273	" " Screw Stud.....
2103	9273	" " Spring.....
58810	9273	" " Thread Guide.....
58893	9272	" " " Roller.....
58894	9272	" " " Cover.....
50430C	9285	" " " Screw.....
58811	9272	" " " Stripper (lower).....
58812	9272	" " " Arm.....
50431	9285	" " " Hinge Screw.....
58813	9272	Wax Box Thread Stripper (lower) Arm Spring.....
199D	9284	Wax Box Thread Stripper (lower) Arm Spring Screw.....
836E	9285	Wax Box Thread Stripper (lower) Hinge Screw.....

## PARTS FOR MACHINE No. 97-1

No.	Plate	Name
58814	9272	Wax Box Thread Stripper (lower) Spring..
1423D	9284	" " " " " " " "
		Screw.....
58815	9272	Wax Box Thread Stripper (upper).....
181D	9284	" " " " " " " " Screw...
58816	-----	Wax Box complete, Nos. 199D, 836E, 1110C, 1423D, 1560C, 2103, 50431, 58808 to 58815, two 2102 and three each 181D, 50430, 58893 and 58894.....

SINGER Needles should be used  
in SINGER Machines  
These Needles and their Containers  
are marked with the  
Company's Trade Mark "SIMANCO.\*\*" 1

Needles in Containers marked  
"FOR SINGER MACHINES"  
are NOT SINGER made needles. 2

## MACHINE No. 97-2

THIS MACHINE IS THE 97-1 MACHINE  
WITH COLUMN STAND No. 25274, FOR FOOT  
POWER AND THE FOLLOWING EXCEPTION:

No.	Plate	Name
58845	9281	Balance Wheel (two speed) 6 in. and 8 in. diam., with two 344C, in place of 58709.....

## MACHINE No. 97-3

THIS MACHINE IS THE 97-1 MACHINE,  
FOR MECHANICAL POWER. COLUMN STAND  
No. 25275. COUNTERSHAFT No. 46603.  
CLEARANCE UNDER PRESSER  
FOOT 1 1/4 INCHES.

## MACHINE No. 97-4

THIS MACHINE IS THE 97-1 MACHINE,  
FOR DIRECT CURRENT ELECTRICAL POWER.  
COLUMN STAND No. 25276. CLEARANCE  
UNDER PRESSER FOOT 1 1/4 INCHES.

NOTE: ORDER MUST STATE THE NUMBER OF MOTOR  
REQUIRED, SO THAT CORRECT VOLTAGE CAN BE FURNISHED.  
SEE MOTOR SECTION, SHOWING MOTOR FOR  
CLASS 97 MOTORS IN FORM 19100.

## MACHINE No. 97-5

THIS MACHINE IS THE 97-1 MACHINE,  
FOR ALTERNATING CURRENT ELECTRICAL POWER.  
COLUMN STAND No. 25276. CLEARANCE  
UNDER PRESSER FOOT 1 1/4 INCHES.

NOTE: ORDER MUST STATE THE NUMBER OF MOTOR  
REQUIRED, SO THAT CORRECT VOLTAGE, CYCLES  
AND PHASE CAN BE FURNISHED.  
SEE MOTOR SECTION, SHOWING MOTOR FOR  
CLASS 97 MOTORS IN FORM 19100

LIST OF PARTS COMPLETE  
FOR

MACHINE No. 97-6

FOR GENERAL WORK ON HARNESS AND OTHER HEAVY LEATHER. HAS CYLINDER BED WITH WORKING SPACE OF 12 INCHES AT THE RIGHT OF THE NEEDLE; PARALLEL NEEDLE FEED DRIVEN BY LINK MOTION. THE MACHINE WILL STITCH FROM LIGHT TO HEAVY MATERIAL WITHOUT ALTERATION IN THE ADJUSTMENT AND WILL STITCH CLOSER TO DOUBLE BAR BUCKLES OR RINGS. CYLINDER SHUTTLE. GAS HEATING DEVICE FOR HOT WAX STITCHING. FOOT LIFTER. THE MACHINE CAN ALSO BE SUCCESSFULLY OPERATED WITHOUT HEATING DEVICE BY USING THE THREAD WITH ANY LUBRICATOR THAT WILL RUN COLD. 400 R. P. M.

No.	Plate	Name
*58701	-----	Arm and Cylinder.....
58896	9252	" Front Cover.....
866D	9285	" " " Screw.....
58703	9270	" " " Spring.....
690D	9284	" " " Screw.....
14129	9270	" " " Washer.....
58704	9270	" Oil Tube, for intermediate bearing..
58954	9251	" Shaft.....
58706	9253	" " Bushing (intermediate).....
858C	3841	" " " " Set Screw
58707	9251	" " Flanged Bushing (back).....
1396D	9284	" " " " " Screw..
58708	9253	" " " " (front).....
858C	3841	" " " " " Set Screw
50262D	9272	" " " " " Screw.....
16036	9253	" Side Cover.....
51224J	-----	" " " Thumb Screw.....
58709	9281	Balance Wheel with two 344C.....
344C	9285	" " " Set Screw.....
58710	9251	Crank Connecting Rod with two 129E.....
129E	9284	" " " " Cap Screw.....

No.	Plate	Name
604C	9285	Crank Connecting Rod Hinge Screw.....
1513J	9284	" " " " " Nut....
58897	9252	Face Plate.....
1394D	9284	" " " Screw (lower) left.....
1177D	9284	" " " " " right.....
1177D	9284	" " " " (upper).....
58713	9253	Feed Cam (double) with two 858C.....
858C	3841	" " " Set Screw.....
58958	9252	" Regulator with 1065C, 1662C and 50263C.....
50263C	9284	Feed Regulator Adjusting Screw.....
1662C	-----	" " " " " Nut.....
50264C	9285	" " " " Stud.....
1513J	9284	" " " " " Nut.....
58715	9270	" " " " " Washer
58716	9270	" " " " " Sleeve....
58717	9253	" " " Connection.....
604C	9285	" " " " Hinge Screw...
1396D	9284	" " " " " " "
		Clamping Screw.....
1065C	9284	Feed Regulator Position Screw.....
58718	9253	" " " Shaft.....
58719	9270	" " " " Collar with two 858C
858C	3841	" " " " " Set Screw....
58720	9251	" Shaft.....
58721	9270	" " " Collar (back) with two 858C..
858C	9270	" " " " " Set Screw.....
58722	9270	" " " " (front) with two 858C.
858C	9270	" " " " " Set Screw.....
58723	9253	" " " Crank (back) with four 1396D.
1396D	9284	" " " " " Clamping Screw..
58868	9270	" " " " " Key.....
58724	9253	" " " " (front) with 858C and 1396D.....
8873	9270	Feed Shaft Crank (front) Pin.....
1396D	9284	" " " " " Clamping Screw.
858C	9270	" " " " " Set Screw.....
58866	9255	Flame Protector.....
210D	9284	" " " " " Screw.....
58852	9255	Gas Burner with 58848.....
58853	-----	" " " 58852 with 58849.....
58848	9255	" " " Pin.....
58854	9256	" " " Pipe (brass) with 58859, for 58786.....
58855	9256	Gas Burner Pipe (brass) with 58859, for 58796.....
58856	9255	Gas Burner Pipe (brass) with 58859, for 58816.....
58857	9256	Gas Burner Pipe Bracket.....
1186D	9284	" " " " " Screw.....

## PARTS FOR MACHINE No. 97-6

No.	Plate	Name
58858	9255	Gas Burner Pipe Coupling.....
58859	9255	" " " Sleeve.....
58849	9255	" " " Regulator.....
58860	9256	" Pipe.....
58861	9255	" " Elbow.....
58862	9255	" " " Nipple.....
58863	9255	" Valve with 58864.....
58864	9255	" " Handle.....
1654C	9284	" " Lock Nut.....
1741C	9284	" " Nut.....
58953	-----	Gas (artificial) Heating Attachment complete, Nos. 58854 to 58857, 58860 to 58862, 58866, 58898, two each 210D, 1186D and three each 1654C, 1741C, 58853, 58858 and 58863.....
120104	9262	Guide, 3/4 in. face.....
36221	9262	" 1 1/4 in. face.....
36891	9262	" 1 1/2 in. face.....
671D	9262	" Thumb Screw.....
58898	9256	Heating Plate for 58796.....
210D	9284	" " Screw.....
58899	9258	Needle Bar.....
58900	-----	" " 58899 with 1186F and 58903....
58727	-----	" " Connecting Link with 2117, 58731 and 58732.....
*58988	-----	Needle Bar Connecting Link complete, Nos. 58727 and 58729.....
58728	9258	Needle Bar Connecting Link Crank (inside) with 1186C.....
1186C	9284	Needle Bar Connecting Link Crank (inside) Clamping Screw.....
50265C	9284	Needle Bar Connecting Link Crank (inside) Hinge Screw.....
1736C	9284	Needle Bar Connecting Link Crank (inside) Hinge Screw Nut.....
58729	9258	Needle Bar Connecting Link Crank (outside).....
50265C	9284	Needle Bar Connecting Link Crank (outside) Hinge Screw.....
1736C	9284	Needle Bar Connecting Link Crank (outside) Hinge Screw Nut.....
*58731	9270	Needle Bar Connecting Link Extension....
58732	9270	" " " " " Dowel Pin.....
50266C	9285	Needle Bar Connecting Link Extension Hinge Screw.....
2117	9255	Needle Bar Connecting Link Extension Pin
58901	9262	" " " Stud with two 1186D
964F	9284	" " " Cap Screw.....
1186D	9284	" " " Clamping Screw

## PARTS FOR MACHINE No. 97-6

No.	Plate	Name
58902	9251	Needle Bar Frame.....
58735	9258	" " " Connection with 50267C.
50267C	9284	" " " " Adjusting Screw
58736	9254	" " " " Arm.....
14C	9272	" " " " " Hinge Screw
50268C	9285	" " " " Hinge Screw....
1619E	9284	" " " " " Nut
58737	9255	" " " " Slide Block....
378C	9285	" " " " " Hinge Screw.....
1520E	9284	Needle Bar Frame Connection Slide Block Hinge Screw Nut.....
604C	9285	Needle Bar Frame Hinge Screw.....
1396C	9284	" " " " " Clamping Screw.....
58903	9255	Needle Clamp.....
1186F	9284	" " Screw.....
58904	9260	" Guide (lower) for No. 23 Needle..
58905	-----	" " " " No. 24 Needle..
58906	-----	" " " " No. 25 Needle..
58907	-----	" " " " No. 26 Needle..
58908	-----	" " " " No. 27 Needle..
58909	-----	" " " " No. 28 Needle..
58741	9251	" " " Rock Shaft.....
58742	9254	" " " " Back Bearing Oil Tube.....
58743	9274	Needle Guide (lower) Rock Shaft Crank with two 1396D.....
1396D	9284	Needle Guide (lower) Rock Shaft Crank Clamping Screw.....
58744	9257	Needle Guide (lower) Rock Shaft Crank Connecting Rod.....
908C	9285	Needle Guide (lower) Rock Shaft Crank Connecting Rod Hinge Screw (lower)..
1396D	9284	Needle Guide (lower) Rock Shaft Crank Connecting Rod Hinge Screw (lower) Clamping Screw.....
961C	9285	Needle Guide (lower) Rock Shaft Crank Connecting Rod Hinge Screw (upper)..
1396D	9284	Needle Guide (lower) Rock Shaft Crank Connecting Rod Hinge Screw (upper) Clamping Screw.....
3012	9254	Needle Guide (lower) Rock Shaft Crank Pin.....
58745	9254	Needle Guide (lower) Rock Shaft Front Bearing Oil Tube.....
1177D	9284	Needle Guide (lower) Screw.....
58910	9260	" " (upper) with 1186C, for No. 23 Needle.....
58911	-----	Needle Guide (upper) with 1186C, for No. 24 Needle.....

No.	Plate	Name
58912	-----	Needle Guide (upper) with 1186C, for No. 25 Needle.....
58913	-----	Needle Guide (upper) with 1186C, for No. 26 Needle.....
58914	-----	Needle Guide (upper) with 1186C, for No. 27 Needle.....
58915	-----	Needle Guide (upper) with 1186C, for No. 28 Needle.....
58916	9251	Needle Guide (upper) Bar (hollow).....
58960	9257	" " " " Bracket with two 1177C.....
1177C	9284	Needle Guide (upper) Bar Bracket Clamping Screw.....
58918	9254	Needle Guide (upper) Bar Bracket Cushion
2049	9266	" " " " " Pin....
58961	9254	" " " " " Slide Block.....
58751	9254	Needle Guide (upper) Bar Bracket Slide Block Cushion.....
181D	9284	Needle Guide (upper) Bar Bracket Slide Block Cushion Screw.....
58920	9256	Needle Guide (upper) Bar Spring.....
1186C	9284	" " " Clamping Screw....
58921	-----	" Plate (large needle hole).....
58752	8206	" " (wide) medium needle hole..
58753	-----	" " " small needle hole...
58922	9260	" " (raised at needle hole)....
58923	9261	" " (short end).....
58924	9260	" " (thick).....
58892	9261	" " (narrow) large needle hole, for leather bags, suit cases, etc...
58945	9260	Needle Plate, for edge stitching hand bags.....
58962	-----	Needle Plate (large needle hole) 3 stitches to the inch.....
114D	9284	Needle Plate Clamping Screw.....
58925	9257	" " Holder with 114D.....
313C	9285	" " " Set Screw.....
58757	-----	Oscillating Rock Shaft complete, Nos. 11165 and 58758.....
58758	9257	Oscillating Rock Shaft Hinge Pin.....
1508E	9284	" " " " " Nut....
622C	9285	" " " " " Screw Bushing.....
1508E	9284	Oscillating Rock Shaft Hinge Pin Screw Bushing Nut.....
11165	9262	Oscillating Rock Shaft Oil Pad.....
58759	9254	" " " " " Tube.....
58926	9251	" Shaft.....
58742	9254	" " Back Bearing Oil Tube.

No.	Plate	Name
11393	9254	Oscillating Shaft Collar with two 453C..
453C	9254	" " " Set Screw.....
58761	9254	" " Crank.....
58762	-----	Oscillating Shaft Crank complete, Nos. 1396D, 5868, 58761 and two 1177D....
1177D	9284	Oscillating Shaft Crank Clamping Screw..
58820	9254	" " " Key.....
9119	9254	" " " Slide Block.....
5868	-----	Oscillating Shaft Crank Slide Block complete, Nos. 190E, 1054C, 5968 and 9119
190E	9284	Oscillating Shaft Crank Slide Block Cap Screw.....
5968	9254	Oscillating Shaft Crank Slide Block Cap Screw Washer.....
1054C	9285	Oscillating Shaft Crank Slide Block Screw Stud.....
1396D	9284	Oscillating Shaft Crank Slide Block Screw Stud Clamping Screw.....
58745	9254	Oscillating Shaft Front Bearing Oil Tube
58764	9251	Presser Bar.....
58927	9259	" " Clutch with 457C and 1342E..
58990	-----	" " " 58927 with 1354C, 1467H, 1520E, 58766, 58768 and 58928.....
58766	9259	Presser Bar Clutch Clamp.....
1354C	9285	" " " " Adjusting Screw
1520E	9284	" " " " " Nut.....
1467H	9284	Presser Bar Clutch Clamp Cap Screw.....
58767	9259	" " " Cushion.....
58768	9259	" " " Lever.....
58928	9259	" " " " Hinge Pin.....
457C	9259	" " " " " Set Screw.....
58769	9259	Presser Bar Clutch Lifting Lever.....
866C	9285	" " " " " Hinge Screw.....
58770	9259	Presser Bar Clutch Lifting Stud with 428C and 51805.....
51805	9259	Presser Bar Clutch Lifting Stud Roller..
428C	9259	" " " " " Screw.....
58948	9263	Presser Bar Clutch Spring.....
58949	9263	" " " " " Bracket with 58950.....
134E	-----	Presser Bar Clutch Spring Bracket Screw.
1029F	9284	" " " " " Screw.....
1342F	9285	" " " " " Stud....
58950	9259	" " " " " Stud.....
58772	9263	" " Guide Bracket with two 1396D
1396D	9284	" " " Clamping Screw

## PARTS FOR MACHINE No. 97-6

No.	Plate	Name
58773	9263	Presser Bar Guide Bracket Guide Stud....
1396D	9284	" " " " " "
		Clamping Screw.....
58989	-----	Presser Bar Guide Bracket Spacing Washer
58774	9275	" " Spring (flat) long.....
58775	9275	" " " " short.....
58836	9263	" " " Bracket with 858C and
		two 1396D.....
1396D	9284	Presser Bar Spring Bracket Clamping
		Screw.....
58777	9263	Presser Bar Spring Bracket Extension....
858C	9270	" " " " Set Screw....
58778	9263	" " " Guide.....
21346	9259	" " " Stud.....
58957	9264	" Foot (stitch set) 3 stitches to
		the inch.....
58963	9264	Presser Foot (double toe) 3 stitches to
		the inch.....
58952	9264	Presser Foot (stitch set) 4 stitches to
		the inch.....
58879	9264	Presser Foot (stitch set) 5 stitches to
		the inch.....
58780	9264	Presser Foot (stitch set) 6 stitches to
		the inch.....
58880	9264	Presser Foot (stitch set) 7 stitches to
		the inch.....
58881	9264	Presser Foot (stitch set) 8 stitches to
		the inch.....
58882	9265	Presser Foot (stitch set) 9 stitches to
		the inch.....
58883	9265	Presser Foot (stitch set) 10 stitches to
		the inch.....
58884	9265	Presser Foot (stitch set) 11 stitches to
		the inch.....
58885	9265	Presser Foot (stitch set) 12 stitches to
		the inch.....
58887	8206	Presser Foot (double toe).....
58946	9265	" " for edge stitching hand bags
58889	9264	" " (closed toe).....
58929	9265	" " (toe at left of needle)....
58930	9265	" " (toe at right of needle)....
58931	9265	" " (toe at left and front of
		needle).....
58932	9266	Presser Foot Holder with 1177D.....
1177D	9284	" " " Clamping Screw.....
162D	-----	" " Screw.....
609D	9285	Pressure Regulating Thumb Screw.....
11910	9266	Shuttle Bobbin.....
58782	9266	" Cylinder.....
*58890	-----	" " 58782 with 773F and 58785.

## PARTS FOR MACHINE No. 97-6

No.	Plate	Name
58527	-----	Shuttle Cylinder Hinge Pin.....
58626	-----	" " Latch.....
12002	9266	" " " Pin.....
19869	9254	" " " Spring.....
58784	9267	" Frame.....
58891	-----	" " 58784 with 12002, 19869 and
		58626.....
773F	9285	Shuttle Tension Regulating Screw.....
58785	9266	" " Spring.....
58786	9267	Shuttle (cylinder) 3 in. diam. complete,
		Nos. 11910, 58527, 58890 and 58891..
58787	9258	Shuttle Driver with 453C.....
2117	9255	" " Pin.....
453C	9254	" " Set Screw.....
*58933	9268	" Race with 461C and 58947.....
58951	-----	" " 58933 with 442C, 55612, 58935,
		two each 171D, 50456C and 58936....
58934	9268	Shuttle Race Back with 2049.....
2049	9266	" " " Position Pin.....
58935	9269	" " " Cover.....
55612	9266	" " " Hinge Pin.....
442C	9285	" " " " Set Screw..
50456C	9266	" " " Lock Screw.....
58936	9266	" " " " Bushing...
171D	9284	" " " " " Screw
58937	9269	" " Ring.....
58947	9266	" " " Position Stud.....
461C	9285	" " " " " Set Screw
1394D	9284	" " Screw.....
21788	9266	" " Spring.....
58938	-----	Shuttle Race complete, Nos. 58934, 58937,
		58951, two 1394D and three 21788....
11241	9271	Tension Friction Washer (felt).....
19684	9271	" " " (steel).....
1535E	9271	" Regulating Thumb Nut.....
8787	9271	" " " " Washer....
50271C	9271	" Screw Stud.....
430C	9271	" " " Set Screw.....
19686	9271	" Spring.....
58795	9271	" Wheel.....
58796	-----	Tension (wheel) complete, Nos. 1535E,
		8787, 19684, 19686, 50271C, 58795 and
		two 11241.....
58797	9271	Tension Wheel Brake with 174E.....
174E	9271	" " " Adjusting Screw.....
58798	9271	" " " Connection.....
1359C	9285	" " " " Hinge
		Screw.....
1597E	9284	Tension Wheel Brake Connection Lock Nut.
1597E	9284	" " " " Nut.....

## PARTS FOR MACHINE No. 97-6

No.	Plate	Name
43945	9271	Tension Wheel Brake Connection Spring...
1660D	9271	" " " " " Thumb Nut.....
996C	9271	Tension Wheel Brake Hinge Screw.....
58799	9271	" " " " " Bushing.
58800	9271	Thread Guide Roller (side of arm).....
58801	9271	" " " " " Cover.....
1042C	9285	" " " " " Screw.....
58939	9273	" " " " " Retainer Plate (lower).....
58940	9273	" " " " " (upper).....
648D	9285	" " " " " Screw.....
58803	9273	" " " " " Spring.....
140147J	-----	" " " " " Screw.....
58956	9275	" " " " " Take-up Cam with 429C.....
8983	9273	" " " " " Pin.....
429C	9285	" " " " " Set Screw.....
58942	9273	" " " " " Support.....
896E	9284	" " " " " Screw.....
58943	9274	" " " " " Lever.....
58944	-----	Thread Take-up Lever complete, Nos. 51806, 58801, 58807, 58943 and two each 1042C and 58800.....
50273C	9284	Thread Take-up Lever Hinge Screw.....
51806	9273	" " " " " Roller and Screw Stud with 1608C.....
1608C	9273	Thread Take-up Lever Roller and Screw Stud Nut.....
58800	9271	Thread Take-up Lever Thread Guide Roller (back).....
58801	9271	Thread Take-up Lever Thread Guide Roller (back) Cover.....
1042C	9285	Thread Take-up Lever Thread Guide Roller (back) Screw.....
58800	9271	Thread Take-up Lever Thread Guide Roller (front).....
58807	9271	Thread Take-up Lever Thread Guide Roller (front) Cover.....
1042C	9285	Thread Take-up Lever Thread Guide Roller (front) Screw.....
58886	9273	Thread Take-up Spring.....
58808	9276	Wax Box.....
1396D	9284	" " " " " Screw.....
58809	9257	" " " " " Tension Bracket.....
181D	9284	" " " " " " " Screw.....
2102	9273	" " " " " Disc.....
1560C	9273	" " " " " Regulating Thumb Nut...
1110C	9273	" " " " " Screw Stud.....
2103	9273	" " " " " Spring.....
58810	9273	" " " " " Thread Guide.....
58893	9272	" " " " " Thread Guide Roller.....

## PARTS FOR MACHINE No. 97-6

No.	Plate	Name
58894	9272	Wax Box Thread Guide Roller Cover.....
50430	9285	" " " " " " " Screw.....
58811	9272	" " " " " " " Stripper (lower).....
58812	9272	" " " " " " " " " Arm.....
50431	9285	" " " " " " " " " Hinge Screw.....
58813	9272	Wax Box Thread Stripper (lower) Arm Spring.....
199D	9284	Wax Box Thread Stripper (lower) Arm Spring Screw.....
836E	9285	Wax Box Thread Stripper (lower) Hinge Screw.....
58814	9272	Wax Box Thread Stripper (lower) Spring..
1423D	9284	" " " " " " " " " Screw.....
58815	9272	Wax Box Thread Stripper (upper).....
181D	9284	" " " " " " " " " Screw...
58816	-----	Wax Box complete, Nos. 199D, 836E, 1110C, 1423D, 1560C, 2103, 50431, 58808 to 58815, two 2102 and three each 181D, 50430, 58893 and 58894.....

SINGER Needles should be used  
in SINGER Machines  
These Needles and their Containers  
are marked with the  
Company's Trade Mark "SIMANCO.\*\*" 1

Needles in Containers marked  
"FOR SINGER MACHINES"  
are NOT SINGER made needles. 2

**MACHINE No. 97-7**

THIS MACHINE IS THE 97-6 MACHINE WITH COLUMN STAND No. 25274, FOR FOOT POWER AND THE FOLLOWING EXCEPTION:

No.	Plate	Name
58845	9281	Balance Wheel (two speed) 6 in. and 8 in. diam. with two 344C, in place of 58709.....

**MACHINE No. 97-8**

THIS MACHINE IS THE 97-6 MACHINE, FOR MECHANICAL POWER. COLUMN STAND No. 25275. COUNTERSHAFT No. 46603. CLEARANCE UNDER PRESSER FOOT 1 1/4 INCHES.

**MACHINE No. 97-9**

THIS MACHINE IS THE 97-6 MACHINE, FOR DIRECT CURRENT ELECTRICAL POWER. COLUMN STAND No. 25276. CLEARANCE UNDER PRESSER FOOT 1 1/4 INCHES.

NOTE: ORDER MUST STATE THE NUMBER OF MOTOR REQUIRED, SO THAT CORRECT VOLTAGE CAN BE FURNISHED.

SEE MOTOR SECTION, SHOWING MOTOR FOR CLASS 97 MOTORS IN FORM 19100.

**MACHINE No. 97-10**

THIS MACHINE IS THE 97-6 MACHINE, FOR ALTERNATING CURRENT ELECTRICAL POWER. COLUMN STAND No. 25276. CLEARANCE UNDER PRESSER FOOT 1 1/4 INCHES.

NOTE: ORDER MUST STATE THE NUMBER OF MOTOR REQUIRED, SO THAT CORRECT VOLTAGE, CYCLES AND PHASE CAN BE FURNISHED.

SEE MOTOR SECTION, SHOWING MOTOR FOR CLASS 97 MOTORS IN FORM 19100

**ACCESSORIES**

No.	Plate	Name
120344	9277	Oiler (copper plated) with 120345.....
120345	9277	" Spout, 5 in. long.....
11831	9277	Screw Driver (large).....
26026	9277	" " (medium).....
26485	9277	" " (small).....
120571	9277	Shuttle Cylinder Opener for 58786.....
58888	9277	Stitch Spacing Gauge.....
120341	9277	Tweezers (curved).....
8908	9277	Wrench for 1520.....
27662	9277	" " 1508 and 1619.....
58843	9277	" and Screw Driver for 1177,1513 and 1608.....
58844	9277	Wrench for 1597 and 1736.....

**IRON BASE**

No.	Plate	Name
58817	9281	Machine Base.....
51077E	9279	" " Bolt with 51581E.....
51581E	9279	" " " Nut.....
6055	9279	" " " Washer.....
731E	3840	" Screw.....

**BOBBIN WINDER**

No.	Plate	Name
58971	9281	Base.....
58980	-----	" 58971 with 58850,58851 and six 1396D
58822	9279	Bobbin Position Pin.....
58846	9279	Gas Burner with 58848.....
58847	-----	" " 58846 with 58849.....
58848	9255	" " Pin.....
58849	9255	" " Regulator.....
58827	9279	" Pipe.....
58823	9275	Gear.....
58850	9283	" Bracket with 858C.....
1396D	9284	" " Screw.....
27797	9279	" Handle (wood).....
58824	9279	" " Stud.....
58825	-----	" " " 58824 with 27797 and 27799.....



## BOBBIN WINDER

No.	Plate	Name
167D	9279	Gear Handle Stud Cap Screw.....
27799	9279	" " " Washer.....
46558	9279	" Hinge Stud.....
858C	9270	" " " Set Screw.....
58828	9279	Pinion with 457C.....
457C	9259	" Set Screw.....
58829	9279	Spindle.....
452C	9279	" Set Screw.....
58830	9278	" Shaft with 452C and 58822.....
58851	9276	Water Box.....
1396D	9284	" " Screw.....
58831	9275	Wax Box.....
58832	9283	" " Tension Bracket.....
58895	-----	" " " " 58832 with 916C, 1042C,1560C,2103,17547,50310E,58800, 58833 and two 2102.....
771D	9279	Wax Box Tension Bracket Thumb Screw....
2102	9273	" " " Disc.....
1560C	9273	" " " Regulating Thumb Nut....
916C	9279	" " " Screw Stud.....
2103	9273	" " " Spring.....
17547	9278	" " " Thread Guide.....
58800	9271	" " " " " Roller....
1042C	9285	" " " " " " Screw
58833	9278	" " " " " Stripper (rubber)
50310E	9278	" " " " " Regulat- ing Screw Stud.....
58834	-----	Bobbin Winder complete, Nos. 167D,46558, 58823, 58825, 58827 to 58831, 58835, 58847, 58895, 58980, two each 771D, wood screws 1 3/4 in. No. 14 and six 1396D.....
58835	9282	Threading Wire.....

### BOBBIN WINDER

(ELECTRICALLY HEATED)

No.	Plate	Name
58971	9281	Base.....
58981	-----	" 58971 with 58850,58972 and six 1396D
58822	9279	Bobbin Position Pin.....
195149	-----	Cord with Plug complete.....
192919	-----	Cord and Plug complete for 220-240 volts, Nos. 190715 and 195149.....
192920	-----	Cord and Plug complete for 105-125 volts, Nos. 190713 and 195149.....

Note: If voltage other than the above is required, it must be stated on order.

## BOBBIN WINDER

No.	Plate	Name
91363	9278	Cord Strap.....
164D	9284	" " " Screw.....
58823	9275	Gear.....
58850	9283	" Bracket with 858C.....
1396D	9284	" " " Screw.....
27797	9279	" Handle (wood).....
58824	9279	" " Stud.....
58825	-----	" " " 58824 with 27797 and 27799.....
167D	9279	Gear Handle Stud Cap Screw.....
27799	9279	" " " Washer.....
46558	9279	" Hinge Stud.....
858C	9270	" " " Set Screw.....
*190712	-----	Heater Cartridge (110 volts).....
190713	9280	" " " 190712 with thirty-four 190719.....
190714	-----	Heater Cartridge (220 volts).....
190715	9280	" " " 190714 with thirty-four 190719.....
Note: If voltage other than the above is required, it must be so stated on order.		
190719	9278	Heater Insulating Beads.....
58828	9279	Pinion with 457C.....
457C	9259	" Set Screw.....
58829	9279	Spindle.....
452C	9279	" Set Screw.....
58830	9278	" Shaft with 452C and 58822.....
58972	9283	Water Box with 58973.....
58973	9282	" " Plug.....
1396D	9284	" " Screw.....
58831	9275	Wax Box.....
58832	9283	" " Tension Bracket.....
58895	-----	" " " " 58832 with 916C, 1042C,1560C,2103,17547,50310E,58800, 58833 and two 2102.....
771D	9279	Wax Box Tension Bracket Thumb Screw....
2102	9273	" " " Disc.....
1560C	9273	" " " Regulating Thumb Nut....
916C	9279	" " " Screw Stud.....
2103	9273	" " " Spring.....
17547	9278	" " " Thread Guide.....
58800	9271	" " " " " Roller....
1042C	9285	" " " " " " Screw
58833	9278	" " " " " Stripper (rubber)
50310E	9278	" " " " " Regulat- ing Screw Stud.....

No.	Plate	Name
58974	-----	Bobbin Winder complete, 110 or 220 volts, Nos. 164D, 167D, 46558, 58823, 58825, 58828 to 58831, 58835, 58895, 58981, 91363, 192919 or 192920, two each 771D, wood screws 1 3/4 in. No. 14 and six 1396D.....
Note: If voltage other than the above is required, it must be so stated on order.		
58835	9282	Threading Wire.....

## ELECTRIC HEATING ATTACHMENT

No.	Plate	Name
195150	-----	Cord with Plug complete.....
192921	-----	Cord and Plug complete for 240 volts, Nos. 195150, two each 1768R, 50577R, 191198 and three 190715.....
192922	-----	Cord and Plug complete for 105-125 volts, Nos. 195150, two each 1768R, 50577R, 191198 and three 190713.....
Note: If voltage other than the above is required, it must be so stated on order.		
191198	-----	Cord Connector Block.....
50577R	-----	" " " Screw.....
1768R	-----	" " " " Nut.....
91363	9278	" Strap.....
164D	9284	" " Screw.....
*190712	-----	Heater Cartridge (110 volts).....
190713	9280	" " 190712 with thirty-four 190719.....
190714	-----	Heater Cartridge (220 volts).....
190715	9280	" " 190714 with thirty-four 190719.....
Note: If voltage other than the above is required, it must be so stated on order.		
190719	9278	Heater Insulating Beads.....
58975	9274	Heating Iron.....
1394D	9284	" " Screw.....
58977	9276	Wax Box with 58973.....
58973	9282	" " Plug.....
1396D	9284	" " Screw.....
58809	9257	" " Tension Bracket.....
181D	9284	" " " " Screw.....
2102	9273	" " " Disc.....
156CC	9273	" " " Regulating Thumb Nut....
111CC	9273	" " " Screw Stud.....
2103	9273	" " " Spring.....
58810	9273	" " " Thread Guide.....
58893	9272	" " " Thread Guide Roller.....
58894	9272	" " " " " Cover.....
50430	9285	" " " " " Screw.....
58811	9272	" " " " " Stripper (lower).....
58812	9272	" " " " " " Arm.....
50431	9285	" " " " " " Hinge Screw.....
58813	9272	Wax Box Thread Stripper (lower) Arm Spring.....
199D	9284	Wax Box Thread Stripper (lower) Arm Spring Screw.....

## ELECTRIC HEATING ATTACHMENT

No.	Plate	Name
836E	9285	Wax Box Thread Stripper (lower) Hinge Screw.....
58814	9272	Wax Box Thread Stripper (lower) Spring..
1423D	9284	" " " " " " " " Screw.....
58815	9272	Wax Box Thread Stripper (upper).....
181D	9284	" " " " " " " " Screw...
58978	-----	Wax Box complete, Nos.199D, 836E, 1110C, 1423D, 1560C, 2103, 50431, 58809 to 58815,58977, two 2102 and three each 181D, 50430, 58893 and 58894.....
58976	-----	Electric Heating Attachment complete,for 110 or 220 volts, Nos. 58978, 192921 or 192922, two each 164D,1394D,58975 and 91363.....

Note: If voltage other than the above is required, it must be so stated on order.

## COLUMN STAND No. 25274

FOR NOS. 97-2 AND 97-7 MACHINES

No.	Plate	Name
46555	3834	Band Wheel, two speed, 15 1/4 in. and 17 1/4 in. diam., with 344C.....
46556	3836	Band Wheel Pitman with four 129E.....
46647	3839	" " " " Ball Stud (lower).....
858C	3841	" " " " " " " " Set Screw.....
46647	3839	Band Wheel Pitman Ball Stud (upper).....
858C	3841	" " " " " " " " Set Screw.....
129E	3841	Band Wheel Pitman Cap (lower) Screw....
129E	3841	" " " " " " (upper) Screw....
344C	3841	" " " " Set Screw.....
46559	3836	" " " " Shaft.....
46561	3836	" " " " Crank with 858C.....
8859	3839	" " " " Pin.....
46650	3839	" " " " Oil Cup.....
46651	3837	" " " " Roller Bearing.....
46652	3838	" " " " " " Cap....
1186D	3841	" " " " " " " " Screw
46562	-----	Base.....
494E	3840	" " Screw.....
12620	3837	" " Washer.....
46669	-----	Belt, size 3/8 in., length 117 in., with 25030.....

No.	Plate	Name
25030	9278	Belt Hook.....
46653	-----	Column.....
16922	3839	" " Dowel Pin.....
46564	3834	" " Extension.....
50309E	3837	" " " " Screw Stud.....
1506E	3841	" " " " " " Nut.....
50347E	3840	" " Screw.....
46563	3835	Foot Lifter Treadle with 858C.....
46584	3835	" " " " Pitman Rod (lower)..
46585	3837	" " " " " " " " Spring.....
2762	3839	Foot Lifter Treadle Pitman Rod (lower) Spring Collar with 362C.....
362C	3841	Foot Lifter Treadle Pitman Rod (lower) Spring Collar Set Screw.....
11466	3839	Foot Lifter Treadle Pitman Rod (lower) Spring Washer.....
46586	3835	Foot Lifter Treadle Pitman Rod (upper)..
2762	3839	" " " " " " " " Stop Collar with 362C.....
362C	3841	Foot Lifter Treadle Pitman Rod (upper) Stop Collar Set Screw.....
80223	-----	Foot Lifter Treadle Pitman Rod Clamp with 361C.....
361C	-----	Foot Lifter Treadle Pitman Rod Clamp Screw.....
46587	-----	Foot Lifter Treadle Pitman complete,Nos. 11466, 46584 to 46586, 80223 and two 2762.....
46557	3839	Foot Lifter Treadle Stud.....
858C	3841	" " " " " " " " Set Screw.....
46697	9286	Table.....
46565	3834	" " 46697 with 46698 and two 731E....
46698	9286	" " Bracket.....
46566	3836	" " Latch.....
9D	3841	" " " " Hinge Screw.....
46567	3837	" " " " Spring.....
731E	3840	" " " " Screw.....
46568	3836	" " Shaft with 453C.....
46569	3838	" " " " Collar with 445C.....
445C	3841	" " " " " " Set Screw.....
344C	3841	" " " " " " Set Screw.....
46570	3834	Tray.....
46571	3834	Treadle (left) with 344C.....
16922	3839	" " " " Pin.....
344C	3841	" " " " " " Set Screw.....
46572	3834	" " (right) with 858C.....
46556	3836	" " " " Pitman with four 129E...
46647	3839	" " " " " " Ball Stud (lower)
858C	3841	" " " " " " " " Set Screw.....

No.	Plate	Name
46647	3839	Treadle (right) Pitman Ball Stud (upper)
858C	3841	" " " " " "
		Set Screw.....
129E	3841	Treadle (right) Pitman Cap (lower) Screw
129E	3841	" " " " (upper) Screw
46573	3834	" Shaft.....
46574	3834	" " Arm with 344C and 858C....
16922	3839	" " Pin.....
344C	3841	" " Set Screw.....
46575	3834	" " Bracket.....
8582	3839	" " Dowel Pin.....
50283E	3840	" " Screw.....
46576	3838	" " Collar with two 445C.....
445C	3841	" " Set Screw.....
25274	-----	Column Stand complete, Nos. 9D, 344C, 46555, 46557, 46559, 46562, 46564 to 46576, 46583, 46587, 46653, two each 8582, 8859, 46556, 46561, 46650, 46651, 50283E, three each 494E, 12620, 50347E, four each 16922, 46647, 46652, 50309E, eight 1506E and twelve 1186D.....

### COLUMN STAND No. 25275

FOR NOS. 97-3 AND 97-8 MACHINES

No.	Plate	Name
46577	3835	Balance Wheel with 344C.....
344C	9285	" " Set Screw.....
46578	3836	" " Shaft.....
46560	3837	" " Bushing.....
795C	3841	" " Set Screw...
524C	3840	" " Cap Screw.....
46650	3839	" " Oil Cup.....
1304C	3841	" " Stop Screw.....
46579	3838	" " Bracket..
1237E	3841	" " " " " "
		Screw.....
1513J	3841	Balance Wheel Shaft Stop Screw Nut.....
46562	-----	Base.....
494E	3840	" Screw.....
46670	-----	Belt, size 3/8 in., length 108 in., with 25030.....
25030	9278	Belt Hook.....
46563	-----	Column.....
16922	3839	" Dowel Pin.....
46564	3834	" Extension.....

No.	Plate	Name
50309E	3837	Column Extension Screw Stud.....
1506E	3841	" " " " Nut.....
50347E	3840	" Screw.....
46580	3835	Driving Arm.....
50313C	3841	" " Adjusting Screw.....
1509C	3841	" " " " Nut.....
46581	3835	" " Bracket.....
50347E	3840	" " Screw.....
865C	3841	" " Screw Center.....
1614E	3841	" " " " Nut.....
46582	3835	" Pulley, 8 in. diam., with two 344C.....
344C	3841	Driving Pulley Set Screw.....
46583	3835	Foot Lifter Treadle with 858C.....
46584	3835	" " Pitman Rod (lower)..
46585	3837	" " " " " "
		Spring.....
2762	3839	Foot Lifter Treadle Pitman Rod (lower) Spring Collar with 362C.....
362C	3841	Foot Lifter Treadle Pitman Rod (lower) Spring Collar Set Screw.....
11466	3839	Foot Lifter Treadle Pitman Rod (lower) Spring Washer.....
46586	3835	Foot Lifter Treadle Pitman Rod (upper)..
2762	3839	" " " " " "
		Stop Collar with 362C.....
362C	3841	Foot Lifter Treadle Pitman Rod (upper) Stop Collar Set Screw.....
80223	-----	Foot Lifter Treadle Pitman Rod Clamp with 361C.....
361C	-----	Foot Lifter Treadle Pitman Rod Clamp Screw.....
46587	-----	Foot Lifter Treadle Pitman complete, Nos. 11466, 46584 to 46586, 80223 and two 2762.....
46557	3839	Foot Lifter Treadle Stud.....
858C	3841	" " " " Set Screw.....
46589	3835	Friction Pulley with 46590.....
46590	3838	" " Bushing.....
46591	3839	" " Center Plug (wood).....
46592	3837	" " Spring.....
8987	3835	" Washer (paper).....
46593	3836	Starting Shaft.....
46594	3835	" " Arm with two 731E, for 46580.....
46595	3835	Starting Shaft Arm with two 731E, for 46597.....
731E	3840	Starting Shaft Arm Clamping Screw.....
46575	3834	" " Bracket.....
8582	3839	" " Dowel Pin.....

No.	Plate	Name
50283E	3840	Starting Shaft Bracket Screw.....
46596	3838	" " Collar with 731E.....
46576	3838	" " " " two 445C.....
731E	3840	" " " Clamping Screw....
445C	3841	" " " Set Screw.....
46597	3835	" Treadle.....
46598	3838	" " Connecting Link with two 858C.....
46557	3839	Starting Treadle Connecting Link Hinge Stud.....
858C	3841	Starting Treadle Connecting Link Hinge Stud Set Screw.....
46599	3837	Starting Treadle Shaft.....
436C	3841	" " " Set Screw.....
46654	3837	" " Spring.....
46600	3835	" " Stand with two 436C....
731E	3840	" " " Screw.....
46697	9286	Table.....
46565	3834	" 46697 with 46698 and two 731E.....
46698	9286	" Bracket.....
46566	3836	" Latch.....
9D	3841	" " Hinge Screw.....
46567	3837	" " Spring.....
731E	3840	" Screw.....
46568	3836	" Shaft with 453C.....
46569	3838	" " Collar with 445C.....
445C	3841	" " " Set Screw.....
344C	3841	" " " Set Screw.....
46570	3834	Tray.....
25275	-----	Column Stand complete, Nos.9D,344C,524C, 1304C, 1509C, 1513J, 8987, 46562 to 46570, 46575 to 46583, 46587, 46589, 46591 to 46600, 46654, 50313C, two each 795C, 865C, 1237E, 1614E, 8582, 16922, 46560, 46650, 50283E, three each 494E, 731E, 46557, four each 50309E, 50347E and eight 1506E.....
46601	3835	Countershaft Hanger.....
50215E	3840	" " Screw.....
46582	3835	" Pulley, 8 in.diam.,with two 344C.....
344C	3841	Countershaft Pulley Set Screw.....
46602	3836	" " Shaft.....
46576	3838	" " " Collar with two 445C.....
445C	3841	Countershaft Pulley Shaft Collar Set Screw.....
46603	-----	Countershaft complete, Nos. 46576,46601, 46602, two 46582 and three 50215E...

Note: 4 ft.10 1/2 in. of 2 in. flat, belting is sent to connect countershaft with stand.

## COLUMN STAND No. 25276

FOR NOS. 97-4, 97-5, 97-9 AND 97-10 MACHINES

No.	Plate	Name
46577	3835	Balance Wheel with 344C.....
344C	9285	" " Set Screw.....
46578	3836	" " Shaft.....
46560	3837	" " " Bushing.....
795C	3841	" " " " Set Screw...
524C	3840	" " " Cap Screw.....
46576	3838	" " " Collar with two 445C
445C	3841	" " " " Set Screw....
46650	3839	" " " Oil Cup.....
1304C	3841	" " " Stop Screw.....
46579	3838	" " " " " Bracket..
1237E	3841	" " " " " " "
		Screw.....
1513J	3841	Balance Wheel Shaft Stop Screw Nut.....
46562	-----	Base.....
494E	3840	" Screw.....
46670	-----	Belt, size 3/8 in., length 108 in., with 25030.....
25030	9278	Belt Hook.....
46606	3836	" Tightener Pulley.....
46607	3836	" " " Arm.....
1405E	3840	" " " " Hinge Screw...
1405E	3840	" " " Hinge Screw.....
46608	3837	" " " Spring.....
46563	-----	Column.....
16922	3839	" Dowel Pin.....
46564	3834	" Extension.....
50309E	3837	" " Screw Stud.....
1506E	3841	" " " " Nut.....
50347E	3840	" Screw.....
46580	3835	Driving Arm.....
50313C	3841	" " Adjusting Screw.....
1509C	3841	" " " " Nut.....
46581	3835	" " Bracket.....
50347E	3840	" " " Screw.....
865C	3841	" " Screw Center.....
1614E	3841	" " " " Nut.....
46583	3835	Foot Lifter Treadle with 858C.....
46584	3835	" " " Pitman Rod (lower)..
46585	3837	" " " " " "
		Spring.....
2762	3839	Foot Lifter Treadle Pitman Rod (lower) Spring Collar with 362C.....

No.	Plate	Name
362C	3841	Foot Lifter Treadle Pitman Rod (lower) Spring Collar Set Screw.....
11466	3839	Foot Lifter Treadle Pitman Rod (lower) Spring Washer.....
46586	3835	Foot Lifter Treadle Pitman Rod (upper)..
2762	3839	" " " " " Stop Collar with 362C.....
362C	3841	Foot Lifter Treadle Pitman Rod (upper) Stop Collar Set Screw.....
80223	-----	Foot Lifter Treadle Pitman Rod Clamp with 361C.....
361C	-----	Foot Lifter Treadle Pitman Rod Clamp Screw.....
46587	-----	Foot Lifter Treadle Pitman complete, Nos. 11466, 46584 to 46586, 80223 and two 2762.....
46557	3839	Foot Lifter Treadle Stud.....
858C	3841	" " " " Set Screw.....
46589	3835	Friction Pulley with 46590.....
46590	3838	" " Bushing.....
46591	3839	" " Center Plug (wood).....
46592	3837	" " Spring.....
8987	3835	" Washer (paper).....
46609	3835	Motor Base.....
46610	-----	Motor Base complete, Nos. 46606 to 46609, two 1405E, three 50215E and four 1062E.....
50215E	3840	Motor Base Screw.....
1062E	3840	" Screw.....
79624	3834	" Starting Box Board.....
51070E	3840	" " " " Bolt with 51581E
51581E	3841	" " " " " Nut.....
11466	3839	" " " " " Washer.....
46593	3836	Starting Shaft.....
46594	3835	" " Arm with two 731E, for 46580
46595	3835	" " " with two 731E, for 46597
731E	3840	" " Clamping Screw.....
46575	3834	" " Bracket.....
8582	3839	" " Dowel Pin.....
50283E	3840	" " Screw.....
46596	3838	" " Collar with 731E.....
46576	3838	" " " with two 445C.....
731E	3840	" " Clamping Screw.....
445C	3841	" " Set Screw.....
46597	3835	" Treadle.....
46598	3838	" " Connecting Link with two 858C.....
46557	3839	Starting Treadle Connecting Link Hinge Stud.....
858C	3841	Starting Treadle Connecting Link Hinge Stud Set Screw.....

No.	Plate	Name
46599	3837	Starting Treadle Shaft.....
436C	3841	" " " Set Screw.....
46654	3837	" " Spring.....
46600	3835	" " Stand with two 436C....
731E	3840	" " " Screw.....
46697	9286	Table.....
46565	3834	" 46697 with 46698 and two 731E....
46698	9286	" Bracket.....
46566	3836	" Latch.....
9D	3841	" " Hinge Screw.....
46567	3837	" " Spring.....
731E	3840	" Screw.....
46568	3836	" Shaft with 453C.....
46569	3838	" " Collar with 445C.....
445C	3841	" " " Set Screw.....
344C	3841	" " " Set Screw.....
46611	3834	Tray.....
25276	-----	Column Stand complete, Nos. 9D, 344C, 524C, 1304C, 1509C, 1513J, 8987, 46562 to 46569, 46575, 46577 to 46581, 46583, 46587, 46589, 46591 to 46600, 46610, 46611, 46654, 50313C, 79624, two each 795C, 865C, 1237E, 1614E, 8582, 16922, 46560, 46576, 46650, 50283E, three each 494E, 731E, 11466, 46557, 51070E, four each 50309E, 50347E and eight 1506E.

Note: 6 ft. 6 in. of 1 1/4 in. flat belting is sent  
to connect motor with stand.

## FOOT LIFTER PARTS

FOR NOS. 97-1 AND 97-6 MACHINES

No.	Plate	Name
58818	9283	Lifting Lever.....
12D	9278	" " Hinge Screw.....
58819	9278	" " Link.....
64D	9278	" " " Hinge Screw.....
46583	3835	Treadle with 858C.....
58839	9274	" Hinge Pin.....
436C	3841	" " " Set Screw.....
46584	3835	" Pitman Rod (lower).....
46585	3837	" " " Spring.....
2762	3839	" " " " " Collar with 362C.....
362C	3841	Treadle Pitman Rod (lower) Spring Collar Set Screw.....

## FOOT LIFTER PARTS

No.	Plate	Name
11466	3839	Treadle Pitman Rod (lower) Spring Washer
46586	3835	" " " (upper).....
2762	3839	" " " " Stop Collar with 362C.....
362C	3841	Treadle Pitman Rod (upper) Stop Collar Set Screw.....
80223	-----	Treadle Pitman Rod Clamp with 361C.....
361C	-----	" " " " Screw.....
46587	-----	Treadle Pitman complete, Nos. 11466, 46584 to 46586, 80223 and two 2762..
58840	9283	Treadle Stand with 436C.....
46557	3839	" Stud.....
856C	3841	" " Set Screw.....
58841	-----	Treadle complete, Nos. 46583, 58839, 58840 and two wood screws 1 1/4 in. No. 16
58842	-----	Foot Lifter complete, Nos. 12D, 64D, 46557, 46587, 58818, 58819 and 58841.....

## FOOT LIFTER PARTS

FOR 25274 TO 25276

No.	Plate	Name
58818	9283	Lifting Lever.....
12D	9278	" " Hinge Screw.....
58819	9278	" " Link.....
64D	9278	" " Hinge Screw.....
46583	3835	Treadle with 856C.....
46584	3835	" Pitman Rod (lower).....
46585	3835	" " " " Spring.....
2762	3839	" " " " Collar with 362C.....
362C	3841	Treadle Pitman Rod (lower) Spring Collar Set Screw.....
11466	3839	Treadle Pitman Rod (lower) Spring Washer
46586	3835	" " " (upper).....
2762	3839	" " " " Stop Collar with 362C.....
362C	3841	Treadle Pitman Rod (upper) Stop Collar Set Screw.....
80223	-----	Treadle Pitman Rod Clamp with 361C.....
361C	-----	" " " " Screw.....
46587	-----	Treadle Pitman complete, Nos. 11466, 46584 to 46586, 80223 and two 2762.....
46557	3839	Treadle Stud.....
856C	8341	" " Set Screw.....

## THREAD UNWINDER

FOR ONE LARGE SPOOL OR ONE LARGE CONE OF THREAD

FOR NOS. 97-1 AND 97-6 MACHINES

No.	Plate	Name
60201	9283	Rod.....
138E	9278	" Set Screw.....
27555	9283	Spool Pin.....
60202	9283	" Rest with 138E.....
138E	9278	" " Set Screw.....
27557	9283	Stand with 138E.....
60203	9283	Thread Guide (cone).....
60204	9283	" " Arm with two 447C.....
447C	9278	" " Set Screw.....
447C	9278	" " Set Screw.....
58800	9271	" Roller.....
60205	9283	" " Guide with 452C.....
11226	9283	" " Pin.....
60206	9278	" " " " Collar with 620C
620C	9278	" " " " Set Screw
452C	9279	" " Set Screw.....
60207	9283	" Straightener with 452C.....
452C	9279	" " Set Screw.....
60208	9283	Thread Unwinder complete, Nos. 11226, 27555, 58800 and 60201 to 60207.....
60931	-----	Thread Unwinder 60208 with 27557 and three wood screws 1 1/4 in. No. 12..

## THREAD UNWINDER

FOR ONE LARGE SPOOL OR ONE LARGE CONE OF THREAD

FOR NOS. 97-2 TO 97-5 AND 97-7 TO 97-10 MACHINES

No.	Plate	Name
60201	9283	Rod.....
453C	9254	" Set Screw for 46568.....
27555	9283	Spool Pin.....
60202	9283	" Rest with 138E.....
138E	9278	" " Set Screw.....
60203	9283	Thread Guide (cone).....
60204	9283	" " Arm with two 447C.....
447C	9278	" " Set Screw.....

## THREAD UNWINDER

No.	Plate	Name
447C	9278	Thread Guide Set Screw.....
58800	9271	" Roller.....
60205	9283	" " Guide with 452C.....
11226	9283	" " " Pin.....
60206	9278	" " " Collar with 62CC
620C	9278	" " " " Set Screw
452C	9279	" " " Set Screw.....
60207	9283	" Straightener with 452C.....
452C	9279	" " Set Screw.....
60208	9283	Thread Unwinder complete, Nos. 11226, 27555, 58800 and 60201 to 60207.....

## UNDER DRIVER

(BELT TIGHTENER)

LEVER PRESSURE (RIGHT HAND) ONE SPEED, (FLAT PULLEY)  
FOR NOS. 97-1 AND 97-6 MACHINES

No.	Plate	Name
126583	7877	Base with two 50288C.....
126572	7980	Belt Guard.....
50058D	7978	" " Screw.....
126584	7980	" Tightener Screw.....
55767	7978	" " " Hinge Stud.....
50288C	7978	" " " " Set Screw
1796E	7978	" " " Nut.....
126585	7979	" " " Washer.....
126573	7978	Brake (thermoid).....
126791	-----	" Lever with 50058R, 51067C and two 60823.....
423C	-----	Brake Lever Adjusting Screw.....
60823	-----	" " " " 423C with 1520R.....
1520R	-----	Brake Lever Adjusting Screw Nut.....
127000	-----	" " Separating Washer.....
51067C	7978	" " Set Screw.....
126575	7980	" " Spring.....
126169	7877	Driving Pulley (right hand) 6 3/4 in. diam., with 60911, 60935, 126202 and two 126895.....
60911	7877	Driving Pulley Friction Ring (leather)..
60935	7978	" " " Stop Pin...
*126756	7877	" " Shaft (hollow) right hand
*126576	-----	" " " 126756 with 204107, 204108 and eleven 25303.....

## UNDER DRIVER

No.	Plate	Name
126577	-----	Driving Pulley Shaft complete, Nos. 126173, 126175, 126576, 126578 and 126757.....
25303	7978	Driving Pulley Shaft Ball, size 1/4 in..
204107	7979	" " " " Cup.....
204108	7979	" " " " Cap.....
126173	7978	" " " Oiling Leather....
126757	9278	" " " " Clip
126175	7978	" " " " Plug
126578	7980	" " " Wick.....
50959C	7978	" " " Set Screw.....
204113	7978	" " " Thimble.....
126895	-----	" " Spring.....
126201	7979	" " " Retaining Washer..
126202	-----	Driving Pulley Spring Retaining Washer complete, Nos. 126201 and 126203....
126203	7978	Driving Pulley Spring Retaining Washer Pin.....
126586	7877	Frame with 50959C.....
40063	7980	" Hinge Pin.....
50288C	7978	" " " Set Screw.....
126179	7877	Friction Pulley (right hand) with 227553 and four 50512E.....
25362	7978	Friction Pulley Ball, size 3/16 in.....
204100	7979	" " " Bearing Cup.....
204101	7979	" " " Cap.....
204102	7979	" " " Retaining Spring..
227553	-----	Friction Pulley Ball Cup complete, Nos. 204100 to 204102 and thirteen 25362.
126792	-----	Lever (compression) and Dress Guard with 200524C, 204117 and two 202845.....
200524C	7978	Lever (compression) and Dress Guard Set Screw.....
204117	7979	Lever (compression) Plate.....
202845	7978	" " " Rivet.....
126580	9282	" Shaft.....
123183	7978	" " Cotter Pin.....
126587	-----	Pulley (flat) 3 in. diam.....
126588	7877	" " 4 in. diam.....
126589	-----	" " 5 in. diam.....
Note: No. 126588 is sent with this transmitter un- less another pulley is specified on order.		
50512E	7978	Pulley Screw.....
11864	9281	Shaft Driving Pulley (sectional) 10 in. diam., 1 1/4 in. face, 1 3/16 in. bore, with two 597C.....
597C	9278	Shaft Driving Pulley Clamping Screw....
126036	9281	Treadle.....
126037	-----	" 126036 with 2718R, 50581R and 126038.....



No.	Plate	Name
126205	9282	Treadle Bracket (left).....
126206	-----	Treadle Bracket (left) complete, Nos. 23258, 126205, 126207, 126208 and two wood screws 1 in. No. 14.....
126207	9278	Treadle Bracket (left) Hook.....
23258	9278	" " " " Friction Washer.....
126208	9278	Treadle Bracket (left) Hook Rivet.....
46681	9282	" " (right).....
60502	-----	" " " 46681 with two wood screws 1 in. No. 14.....
126038	9275	Treadle Extension.....
50581R	9278	" " Screw.....
2718R	9278	" " " Washer.....
60858	9282	" Hanging Hook.....
27639	9275	" Pitman Rod.....
80223	-----	" " " Clamp with 361C.....
361C	-----	" " " " Screw.....
60626	9275	Treadle Pitman complete, two each Nos. 27639 and 80223.....
126211	-----	Treadle complete, Nos. 60502, 126037 and 126206.....
126212	-----	Treadle and Pitman complete, Nos. 60626, 60858 and 126211.....
126590	-----	Transmitter (belt tightener) complete, Nos. 40063, 55767, 123183, 126169, 126179, 126572, 126573, 126575, 126577, 126580, 126583, 126584, 126586, 126588, 126791, 126792, 127000, 204113, two each 1796E, 126585 and three wood screws 1 3/4 in. No. 16.....
126591	-----	Under Driver (belt tightener) lever pressure (right hand) one speed (flat pulley) complete, Nos. 11864, 126212 and 126590.....

## OBSOLETE PARTS

No.	Plate	Name
58705	9251	Arm Shaft.....
286D	9284	" Side Cover Thumb Screw, obsolete, use 51224J.....
67090	9280	Bobbin Winder Cord with 192540, for 192919 and 192920, obsolete.....
192540	9280	Bobbin Winder Cord Plug complete for 67090, Nos. 192541 to 192543, obso- lete.....
192541	-----	Bobbin Winder Cord Plug Base for 192540, obsolete.....
192542	-----	Bobbin Winder Cord Plug Cap for 192540, obsolete.....
192543	9279	Bobbin Winder Cord Plug Flash Disc (fibre) for 192540, obsolete.....
67090	9280	Cord with 192540, for 192921 and 192922, obsolete.....
192540	9280	Cord Plug complete for 67090, Nos. 192541 to 192543, obsolete.....
192541	-----	Cord Plug Base for 192540, obsolete.....
192542	-----	" " Cap for 192540, obsolete.....
192543	9279	" " Flash Disc (fibre) for 192540, obsolete.....
9079	3839	Foot Lifter Treadle Pitman Rod Clamp with 354C, for 46587, obsolete, use 80223.....
354C	3841	Foot Lifter Treadle Pitman Rod Clamp Screw for 9079, obsolete, use 361C..
386C	9285	Needle Bar Connecting Link Crank (out- side) Clamping Screw.....
58730	9255	Needle Bar Connecting Link Crank (out- side) Gib.....
58837	9270	Needle Bar Plug.....
58838	9270	" " " Rivet.....
58748	9257	" Guide (upper) Bar Bracket with two 1177C, for 97-1 to 97-5 Machines....
58917	9257	Needle Guide (upper) Bar Bracket with two 1177C, for 97-6 to 97-10 Ma- chines.....
58750	9272	Needle Guide (upper) Bar Bracket Slide Block for 97-1 to 97-5 Machines, ob- solete, use 58919.....
58919	9272	Needle Guide (upper) Bar Bracket Slide Block for 97-6 to 97-10 Machines....
58837	9270	Needle Guide (upper) Bar Plug.....
58838	9270	" " " " " Rivet.....
58765	9272	Presser Bar Clutch for 97-1 to 97-5 Ma- chines, obsolete, use 58927.....

## OBSOLETE PARTS

No.	Plate	Name
58771	9272	Presser Bar Clutch Spring.....
1309C	9284	" " " " Bracket Screw, obsolete, use 134E.....
58776	9263	Presser Bar Spring Bracket with two 1186C, obsolete, use 58836.....
1186C	3841	Presser Bar Spring Bracket Clamping Screw for 58776.....
1396D	9284	Presser Foot Holder Clamping Screw for 58781.....
164D	9284	Presser Foot Screw, obsolete, use 162D..
58783	9266	Shuttle Cylinder Latch for 58891.....
58979	9266	" " " " obsolete, use 58826
8961	9266	" " " " Hinge Pin, obsolete, use 58527.....
58790	9266	Shuttle Race Cover Hinge Pin for 58794..
690J	9284	Thread Retainer Spring Screw, obsolete, use 140147J.....
58804	9275	Thread Take-up Cam with 50272C.....
58941	9275	" " " " with 50272C, for 58705
50272C	9284	" " " " Position Screw for 58804 and 58941.....
9079	3839	Treadle Pitman Rod Clamp with 354C, ob- solete, use 80223.....
354C	3841	Treadle Pitman Rod Clamp Screw, obso- lete, use 361C.....
9079	3839	Under Driver Treadle Pitman Rod Clamp with 354C, for 60626, obsolete, use 80223.....
354C	3841	Under Driver Treadle Pitman Rod Clamp Screw for 9079, obsolete, use 361C..
828C	9273	Wax Box Tension Screw Stud for 58816, ob- solete, use 1110C.....
58800	9271	Wax Box Thread Guide Roller for 58816...
58801	9271	" " " " " Cover for 58816
1042C	9285	" " " " " Screw for 58816
35E	9265	" " " " Stripper (lower) Arm Hinge Screw for 58816.....

## NUMERICAL LIST OF PARTS

No.	Plate	Name
9D	3841	Table Latch Hinge Screw for 25274 to 25276.....
12D	9278	Lifting Lever Hinge Screw for 25274 to 25276 and 58842.....
14C	9272	Needle Bar Frame Connection Arm Hinge Screw.....
26D	9285	Shuttle Race Screw for 58794.....
35E	9265	Wax Box Thread Stripper (lower) Arm Hinge Screw for 58816, obsolete....
64D	9278	Lifting Lever Link Hinge Screw for 25274 to 25276 and 58842.....
90D	9265	Thread Retainer Plate Screw for 97-1 to 97-5 Machines.....
114D	9284	Needle Plate Clamping Screw for 58754 and 58925.....
129E	3841	Band Wheel Pitman Cap (lower) Screw for 46556.....
129E	3841	Band Wheel Pitman Cap (upper) Screw for 46556.....
129E	9284	Crank Connecting Rod Cap Screw for 58710
129E	3841	Treadle (right) Pitman Cap (lower) Screw for 46556.....
129E	3841	Treadle (right) Pitman Cap (upper) Screw for 46556.....
134E	-----	Presser Bar Clutch Spring Bracket Screw.
138E	9278	Thread Unwinder Rod Set Screw for 27557.
138E	9278	" " " " Spool Rest Set Screw for 60202.....
162D	-----	Presser Foot Screw.....
164D	9284	Bobbin Winder Cord Strap Screw for 58974
164D	9284	Cord Strap Screw for 58976.....
164D	9284	Presser Foot Screw, obsolete, use 162D..
167D	9279	Bobbin Winder Gear Handle Stud Cap Screw for 58834 and 58974.....
171D	9284	Shuttle Race Cover Lock Screw Bushing Screw for 58951.....
174E	9271	Tension Wheel Brake Adjusting Screw for 58797.....
181D	9284	Needle Guide (upper) Bar Bracket Slide Block Cushion Screw.....
181D	9284	Wax Box Tension Bracket Screw for 58816 and 58978.....
181D	9284	Wax Box Thread Stripper (upper) Screw for 58816 and 58978.....
190E	9284	Oscillating Shaft Crank Slide Block Cap Screw for 5868.....

## NUMERICAL LIST OF PARTS

No.	Plate	Name
199D	9284	Wax Box Thread Stripper (lower) Arm Spring Screw for 58816 and 58978....
210D	9284	Flame Protector Screw for 58865 and 58953.....
210D	9284	Heating Plate Screw for 58865 and 58953.
286D	9284	Arm Side Cover Thumb Screw, obsolete, use 51224J.....
313C	9285	Needle Plate Holder Set Screw.....
344C	9285	Balance Wheel Set Screw for 46577, 58709 and 58845.....
344C	3841	Band Wheel Set Screw for 46555.....
344C	3841	Countershaft Pulley Set Screw for 46582.
344C	3841	Driving Pulley Set Screw for 46582.....
344C	3841	Table Shaft Set Screw for 25274 to 25276
344C	3841	Treadle (left) Set Screw for 46571.....
344C	3841	" Shaft Arm Set Screw for 46574...
354C	3841	Foot Lifter Treadle Pitman Rod Clamp Screw for 9079, obsolete, use 361C..
354C	3841	Treadle Pitman Rod Clamp Screw for 9079, obsolete, use 361C.....
354C	3841	Under Driver Treadle Pitman Rod Clamp Screw for 9079, obsolete, use 361C..
361C	-----	Foot Lifter Treadle Pitman Rod Clamp Screw for 80223.....
361C	-----	Treadle Pitman Rod Clamp Screw for 80223
361C	-----	Under Driver Treadle Pitman Rod Clamp Screw for 80223.....
362C	3841	Foot Lifter Treadle Pitman Rod (lower) Spring Collar Set Screw for 2762....
362C	3841	Foot Lifter Treadle Pitman Rod (upper) Stop Collar Set Screw for 2762.....
362C	3841	Treadle Pitman Rod (lower) Spring Collar Set Screw for 2762.....
362C	3841	Treadle Pitman Rod (upper) Stop Collar Set Screw for 2762.....
378C	9285	Needle Bar Frame Connection Slide Block Hinge Screw.....
386C	9285	Needle Bar Connecting Link Crank (outside) Clamping Screw for 58729, obsolete.....
423C	-----	Under Driver Brake Lever Adjusting Screw for 60823.....
428C	9259	Presser Bar Clutch Lifting Stud Roller Screw for 58770.....
429C	9285	Thread Take-up Cam Set Screw for 58955 and 58956.....
430C	9271	Tension Screw Stud Set Screw.....
436C	3841	Starting Treadle Shaft Set Screw for 46600.....
436C	3841	Treadle Hinge Pin Set Screw for 58840...

## NUMERICAL LIST OF PARTS

No.	Plate	Name
442C	9285	Shuttle Race Cover Hinge Pin Set Screw for 58951.....
445C	3841	Balance Wheel Shaft Collar Set Screw for 46576.....
445C	3841	Countershaft Pulley Shaft Collar Set Screw for 46576.....
445C	3841	Starting Shaft Collar Set Screw for 46576.....
445C	3841	Table Shaft Collar Set Screw for 46569..
445C	3841	Treadle Shaft Collar Set Screw for 46576
447C	9278	Thread Unwinder Thread Guide Arm Set Screw for 60204.....
447C	9278	Thread Unwinder Thread Guide Set Screw for 60204.....
452C	9279	Bobbin Winder Spindle Set Screw for 58830.....
452C	9279	Thread Unwinder Thread Roller Guide Set Screw for 60205.....
452C	9279	Thread Unwinder Thread Straightener Set Screw for 60207.....
453C	9254	Oscillating Shaft Collar Set Screw for 11393.....
453C	9254	Shuttle Driver Set Screw for 58787.....
453C	9254	Thread Unwinder Rod Set Screw for 46568.
457C	9259	Bobbin Winder Pinion Set Screw for 58828
457C	9259	Presser Bar Clutch Lever Hinge Pin Set Screw for 58927.....
461C	9285	Shuttle Race Ring Position Stud Set Screw for 58933.....
494E	3840	Base Screw for 25274 to 25276.....
524C	3840	Balance Wheel Shaft Cap Screw for 25275 and 25276.....
597C	9278	Under Driver Shaft Driving Pulley Clamping Screw for 11864.....
604C	9285	Crank Connecting Rod Hinge Screw.....
604C	9285	Feed Regulator Connection Hinge Screw...
604C	9285	Needle Bar Frame Hinge Screw.....
609D	9285	Pressure Regulating Thumb Screw.....
620C	9278	Thread Unwinder Thread Roller Guide Pin Collar Set Screw for 60206.....
622C	9285	Oscillating Rock Shaft Hinge Pin Screw Bushing.....
648D	9285	Thread Retainer Plate Screw for 97-6 to 97-10 Machines.....
671D	9262	Guide Thumb Screw.....
690D	9284	Arm Front Cover Spring Screw.....
690J	9284	Thread Retainer Spring Screw, obsolete, use 140147J.....
731E	3840	Machine Screw for 97-1 to 97-6 Machines.
731E	3840	Table Screw for 46565.....

## NUMERICAL LIST OF PARTS

No.	Plate	Name
731E	3840	Starting Shaft Arm Clamping Screw for 46594 and 46595.....
731E	3840	Starting Shaft Collar Clamping Screw for 46596.....
731E	3840	Starting Treadle Stand Screw for 25275 and 25276.....
771D	9279	Bobbin Winder Wax Box Tension Bracket Thumb Screw for 58834 and 58974.....
773F	9285	Shuttle Tension Regulating Screw for 58890.....
795C	3841	Balance Wheel Shaft Bushing Set Screw for 25275 and 25276.....
828C	9273	Wax Box Tension Screw Stud for 58816, obsolete, use 1110C.....
836E	9285	Wax Box Thread Stripper (lower) Hinge Screw for 58816 and 58978.....
858C	3841	Arm Shaft Bushing (intermediate) Set Screw.....
858C	3841	Arm Shaft Flanged Bushing (front) Set Screw.....
858C	3841	Band Wheel Pitman Ball Stud (lower) Set Screw for 46574.....
858C	3841	Band Wheel Pitman Ball Stud (upper) Set Screw for 46561.....
858C	9270	Bobbin Winder Gear Hinge Stud Set Screw for 58850.....
858C	3841	Feed Cam Set Screw for 58713.....
858C	3841	" Regulator Shaft Collar Set Screw for 58719.....
858C	9270	Feed Shaft Collar (back) Set Screw for 58721.....
858C	9270	Feed Shaft Collar (front) Set Screw for 58722.....
858C	9270	Feed Shaft Crank (front) Set Screw for 58724.....
858C	3841	Foot Lifter Treadle Stud Set Screw for 46583.....
858C	9270	Presser Bar Spring Bracket Set Screw for 58836.....
858C	3841	Starting Treadle Connecting Link Hinge Stud Set Screw for 46598.....
858C	3841	Treadle (right) Pitman Ball Stud (lower) Set Screw for 46572.....
858C	3841	Treadle (right) Pitman Ball Stud (upper) Set Screw for 46561.....
858C	3841	Treadle Stud Set Screw for 46583.....
865C	3841	Driving Arm Screw Center for 25275 and 25276.....
866D	9285	Arm Front Cover Screw.....
866C	9285	Presser Bar Clutch Lifting Lever Hinge Screw.....

## NUMERICAL LIST OF PARTS

No.	Plate	Name
896E	9284	Thread Take-up Cam Support Screw.....
908C	9285	Needle Guide (lower) Rock Shaft Crank Connecting Rod Hinge Screw (lower)..
916C	9279	Bobbin Winder Wax Box Tension Screw Stud for 58895.....
961C	9285	Needle Guide (lower) Rock Shaft Crank Connecting Rod Hinge Screw (upper)..
964F	9284	Needle Bar Connecting Stud Cap Screw....
996C	9271	Tension Wheel Brake Hinge Screw.....
1019C	-----	Shuttle Race Set Screw for 58788.....
1029F	9284	Presser Bar Clutch Spring Screw.....
1042C	9285	Bobbin Winder Wax Box Tension Thread Guide Roller Screw for 58895.....
1042C	9285	Thread Guide Roller Screw.....
1042C	9285	" Take-up Lever Thread Guide Roller (back) Screw for 58806 and 58944....
1042C	9285	Thread Take-up Lever Thread Guide Roller (front) Screw for 58806 and 58944....
1042C	9285	Wax Box Thread Guide Roller Screw for 58816, obsolete.....
1054C	9285	Oscillating Shaft Crank Slide Block Screw Stud for 5868.....
1062E	3840	Motor Screw for 46610.....
1065C	9284	Feed Regulator Position Screw for 58714 and 58958.....
1110C	9273	Wax Box Tension Screw Stud for 58816 and 58978.....
1177D	9284	Face Plate Screw (lower) right.....
1177D	9284	" " " (upper).....
1177D	9284	Needle Guide (lower) Screw.....
1177C	9284	" " (upper) Bar Bracket Clamping Screw for 58748, 58917, 58959 and 58960.....
1177D	9284	Oscillating Shaft Crank Clamping Screw for 58762.....
1177D	9284	Presser Foot Holder Clamping Screw for 58781 and 58932.....
1186D	3841	Band Wheel Shaft Roller Bearing Cap Screw for 25274.....
1186D	9284	Face Plate Screw (lower) left, for 97-1 to 97-5 Machines.....
1186D	9284	Gas Burner Pipe Bracket Screw for 58865 and 58953.....
1186C	9284	Needle Bar Connecting Link Crank (inside) Clamping Screw for 58728.....
1186D	9284	Needle Bar Connecting Stud Clamping Screw for 58733 and 58901.....
1186F	9284	Needle Clamp Screw for 58900.....
1186C	9284	Needle Guide (upper) Clamping Screw for 58746, 58874 to 58878, 58910 to 58915, 58966, 58968 and 58970.....

## NUMERICAL LIST OF PARTS

No.	Plate	Name
1186C	3841	Presser Bar Spring Bracket Clamping Screw for 58776, obsolete.....
1237E	3841	Balance Wheel Shaft Stop Screw Bracket Screw for 25275 and 25276.....
1304C	3841	Balance Wheel Shaft Stop Screw for 25275 and 25276.....
1309C	9284	Presser Bar Clutch Spring Bracket Screw, obsolete, use 134E.....
1342F	9285	Presser Bar Clutch Spring Screw Stud....
1354C	9285	" " " Clamp Adjusting Screw for 58990.....
1359C	9285	Tension Wheel Brake Connection Hinge Screw.....
1394D	9284	Face Plate Screw (lower) left, for 97-6 to 97-10 Machines.....
1394D	9284	Heating Iron Screw for 58976.....
1394D	9284	Shuttle Race Screw for 58938.....
1396D	9284	Arm Shaft Flanged Bushing (back) Screw..
1396D	9284	Bobbin Winder Gear Bracket Screw for 58980 and 58981.....
1396D	9284	Bobbin Winder Water Box Screw for 58834 and 58974.....
1396D	9284	Feed Regulator Connection Hinge Screw Clamping Screw.....
1396D	9284	Feed Shaft Crank (back) Clamping Screw for 58723.....
1396D	9284	Feed Shaft Crank (front) Clamping Screw for 58724.....
1396C	9284	Needle Bar Frame Hinge Screw Clamping Screw.....
1396D	9284	Needle Guide (lower) Rock Shaft Crank Clamping Screw for 58743.....
1396D	9284	Needle Guide (lower) Rock Shaft Crank Connecting Rod Hinge Screw (lower) Clamping Screw.....
1396D	9284	Needle Guide (lower) Rock Shaft Crank Connecting Rod Hinge Screw (upper) Clamping Screw.....
1396D	9284	Oscillating Shaft Crank Slide Block Screw Stud Clamping Screw for 58762.....
1396D	9284	Presser Bar Guide Bracket Clamping Screw for 58772.....
1396D	9284	Presser Bar Guide Bracket Guide Stud Clamping Screw for 58772.....
1396D	9284	Presser Bar Spring Bracket Clamping Screw for 58836.....
1396D	9284	Presser Foot Holder Clamping Screw for 58781, obsolete.....
1396D	9284	Wax Box Screw.....
1405E	3840	Belt Tightener Pulley Arm Hinge Screw for 46610.....

## NUMERICAL LIST OF PARTS

No.	Plate	Name
1405E	3840	Belt Tightener Pulley Hinge Screw for 46610.....
1423D	9284	Wax Box Thread Stripper (lower) Spring Screw for 58816 and 58978.....
1467H	9284	Presser Bar Clutch Clamp Cap Screw for 58990.....
1506E	3841	Column Extension Screw Stud Nut for 25274 to 25276.....
1508E	9284	Oscillating Rock Shaft Hinge Pin Nut....
1508E	9284	" " " " " Screw Bushing Nut.....
1509C	3841	Driving Arm Adjusting Screw Nut for 25275 and 25276.....
1513J	3841	Balance Wheel Shaft Stop Screw Nut for 25275 and 25276.....
1513J	9284	Crank Connecting Rod Hinge Screw Nut....
1513J	9284	Feed Regulator Adjusting Stud Nut.....
1520E	9284	Needle Bar Frame Connection Slide Block Hinge Screw Nut.....
1520E	9284	Presser Bar Clutch Clamp Adjusting Screw Nut for 58990.....
1520R	-----	Under Driver Brake Lever Adjusting Screw Nut for 60823.....
1535E	9271	Tension Regulating Thumb Nut for 58796..
1560C	9273	Bobbin Winder Wax Box Tension Regulating Thumb Nut for 58895.....
1560C	9273	Wax Box Tension Regulating Thumb Nut for 58816 and 58978.....
1597E	9284	Tension Wheel Brake Connection Lock Nut.
1597E	9284	" " " " " Nut.....
1608C	9273	Thread Take-up Lever Roller and Screw Stud Nut for 51806.....
1614E	3841	Driving Arm Screw Center Nut for 25275 and 25276.....
1619E	9284	Needle Bar Frame Connection Hinge Screw Nut.....
1654C	9284	Gas Valve Lock Nut for 58865 and 58953..
1660D	9271	Tension Wheel Brake Connection Spring Thumb Nut.....
1662C	-----	Feed Regulating Adjusting Screw Nut for 58958.....
1736C	9284	Needle Bar Connecting Link Crank (inside) Hinge Screw Nut.....
1736C	9284	Needle Bar Connecting Link Crank (outside) Hinge Screw Nut.....
1741C	9284	Gas Valve Nut for 58865 and 58953.....
1768R	-----	Cord Connector Block Screw Nut for 192921 and 192922.....
1796E	7978	Under Driver Bell Tightener Screw Nut for 126590.....

## NUMERICAL LIST OF PARTS

No.	Plate	Name
2049	9266	Needle Guide (upper) Bar Bracket Pin....
2049	9266	Shuttle Race Back Position Pin for 58934
2102	9273	Bobbin Winder Wax Box Tension Disc for 58895.....
2102	9273	Wax Box Tension Disc for 58816 and 58978
2103	9273	" " " Spring for 58816 and 58978
2103	9273	Bobbin Winder Wax Box Tension Spring for 58895.....
2117	9255	Needle Bar Connecting Link Extension Pin for 58727.....
2117	9255	Shuttle Driver Pin.....
2718R	9278	Under Driver Treadle Extension Screw Washer for 126037.....
2762	3839	Foot Lifter Treadle Pitman Rod (lower) Spring Collar with 362C, for 46587..
2762	3839	Foot Lifter Treadle Pitman Rod (upper) Stop Collar with 362C, for 46587....
2762	3839	Treadle Pitman Rod (lower) Spring Collar with 362C, for 46587.....
2762	3839	Treadle Pitman Rod (upper) Stop Collar with 362C, for 46587.....
3012	9254	Needle Guide (lower) Rock Shaft Crank Pin.....
5868	-----	Oscillating Shaft Crank Slide Block com- plete, for 58762, Nos. 190E, 1054C, 5968 and 9119.....
5968	9254	Oscillating Shaft Crank Slide Block Cap Screw Washer for 5868.....
6055	9279	Machine Base Bolt Nut Washer for 97-1 and 97-6 Machines.....
8582	3839	Starting Shaft Bracket Dowel Pin for 25275 and 25276.....
8582	3839	Treadle Shaft Bracket Dowel Pin for 25274.....
8787	9271	Tension Regulating Thumb Nut Washer for 58796.....
8859	3839	Band Wheel Shaft Crank Pin for 25274....
8873	9270	Feed Shaft Crank (front) Pin.....
8908	9277	Wrench for 1520 (Accessories).....
8961	9266	Shuttle Cylinder Hinge Pin for 58786, ob- solete, use 58527.....
8983	9273	Thread Take-up Cam Pin.....
8987	3835	Friction Washer (paper) for 25275 and 25276.....
9079	3839	Foot Lifter Treadle Pitman Rod Clamp with 354C, for 46587, obsolete, use 80223.....
9079	3839	Treadle Pitman Rod Clamp with 354C, for 46587, obsolete, use 80223.....
9079	3839	Under Driver Treadle Pitman Rod Clamp with 354C, for 60626, obsolete, use 80223.....

## NUMERICAL LIST OF PARTS

No.	Plate	Name
9119	9254	Oscillating Shaft Crank Slide Block for 5868.....
11166	9262	Oscillating Rock Shaft Oil Pad for 58757
11226	9283	Thread Unwinder Thread Roller Guide Pin for 60208.....
11241	9271	Tension Friction Washer (felt) for 58796
11393	9254	Oscillating Shaft Collar with two 453C, for 97-6 to 97-10 Machines.....
11466	3839	Foot Lifter Treadle Pitman Rod (lower) Spring Washer for 46587.....
11466	3839	Motor Starting Box Board Bolt Washer for 25276.....
11466	3839	Treadle Pitman Rod (lower) Spring Washer for 46587.....
11831	9277	Screw Driver (large) Accessories.....
11864	9281	Under Driver Shaft Driving Pulley (sec- tional) 10 in. diam., 1 1/4 in. face, 1 3/16 in. bore, with two 597C, for 126591.....
11910	9266	Shuttle Bobbin for 58786.....
12002	9266	" Cylinder Latch Pin for 58891....
12620	3837	Base Screw Washer for 25274.....
14129	9270	Arm Front Cover Washer for 97-6 to 97-10 Machines.....
16036	9253	Arm Side Cover.....
16922	3839	Column Dowel Pin for 25274 to 25276....
16922	3839	Treadle (left) Pin for 25274.....
16922	3839	" Shaft Arm Pin for 25274.....
17547	9278	Bobbin Winder Wax Box Tension Thread Guide for 58895.....
19684	9271	Tension Friction Washer (steel) for 58796.....
19686	9271	Tension Spring for 58796.....
19869	9254	Shuttle Cylinder Latch Spring for 58891.
21346	9259	Presser Bar Spring Stud.....
21788	9266	Shuttle Race Spring for 58938.....
23258	9278	Under Driver Treadle Bracket (left) Hook Friction Washer for 126206.....
25030	9278	Belt Hook for 46669 and 46670.....
25274	-----	Column Stand complete for 97-2 and 97-7 Machines, Nos. 9D, 344C, 46555, 46557, 46559, 46562, 46564 to 46576, 46583, 46587, 46653, two each 8582, 8859, 46556, 46561, 46650, 46651, 50283E, three each 494E, 12620, 50347E, four each 16922, 46647, 46652, 50309E, eight 1506E and twelve 1186D.....

## NUMERICAL LIST OF PARTS

No.	Plate	Name
25275	-----	Column Stand complete for 97-3 and 97-8 Machines, Nos. 9D,344C,524C,1304C, 1509C, 1513J, 8987, 46562 to 46570, 46575 to 46583, 46587, 46589, 46591 to 46600,46654,50313C, two each 795C, 865C,1237E,1614E,8582,16922,46560, 46650,50283E, three each 494E, 731E, 46557, four each 50309E, 50347E and eight 1506E.....
25276	-----	Column Stand complete for 97-4,97-5,97-9 and 97-10 Machines,Nos.9D,344C,524C, 1304C, 1509C, 1513J, 8987, 46562 to 46569, 46575, 46577 to 46581, 46583, 46587, 46589, 46591 to 46600, 46610, 46611,46654,50313C,79624, two each 795C,865C,1237E,1614E,8582,16922, 46560,46576,46650,50283E, three each 494E,731E,11466,46557,51070E, four each 50309E, 50347E and eight 1506E.
25303	7978	Under Driver Driving Pulley Shaft Ball, size 1/4 in.,for 126576.....
25362	7978	Under Driver Friction Pulley Ball, size 3/16 in., for 227553.....
26026	9277	Screw Driver, medium (Accessories)....
26485	9277	" " small (Accessories)....
27555	9283	Thread Unwinder Spool Pin for 60208.....
27557	9283	" " Stand with 138E, for 60931
27639	9275	Under Driver Treadle Pitman Rod for 60626.....
27662	9277	Wrench for 1508 and 1619 (Accessories)
27797	9279	Bobbin Winder Gear Handle (wood) for 58825.....
27799	9279	Bobbin Winder Gear Handle Stud Washer for 58825.....
36221	9262	Guide, 1 1/4 in. face.....
36891	9262	" 1 1/2 in. face.....
40063	7980	Under Driver Frame Hinge Pin for 126590.
43945	9271	Tension Wheel Brake Connection Spring...
46555	3834	Band Wheel, two speed, 15 1/4 in. and 17 1/4 in.diam.,with 344C, for 25274
46556	3836	Band Wheel Pitman with four 129E, for 25274.....
46556	3836	Treadle (right) Pitman with four 129E, for 25274.....
46557	3839	Foot Lifter Treadle Stud for 25274 to 25276.....
46557	3839	Starting Treadle Connecting Link Hinge Stud for 25275 and 25276.....
46557	3839	Treadle Stud for 25274 to 25276 and 58842.....

## NUMERICAL LIST OF PARTS

No.	Plate	Name
46558	9279	Bobbin Winder Gear Hinge Stud for 58834 and 58974.....
46559	3836	Band Wheel Shaft for 25274.....
46560	3837	Balance Wheel Shaft Bushing for 25275 and 25276.....
46561	3636	Band Wheel Shaft Crank with 858C, for 25274.....
46562	-----	Base for 25274 to 25276.....
46563	-----	Column for 25275 and 25276.....
Nos. 46564 to 46569, for 25274 to 25276		
46564	3834	Column Extension.....
46565	3834	Table 46697 with 46698 and two 731E....
46566	3836	" " Latch.....
46567	3837	" " Spring.....
46568	3836	" " Shaft with 453C.....
46569	3838	" " Collar with 445C.....
46570	3834	Tray for 25274 and 25275.....
Nos. 46571 to 46574, for 25274		
46571	3834	Treadle (left) with 344C.....
46572	3834	" (right) with 858C.....
46573	3834	" " Shaft.....
46574	3834	" " Arm with 344C and 858C....
46575	3834	Starting Shaft Bracket for 25275 and 25276.....
46575	3834	Treadle Shaft Bracket for 25274.....
46576	3838	Balance Wheel Shaft Collar with two 445C, for 25276.....
46576	3838	Countershaft Pulley Shaft Collar with two 445C, for 46603.....
46576	3838	Starting Shaft Collar with two 445C, for 25275 and 25276.....
46576	3838	Treadle Shaft Collar with two 445C, for 25274.....
Nos. 46577 to 46581, for 25275 to 25276		
46577	3835	Balance Wheel with 344C.....
46578	3836	" " Shaft.....
46579	3838	" " Stop Screw Bracket..
46580	3835	Driving Arm.....
46581	3835	" " Bracket.....
46582	3835	Countershaft Pulley, 8 in. diam., with two 344C, for 46603.....
46582	3835	Driving Pulley, 8 in. diam., with two 344C, for 25275.....
46583	3835	Foot Lifter Treadle with 858C, for 25274 to 25276.....

## NUMERICAL LIST OF PARTS

No.	Plate	Name
46583	3835	Treadle with 858C, for 25274 to 25276 and 58841.....
Nos. 46584 to 46586, for 46587		
46584	3835	Foot Lifter Treadle Pitman Rod (lower)..
46584	3835	Treadle Pitman Rod (lower).....
46585	3837	Foot Lifter Treadle Pitman Rod (lower) Spring.....
46585	3837	Treadle Pitman Rod (lower) Spring.....
46586	3835	Foot Lifter Treadle Pitman Rod (upper)..
46586	3835	Treadle Pitman Rod (upper).....
46587	-----	Foot Lifter Treadle Pitman complete for 58842, Nos. 11466, 46584 to 46586, 80223 and two 2762.....
46587	-----	Treadle Pitman complete for 25274 to 25276, Nos. 11466, 46584 to 46586, 80223 and two 2762.....
Nos. 46589 to 46600, for 25275 and 25276		
46589	3835	Friction Pulley with 46590.....
46590	3838	" " Bushing for 46589.....
46591	3839	" " Center Plug (wood).....
46592	3837	" " Spring.....
46593	3836	Starting Shaft.....
46594	3835	" " Arm with two 731E, for 46580
46595	3835	" " with two 731E, for 46597
46596	3838	" " Collar with 731E.....
46597	3835	" Treadle.....
46598	3838	" " Connecting Link with two 858C.....
46599	3837	Starting Treadle Shaft.....
46600	3835	" " Stand with two 438C....
46601	3835	Countershaft Hanger for 46603.....
46602	3836	" Pulley Shaft for 46603.....
46603	-----	Countershaft complete for 25275, Nos. 46576, 46601, 46602, two 46582 and three 50215E.....
Nos. 46606 to 46609, for 46610		
46606	3836	Belt Tightener Pulley.....
46607	3836	" " " Arm.....
46608	3837	" " " Spring.....
46609	3835	Motor Base.....
46610	-----	Motor Base complete for 25276, Nos. 46606 to 46609, two 1405E, three 50215E and four 1062E.....
46611	3834	Tray for 25276.....

## NUMERICAL LIST OF PARTS

No.	Plate	Name
46647	3839	Band Wheel Pitman Ball Stud (lower) for 25274.....
46647	3839	Band Wheel Pitman Ball Stud (upper) for 25274.....
46647	3839	Treadle (right) Pitman Ball Stud (lower) for 25274.....
46647	3839	Treadle (right) Pitman Ball Stud (upper) for 25274.....
46650	3839	Balance Wheel Shaft Oil Cup for 25275 25276.....
46650	3839	Band Wheel Shaft Oil Cup for 25274.....
Nos. 46651 to 46653, for 25274		
46651	3837	Band Wheel Shaft Roller Bearing.....
46652	3838	" " " " " Cap....
46653	-----	Column.....
46654	3837	Starting Treadle Spring for 25275 and 25276.....
46669	-----	Belt, size 3/8 in., length 117 in., with 25030, for 25274.....
46670	-----	Belt, size 3/8 in., length 108 in., with 25030, for 25275 and 25276.....
46681	9282	Under Driver Treadle Bracket (right) for 60502.....
46697	9286	Table for 46565.....
46698	9286	" Bracket for 46565.....
50058D	7978	Under Driver Belt Guard Screw for 126791
50215E	3840	Motor Base Screw for 46610.....
50215E	3840	Countershaft Hanger Screw for 46603.....
50262D	9272	Arm Shaft Screw.....
50263C	9284	Feed Regulator Adjusting Screw for 58714 and 58958.....
50264C	9285	Feed Regulator Adjusting Stud.....
50265C	9284	Needle Bar Connecting Link Crank (inside) Hinge Screw.....
50265C	9284	Needle Bar Connecting Link Crank (outside) Hinge Screw.....
50266C	9285	Needle Bar Connecting Link Extension Hinge Screw.....
50267C	9284	Needle Bar Frame Connection Adjusting Screw for 58735.....
50268C	9285	Needle Bar Frame Connection Hinge Screw.
50269F	9255	" Clamp Screw for 58739.....
50270C	9266	Shuttle Race Cover Lock Screw for 58794.
50271C	9271	Tension Screw Stud for 58796.....
50272C	9284	Thread Take-up Cam Position Screw for 58804 and 58941, obsolete.....
50273C	9284	Thread Take-up Lever Hinge Screw.....
50283E	3840	Starting Shaft Bracket Screw for 25275 and 25276.....



## NUMERICAL LIST OF PARTS

No.	Plate	Name
50283E	3840	Treadle Shaft Bracket Screw for 25274...
50288C	7978	Under Driver Belt Tightener Screw Hinge Stud Set Screw for 126583.....
50288C	7978	Under Driver Frame Hinge Pin Set Screw for 126583.....
50309E	3837	Column Extension Screw Stud for 25274 to 25276.....
50310E	9278	Bobbin Winder Wax Box Tension Thread Stripper Regulating Screw Stud for 58895.....
50313C	3841	Driving Arm Adjusting Screw for 25275 and 25276.....
50347E	3840	Column Screw for 25274 to 25276.....
50347E	3840	Driving Arm Bracket Screw for 25275 and 25276.....
50430	9285	Wax Box Thread Guide Roller Screw for 58816 and 58978.....
50431	9285	Wax Box Thread Stripper (lower) Arm Hinge Screw for 58816 and 58978....
50456C	9266	Shuttle Race Cover Lock Screw for 58951.
50512E	7978	Under Driver Pulley Screw for 126179....
50577R	-----	Cord Connector Block Screw for 192921 and 192922.....
50581R	9278	Under Driver Treadle Extension Screw for 126037.....
50959C	7978	Under Driver Driving Pulley Shaft Set Screw for 126586.....
51067C	7978	Under Driver Brake Lever Set Screw for 126574.....
51070E	3840	Motor Starting Box Board Bolt with 51581E, for 25276.....
51077E	9279	Machine Base Bolt with 51581E, for 97-1 and 97-6 Machines.....
51224J	-----	Arm Side Cover Thumb Screw.....
51581E	9279	Machine Base Bolt Nut for 51077.....
51581E	3841	Motor Starting Box Board Bolt Nut for 51070.....
51805	9259	Presser Bar Clutch Lifting Stud Roller for 58770.....
51806	9273	Thread Take-up Lever Roller and Screw Stud with 1608C, for 58806 and 58944
55612	9266	Shuttle Race Cover Hinge Pin for 58794 and 58951.....
55767	7978	Under Driver Belt Tightener Screw Hinge Stud for 126590.....
58527	-----	Shuttle Cylinder Hinge Pin, for 58786....
58626	-----	" " Latch for 58891.....
*58701	-----	Arm and Cylinder.....
58702	9252	" Front Cover for 97-1 to 97-5 Machines.....

## NUMERICAL LIST OF PARTS

No.	Plate	Name
58703	9270	Arm Front Cover Spring.....
58704	9270	" Oil Tube, for intermediate bearing..
58705	9251	" Shaft, obsolete.....
58706	9253	" " Bushing (intermediate).....
58707	9251	" " Flanged Bushing (back).....
58708	9253	" " " (front).....
58709	9281	Balance Wheel with two 344C, for 97-1, 97-3 to 97-6 and 97-8 to 97-10 Machines.....
58710	9251	Crank Connecting Rod with two 129E.....
58712	9252	Face Plate for 97-1 to 97-5 Machines....
58713	9253	Feed Cam (double) with two 858C.....
58714	9252	" Regulator with 1065C and 50263C....
58715	9270	" " Adjusting Stud Nut Washer
58716	9270	" " " Sleeve....
58717	9253	" " Connection.....
58718	9253	" " Shaft.....
58719	9270	" " " Collar with two 858C
58720	9251	" Shaft.....
58721	9270	" " Collar (back) with two 858C..
58722	9270	" " " (front) with two 858C.
58723	9253	" " Crank (back) with four 1396D.
58724	9253	" " " (front) with 858C and 1396D.....
58725	9258	Needle Bar (hollow) with 58755, for 97-1 to 97-5 Machines.....
58727	-----	Needle Bar Connecting Link with 2117, 58731 and 58732, for 58988.....
58728	9258	Needle Bar Connecting Link Crank (inside) with 1186C.....
58729	9258	Needle Bar Connecting Link Crank (outside) for 58988.....
58730	9255	Needle Bar Connecting Link Crank (outside) Gib for 58729, obsolete.....
*58731	9270	Needle Bar Connecting Link Extension for 58727.....
58732	9270	Needle Bar Connecting Link Extension Dowel Pin for 58727.....
58733	9262	Needle Bar Connecting Stud with two 1186D, for 97-1 to 97-5 Machines....
58734	9251	Needle Bar Frame for 97-1 to 97-5 Machines.....
58735	9258	Needle Bar Frame Connection with 50267C.
58736	9254	" " " " " ARM.....
58737	9255	" " " " " Slide Block.
Nos. 58738 to 58740, for 97-1 to 97-5 Machines		
58738	9258	Needle Bar Spring.....
58739	9255	" Clamp with 50269F.....

## NUMERICAL LIST OF PARTS

No.	Plate	Name
58740	-----	Needle Guide (lower) for No. 27 Needle..
58741	9251	" " " " Rock Shaft.....
58742	9254	" " " " " Back Bear- ing Oil Tube.....
58742	9254	Oscillating Shaft Back Bearing Oil Tube.
58743	9274	Needle Guide (lower) Rock Shaft Crank with two 1396D.....
58744	9257	Needle Guide (lower) Rock Shaft Crank Connecting Rod.....
58745	9254	Needle Guide (lower) Rock Shaft Front Bearing Oil Tube.....
58745	9254	Oscillating Shaft Front Bearing Oil Tube
Nos. 58746 to 58750, for 97-1 to 97-5 Machines		
58746	-----	Needle Guide (upper) with 1186C, for No. 27 Needle.....
58747	9258	Needle Guide (upper) Bar.....
58748	9257	" " " " " Bracket with two 1177C, for 97-1 to 97-5 Machines, ob- solete.....
58749	9254	Needle Guide (upper) Bar Bracket Cushion
58750	9272	" " " " " Slide Block for 97-1 to 97-5 Machines, ob- solete, use 58919.....
58751	9254	Needle Guide (upper) Bar Bracket Slide Block Cushion.....
58752	8206	Needle Plate (wide) medium needle hole..
58753	-----	" " " " " small needle hole...
58754	9257	" " " " " Holder with 114D, for 97-1 to 97-5 Machines.....
58755	9262	Needle Stop Pin for 58725 and 58964.....
58757	-----	Oscillating Rock Shaft complete, Nos. 11165 and 58758.....
58758	9257	Oscillating Rock Shaft Hinge Pin for 58757.....
58759	9254	Oscillating Rock Shaft Oil Tube.....
58760	9251	" Shaft for 97-1 to 97-5 Machines
58761	9254	" " Crank for 58762.....
58762	-----	Oscillating Shaft Crank complete, Nos. 1396D, 5868, 58761 and two 1177D....
58764	9251	Presser Bar.....
58765	9272	" " Clutch for 97-1 to 97-5 Ma- chines, obsolete, use 58927.....
58766	9259	Presser Bar Clutch Clamp for 58990.....
58767	9259	" " " " Cushion.....
58768	9259	" " " " Lever for 58990.....
58769	9259	" " " " Lifting Lever.....
58770	9259	" " " " Stud with 428C and 51805.....

## NUMERICAL LIST OF PARTS

No.	Plate	Name
58771	9272	Presser Bar Clutch Spring, obsolete....
58772	9263	" " Guide Bracket with two 1396D
58773	9263	" " " " Guide Stud....
58774	9275	" " Spring (flat) long.....
58775	9275	" " " " short.....
58776	9263	" " " Bracket with two 1186D, obsolete, use 58836.....
58777	9263	Presser Bar Spring Bracket Extension....
58778	9263	" " " Guide.....
58780	9264	" Foot (stitch set) 6 stitches to the inch.....
58781	9266	Presser Foot Holder with 1177D, for 97-1 to 97-5 Machines.....
58782	9266	Shuttle Cylinder for 58890.....
58783	9266	" " Latch for 58891, obso- lete.....
58784	9267	Shuttle Frame for 58891.....
58785	9266	" Tension Spring for 58890.....
58786	9267	Shuttle (cylinder) 3 in. diam., com- plete, Nos. 11910, 58527, 58890 and 58891.....
58787	9258	Shuttle Driver with 453C.....
Nos. 58788 and 58789, for 58794		
*58788	9268	Shuttle Race with 1019C.....
58789	9269	" " Cover.....
58790	9266	" " " Hinge Pin for 58794, obsolete.....
58791	9269	Shuttle Race Ring for 97-1 to 97-5 Ma- chines.....
58792	9266	Shuttle Race Ring Steady Pin for 97-1 to 97-5 Machines.....
58793	9266	Shuttle Race Spring for 58794.....
58794	-----	Shuttle Race complete for 97-1 to 97-5 Machines, Nos. 55612, 58788, 58789 and two each 26D, 50270C and 58793.....
58795	9271	Tension Wheel for 58796.....
58796	-----	Tension (wheel) complete, Nos. 1535E, 8787, 19684, 19686, 50271C, 58795 and two 11241.....
58797	9271	Tension Wheel Brake with 174E.....
58798	9271	" " " Connection.....
58799	9271	" " " Hinge Screw Bushing.
58800	9271	Bobbin Winder Wax Box Tension Thread Guide Roller for 58895.....
58800	9271	Thread Guide Roller (side of arm).....
58800	9271	" Take-up Lever Thread Guide Roller (back) for 58806 and 58944.....
58800	9271	Thread Take-up Lever Thread Guide Roller (front) for 58806 and 58944.....



## NUMERICAL LIST OF PARTS

No.	Plate	Name
58853	-----	Gas Burner 58852 with 58849, for 58865 and 58953.....
Nos. 58854 to 58858, for 58865 and 58953		
58854	9256	Gas Burner Pipe (brass) with 58859, for 58786.....
58855	9256	Gas Burner Pipe (brass) with 58859, for 58796.....
58856	9255	Gas Burner Pipe (brass) with 58859, for 58816.....
58857	9256	Gas Burner Pipe Bracket.....
58858	9255	" " " Coupling.....
58859	9255	" " " Sleeve for 58854 to 58856
Nos. 58860 to 58863, for 58865 and 58953		
58860	9256	Gas Pipe.....
58861	9255	" " " Elbow.....
58862	9255	" " " Nipple.....
58863	9255	" Valve with 58864.....
58864	9255	" " Handle for 58863.....
58865	-----	Gas (artificial) Heating Attachment complete, for 97-1 to 97-5 Machines, Nos. 58854 to 58857, 58860 to 58862, 58866, 58867, two each 210D, 1186D and three each 1654C, 1741C, 58853, 58858 and 58863.....
58866	9255	Flame Protector for 58786, for 58865 and 58953.....
58867	9256	Heating Plate for 58796, for 58865.....
58868	9270	Feed Shaft Crank (back) Key.....
Nos. 58869 to 58878, for 97-1 to 97-5 Machines		
58869	9260	Needle Guide (lower) for No. 23 Needle..
58870	-----	" " " " No. 24 Needle..
58871	-----	" " " " No. 25 Needle..
58872	-----	" " " " No. 26 Needle..
58873	-----	" " " " No. 28 Needle..
58874	9260	Needle Guide (upper) with 1186C, for No. 23 Needle.....
58875	-----	Needle Guide (upper) with 1186C, for No. 24 Needle.....
58876	-----	Needle Guide (upper) with 1186C, for No. 25 Needle.....
58877	-----	Needle Guide (upper) with 1186C, for No. 26 Needle.....
58878	-----	Needle Guide (upper) with 1186C, for No. 28 Needle.....

## NUMERICAL LIST OF PARTS

No.	Plate	Name
58879	9264	Presser Foot (stitch set) 5 stitches to the inch.....
58880	9264	Presser Foot (stitch set) 7 stitches to the inch.....
58881	9264	Presser Foot (stitch set) 8 stitches to the inch.....
58882	9265	Presser Foot (stitch set) 9 stitches to the inch.....
58883	9265	Presser Foot (stitch set) 10 stitches to the inch.....
58884	9265	Presser Foot (stitch set) 11 stitches to the inch.....
58885	9265	Presser Foot (stitch set) 12 stitches to the inch.....
58886	9273	Thread Take-up Spring.....
58887	8206	Presser Foot (double toe).....
58888	9277	Stitch Spacing Gauge (Accessories)....
58889	9264	Presser Foot (closed toe).....
*58890	-----	Shuttle Cylinder 58782 with 773F and 58785, for 58786.....
58891	-----	Shuttle Frame 58784 with 12002, 19869 and 58626, for 58786.....
58892	9261	Needle Plate (narrow) large needle hole, for leather bags, suit cases, etc...
58893	9272	Wax Box Thread Guide Roller for 58816 and 58978.....
58894	9272	Wax Box Thread Guide Roller Cover for 58816 and 58978.....
58895	-----	Bobbin Winder Wax Box Tension Bracket 58832 with 916C, 1042C, 1560C, 2103, 17547, 50310E, 58800, 58833 and two 2102, for 58834 and 58974.....
58896	9252	Arm Front Cover for 97-6 to 97-10 Machines.....
58897	9252	Face Plate for 97-6 to 97-10 Machines...
58898	9256	Heating Plate for 58796, for 58953.....
Nos. 58899 to 58920, for 97-6 to 97-10 Machines		
58899	9258	Needle Bar for 58900.....
58900	-----	" " 58899 with 1186F and 58903...
58901	9262	" " Connecting Stud with two 1186D
58902	9251	" " Frame.....
58903	9255	" " Clamp for 58900.....
58904	9260	" " Guide (lower) for No. 23 Needle..
58905	-----	" " " " No. 24 Needle..
58906	-----	" " " " No. 25 Needle..
58907	-----	" " " " No. 26 Needle..
58908	-----	" " " " No. 27 Needle..
58909	-----	" " " " No. 28 Needle..
58910	9260	" " (upper) with 1186C, for No. 23 Needle.....

## NUMERICAL LIST OF PARTS

No.	Plate	Name
58911	-----	Needle Guide (upper) with 1186C, for No. 24 Needle.....
58912	-----	Needle Guide (upper) with 1186C, for No. 25 Needle.....
58913	-----	Needle Guide (upper) with 1186C, for No. 26 Needle.....
58914	-----	Needle Guide (upper) with 1186C, for No. 27 Needle.....
58915	-----	Needle Guide (upper) with 1186C, for No. 28.....
58916	9251	Needle Guide (upper) Bar (hollow).....
58917	9257	" " " " Bracket with two 1177C, for 97-6 to 97-10 Machines, obsolete.....
58918	9254	Needle Guide (upper) Bar Bracket Cushion
58919	9272	" " " " " Slide Block for 97-6 to 97-10 Machines, obsolete.....
58920	9256	Needle Guide (upper) Bar Spring.....
58921	-----	" Plate (large needle hole).....
58922	9260	" " (raised at needle hole)....
58923	9261	" " (short end).....
58924	9260	" " (thick).....
58925	9257	" " Holder with 114D, for 97-6 to 97-10 Machines.....
58926	9251	Oscillating Shaft for 97-6 to 97-10 Machines.....
58927	9259	Presser Bar Clutch with 457C and 1342E, for 58990.....
58928	9259	Presser Bar Clutch Lever Hinge Pin for 58927.....
58929	9265	Presser Foot (toe at left of needle)....
58930	9265	" " (toe at right of needle)....
58931	9265	" " (toe at left and front of needle).....
58932	9266	Presser Foot Holder with 1177D, for 97-6 to 97-10 Machines.....
*58933	9268	Shuttle Race with 461C and 58947, for 58951.....
58934	9268	Shuttle Race Back with 2049, for 58938..
58935	9269	" " Cover for 58951.....
58936	9266	" " " Lock Screw Bushing for 58951.....
58937	9269	Shuttle Race Ring for 58938.....
Nos. 58938 to 58941, for 97-6 to 97-10 Machines		
58938	-----	Shuttle Race complete, Nos. 58934,58937, 58951, two 1394D and three 21788....
58939	9273	Thread Retainer Plate (lower).....
58940	9273	" " " (upper).....
58941	9275	" Take-up Cam with 50272C, for 58705, obsolete.....

## NUMERICAL LIST OF PARTS

No.	Plate	Name
58942	9273	Thread Take-up Cam Support.....
58943	9274	" " Lever for 58944.....
58944	-----	Thread Take-up Lever complete for 97-6 to 97-10 Machines, Nos. 51806,58801, 58807, 58943 and two each 1042C and 58800.....
58945	9260	Needle Plate, for edge stitching hand bags.....
58946	9265	Presser Foot, for edge stitching hand bags.....
58947	9266	Shuttle Race Ring Position Stud for 58933.....
58948	9263	Presser Bar Clutch Spring.....
58949	9263	" " " " Bracket with 58950.....
58950	9259	Presser Bar Clutch Spring Stud for 58949
58951	-----	Shuttle Race 58933 with 442C, 55612, 58935, two each 171D, 50456C and 58936, for 58938.....
58952	9264	Presser Foot (stitch set) 4 stitches to the inch.....
58953	-----	Gas (artificial) Heating Attachment complete for 97-6 to 97-10 Machines, Nos. 58854 to 58857, 58860 to 58862, 58866,58898, two each 210D,1186D and three each 1654C,1741C, 58853, 58858 and 58863.....
58954	9251	Arm Shaft.....
58955	9275	Thread Take-up Cam with 429C, for 97-1 to 97-5 Machines.....
58956	9275	Thread Take-up Cam with 429C, for 97-6 to 97-10 Machines.....
58957	9264	Presser Foot (stitch set) 3 stitches to the inch.....
58958	9252	Feed Regulator with 1065C, 1662C and 50263C.....
58959	9257	Needle Guide (upper) Bar Bracket with two 1177C, for 97-1 to 97-5 Machines
58960	9257	Needle Guide (upper) Bar Bracket with two 1177C, for 97-6 to 97-10 Machines.....
58961	9254	Needle Guide (upper) Bar Bracket Slide Block.....
58962	-----	Needle Plate (large needle hole) 3 stitches to the inch.....
58963	9264	Presser Foot (double toe) 3 stitches to the inch.....
58964	9258	Needle Bar with 58755, for No. 31 Needle, for 97-1 to 97-5 Machines.....
Nos. 58965 to 58970, for 97-1 to 97-5 Machines		
58965	-----	Needle Guide (lower) for No. 31 Needle..

## NUMERICAL LIST OF PARTS

No.	Plate	Name
58966	-----	Needle Guide (upper) with 1186C, for No. 31 Needle.....
58967	-----	Needle Guide (lower) for No. 29 Needle..
58968	-----	Needle Guide (upper) with 1186C, for No. 29 Needle.....
58969	-----	Needle Guide (lower) for No. 30 Needle..
58970	-----	" " (upper) with 1186C, for No. 30 Needle.....
58971	9281	Bobbin Winder Base for 58980 and 58981..
58972	9283	" " Water Box with 58973, for 58981.....
58973	9282	Bobbin Winder Water Box Plug for 58972..
58973	9282	Wax Box Plug for 58977.....
58974	-----	Bobbin Winder complete (electrically heated) for 110 or 220 volts, Nos. 164D,167D,46558,58823,58825,58828 to 58831,58835,58895,58961,91363,192919 or 192920, two each 771D,wood screws 1 3/4 in. No. 14 and six 1396D.....
58975	9274	Heating Iron for 58976.....
58976	-----	Electric Heating Attachment complete for 110 or 220 volts, Nos. 58978, 192921 or 192922, two each 164D,1394D,58975 and 91363.....
58977	9276	Wax Box with 58973, for 58978.....
58978	-----	Wax Box complete for 58976, Nos. 199D, 836E,1110C,1423D,1560C,2103,50431, 58809 to 58815, 58977, two 2102 and three each 181D, 50430, 58893 and 58894.....
58979	9266	Shuttle Cylinder Latch for 58891, obsolete, use 58626.....
58980	-----	Base 58971 with 58850, 58851 and six 1396D, for 58834.....
58981	-----	Base 58971 with 58850, 58972 and six 1396D, for 58974.....
*58988	-----	Needle Bar Connecting Link complete,Nos. 58727 and 58729.....
58989	-----	Presser Bar Guide Bracket Spacing Washer
58990	-----	" " Clutch 58927 with 1354C, 1467H,1520E,58766,58768 and 58928... Nos. 60201 to 60207, for 60208
60201	9283	Thread Unwinder Rod.....
60202	9283	" " Spool Rest with 138E....
60203	9283	" " Thread Guide (cone).....
60204	9283	" " " " Arm with two 447C.....
60205	9283	Thread Unwinder Thread Roller Guide with 452C.....
60206	9278	Thread Unwinder Thread Roller Guide Pin Collar with 620C.....

## NUMERICAL LIST OF PARTS

No.	Plate	Name
60207	9283	Thread Unwinder Thread Straightener with 452C.....
60208	9283	Thread Unwinder complete, for one large spool or one large cone of thread, for 60931 and for 97-2 to 97-5 and 97-7 to 97-10 Machines, Nos. 11226, 27555, 58800 and 60201 to 60207.....
60502	-----	Under Driver Treadle Bracket (right) 46681 with two wood screws 1 in. No. 14, for 126211.....
60626	9275	Under Driver Treadle Pitman complete for 126212, two each Nos. 27639 and 80223.....
60823	-----	Brake Lever Adjusting Screw 423C with 1520R.....
60858	9282	Under Driver Treadle Hanging Hook for 126212.....
60911	7877	Under Driver Driving Pulley Friction Ring (leather) for 126169.....
60931	-----	Thread Unwinder 60208 with 27557 and three wood screws 1 1/4 in. No. 12, for one large spool or one large cone of thread, for 97-1 and 97-6 Machines.....
60935	7978	Under Driver Driving Pulley Friction Ring Stop Pin for 126169.....
67090	9280	Bobbin Winder Cord with 192540, for 192919 and 192920, obsolete.....
67090	9280	Cord with 192540, for 192921 and 192922, obsolete.....
79624	3834	Motor Starting Box Board for 25276.....
80223	-----	Foot Lifter Treadle Pitman Rod Clamp with 361C, for 46587.....
80223	-----	Treadle Pitman Rod Clamp with 361C, for 46587.....
80223	-----	Under Driver Treadle Pitman Rod Clamp 361C, for 60626.....
91363	9278	Bobbin Winder Cord Strap for 58974.....
91363	9278	Cord Strap for 58976.....
120104	9262	Guide, 3/4 in. face, for 97-6 to 97-10 Machines.....
120341	9277	Tweezers, curved (Accessories).....
120344	9277	Oiler (copper plated) with 120345 (Accessories).....
120345	9277	Oiler Spout, 5 in. long, for 120344.....
120571	9277	Shuttle Cylinder Opener for 58786 (Accessories).....
123183	7978	Under Driver Lever Shaft Cotter Pin for 126590.....
126036	9281	Under Driver Treadle for 126037.....

## NUMERICAL LIST OF PARTS

No.	Plate	Name
126037	-----	Under Driver Treadle 126036 with 2718R, 50581R and 126038, for 126211.....
126038	9275	Under Driver Treadle Extension for 126037.....
126169	7877	Under Driver Driving Pulley (right hand) 6 3/4 in. diam. with 60911, 60935, 126202 and two 126895, for 126590...
126173	7978	Under Driver Driving Pulley Shaft Oiling Leather for 126577.....
126175	7978	Under Driver Driving Pulley Shaft Oiling Leather Plug for 126577.....
126179	7877	Under Driver Friction Pulley (right hand) with 227553 and four 50512E, for 126590.....
126201	7979	Under Driver Driving Pulley Spring Retaining Washer for 126202.....
126202	-----	Under Driver Driving Pulley Spring Retaining Washer complete for 126169, Nos. 126201 and 126203.....
126203	7978	Under Driver Driving Pulley Spring Retaining Washer Pin for 126202.....
126205	9282	Under Driver Treadle Bracket (left) for 126206.....
126206	-----	Under Driver Treadle Bracket (left) complete, for 126211, Nos. 23258, 126205, 126207, 126208 and two wood screws 1 in. No. 14.....
126207	9278	Under Driver Treadle Bracket (left) Hook for 126206.....
126208	9278	Under Driver Treadle Bracket (left) Hook Rivet for 126206.....
126211	-----	Under Driver Treadle complete for 126212, Nos. 60502, 126037 and 126206.....
126212	-----	Under Driver Treadle and Pitman complete for 126591, Nos. 60626, 60858 and 126211.....
126572	7980	Under Driver Belt Guard for 126590.....
126573	7978	" " Brake (thermo) for 126590
126575	7980	" " Lever Spring for 126590
*126576	-----	" " Driving Pulley Shaft 126756 with 204107, 204108 and eleven 25303, for 126577.....
126577	-----	Under Driver Driving Pulley Shaft complete, for 126590, Nos. 126173, 126175, 126576, 126578 and 126757.....
126578	7980	Under Driver Driving Pulley Shaft Oil Wick for 126577.....
126580	9282	Under Driver Lever Shaft for 126590.....

## NUMERICAL LIST OF PARTS

No.	Plate	Name
		Nos. 126583 to 126589, for 126590
126583	7877	Under Driver Base with two 50288C.....
126584	7980	" " Belt Tightener Screw.....
126585	7979	" " " " Nut Washer.....
126586	7877	Under Driver Frame with 50959C.....
126587	-----	" " Pulley (flat) 3 in. diam...
126588	7877	" " " " 4 in. diam...
126589	-----	" " " " 5 in. diam...
126590	-----	Under Driver Transmitter (belt tightener) complete for 126591, Nos. 40083, 55767, 123183, 126169, 126179, 126572, 126573, 126575, 126577, 126580, 126583, 126584, 126586, 126588, 126791, 126792, 127000, 204113, two each 1796E, 126585 and three wood screws 1 3/4 in. No. 16
126591	-----	Under Driver (belt tightener) lever pressure (right hand) one speed (flat pulley) complete for 97-1 and 97-6 Machines, Nos. 11864, 126212, 126590.....
*126756	7877	Under Driver Driving Pulley Shaft (hollow) for 126576.....
126757	9278	Under Driver Driving Pulley Shaft Oiling Leather Clip for 126577.....
126791	-----	Brake Lever with 50058R, 51067C and two 60823, for 126590.....
126792	-----	Lever (compression) and Dress Guard with 200524C, 204117 and two 202845, for 126590.....
126895	-----	Under Driver Driving Pulley Spring for 126169.....
127000	-----	Brake Lever Separating Washer for 126590
140147J	-----	Thread Retainer Spring Screw.....
*190712	-----	Bobbin Winder Heater Cartridge (110 volts) for 190713.....
*190712	-----	Heater Cartridge (110 volts) for 190713.
190713	9280	Bobbin Winder Heater Cartridge 190712 with thirty-four 190719, for 192920.
190713	9280	Heater Cartridge 190712 with thirty-four 190719, for 192922.....
190714	-----	Bobbin Winder Heater Cartridge (220 volts) for 190715.....
190714	-----	Heater Cartridge (220 volts) for 190715.
190715	9280	Bobbin Winder Heater Cartridge 190714 with thirty-four 190719, for 192919.
190715	9280	Heater Cartridge 190714 with thirty-four 190719, for 192921.....
190719	9278	Bobbin Winder Heater Insulating Beads for 190713 and 190715.....
190719	9278	Heater Insulating Beads for 190713 and 190715.....

No.	Plate	Name
191198	-----	Cord Connector Block for 192921 and 192922.....
192540	9280	Bobbin Winder Cord Plug complete for 67090, Nos. 192541 to 192543, obsolete.....
192540	9280	Cord Plug complete for 67090, Nos.192541 to 192543, obsolete.....
192541	-----	Bobbin Winder Cord Plug Base for 192540, obsolete.....
192541	-----	Cord Plug Base for 192540, obsolete.....
192542	-----	Bobbin Winder Cord Plug Cap for 192540, obsolete.....
192542	-----	Cord Plug Cap for 192540, obsolete.....
192543	9279	Bobbin Winder Cord Plug Flash Disc (fibre) for 192540, obsolete.....
192543	9279	Cord Plug Flash Disc (fibre) for 192540.
192919	-----	Bobbin Winder Cord and Plug complete for 220-240 volts, for 58974, Nos.190715 and 195149.....
192920	-----	Bobbin Winder Cord and Plug complete for 105-125 volts, for 58974, Nos.190713 and 195149.....
192921	-----	Cord and Plug complete for 240 volts,for 58976, Nos. 195150, two each 1768R, 50577R, 191198 and three 190715.....
192922	-----	Cord and Plug complete for 105-125 volts, for 58976, Nos. 195150, two each 1768R,50577R, 191198 and three 190715.....
195149	-----	Cord with Plug complete for 192919 and 192920.....
195150	-----	Cord with Plug complete for 192921 and 192922.....
200524C	7978	Under Driver Lever (compression) and Dress Guard Set Screw for 126792....
202845	7978	Under Driver Lever Compression Plate Rivet for 126792.....
Nos. 204100 to 204102, for 227553		
204100	7979	Under Driver Friction Pulley Ball Bearing Cup.....
204101	7979	Under Driver Friction Pulley Ball Cap...
204102	7979	" " " " " Retaining Spring.....
204107	7979	Under Driver Driving Pulley Shaft Ball Cup for 126576.....
204108	7979	Under Driver Driving Pulley Shaft Ball Cup Cap for 126576.....
204113	7978	Under Driver Driving Pulley Shaft Thimble for 126590.....

No.	Plate	Name
204117	7979	Under Driver Lever Compression Plate for 126792.....
227553	-----	Under Driver Friction Pulley Ball Cup complete for 126179, Nos. 204100 to 204102 and thirteen 25362.....

**SINGER** Needles should be used  
in **SINGER** Machines  
These Needles and their Containers  
are marked with the  
Company's Trade Mark "**SIMANCO.\*\***" 1

Needles in Containers marked  
"**FOR SINGER MACHINES**"  
are **NOT SINGER** made needles. 2



SINGER Needles should be used  
in SINGER Machines  
These Needles and their Containers  
are marked with the  
Company's Trade Mark "SIMANCO.\*\*" 1

Needles in Containers marked  
"FOR SINGER MACHINES"  
are NOT SINGER made needles. 2

PLATE 3834—ONE-NINTH SIZE

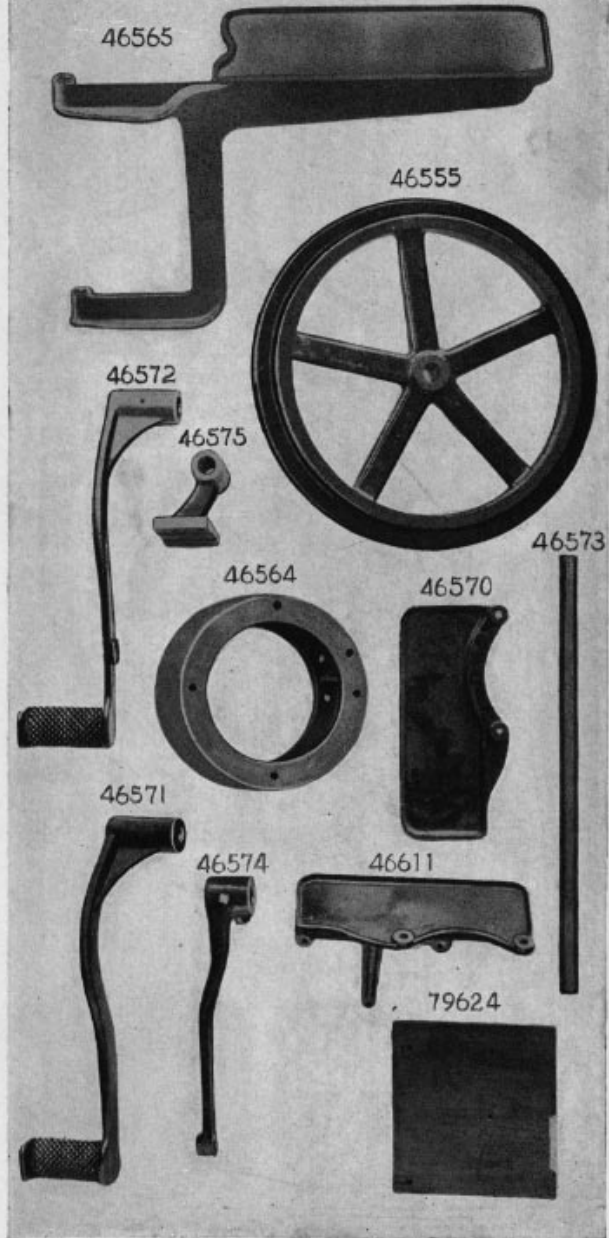


PLATE 3835—ONE-NINTH SIZE

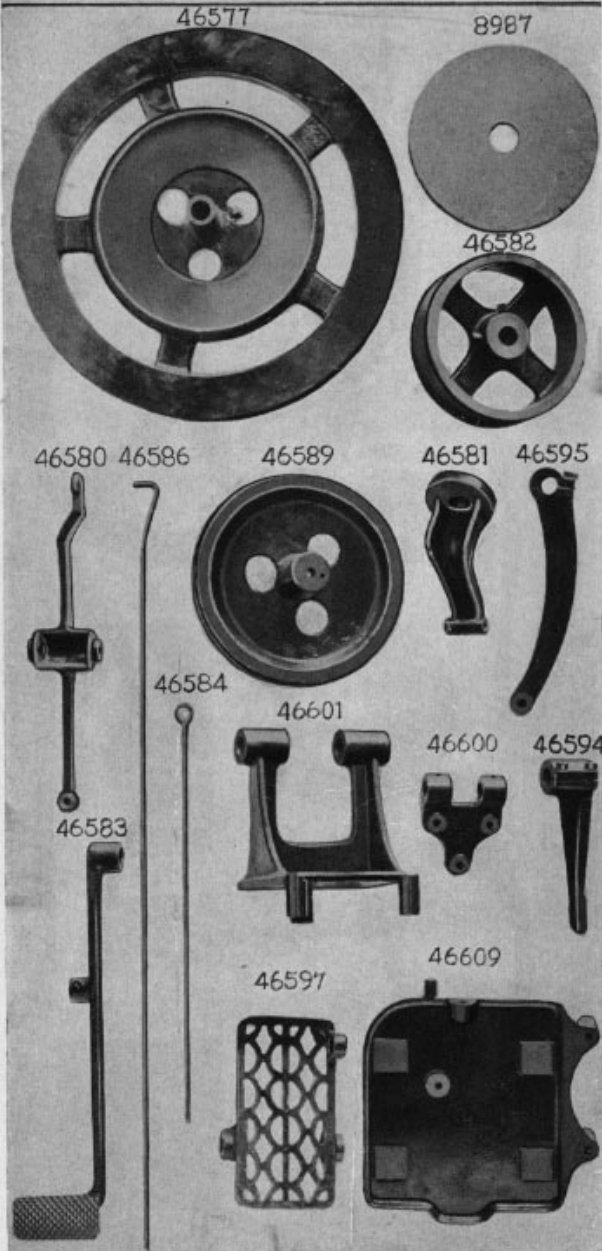


PLATE 3836—ONE-FOURTH SIZE

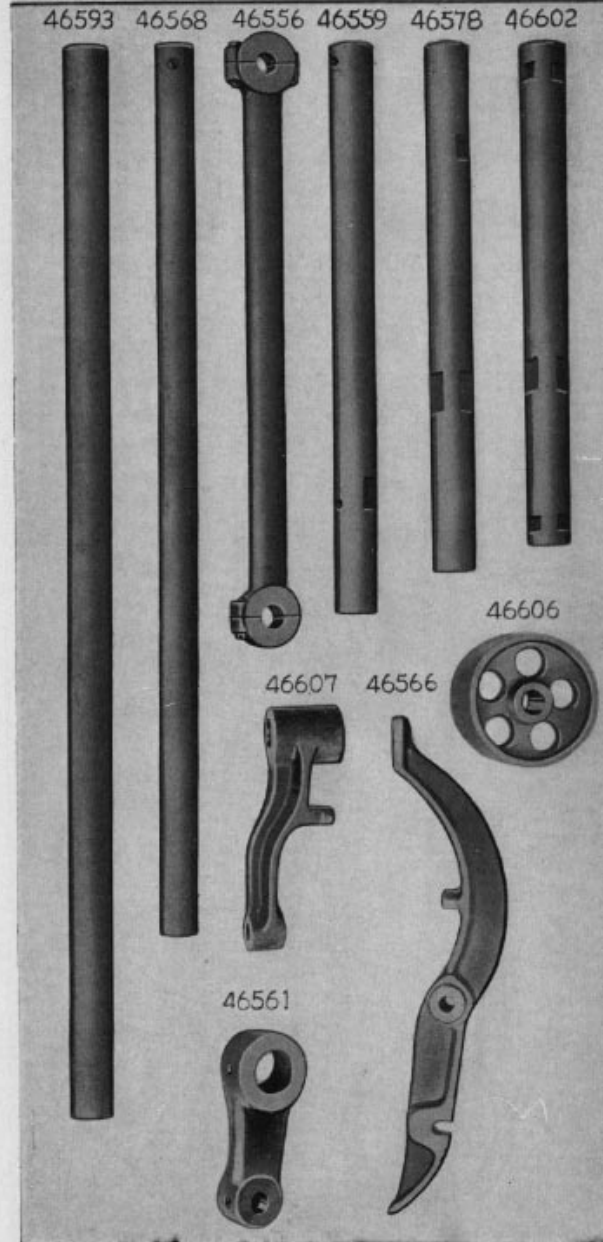
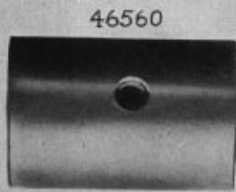


PLATE 3837—ONE-HALF SIZE



46654

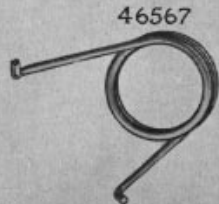
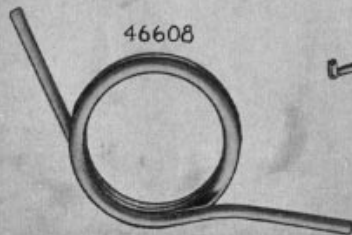
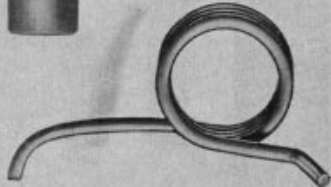


PLATE 3838—ONE-HALF SIZE

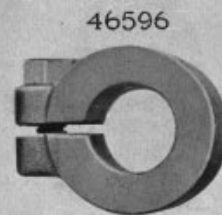
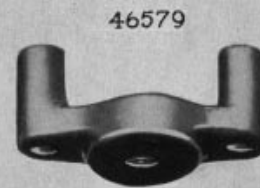
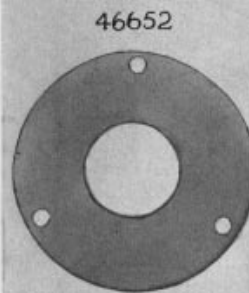


PLATE 3839—FULL SIZE

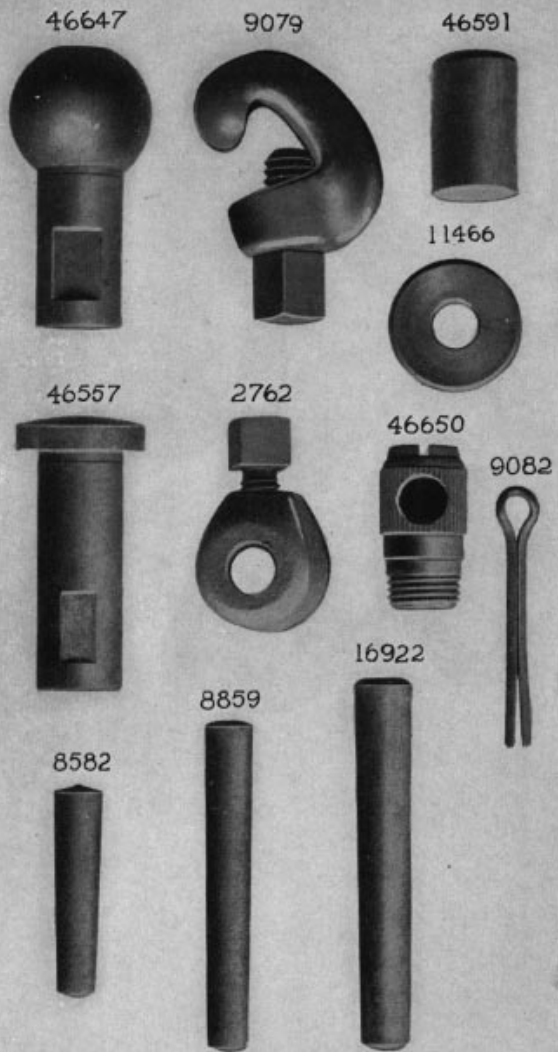


PLATE 3840—FULL SIZE

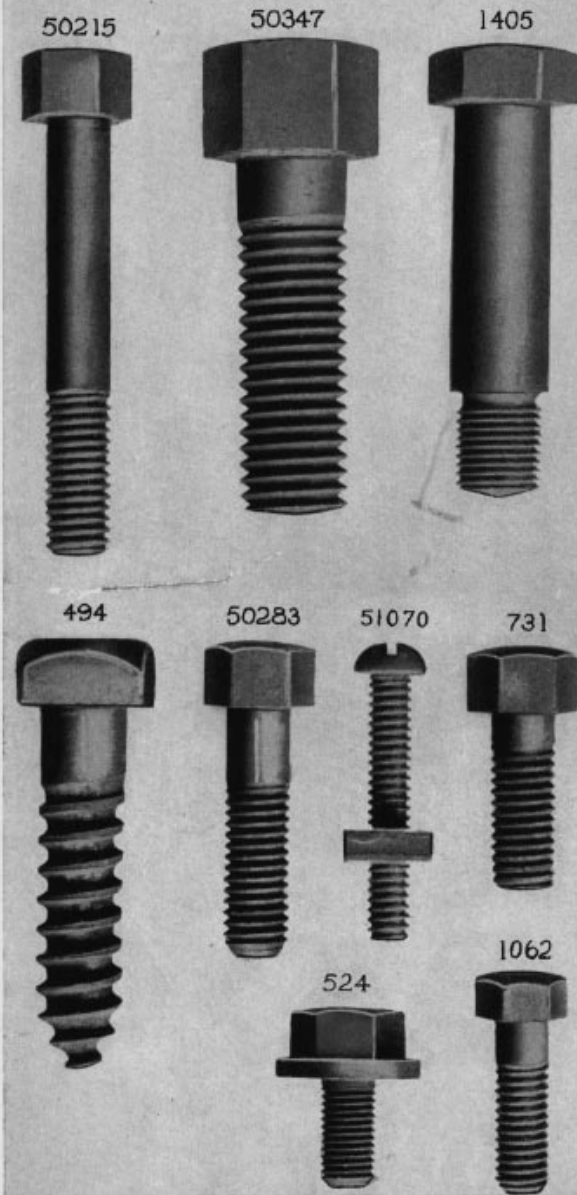




PLATE 3841—FULL SIZE

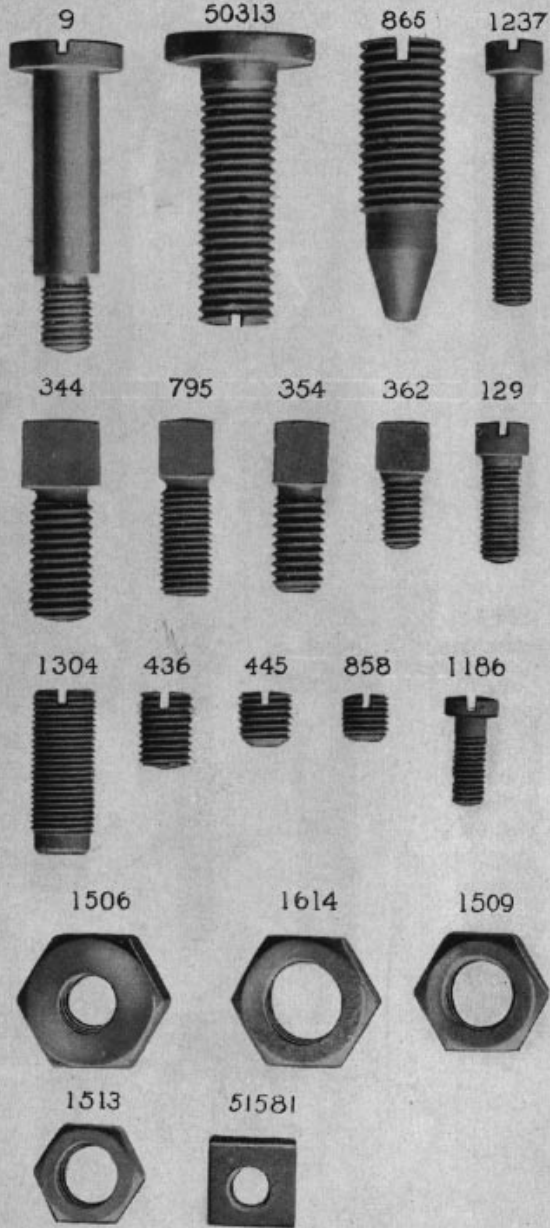


PLATE 7877—ONE-FOURTH SIZE

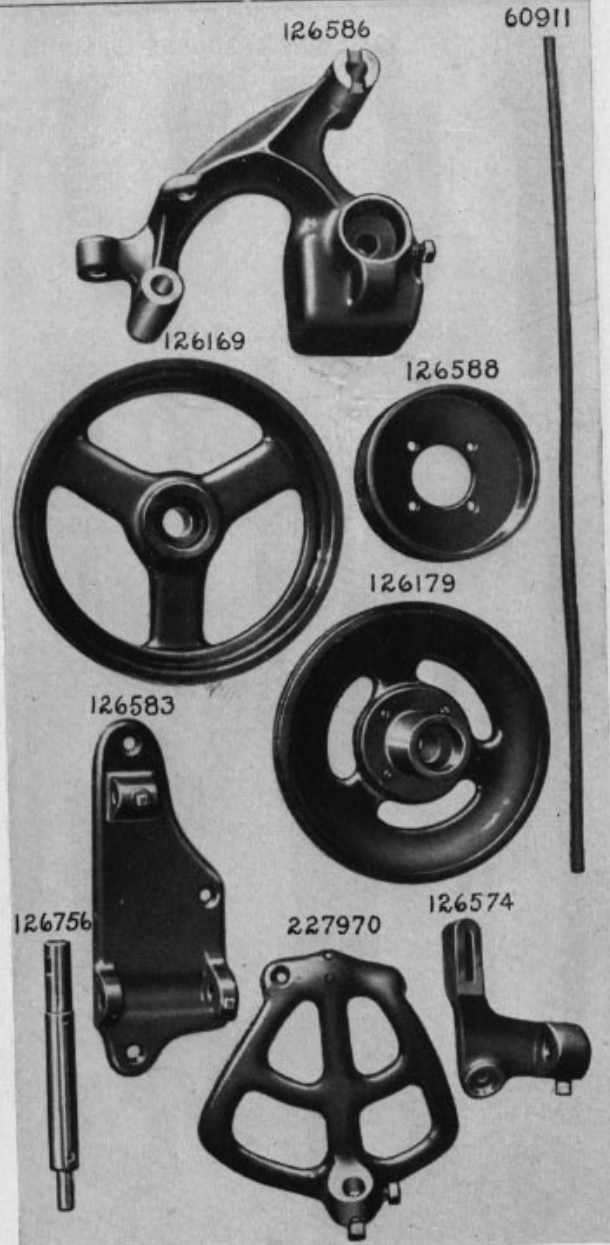


PLATE 7978—FULL SIZE

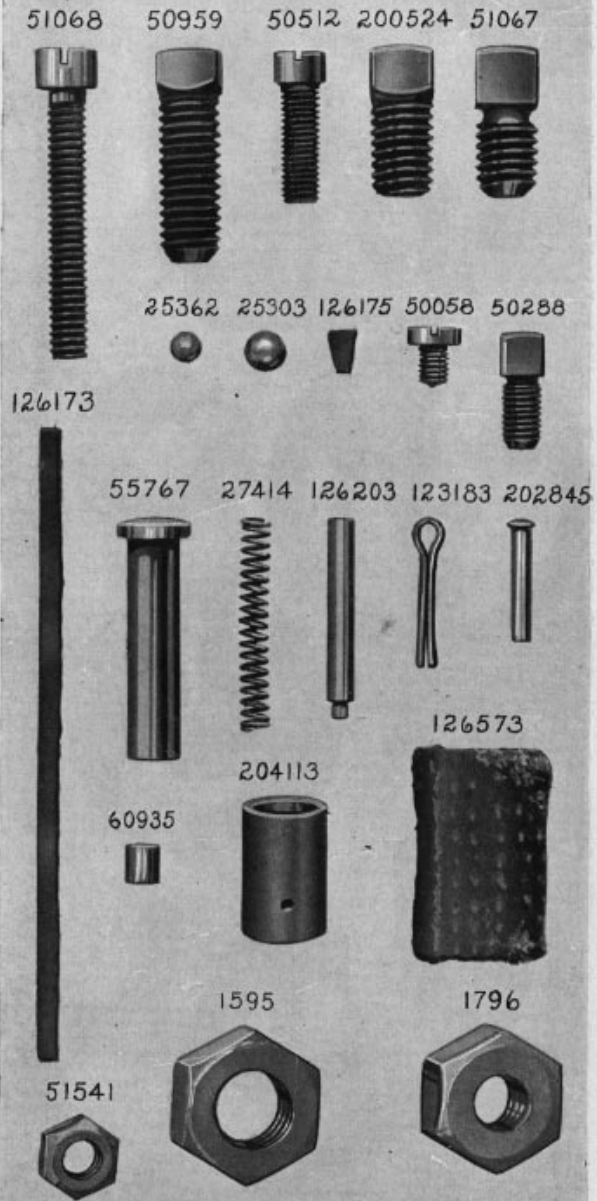


PLATE 7979—FULL SIZE

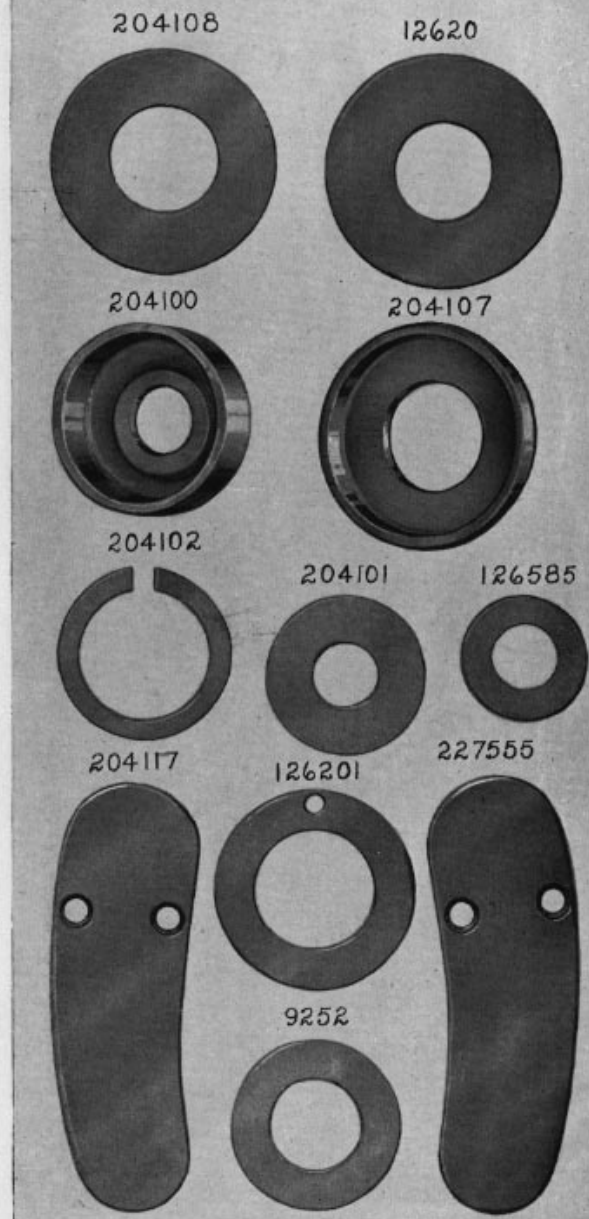


PLATE 7980—ONE-HALF SIZE

126572 126584 126575 126578

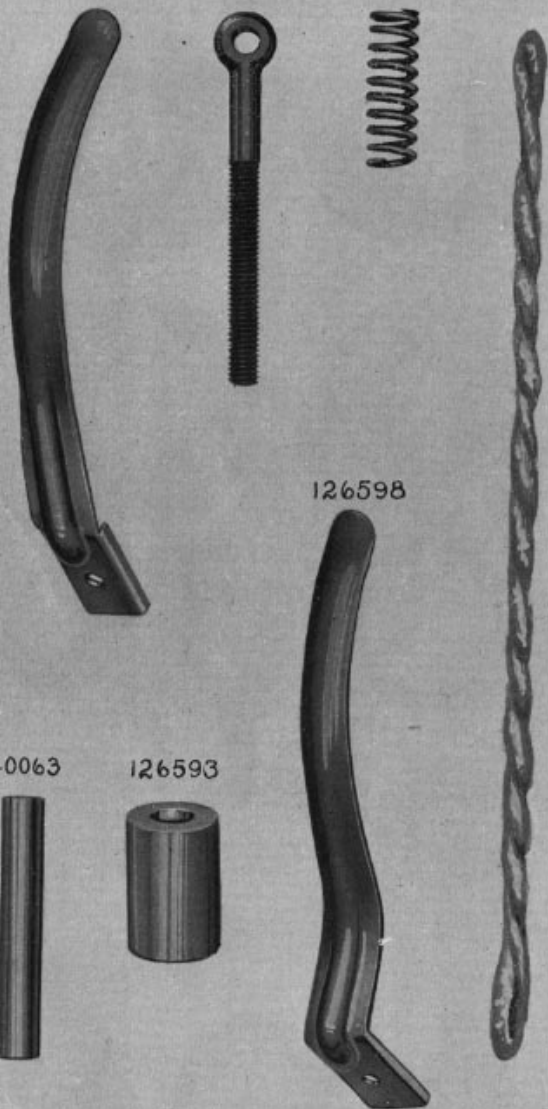
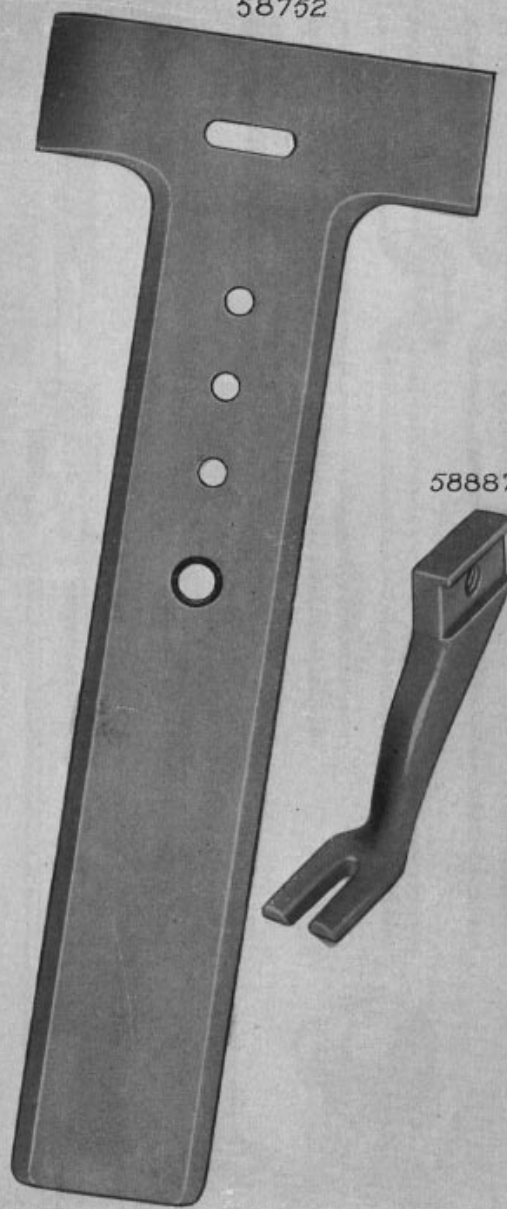


PLATE 8206—FULL SIZE

58752



58887

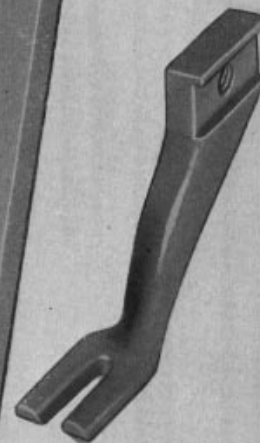


PLATE 9251—ONE-FOURTH SIZE

58954 58705 58720 58710 58734 58902

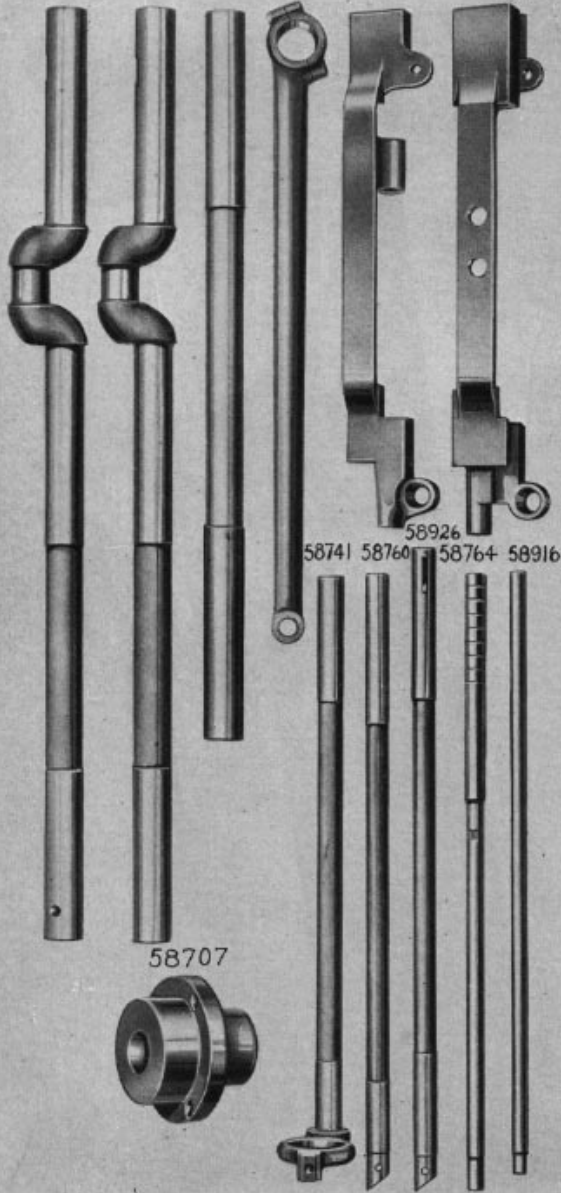


PLATE 9252—ONE-FOURTH SIZE

58712

58897

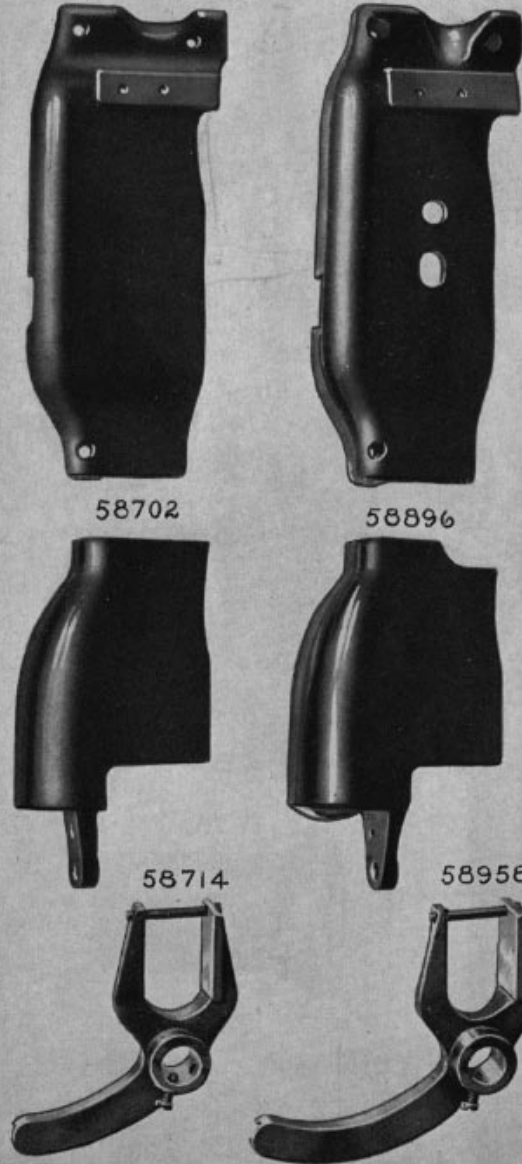




PLATE 9253—ONE-HALF SIZE

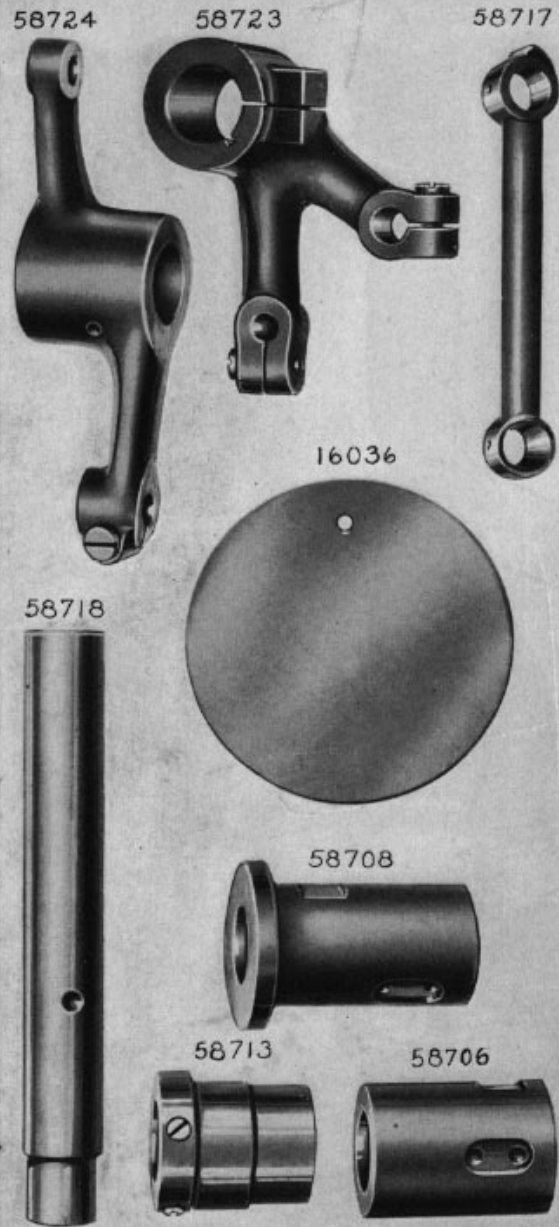


PLATE 9254—FULL SIZE

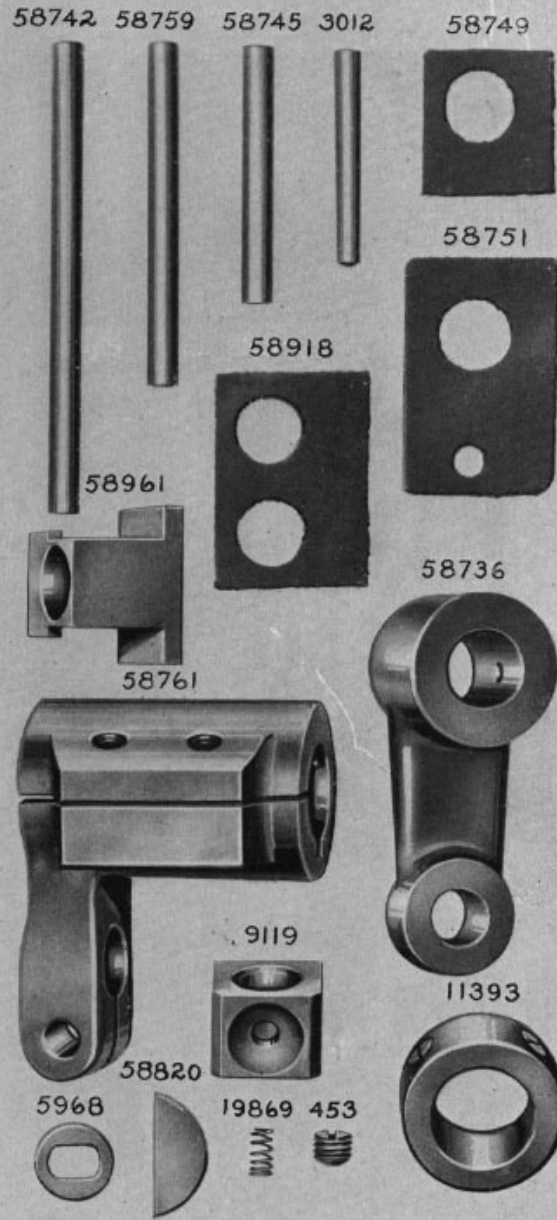
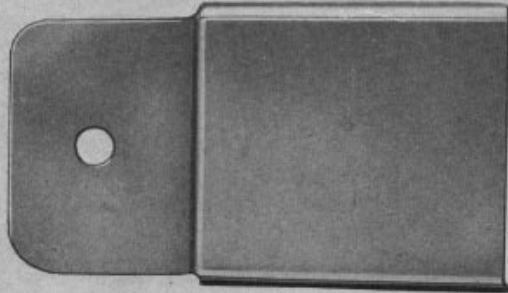


PLATE 9255—FULL SIZE

58866



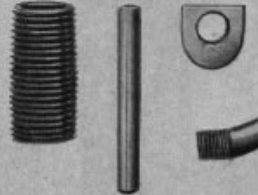
58852 58849 58859 58848 58858



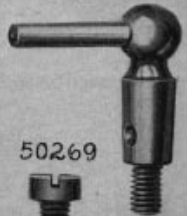
58856 58861



58862 58864 58730



58863



2117 58903 58739 50269



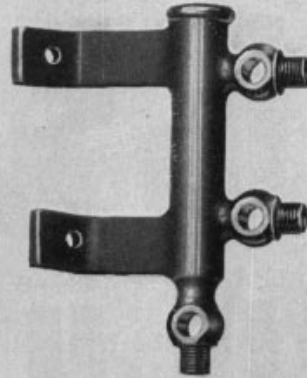
58737



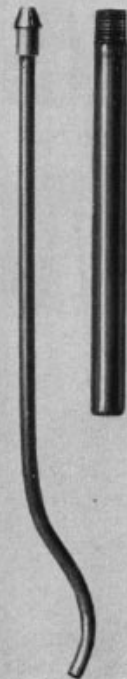
PLATE 9256—ONE-HALF SIZE

58857

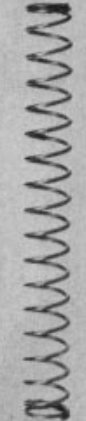
58854



58855 58860



58920



58867

58898



PLATE 9257—ONE-HALF SIZE

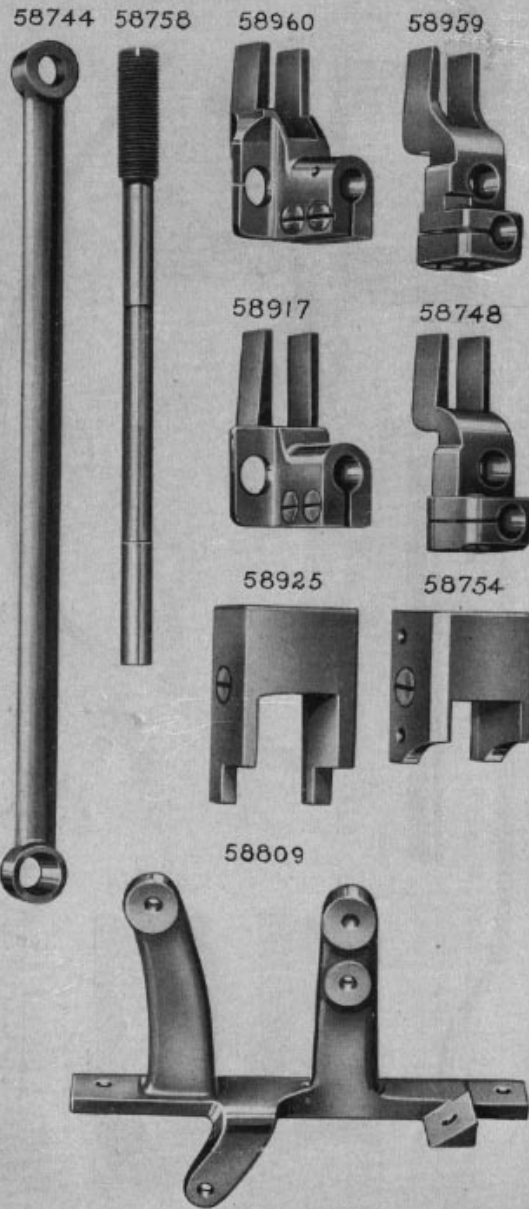


PLATE 9258—ONE-HALF SIZE

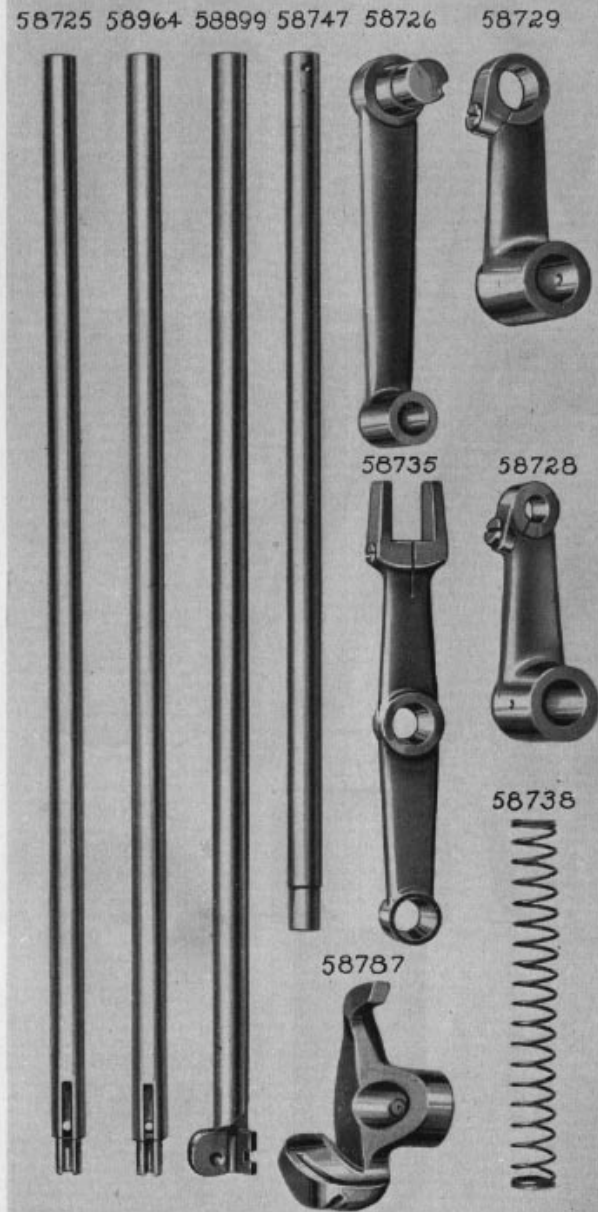


PLATE 9259—FULL SIZE

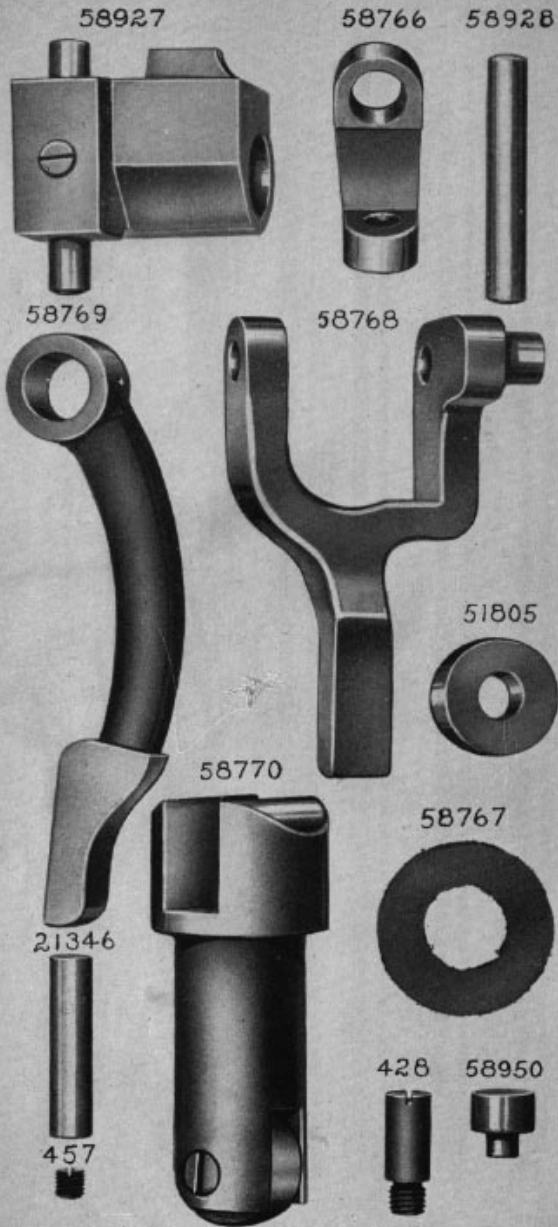


PLATE 9260—FULL SIZE

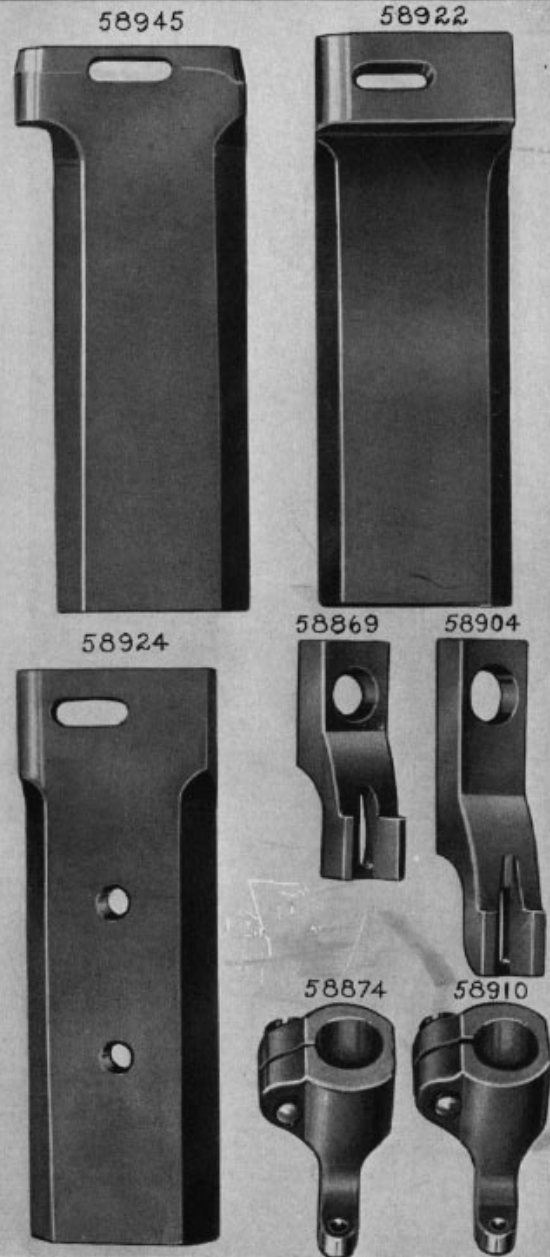
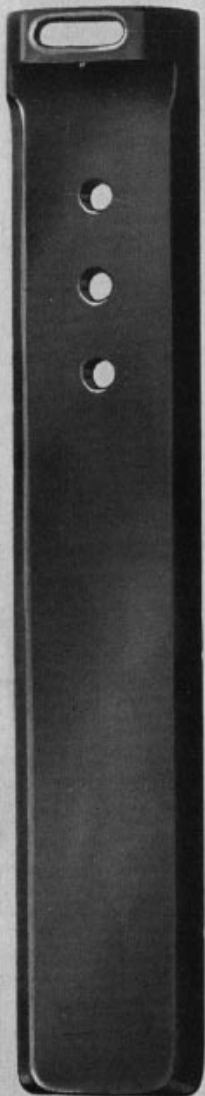


PLATE 9261—FULL SIZE

58923



58892

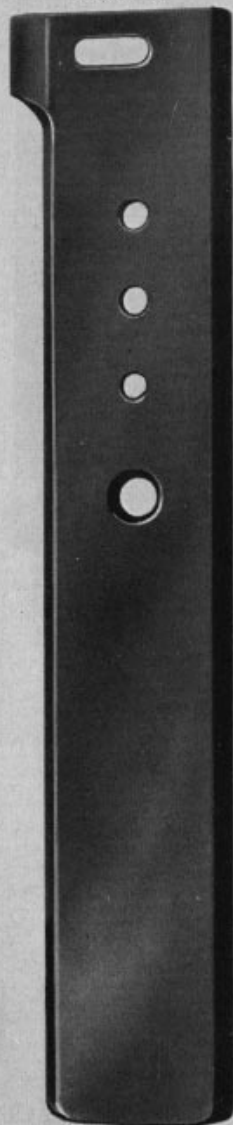


PLATE 9262—FULL SIZE

36221



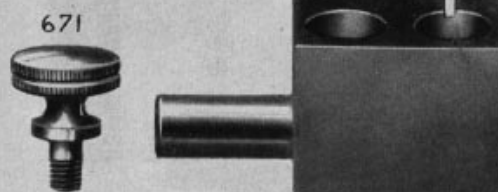
36891



120104

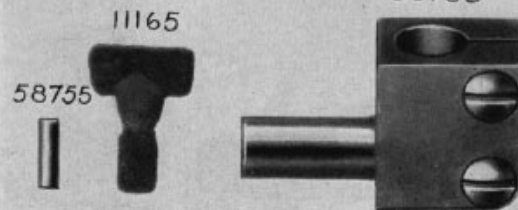


58901



671

58733



58755

11165

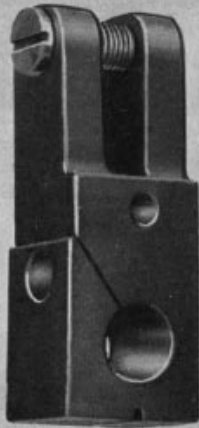


PLATE 9263—FULL SIZE

58773



58772



58948



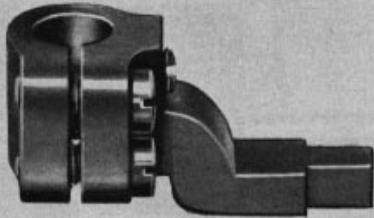
58949



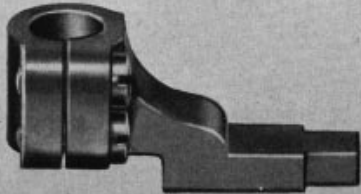
58777



58836



58776



58778



PLATE 9264—FULL SIZE

58952



58879



58957



58963



58889



58880



58780

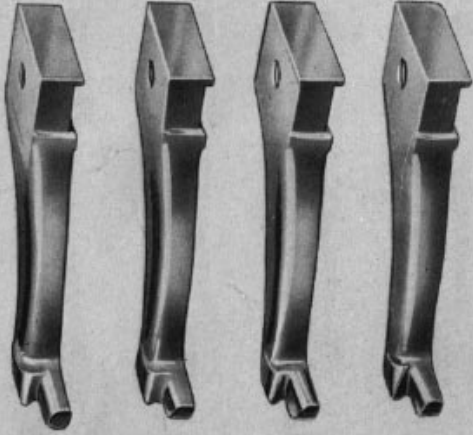


58881



PLATE 9265—FULL SIZE

58882 58883 58884 58885



58930 58946 58931 58929

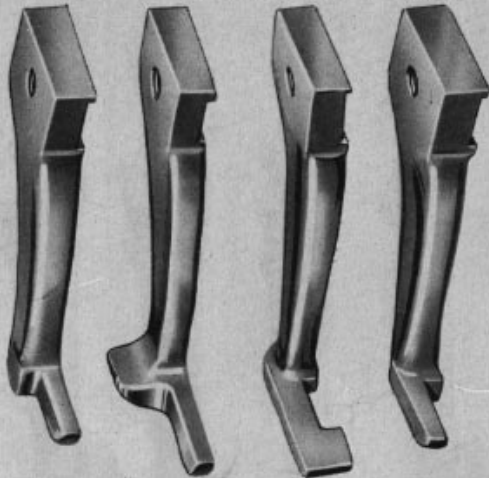


PLATE 9266—FULL SIZE

58781



58932



11910



58782



8961 58979 58783



58785 2049 58792



58793



58790



55612



58936



21788



50456



50270

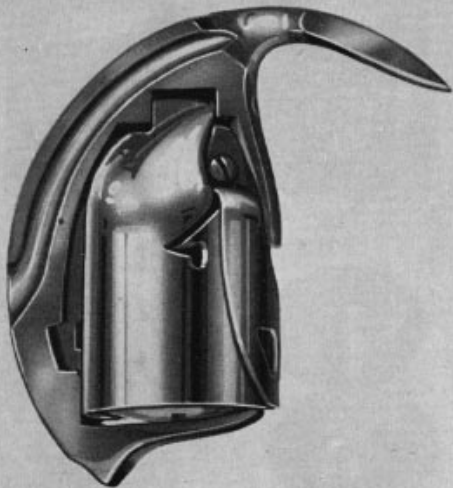


58947 12002



PLATE 9267—FULL SIZE

58786

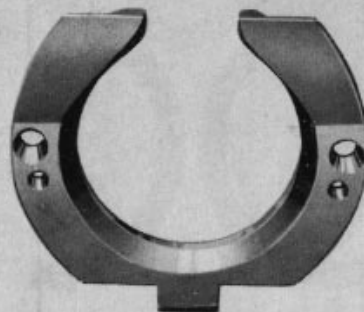


58784

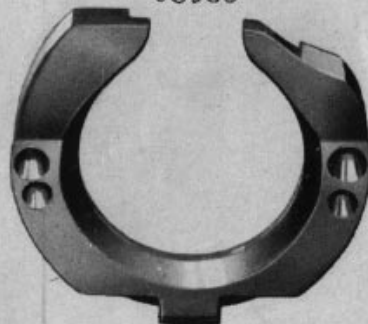


PLATE 9268—ONE-HALF SIZE

58788



58933



58934

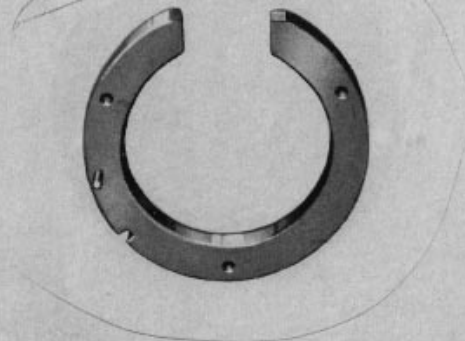




PLATE 9269—ONE-HALF SIZE

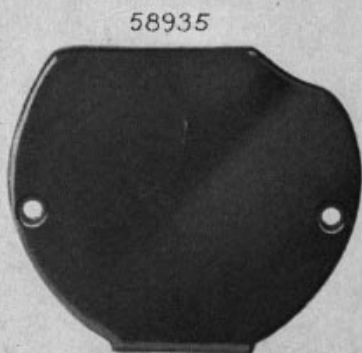
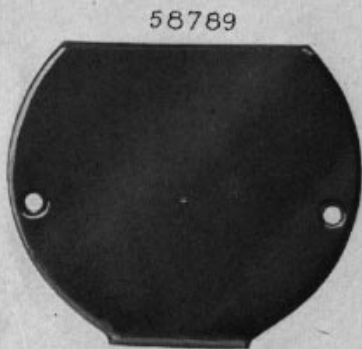
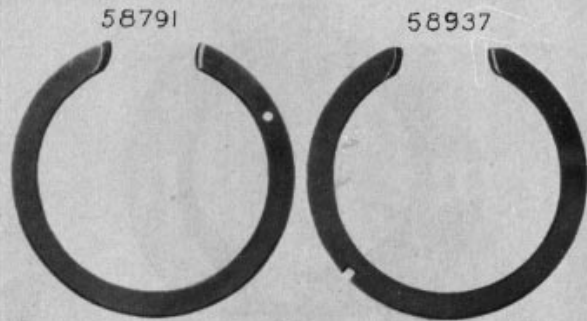
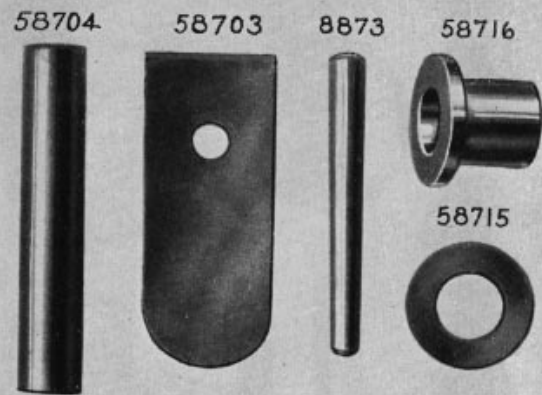


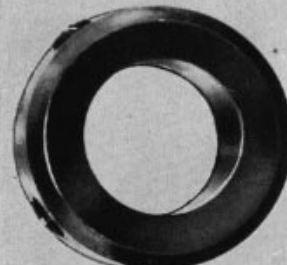
PLATE 9270—FULL SIZE



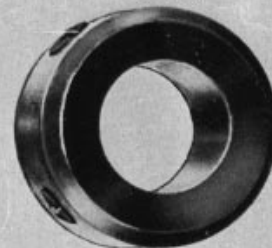
58715



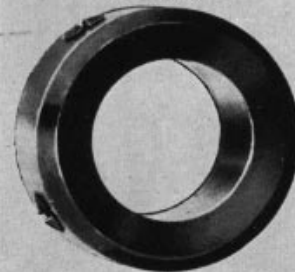
58721



58719



58722



58731



14129



58868



58732



858



58837



58838



PLATE 9271—FULL SIZE

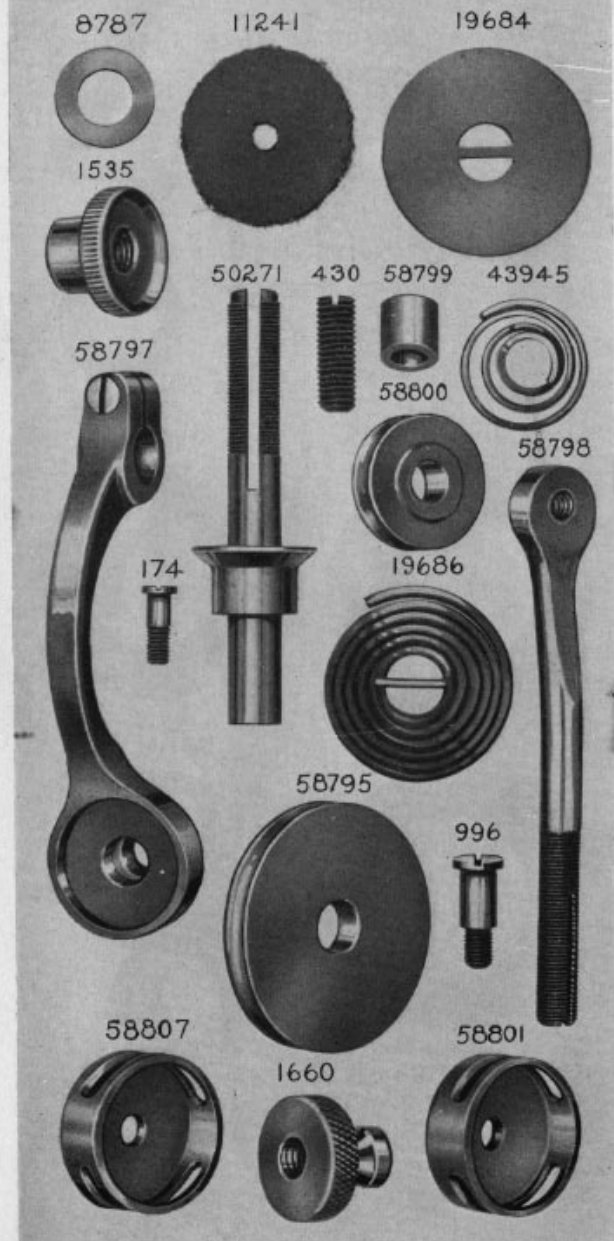


PLATE 9272—FULL SIZE

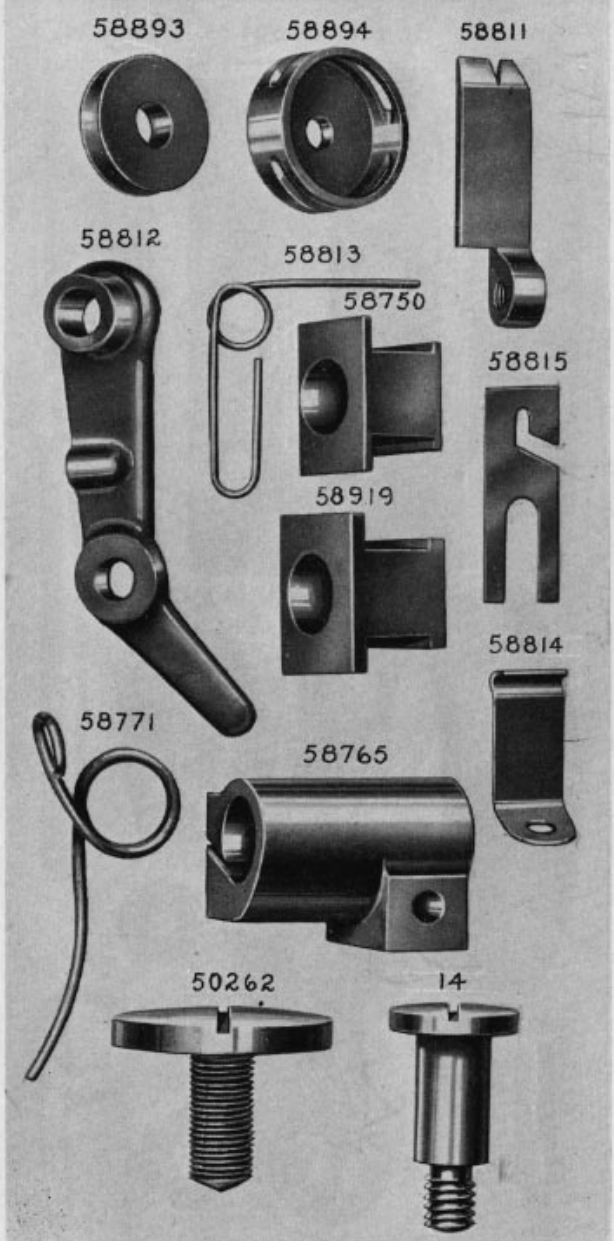


PLATE 9273—FULL SIZE

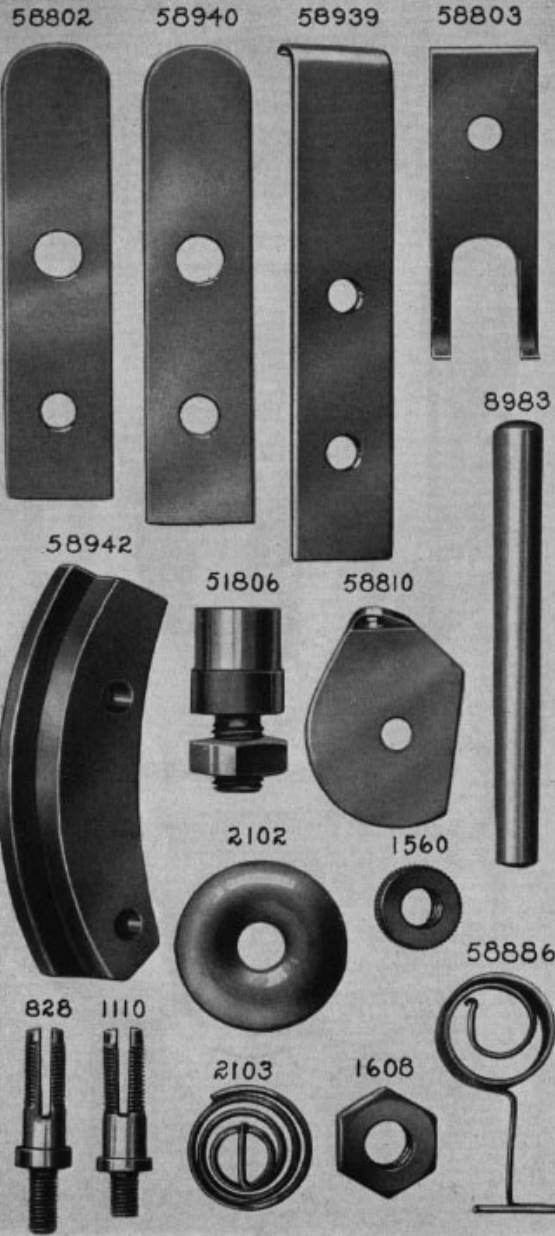


PLATE 9274—ONE-HALF SIZE

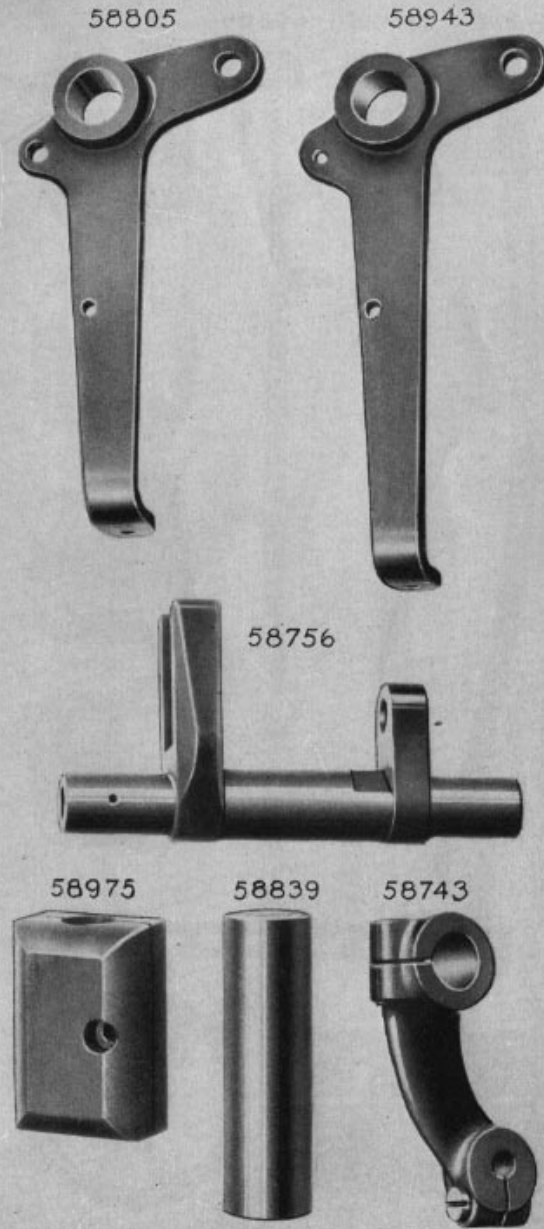


PLATE 9275—ONE-FOURTH SIZE

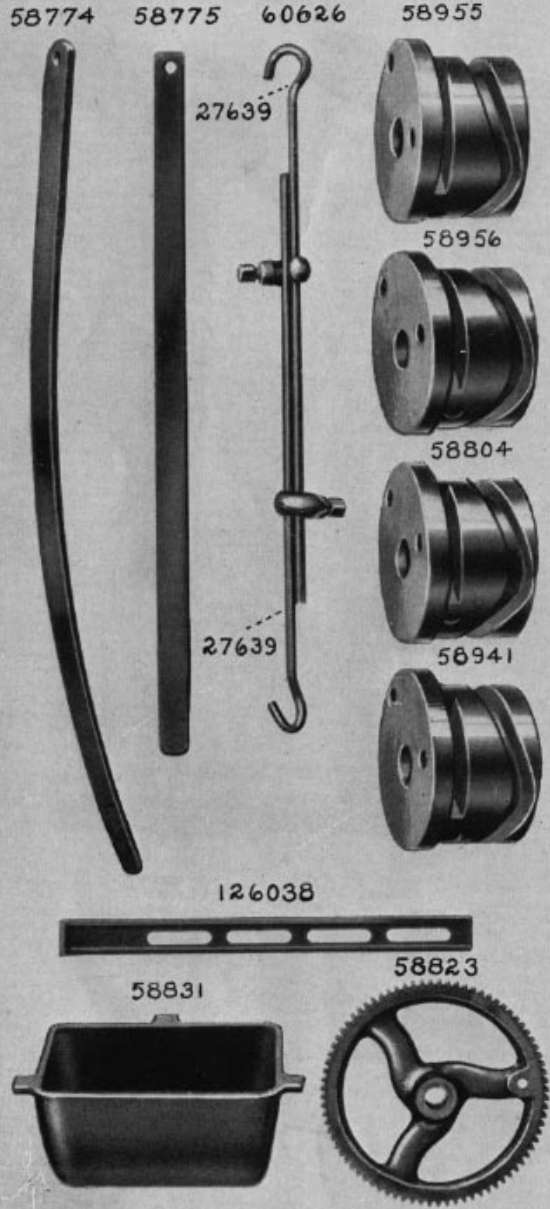


PLATE 9276—ONE-FOURTH SIZE





PLATE 9277—ONE-HALF SIZE

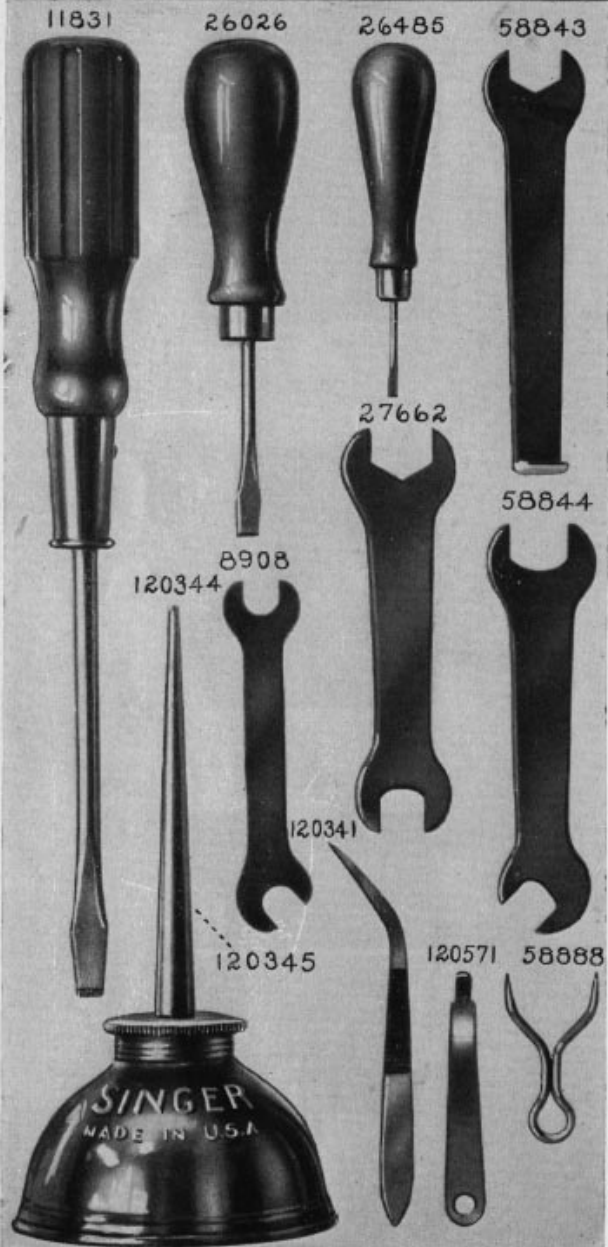


PLATE 9278—FULL SIZE

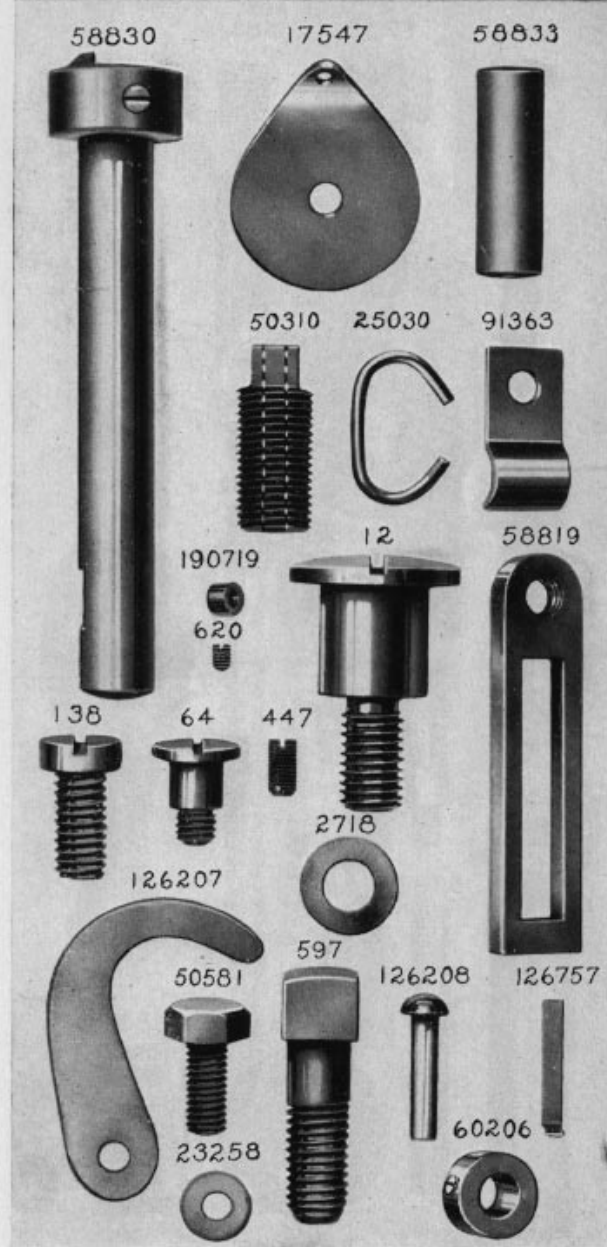


PLATE 9279—FULL SIZE

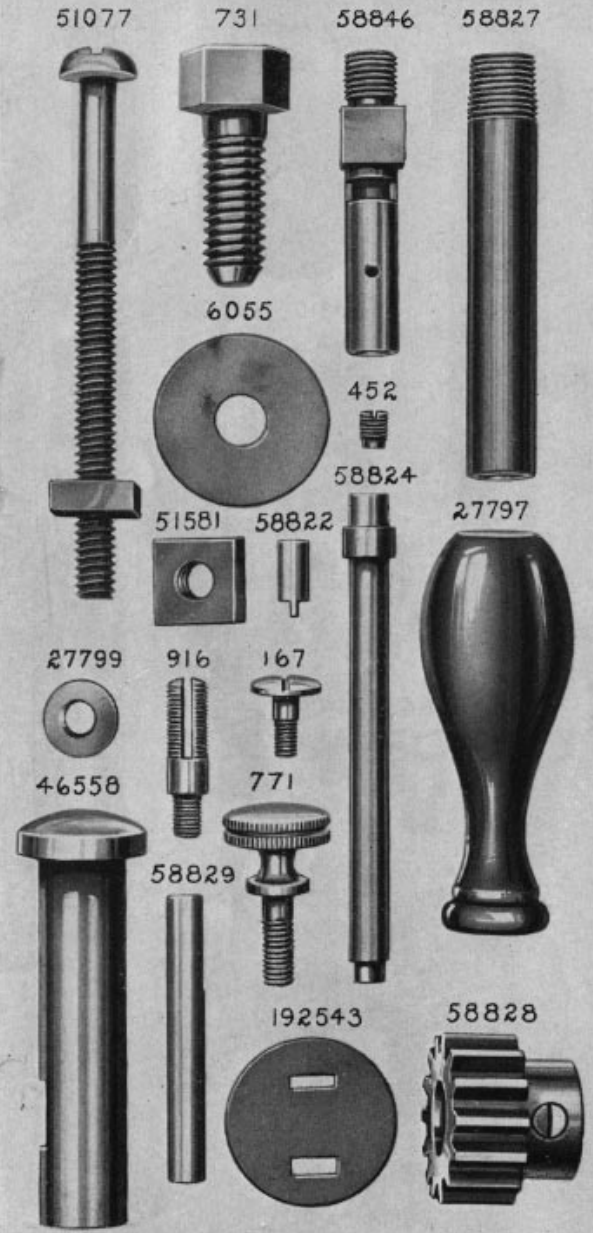
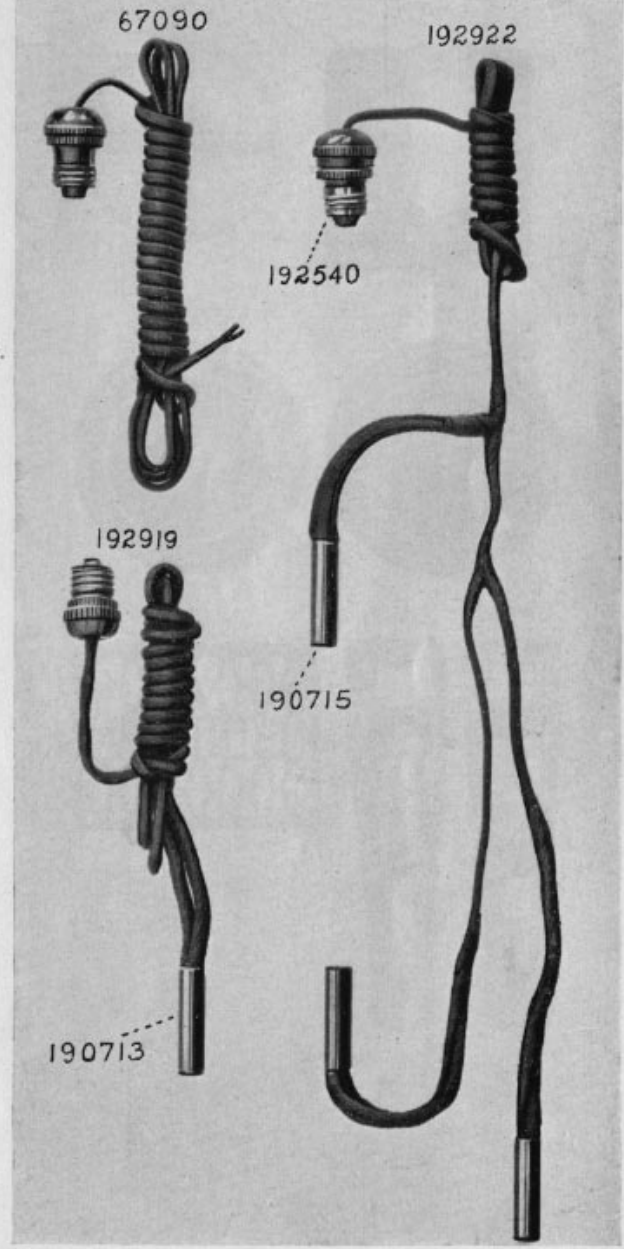
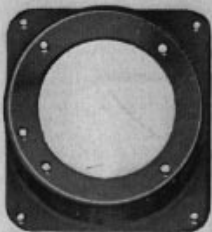


PLATE 9280—ONE-FOURTH SIZE

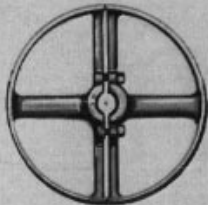


**PLATE 9281—ONE-EIGHTH SIZE**

58817



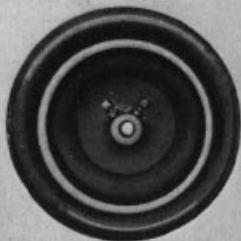
11864



58709



58845



58821



58971



126036

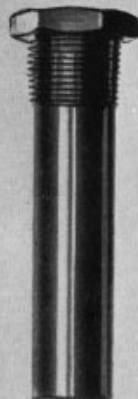


**PLATE 9282—ONE-HALF SIZE**

58835



58973



126580



60858



126205



46681



PLATE 9283—ONE-FOURTH SIZE



PLATE 9284—FULL SIZE

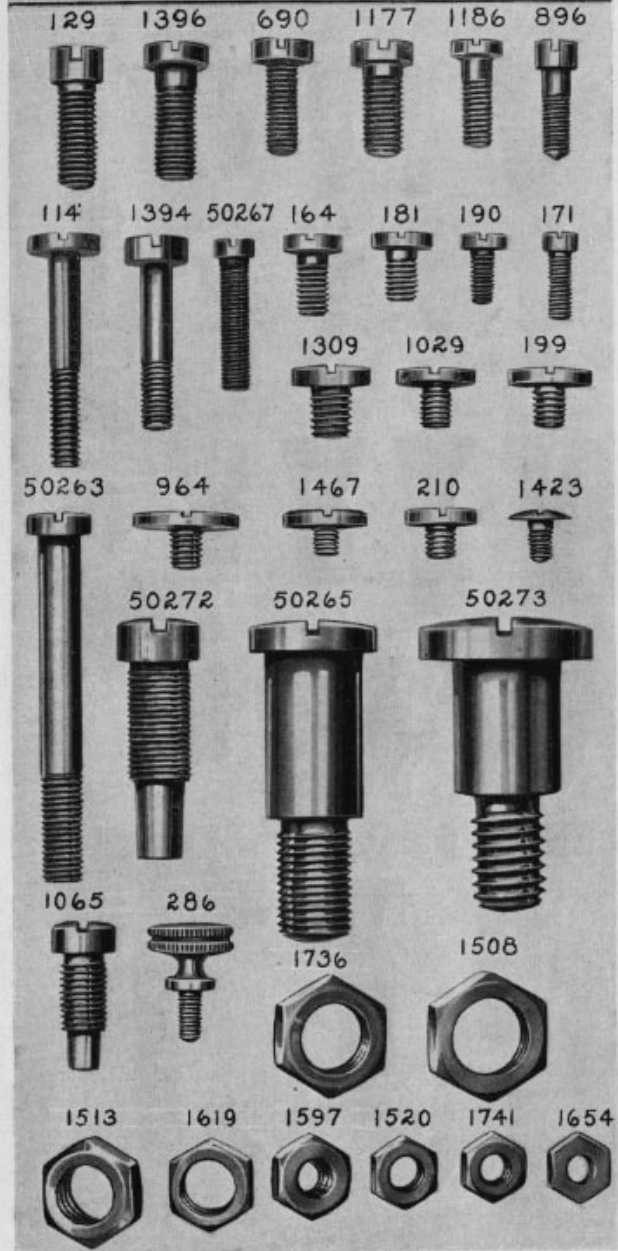




PLATE 9285—FULL SIZE



PLATE 9286—ONE-SIXTH SIZE

