

Form 20926  
(957)  
Printed in U.S.A.

HISTORICAL COPY

DO NOT REMOVE

**LIST**  
OF  
**PARTS**  
FOR FAMILY SHOPS



**SINGER**<sup>\*\*</sup>

**MACHINE No. 99-31**

---

**THE SINGER MANUFACTURING COMPANY**

\*\* A Trademark of THE SINGER MANUFACTURING COMPANY

PROPERTY OF  
THE SINGER MANUFACTURING COMPANY

This is a private and confidential communication to and for the use of only the employees of The Singer Manufacturing Company and its affiliated companies. Reproduction, sale, distribution, or publication thereof to the public is forbidden.

INDEX

	Page
Attachment Set.....	13
Bobbin Winder .....	14
Bias Gauge .....	14
Binder .....	14
Braider.....	15
Controller .....	18
Feed Cover Plate .....	15
Finger Guard .....	15
Hemmer (Feet) .....	15
Hemmer (adjustable).....	15
Hemstitcher .....	15
Machine No. 99-31 .....	7
Motor Parts.....	17
Numerical List of Parts.....	21
Presser Feet .....	16
Quilter.....	16
Ruffler.....	16
Ruffler Shirring Plate.....	16
Special Attachments .....	13
Stiletto.....	17
Spotlight.....	18
Under Braider .....	17

## INSTRUCTIONS FOR ORDERING

In ordering from this list, use ONLY the part NUMBER in the FIRST column.

The number stamped on a Sewing Machine Part is in every case the number of the single part only.

Every combination of parts sent out as such has its specific number, which, although not stamped on the parts, must be used when ordering the combination.

Each number always indicates the SAME PART in whatever list it appears, or for whatever machine.

The letters after some of the numbers indicate the style of finish only, as follows:

- A—Hardened, Polished, Nickel Plated and Buffed
- B—Polished, Nickel Plated and Buffed
- C—Hardened Only
- D—Polished Only
- E—Soft, Not Polished
- F—Hardened and Polished
- G—Bright Rumbled and Nickel Plated
- H—Blued
- J—Nickel Plated Only
- K—Hardened and Nickel Plated
- L—Brass Plated
- M—Oxidized
- R—Phosphate Coating Formed on Surface of Iron or Steel
- S—Chromium Plated
- T—Copper Plated
- U—Zinc Plated
- V—Silver Plated
- W—Polished and Nickel Plated
- X—Black Oxide for Iron and Steel
- Y—Black Nickel Plated Only
- Z—Chromium Plated
- A.A—Buffed and Chromium Plated
- A.B—Hardened, Polished, Buffed and Chromium Plated
- A.E—Hardened, Bright Rumbled and Nickel Plated
- A.F—Hardened, Bright Rumbled, Nickel Plated, Bright Rumbled and Chromium Plated
- A.G—Alumilite (Plain)
- A.H—Alumilite (Dyed) Color Must be Stated
- A.J—Polished, Nickel Plated and Chromium Plated
- A.K—Hardened, Polished, Nickel Plated and Chromium Plated
- A.L—Heat Treated for Toughness
- A.L.D—Heat Treated for Toughness and Polished
- A.L.X—Heat Treated for Toughness and Black Oxide

## INSTRUCTIONS FOR ORDERING

- A.S—Black Moulded Phenolic
- A.T—Beige Moulded Phenolic
- A.U—Brown Moulded Phenolic
- A.W—Hardened then Flame Coated with Tungsten Carbide
- B.A—Chrome Nickel Satin Finish
- B.B—Hardened and Chrome Nickel, Satin Finished
- C.R—Hardened and Phosphate Coating Formed on Surface of Steel
- F.J—Hardened, Polished and Nickel Plated
- T.A—Hardened, Polished, Copper and Nickel Plated and Buffed
- T.B—Copper and Nickel Plated and Polished
- T.J—Copper and Nickel Plated Only
- T.K—Hardened, Copper and Nickel Plated
- T.L—Copper and Brass Plated
- T.M—Copper Plated and Oxidized
- X.C—Hardened and Black Oxide for Iron and Steel
- Z.A—Hardened, Polished Nickel Plated, Buffed and Chromium Plated
- Z.B—Polished, Nickel Plated, Buffed and Chromium Plated
- Z.C—Hardened and Chromium Plated
- Z.D—Polished and Chromium Plated
- Z.G—Bright Rumbled, Nickel Plated, Bright Rumbled and Chromium Plated
- Z.J—Nickel and Chromium Plated
- Z.T—Copper and Chromium Plated

These letters MUST BE USED when they appear in the list; and AFTER the number as in the list.

In this series:

1 to 1500, 50001 to 51500 and 140001 to 142,000 are screw numbers  
1501 to 1800 and 51500 to 51800 are nut numbers  
1801 to 2000 and 51801 to 52000 are roller numbers  
2001 to 50000 and 52001 to 140000 and 142001 to 190000 are Sewing Machine Parts, 190001 and upward are numbers of Electrical Parts.

The figures in the second column refer only to the plates, illustrating the parts, and are NOT TO BE USED in ordering.

Parts marked with an asterisk (\*) are furnished only when repairs are made at the factory.

LIST OF PARTS COMPLETE  
FOR

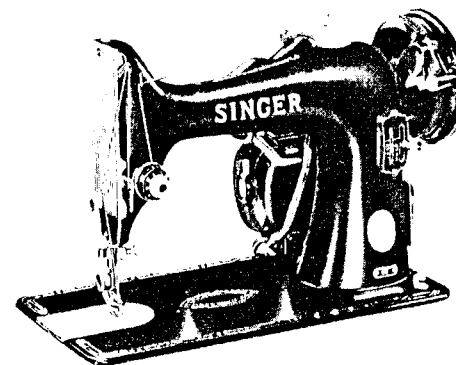

MACHINE NO. 99-31

No.	Plate	Name
*33692	-----	Arm with 448ZA and four 140543L .....
2002	26202	Arm Dowel Pin (2).....
33602R	26200	Arm Rock Shaft with 140519E .....
33661	-----	Arm Rock Shaft 33602R with 1216C and 1520R.
140519E	26200	Arm Rock Shaft Adjusting Screw .....
50046C	26200	Arm Rock Shaft Screw Center (lower).....
33666	-----	Arm Rock Shaft Screw Center (lower) 50046C with 1512R .....
1512R	26200	Arm Rock Shaft Screw Center (lower) Nut .....
50047C	26200	Arm Rock Shaft Screw Center (upper).....
138E	26202	Arm Screw (3) .....
33603	26200	Arm Shaft .....
33662	-----	Arm Shaft 33603 with 32503 and 33615 .....
32503	26200	Arm Shaft Bushing.....
448ZA	26200	Arm Shaft Bushing Set Screw .....
2007ZG	26205	Arm Spool Pin.....
8879	26205	Arm Spool Pin Washer (cloth).....
		NOTE: When ordering No. 8879, color required must be stated.
*33681P	-----	Bed .....
256ZB	26200	Clamp Stop Motion Clamp Screw .....
248ZA	26200	Clamp Stop Motion Clamp Stop Screw.....
171502	26200	Clamp Stop Motion Clamp Washer .....
32618	26200	Clamp Stop Motion Flanged Bushing.....

No.	Plate	Name
1148AL	26200	Clamp Stop Motion Flanged Bushing Set Screw
33663ZB	26201	Face Plate .....
33654ZB	26201	Face Plate 33663ZB with 125423ZB .....
203ZB	26201	Face Plate Screw .....
50684ZB	26201	Face Plate Thumb Screw.....
125422ZG	-----	Face Plate Thread Guard .....
125423ZG	26201	Face Plate Thread Guard 125422ZG with 125424ZG.....
125424ZG	-----	Face Plate Thread Guard Rivet.....
32507R	26202	Feed Bar with 1944 .....
1944	26202	Feed Bar Roller and Stud .....
315C	26202	Feed Bar Screw Center (2) .....
15455	-----	Feed Bar Screw Center 315C with 1519R (2).
1519R	26202	Feed Bar Screw Center Nut (2) .....
32600	26201	Feed Dog .....
191C	26201	Feed Dog Screw .....
33609R	26200	Feed Forked Connection .....
33664	-----	Feed Forked Connection 33609R with 1832..
1381C	26200	Feed Forked Connection Hinge Screw (eccentric)
1520R	26200	Feed Forked Connection Hinge Screw Nut...
1832	26200	Feed Forked Connection Roller with 1085E..
1085E	26200	Feed Forked Connection Roller Screw Stud..
32510R	26202	Feed Raising Bar with 1944 .....
1301C	26202	Feed Raising Bar Hinge Screw .....
1944	26202	Feed Raising Bar Roller and Stud .....
33693	26200	Feed Regulator .....
8217	26200	Feed Regulator Friction Washer.....
51771ZG	26200	Feed Regulator Thumb Nut.....
33694	-----	Feed Regulator Thumb Nut 51771ZG with 33695 and 33701 .....
33695	26200	Feed Regulator Thumb Nut Screw Stud.....
33701	26200	Feed Regulator Thumb Nut Screw Stud Friction Spring .....
51295C	26200	Feed Regulator Hinge Screw .....
33611R	26202	Feed Rock Shaft .....
307C	26202	Feed Rock Shaft Screw Center (2) .....
56814	-----	Feed Rock Shaft Screw Center 307C with 1513R (2) .....
1513R	26202	Feed Rock Shaft Screw Center Nut (2).....
32672	26200	Hand Wheel, 3/4 in. pulley .....
		NOTE: When ordering No. 32672, color required must be stated.
51045AL	26200	Machine Hinge Connection Set Screw (2).....
33655	26204	Needle Bar .....
33613	26204	Needle Bar Connecting Link .....
33678	-----	Needle Bar Connecting Link 33613 with 33673.
33673	26204	Needle Bar Connecting Stud with 1353AL .....

No.	Plate	Name
1353AL	26204	Needle Bar Connecting Stud Set Screw .....
33615	26200	Needle Bar Crank with 1036AL and 1134AL..
1134AL	26200	Needle Bar Crank Position Screw.....
33657ZB	26204	Needle Bar Hole Plug .....
2054ZG	26204	Needle Clamp with 140545ZC.....
140545ZC	26204	Needle Clamp Thumb Screw .....
32520	26203	Oscillating Hook .....
32626	-----	Oscillating Hook 32520 with 32590.....
32776R	26202	Oscillating Hook Bell Crank .....
50561C	26202	Oscillating Hook Bell Crank Hinge Screw.....
32522	26203	Oscillating Hook Bobbin .....
32590	26203	Oscillating Hook Bobbin Case with 1172F, 1173D and 32567 .....
32661	26203	Oscillating Hook Bobbin Case Cushion Spring
662J	26203	Oscillating Hook Bobbin Case Cushion Spring Screw .....
32659	26203	Oscillating Hook Bobbin Case Position Bracket.....
32660	26203	Oscillating Hook Bobbin Case Position Bracket complete, Nos. 662J, 32528, 32598, 32597, 32057, 32001, 32009, 32007, 32007 and 50580E .....
32662	26203	Oscillating Hook Bobbin Case Position Bracket Hinge Stud .....
50611J	26203	Oscillating Hook Bobbin Case Position Bracket Hinge Stud Set Screw .....
32663	26203	Oscillating Hook Bobbin Case Position Bracket Latch .....
50579J	26203	Oscillating Hook Bobbin Case Position Bracket Latch Screw .....
32598	26203	Oscillating Hook Bobbin Case Position Oil Pad (felt).....
32599	26203	Oscillating Hook Bobbin Case Position Bracket Oil Pad Holder .....
1172F	26203	Oscillating Hook Bobbin Case Tension Regu- lating Screw .....
32567	26203	Oscillating Hook Bobbin Case Tension Spring.
1173D	26203	Oscillating Hook Bobbin Case Tension Spring Screw .....
32664	26203	Oscillating Hook Bobbin Ejector.....
50580E	26203	Oscillating Hook Bobbin Ejector Hinge Screw Stud .....
32528	26203	Oscillating Hook Bobbin Ejector Spring.....
32529R	26203	Oscillating Hook Connecting Link.....
1132C	26203	Oscillating Hook Connecting Link Hinge Screw
32594R	26203	Oscillating Hook Crank with 1485R .....
1485R	26203	Oscillating Hook Crank Clamping Screw.....
33706	26202	Oscillating Hook Pitman .....

No.	Plate	Name
44C	26202	Oscillating Hook Pitman Screw Stud (left).....
1216C	26200	Oscillating Hook Pitman Screw Stud (right)...
216C	26200	Oscillating Hook Pitman Screw Stud (right) Cap Screw .....
1520R	26200	Oscillating Hook Pitman Screw Stud (right) Nut .....
32569ZB	26201	Oscillating Hook Slide .....
32570	26201	Oscillating Hook Slide Friction Spring .....
226J	26201	Oscillating Hook Slide Friction Spring Screw.
33709	26204	Presser Bar (hollow) .....
33620AF	26204	Presser Bar Lifter .....
33705	26204	Presser Bar Lifter Hinge Pin .....
33667E	26204	Presser Bar Lifting Bracket with 50052E .....
33669E	-----	Presser Bar Lifting Bracket 33667E with 33676 .....
33677	-----	Presser Bar Lifting Bracket 33669 with 240E, 33674 and 33675 .....
50052E	26204	Presser Bar Lifting Bracket Clamping Screw..
170067	26204	Presser Bar Spring .....
170068	-----	Presser Bar Spring 170067 with 170183.....
51224ZB	26201	Presser Foot Thumb Screw .....
50054ZB	26204	Pressure Regulating Thumb Screw .....
170183	26204	Pressure Regulating Thumb Screw Extension Pin .....
33678AF	26201	Stitch Thread Regulator .....
33698	26200	Stitch Indicator (red dot) .....
33699	26200	Stitch Indicator Plate .....
51384S	26200	Stitch Indicator Plate Screw (2) .....
33700	26200	Stitch Indicator Spring .....
2102	26205	Tension Disc (2) .....
45866	26205	Tension Indicator .....
45864	26205	Tension Indicator Flange .....
		NOTE: When ordering No. 45864, color required must be stated.
45865	26205	Tension Indicator Flange Stop Washer .....
51681 ZB	26205	Tension Regulating Thumb Nut with 45339....
45339	26205	Tension Regulating Thumb Nut Engaging Pin.
33659	26205	Tension Releasing Lever .....
33707	26205	Tension Releasing Lever Hinge Pin .....
33660	26205	Tension Releasing Lever Spring .....
32574	26205	Tension Releasing Pin .....
140167ZJ	26205	Tension Screw Stud .....
45870	-----	Tension Screw Stud 140167ZJ with 51681ZB..
50305C	26205	Tension Screw Stud Set Screw .....
45869	26205	Tension Spring .....
32757	26205	Tension (Graduated) complete, Nos. 32574, 32758, 32759, 45864, 45865, 45866, 45869, 45870 and two 2102 .....

No.	Plate	Name
26075C	26204	Thread Cutter and Holder .....
33632ZG	26204	Thread Guard (front of arm) .....
237ZJ	26204	Thread Guard (front of arm) Set Screw .....
8422ZG	26205	Thread Guard (head of arm) .....
33634	26204	Thread Take-up Crank .....
1036AL	26200	Thread Take-up Crank Set Screw .....
33635AF	26204	Thread Take-up Lever .....
33636ZG	-----	Thread Take-up Lever complete, Nos. 33635ZG, 33637 and 33638 (for Agents only).
33702ZG	-----	Thread Take-up Lever 33636 with 1130E, 33634, 33678, 50056E and 173558 .....
50056E	26204	Thread Take-up Lever Cap Screw .....
33637	26204	Thread Take-up Lever Hinge Stud .....
33638	26204	Thread Take-up Lever Link .....
173558	26204	Thread Take-up Lever Link Hinge Stud .....
33704	-----	Thread Take-up Lever Link Hinge Stud 173558 with 1130E (for Agents only) .....
1130E	26204	Thread Take-up Lever Link Hinge Stud Cap Screw .....
44741	26204	Thread Take-up Lever Link Hinge Stud Set Screw .....
32758	26205	Thread Take-up Spring .....
32759	26205	Thread Take-up Spring Regulator with 50305C
453AL	26205	Thread Take-up Spring Regulator Set Screw..
32783	26201	Throat Plate .....
691BB	26201	Throat Plate Screw (2) .....
33674	26204	Timing Gauge, for setting the height of the Needle Bar and timing the Oscillating Hook ..
240E	26204	Timing Gauge Screw .....
33675J	26204	Timing Gauge Screw Washer .....
140543L	-----	Trade Mark Drive Screw (2) .....
140543L	-----	Number Plate Drive Screw (2) .....

## ATTACHMENT SET

No.	Plate	Name
25527	26207	Seam Guide .....
32522	26207	Bobbin (4) .....
32622	26207	Feed Cover Plate (Flat Top) .....
50053ZB	26207	Seam Guide Thumb Screw .....
120378	26207	Screw Driver .....
161127	26207	Presser Foot (adjustable, for sewing either on the right or left side of the needle) complete for cording and slide fasteners.....
161133	26207	Tube of Oil .....
161208	26207	Box (plastic).....
15 x 1	-----	Needles three each of sizes 11 and 14 (6)...
161119	26207	Attachment Set, packaged in Box (plastic) No. 161208, Nos. 25527, 32622, 50053ZB, 120378, 161127, 161133, four 32522 and six needles (15x1, three each of sizes Nos. 11 and 14) for U.S.A. and Canada only.

## SPECIAL ATTACHMENTS

No.	Plate	Name
160506	-----	Buttonholer .....
35505	-----	Embroidery Attachment for two threads.....
26538	-----	Style-O-Matic Attachment .....
121634	-----	Needle Threader and Seam Ripper.....
35985	-----	Tubular Trimming Attachment .....
160720	-----	Darning and Embroidery Attachment .....
160741	-----	Walking Presser Foot .....

**BOBBIN WINDER (Universal)**

No.	Plate	Name
15072	26206	Bobbin Position Pin .....
33689	26206	Bracket (belt cover) .....
180ZB	26206	Bracket Screw .....
66670	26206	Frame .....
45297	26206	Frame 66670 with 15288ZG and 66671ZG.....
51319R	26206	Frame Hinge Screw .....
66601	26206	Frame Spring .....
15287	26206	Friction Ring (rubber).....
NOTE: When ordering No. 15287, color required must be stated.		
15288ZG	26206	Pulley .....
66671ZG	26206	Spindle with 15072 .....
45268ZG	26206	Stop Latch .....
51303X	26206	Stop Latch Hinge Screw.....
66775	26206	Stop Latch Spring .....
125326	26206	Tripping Arm .....
190ZJ	26206	Tripping Arm Screw .....
33691	26206	Thread Guide .....
208ZJ	26206	Thread Guide Screw .....

**BIAS GAUGE**

No.	Plate	Name
25525	26209	Bias Gauge .....

**BINDER**

No.	Plate	Name
160359	26209	Binder .....

**BRAIDER**

No.	Plate	Name
25510	26208	Braider .....
289B	26208	Braider Thumb Screw.....

**FEED COVER PLATE**

No.	Plate	Name
32589	26209	Feed Cover Plate (oval top).....

**FINGER GUARD**

No.	Plate	Name
121725	26208	Finger Guard .....

**HEMMER (Feet)**

No.	Plate	Name
120842	26208	Hemmer Foot, 5/64 in. Hem .....
25893	26208	Hemmer Foot, 1/4 in. Hem .....
36333	26208	Hemmer Foot, Flanged for chiffon and Silk..

**HEMMER (Adjustable)**

No.	Plate	Name
35931	26209	Hemmer (adjustable) .....

**HEMSTITCHER**

No.	Plate	Name
120687	26209	Hemstitcher with Yielding Presser Plate .....



## PRESSER FEET

No.	Plate	Name
121441	26208	Presser Foot for Gathering .....
25978	26208	Presser Foot (single toe) for gathering .....
121614	26208	Presser Foot with 51282J and 121615, for blind stitch braiding, for soutache braid.....
121615	26208	Presser Foot Braid Guide .....
	NOTE:	When ordering Nos. 121614 or 121615, send sample of braid for which it is to be used.
51282J	26208	Presser Foot Braid Guide Screw.....
36058	26208	Presser Foot with 665B and 36059, for blind stitch cording, to turn small curves .....
36059	26208	Presser Foot Cord Guide .....
	NOTE:	When ordering Nos. 36058 or 36059, send sample of cord for which it is to be used.
665B	26208	Presser Foot Cord Guide Screw .....
36067	26208	Presser Foot for braiding, for art work, for braid 1/16 in. to 3/16 in. wide .....
	NOTE:	When ordering No. 36067, send sample of the braid for which it is to be used.

## QUILTER

No.	Plate	Name
35932	26208	Quilter .....

## RUFFLER

No.	Plate	Name
120598	26209	Ruffler, for one, six and twelve stitch Ruffling

## RUFFLER SHIRRING PLATE

No.	Plate	Name
121170	26209	Ruffler Shirring Plate with 51395W .....
51395W	26209	Ruffler Shirring Plate Thumb Screw.....

## STILETTO

No.	Plate	Name
25539	26208	Stiletto .....

## UNDER BRAIDER

No.	Plate	Name
160927	26209	Under Braider with 51395W.....
51395W	26209	Under Braider Thumb Screw .....
25637	26209	Under Braider Foot .....

## MOTOR PARTS

No.	Plate	Name
197280	-----	Armature complete for RF5-7 Motor .....
197275	20210	Armature complete for RF5-8 Motor .....
195540	26210	Armature Shaft Bearing (2).....
195541	26210	Armature Shaft Bearing Retainer (2) .....
931744	26210	Armature Shaft Thrust Washer (1/64 in.).....
931745	-----	Armature Shaft Thrust Washer (1/32 in.).....
931746	-----	Armature Shaft Thrust Washer (3/64 in.).....
198651	26210	Belt (moulded).....
192457	26210	Brush (carbon) (2).....
197293	26210	Brush Holder .....
196832	26210	Brush Holder Spacing Bushing (2).....
192458	26210	Brush Spring (2).....
197611	26210	Brush Tube Insulation (2).....
197279	26210	End Cover (commutator end).....
197278	26210	End Cover (pulley end) .....
140687	26210	End Cover Fastening Screw (2).....
1783	26210	End Cover Fastening Screw Nut (4).....
197282	-----	Field Coils complete for RF5-7 Motor .....
197277	-----	Field Coils complete for RF5-8 Motor .....
964514	26210	Field Coils Retainer (2).....
195871	-----	Field Core complete for RF5-7 and RF5-8 Motors .....
197281	-----	Field Core with Coils and Terminals complete for RF5-7 Motor .....
197276	26210	Field Core with Coils and Terminals complete for RF5-8 Motor .....
196903	26211	Lead Cord Complete.....
197613	26211	Lead Cord Plug .....
888043	26210	Lead Connector (large) (2).....

## MOTOR PARTS

No.	Plate	Name
887915	26210	Lead Connector (small) .....
197612	26211	Lead Strain Relief (3).....
140688	26210	Motor Screw .....
701734	26210	Motor Screw Washer.....
190087	26210	Pulley .....
190086	-----	Pulley 190087 with 1019AL.....
1019AL	26210	Pulley Set Screw.....

## CONTROLLER (Treadle)

No.	Plate	Name
196819	26211	Controller Back Cover .....
196824	26211	Controller Back Cover Cushion (4).....
1783	26211	Controller Back Cover Screw Nut .....
931055		
196826	26211	Controller Housing.....
196849	26211	Controller Insulation.....
196924	26211	Controller Lead with 196881 and 197612.....
196881	26211	Controller Lead Bushing .....
197612	26211	Controller Lead Strain Relief.....
140686	26211	Controller Resistance Unit and Back Cover Screw .....
50939	26211	Controller Resistance Unit Screw (short).....
1783	26211	Controller Resistance Unit Screw Nut (2).....
701992	26211	Controller Resistance Unit Screw Nut Washer (2)
196827	26211	Controller Resistance Unit Complete .....
196906	26211	Controller complete, Nos. 50939, 140686, 196819, 196826, 196827, 196849, 196924, 931055, two 701992, three 1783 and four 196824 .....

## SPOTLIGHT

No.	Plate	Name
195127	26212	Spotlight Body (lower half) .....
195128	26212	Spotlight Body (upper half) .....
195129	26212	Spotlight Body Snap Ring (large).....
195130	26212	Spotlight Body Snap Ring (small).....
195224	26212	Spotlight Bracket .....
51463XC	26212	Spotlight Bracket Screw .....

## SPOTLIGHT

No.	Plate	Name
195148	26212	Spotlight Lamp .....
		NOTE: When ordering No. 195148, state voltage required.
195132	26212	Spotlight Lamp Socket.....
195135	26212	Spotlight Lead with 195132.....
195133	26212	Spotlight Lens (blue glass) .....
195134	26212	Spotlight Lens Tension Spring .....
196240	26212	Spotlight Switch Key .....
195143	-----	Spotlight Switch Key Snap Ring.....
195957	26212	Spotlight Switch Rotating Contact with Cam and Insulator.....
195140	26212	Spotlight Switch Spring Contact (lamp side)..
195141	26212	Spotlight Switch Spring Contact (lead side)...
195233	26212	Spotlight (blue glass lens) complete, Nos. 177X, 51463XC, 195127, 195128, 195129, 195130, 195133, 195134, 195135, 195140, .....
		196240 and 196625 .....
177X	-----	Spotlight Screw .....
196625	-----	Spotlight Screw Retaining Washer .....

## NUMERICAL LIST OF PARTS

No.	Plate	Name
44C	26202	Oscillating Hook Pitman Screw Stud (left) ...
138E	26202	Arm Screw (3) .....
177X	-----	Spotlight Screw for 195233.....
180ZB	26206	Bobbin Winder Bracket Screw.....
190ZJ	26206	Bobbin Winder Tripping Arm Screw for 33690
191C	26201	Feed Dog Screw .....
203ZB	26201	Face Plate Screw .....
208ZJ	26206	Bobbin Winder Thread Guide Screw.....
216C	26200	Oscillating Hook Pitman Screw Stud (right) Cap Screw.....
226J	26201	Oscillating Hook Slide Friction Spring Screw
237ZJ	26204	Thread Guard (front of arm) Set Screw.....
240E	26204	Timing Gauge Screw for 33677.....
248ZA	26200	Clamp Stop Motion Clamp Stop Screw.....
256ZB	26200	Clamp Stop Motion Clamp Screw .....
289B	26208	Braider Thumb Screw .....
287C	26208	Feed Bar Hinge Screw .....
315C	26202	Feed Bar Screw Center for 15445 .....
447AL	26204	Thread Take-up Lever Link Hinge Stud Set Screw .....
448ZA	26200	Arm Shaft Bushing Set Screw for 33692.....
453AI	26205	Thread Take up Spring Regulator Set Screw ..
662J	26203	Oscillating Hook Bobbin Case Cushion Spring Screw for 32660.....
665B	26208	Presser Foot Cord Guide Screw for 36058.....
691BB	26201	Throat Plate Screw .....
1019AL	26210	Pulley Set Screw for 190086.....
1036AL	26200	Thread Take-up Crank Set Screw for 33615..
1085E	26200	Feed Forked Connection Roller Screw Stud for 1832.....
1130E	26204	Thread Take-up Lever Link Hinge Stud Cap Screw for 33702 and 33704.....
1132C	26203	Oscillating Hook Connecting Link Hinge Screw .....
1134AL	26200	Needle Bar Crank Position Screw for 33615..
1148AL	26200	Clamp Stop Motion Flanged Bushing Set Screw
1172F	26203	Oscillating Hook Bobbin Case Tension Regu- lating Screw for 32590.....
1173D	26203	Oscillating Hook Bobbin Case Tension Spring Screw for 32590 .....
1216C	26200	Oscillating Hook Pitman Screw Stud (right) for 33661.....
1301C	26202	Feed Raising Bar Hinge Screw.....
1353AL	26204	Needle Bar Connecting Stud Set Screw for 33673 .....

No.	Plate	Name
1381C	26200	Feed Forked Connection Hinge Screw (eccentric).....
1485R	26203	Oscillating Hook Crank Clamping Screw for 32594.....
1512R	26200	Arm Rock Shaft Screw Center (lower) Nut for 33666.....
1513R	26202	Feed Rock Shaft Screw Center Nut for 56814
1519R	26202	Feed Bar Screw Center Nut for 15445.....
1520R	26200	Feed Forked Connection Hinge Screw Nut....
1520R	26200	Oscillating Hook Pitman Screw Stud (right) Nut for 33661.....
1783	26210	End Cover Fastening Screw Nut.....
1783	26211	Controller Back Cover Screw Nut for 196906
1783	26211	Controller Resistance Unit Screw Nut for 196906.....
1832	26200	Feed Forked Connection Roller with 1085E, for 33664.....
1944	26202	Feed Bar Roller and Stud for 32507.....
1944	26202	Feed Raising Bar Roller and Stud for 32510.
2002	26202	Arm Dowel Pin.....
2007/LG	26205	Arm Spool Pin.....
2054ZG	26204	Needle Clamp with 140545ZC.....
2102	26205	Tension Disc for 32757.....
8217	26200	Feed Regulator Friction Washer.....
8422ZG	26205	Thread Guard (head of arm).....
8879	26205	Arm Spool Pin Washer (cloth).....
		NOTE: When ordering No. 8879, color required must be stated.
15072	26206	Bobbin Winder Bobbin Position Pin for 66671
15287	26206	Bobbin Winder Friction Ring (rubber) for 33690.....
		NOTE: When ordering No. 15287, color required must be stated.
15288ZG	26206	Bobbin Winder Pulley for 45297.....
15445	-----	Feed Bar Screw Center 315C with 1519R.....
25510	26208	Braider.....
25525	26209	Bias Gauge.....
25527	26207	Seam Guide for 161119.....
25539	26208	Stiletto.....
25637	26209	Under Braider Foot.....
25893	26208	Hemmer Foot 1/4" hem.....
25978	26208	Presser Foot (single toe) for Gathering.....
26075C	26204	Thread Cutter and Holder.....
26538	-----	Style-o-Matic Attachment (special attachments)
32503	26200	Arm Shaft Bushing for 33662.....
32507R	26202	Feed Bar with 1944.....
32510R	26202	Feed Raising Bar with 1944.....
32520	26203	Oscillating Hook for 32626.....
32522	26207	Bobbin for 161119.....

No.	Plate	Name
32522	26203	Oscillating Hook Bobbin.....
32528	26203	Oscillating Hook Bobbin Ejector Spring for 32660.....
32529R	26203	Oscillating Hook Connecting Link.....
32567	26203	Oscillating Hook Bobbin Case Tension Spring for 32590.....
32569ZB	26201	Oscillating Hook Slide.....
32570	26201	Oscillating Hook Slide Friction Spring.....
32574	26205	Tension Releasing Pin for 32757.....
32589	26209	Feed Cover Plate (oval top).....
32590	26203	Oscillating Hook Bobbin Case with 1172F, 1173D and 32567, for 32626.....
32594R	26203	Oscillating Hook Crank with 1485R.....
32598	26203	Oscillating Hook Bobbin Case Position Oil Pad (felt) for 32660.....
32599	26203	Oscillating Hook Bobbin Case Position Bracket Oil Pad Holder for 32660.....
32600	26201	Feed Dog.....
32618	26200	Clamp Stop Motion Flanged Bushing.....
32622	26207	Feed Cover Plate (flat top) for 161119.....
32626	-----	Oscillating Hook 32520 with 32590.....
32659	26203	Oscillating Hook Bobbin Case Position Bracket for 32660.....
32660	26203	Oscillating Hook Bobbin Case Position Bracket complete, Nos. 662J, 32528, 32598, 32599, 32604, 32601, 32602, 32603, 32604, 50579J and 50580E.....
32661	26203	Oscillating Hook Bobbin Case Cushion Spring for 32660.....
32662	26203	Oscillating Hook Bobbin Case Position Bracket Hinge Stud for 32660.....
32663	26203	Oscillating Hook Bobbin Case Position Bracket Latch for 32660.....
32664	26203	Oscillating Hook Bobbin Ejector for 32660....
32672	26200	Hand Wheel, 3/4 in. pulley.....
		NOTE: When ordering No. 32672, color required must be stated.
32757	26205	Tension (Graduated) complete, Nos. 32574, 32758, 32759, 45864, 45865, 45866, 45869, 45870 and two 2102.....
32758	26205	Thread Take-up Spring for 32757.....
32759	26205	Thread Take-up Spring Regulator with 50305C, for 32757.....
32773ZG	26201	Presser Foot (hinged).....
32776R	26202	Oscillating Hook Bell Crank.....
32783	26201	Throat Plate.....
33602R	26200	Arm Rock Shaft with 905E, for 33661.....
33603	26200	Arm Shaft for 33662.....
33609R	26200	Feed Forked Connection for 33664.....



No.	Plate	Name
195128	26212	Spotlight Body (upper half) for 195233 .....
195129	26212	Spotlight Body Snap Ring (large) for 195233..
195130	26212	Spotlight Body Snap Ring (small) for 195233
195132	26212	Spotlight Lamp Socket for 195135 .....
195133	26212	Spotlight Lens (blue glass) for 195233.....
195134	26212	Spotlight Lens Tension Spring for 195233....
195135	26212	Spotlight Lead with 195132 for 195233.....
195140	26212	Spotlight Switch Spring Contact (lamp side) for 195233 .....
195141	26212	Spotlight Switch Spring Contact (lead side) for 195233 .....
195143	-----	Spotlight Switch Key Snap Ring for 195233...
195148	26212	Spotlight Lamp for 195233 .....
		NOTE: When ordering No. 195148, state voltage required.
195224	26212	Spotlight Bracket for 195233 .....
195233	26212	Spotlight (blue glass lens) complete, Nos. 177X, 51463XC, 195127, 195128, 195129, 195130, 195133, 195134, 195135, 195140, 195141, 195143, 195148, 195224, 195227 196240 and 196625 .....
195540	26210	Armature Shaft Bearing.....
195541	26210	Armature Shaft Bearing Retainer.....
195871	-----	Field Core complete for RF5-7 and RF5-8 Motors .....
195957	26212	Spotlight Switch Rotating Contact with Cam and Insulator for 195233 .....
196240	26212	Spotlight Switch Key for 195233 .....
196625	-----	Spotlight Screw Retaining Washer for 195233..
196819	26211	Controller Back Cover for 196906 .....
196824	26211	Controller Back Cover Cushion for 196906.....
196826	26211	Controller Housing for 196906 .....
196827	26211	Controller Resistance Unit complete for 196906
196832	26210	Brush Holder Spacing Bushing .....
196849	26211	Controller Insulation for 196906.....
196881	26211	Controller Lead Bushing for 196924.....
196903	26211	Lead Cord Complete .....
196906	26211	Controller complete, Nos. 50939, 140686, 196819, 196826, 196827, 196849, 196924, 931055, two 701992, three 1783 and four 196824 .....
196924	26211	Controller Lead with 196881 and 197612, for 196906 .....
197275	26210	Armature complete for RF5-8 Motor .....
197276	26210	Field Core with Coils and Terminals complete for RF5-8 Motor .....
197277	-----	Field Coils Complete for RF5-8 Motor .....
197278	26210	End Cover (pulley end).....

No.	Plate	Name
197279	26210	End Cover (commutator end).....
197280	-----	Armature complete for RF5-7 Motor.....
197281	-----	Field Core with Coils and Terminals complete for RF5-7 Motor.....
197282	-----	Field Coils complete for RF5-7 Motor .....
197293	26210	Brush Holder .....
197611	26210	Brush Tube Insulation .....
197612	26211	Controller Lead Strain Relief for 196924.....
197612	26211	Lead Strain Relief .....
197613	26211	Lead Cord Plug .....
198651	26210	Belt (moulded) .....
701734	26210	Motor Screw Washer .....
701992	26211	Controller Resistance Unit Screw Nut Washer for 196906 .....
887915	26210	Lead Connector (small) .....
888043	26210	Lead Connector (large) .....
931055	-----	Controller Back Cover Screw Washer for 196906.....
931744	26210	Armature Shaft Thrust Washer (1/64 in.).....
931745	-----	Armature Shaft Thrust Washer (1/32 in.).....
931746	-----	Armature Shaft Thrust Washer (3/64 in.).....
964514	26210	Field Coils Retainer .....

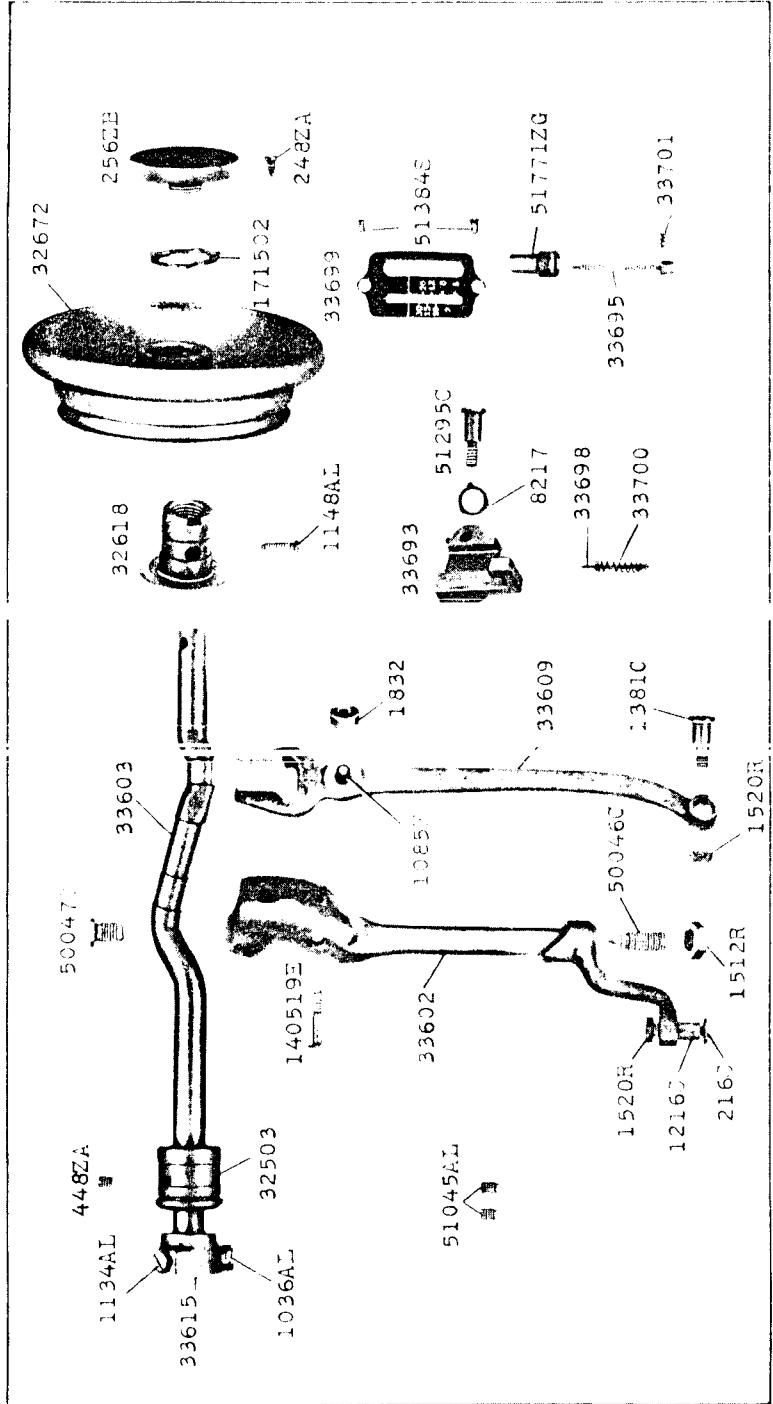

26201-1/2

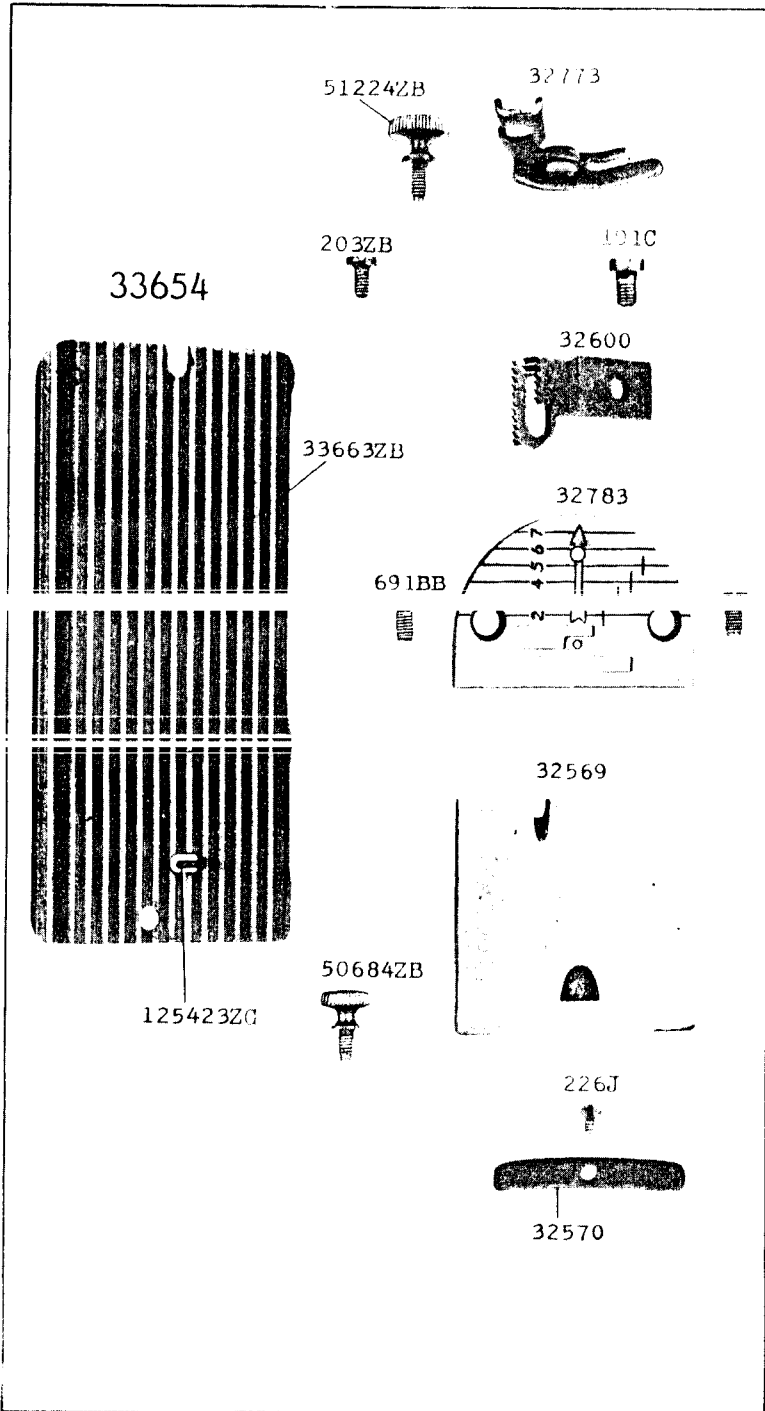

26202-1/2

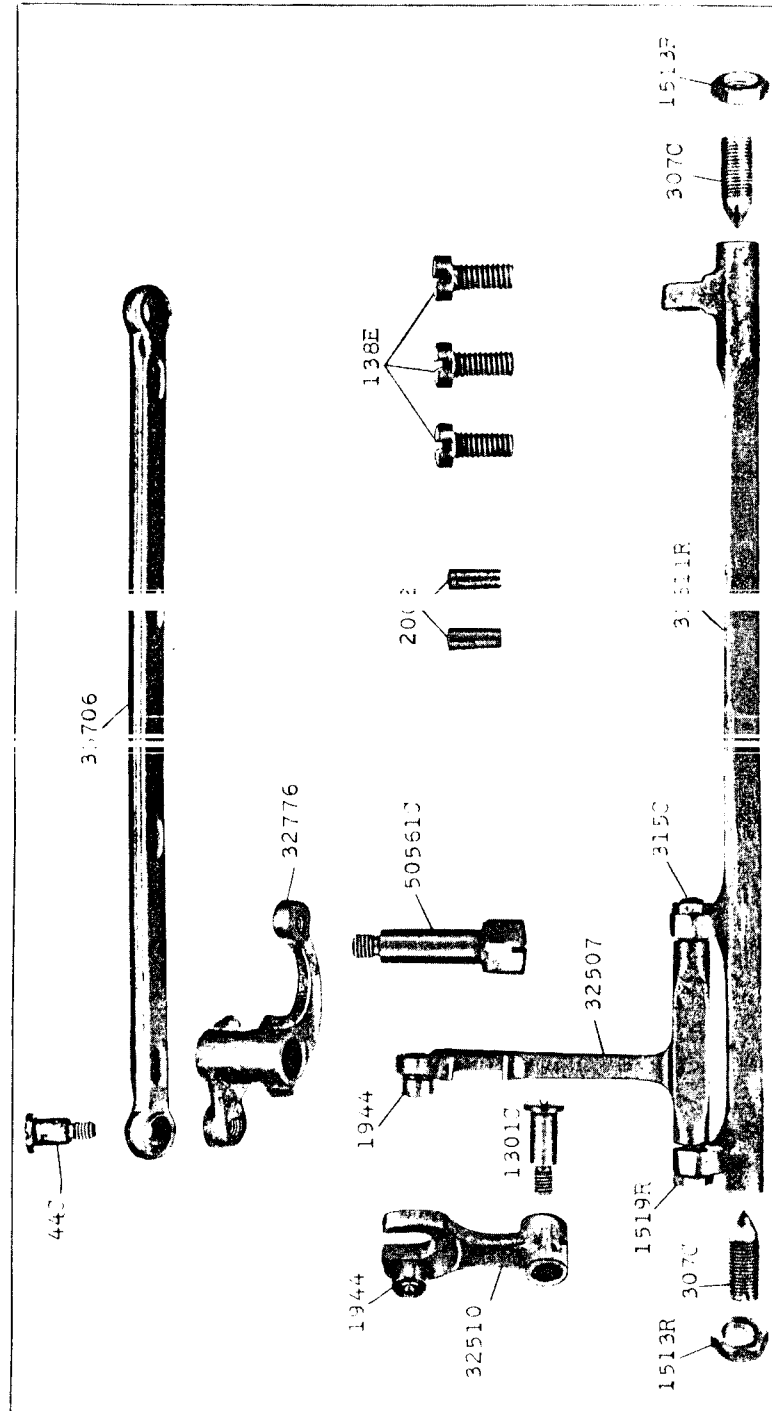





26205-2/3

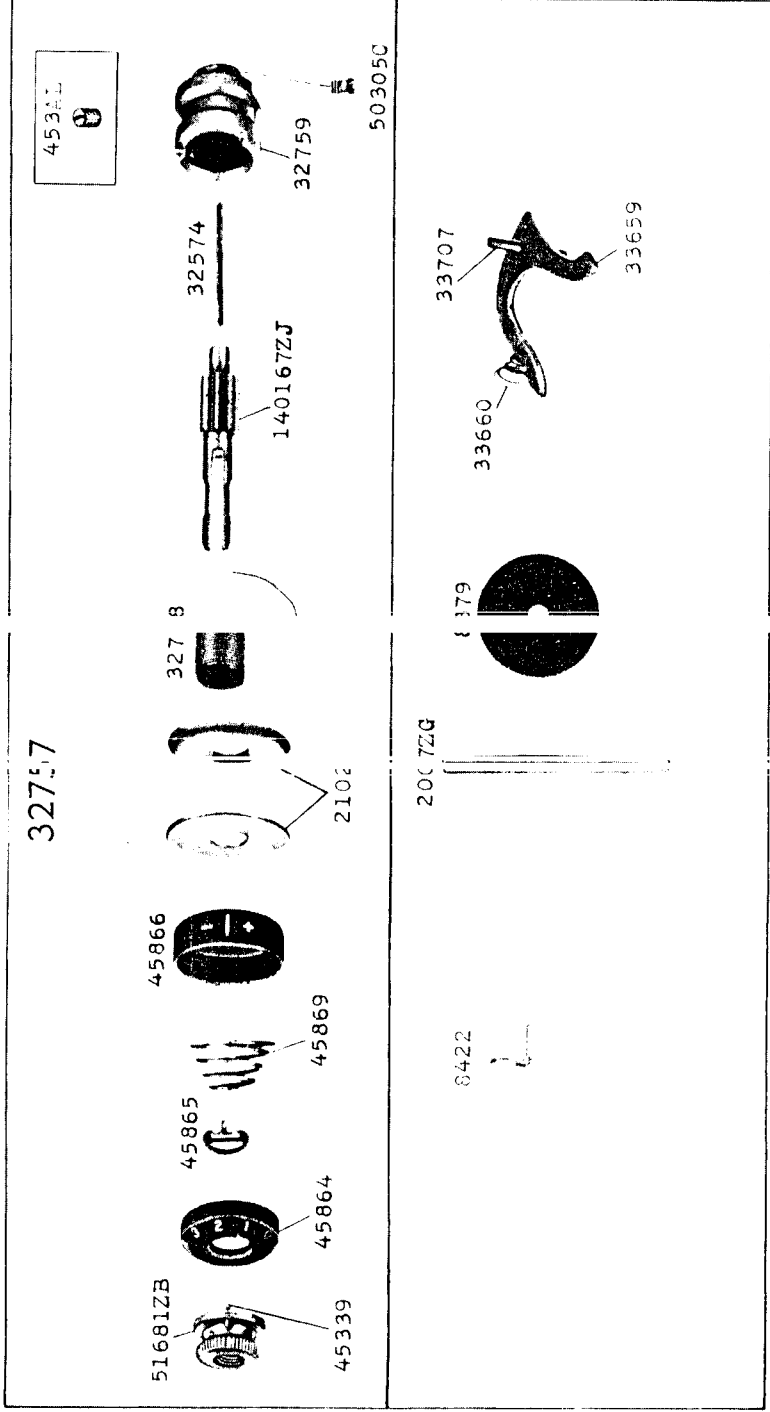

26206 1/2

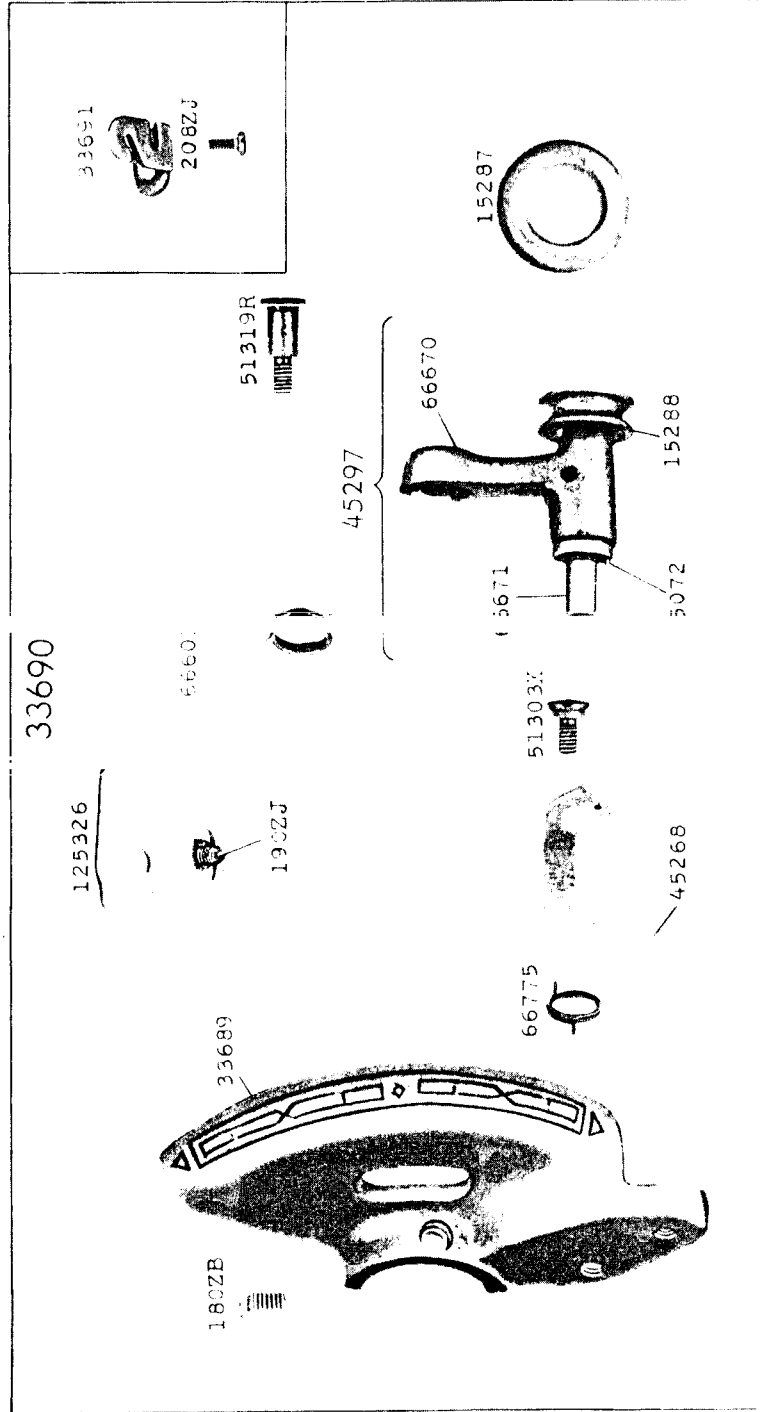

26207-1/2

161119

161208

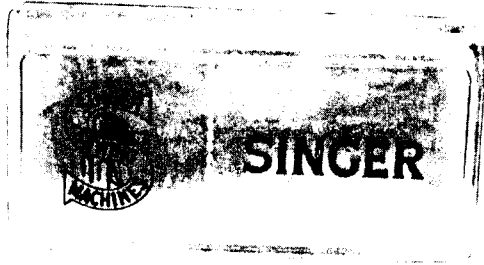

161133

120378



25527

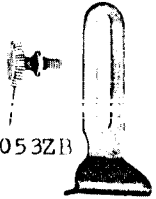

50053ZB

32622



161127

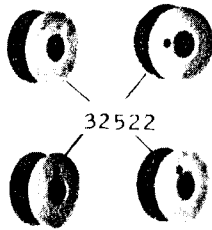
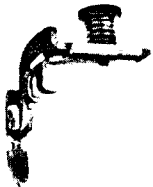

32522

26208-2/3

289B



25510

25893



25978



36058



36059

665B

36067



36333



120842



121441

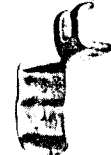

121614



121615

51282J

35932



25539



121725



120687

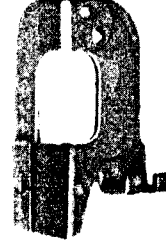

26209-2/3

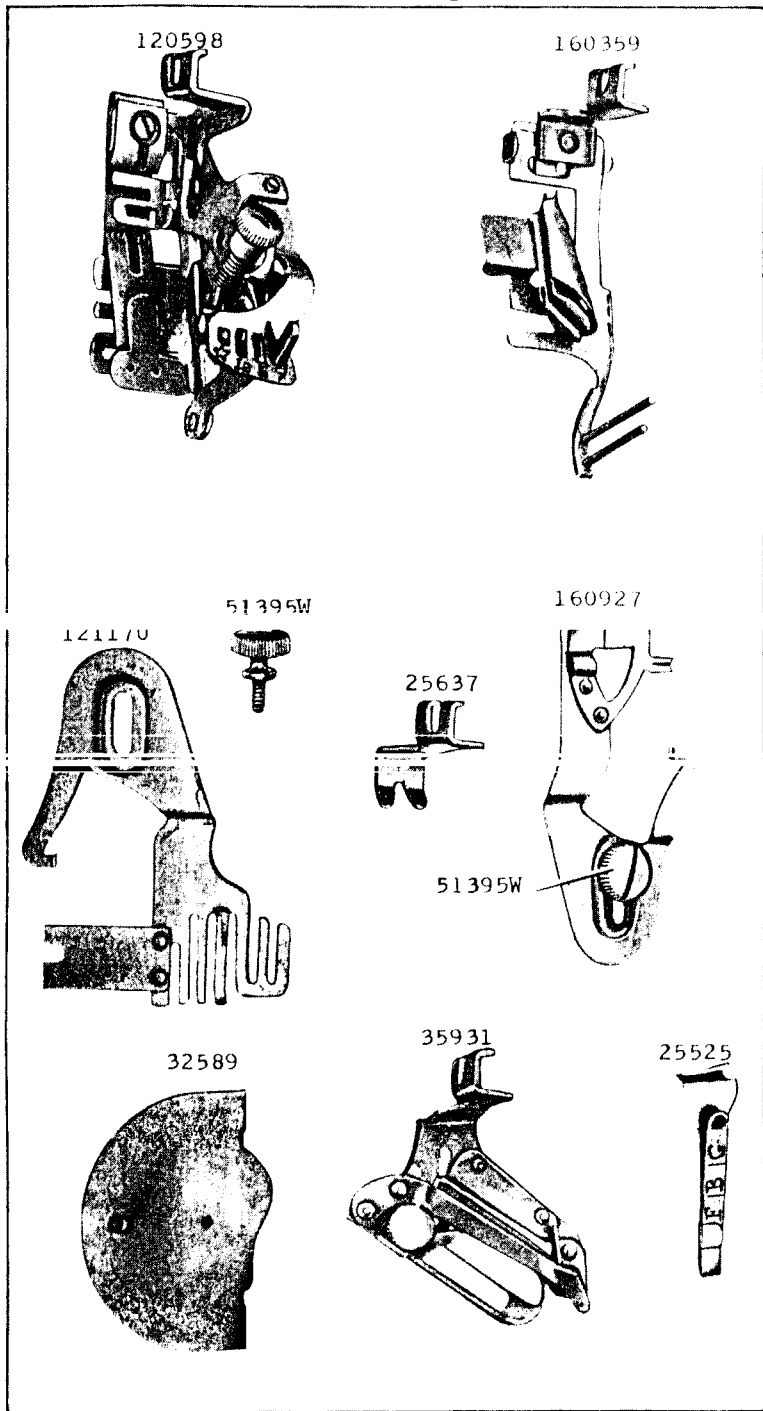

26210-1/3

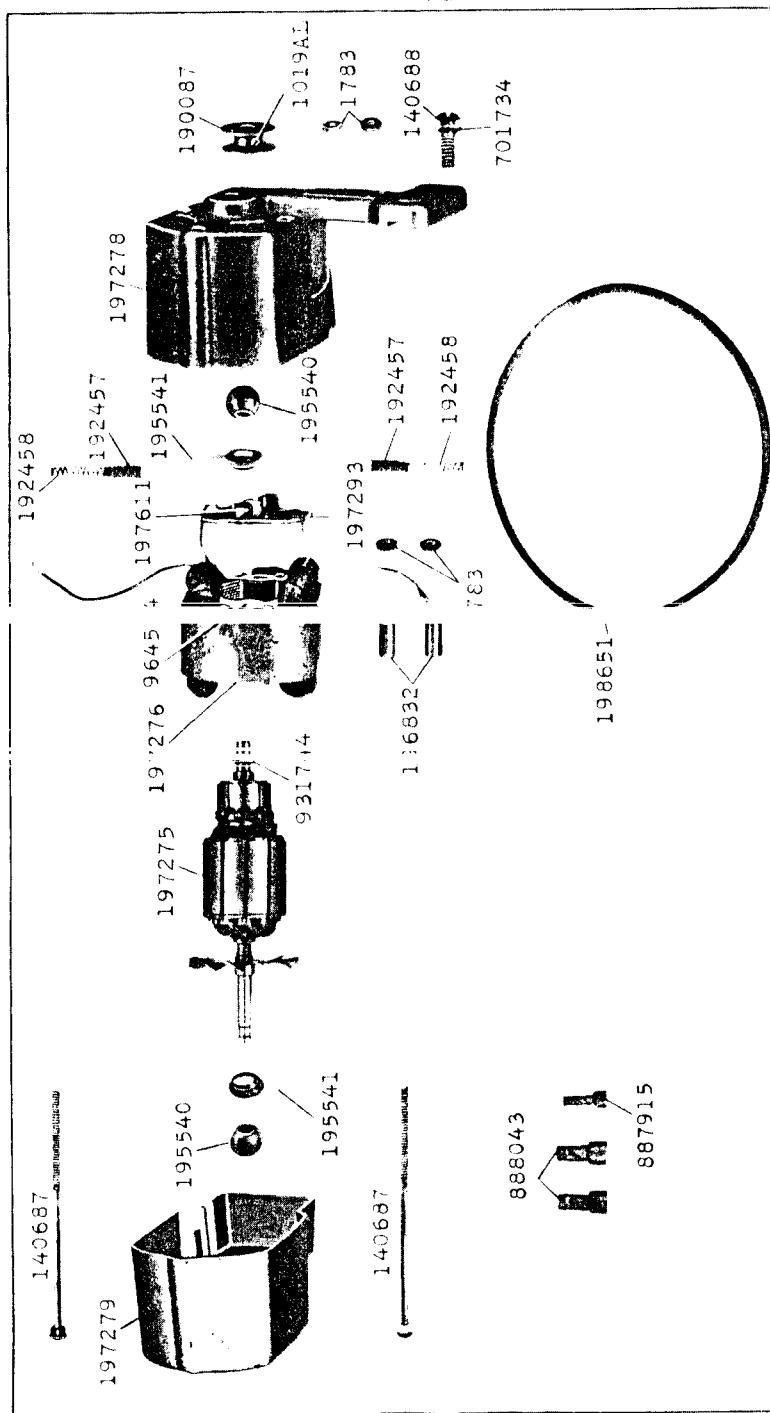

26211-1/3

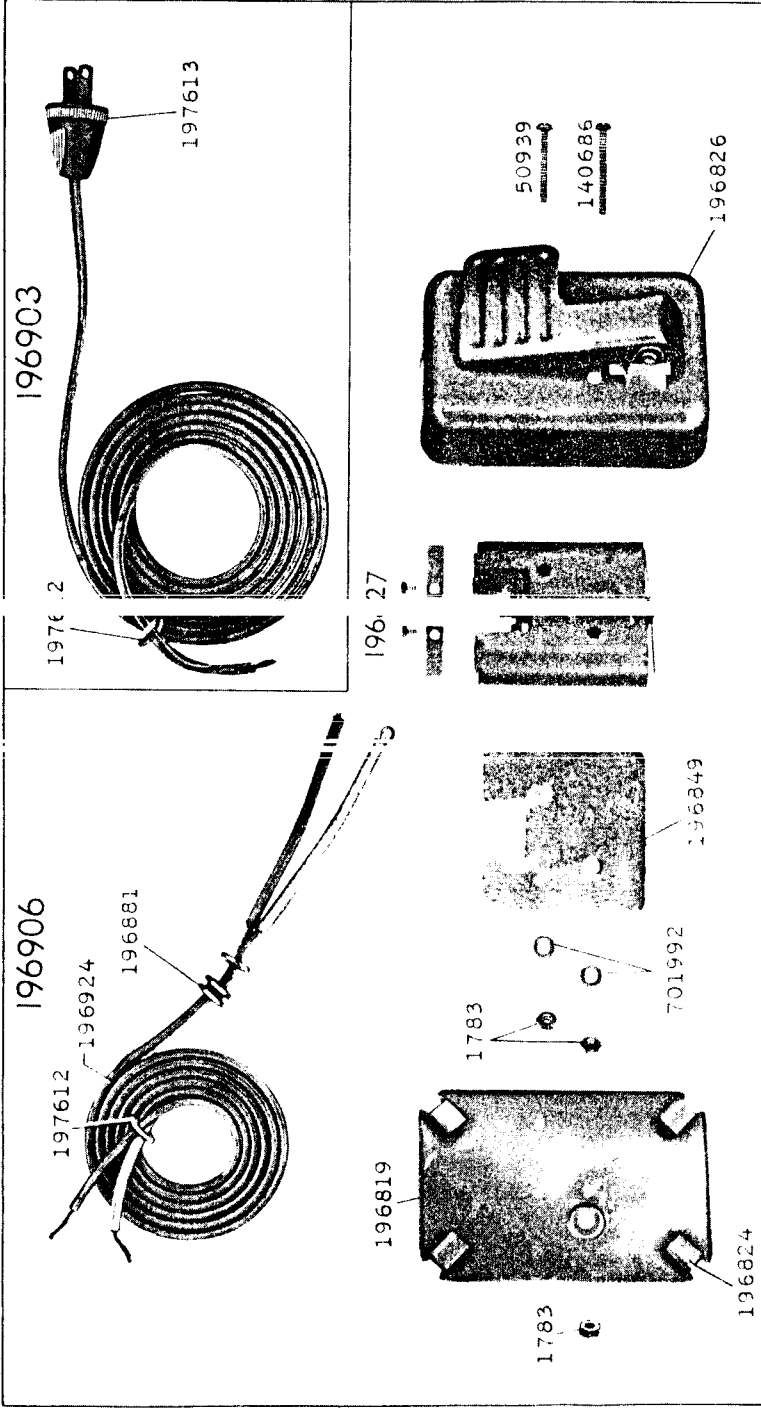

26212-1/2

