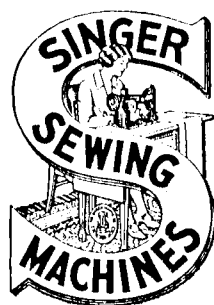


**SINGER**  
107W4,W7

# LIST OF PARTS



## MACHINES Nos. 107w4 and 107w7

THE SINGER MANUFACTURING COMPANY

### INDEX

	PAGE
ACCESSORIES .....	30
ARM CAP AND THREAD GUIDE .....	32
BOBBIN WINDER .....	30
GUIDES .....	36
KNEE LIFTER .....	31
LACE GUIDES .....	33
MACHINE No. 107w4 .....	7
"      "   107w7 .....	17
NUMERICAL LIST OF PARTS .....	37
OBSOLETE PARTS .....	36
PRESSER FEET .....	35
SPOOL HOLDER .....	33

# Instructions for Ordering

In ordering from this list, use **ONLY** the **PART** number in the **FIRST** column.

The number stamped on a Sewing Machine Part is the number of the Single Part only, except when the part includes Set Screws, Clamping Screws, Studs and Rollers Spun on, Small Wires riveted, or Parts soldered together, etc., which it is necessary to furnish in combination.

Every combination of parts sent out has its specific number which, although not stamped on Parts (except in above case), must be used when ordering the combination.

Each number always indicates the **SAME PART** in whatever list it appears, or for whatever Machine.

The letters after some of the numbers indicate the style of finish only, as follows:

- A. Hardened, Polished and Plated.
- B. Polished and Plated.
- C. Hardened only.
- D. Polished only.
- E. Soft, not polished.
- F. Hardened and Polished.
- H. Blued.

These letters **MUST BE USED** when they appear in the list and **AFTER** the number, as in the list.

In this series

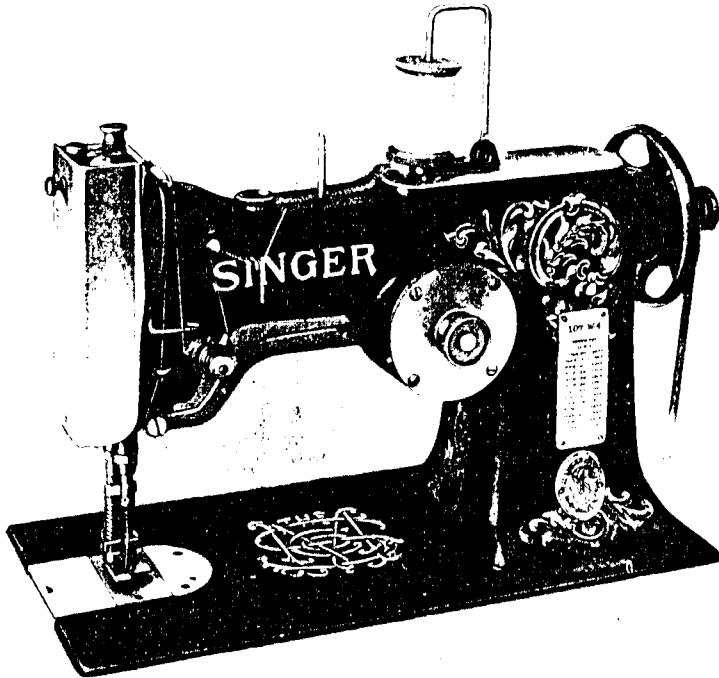
- 200001 to 201500 are Screw Numbers.
- 201501 to 201800 are Nut Numbers.
- 201801 to 202000 are Roller Numbers.
- 202001 and upward are Numbers of Machine Parts.

The figures in the second column refer only to the plate in which the illustration of the part is shown and are **NOT TO BE USED** in ordering.

Two or more numbers over a cut indicate that the difference between such parts is not visible in an illustration.

Parts marked with an asterisk (\*) are furnished only when repairs are made at the factory.

## LIST OF PARTS COMPLETE FOR



### MACHINE No. 107w4

HIGH SPEED ZIGZAG  
TRANSVERSE ROTARY HOOK. LOCK STITCH

Has Gathering Feed, for Overlapping and Abutting  
Lace Trimming to Knit Goods

No.	Plate	Name
*210501		Arm .....
203087	10751	" Cap .....
200278n	10755	" " Screw .....
202248	10755	" " Washer .....
203089	10751	" " Spool Holder Base .....
203090		" " " " " 203089 with 200079n and 204296 .....
200585n	13182	Arm Cap Spool Holder Base Screw .....
204296	10751	" " " " Wire .....
200079n	13182	" " " " Hinge Screw .....

No.	Plate	Name
203088	10751	Arm Cap and Spool Holder complete, Nos. 203087, 203090 and two 200585u .....
204235	10755	Arm Position Pin (2) .....
200010e	10755	" Screw (3) .....
202005	10755	" " Washer (2) .....
202249	10753	" Shaft with 200357e and 203100 .....
202243	10753	" " Bushing (back) with 202244 .....
202244	---	Arm Shaft Bushing (back) Oil Packing (wick) .....
200338c	10755	Arm Shaft Bushing (back) Set Screw .....
207080	10753	Arm Shaft Bushing (front) with 202244 .....
202244	---	Arm Shaft Bushing (front) Oil Packing (wick) .....
200502b	10755	Arm Shaft Bushing (front) Oil Packing Thumb Screw .....
200341c	10755	Arm Shaft Bushing (front) Set Screw .....
210503	10753	Arm Shaft Connection Belt .....
202635	10753	" " " " Pulley with 200327c, 200602e and two 202253 .....
200602e	10755	Arm Shaft Connection Belt Pulley Position Screw .....
200327c	10755	Arm Shaft Connection Belt Pulley Set Screw .....
202253	10757	Arm Shaft Connection Belt Pulley Spring Flange .....
203100	---	Arm Shaft Oil Packing (wick) ...
200357e	10755	" " " " Stop Screw ..
202255	10752	Balance Wheel (belt groove, 2 1/4 in. diam.) with 200328c and 200335c .....
200328c	10755	Balance Wheel Position Screw ...
200335c	10755	" " Set Screw .....
*210790	---	Bed .....
202258	10751	" Hinge Connection (2) .....
200570e	10755	" " " Screw (4) ....
210505b	10751	" Plate (back) .....
200577h	13182	" " " Screw (2) .....
210616	10751	" Slide (front) .....
210530	13182	Bobbin .....
210846	10736	" Case Base .....
210729	10736	" " Cap with 200592c, 201016f and 210845 .....
210915	10736	Bobbin Case Cap complete, Nos. 200964e, 210729, 210736 and 210914 .....

No.	Plate	Name
210913	10736	Bobbin Case Latch .....
210914	---	" " " 210913 with 210731 and 210735 .....
210735	13182	Bobbin Case Latch Fulcrum Pin ..
210731	13182	" " " Lever .....
210736	13182	" " " Spring .....
200964e	13182	" " " Stop Screw ...
210764	13182	" " Stop .....
200076b	13182	" " " Screw .....
210845	13182	" " Tension Spring .....
201016f	10736	" " " " Regulat- ing Screw .....
200592c	13194	Bobbin Case Tension Spring Screw .....
210847	10736	Bobbin Case complete, Nos. 210846 and 210915 .....
210681	15277	Face Plate .....
202135	10755	" " Position Pin .....
200462b	10755	" " Thumb Screw .....
210792	10739	Feed Bar (auxiliary) with 200362c .....
210795	---	" " 210792 with 210796 and 210808 .....
210794	10739	Feed Bar with 200362c .....
210793	---	" " 210794 with 210796 and 210807 .....
210796	10739	Feed Bar Hinge Pin .....
210796	10739	" " " " (auxiliary) ..
210835	10739	" " Slide Block .....
210797	10739	" " " " (auxiliary) ..
210836	10739	" " " " Crank with 200048b .....
210834	---	Feed Bar Slide Block Crank 210836 with 200939c, 201528e, 210797 and 210835 .....
200048b	13194	Feed Bar Slide Block Crank Pinch Screw .....
200939c	10739	Feed Bar Slide Block Hinge Screw Stud (eccentric) .....
201528e	13194	Feed Bar Slide Block Hinge Screw Stud Nut .....
200362c	13194	Feed Bar Set Screw .....
200362c	13194	" " " " (auxiliary) ...
210798	15282	" Dog .....
210799	15282	" " (auxiliary) .....
200106e	10755	" " Screw (2) .....
200106e	10755	" " " (auxiliary) (2) ....
210800	10740	" Driving Connection with 200061b and 202277 .....
210801	---	Feed Driving Connection 210800 with 200545c, 201518e and 210802 .....

No.	Plate	Name
210802	10740	Feed Driving Connection (auxiliary)
210803	10739	" " " Crank with 200038c .....
210804	13194	Feed Driving Connection Crank (auxiliary) (indexed) with 200038c .....
200938c	10739	Feed Driving Connection Crank Hinge Stud (auxiliary) .....
210806	13194	Feed Driving Connection Crank Hinge Stud Index Washer (auxil- iary) .....
201518E	10755	Feed Driving Connection Crank Hinge Stud Nut (auxiliary) ....
210805	13194	Feed Driving Connection Crank Hinge Stud Washer (auxiliary)...
200038c	13194	Feed Driving Connection Crank Pinch Screw .....
200038c	13194	Feed Driving Connection Crank Pinch Screw (auxiliary) .....
200545c	13194	Feed Driving Connection Hinge Screw .....
200545c	13194	Feed Driving Connection Hinge Screw (auxiliary) .....
201518E	10755	Feed Driving Connection Hinge Screw Nut .....
201518E	10755	Feed Driving Connection Hinge Screw Nut (auxiliary) .....
202277	---	Feed Driving Connection Oil Pack- ing (wick) .....
200061D	15276	Feed Driving Connection Pinch Screw .....
202300	10753	Feed Driving Eccentric Regulating Bracket .....
203098	10753	Feed Driving Eccentric Regulating Bracket 202300 with 202625, two each 201014c and 201525E .....
201014c	13182	Feed Driving Eccentric Regulating Bracket Hinge Screw .....
201525E	10755	Feed Driving Eccentric Regulating Bracket Hinge Screw Nut .....
202301	10755	Feed Driving Eccentric Regulating Bracket Plunger .....
202595	10755	Feed Driving Eccentric Regulating Bracket Plunger Spring .....
200607c	10755	Feed Driving Eccentric Regulating Bracket Plunger Spring Stop Screw .....
201014c	13182	Feed Driving Eccentric Regulating Bracket Stop Screw .....

No.	Plate	Name
201525E	10755	Feed Driving Eccentric Regulating Bracket Stop Screw Nut .....
200429c	10755	Feed Driving Eccentric Regulating Screw .....
200383c	10755	Feed Driving Eccentric Regulating Screw Check Screw .....
210807	10740	Feed Driving Rock Shaft .....
210808	10740	" " " " (auxiliary)
210809	13194	" " " " Bushing ..
200363c	10736	" " " " " Set Screw .....
203244	13194	Feed Driving Rock Shaft Stop Col- lar with two 200393c .....
210833	13194	Feed Driving Rock Shaft Stop Col- lar (auxiliary) with two 200383c
200393c	13194	Feed Driving Rock Shaft Stop Col- lar Set Screw .....
200383c	10755	Feed Driving Rock Shaft Stop Col- lar Set Screw (auxiliary) .....
202306	10752	Feed Lifting Connection with 200054E and 202277 .....
*210645	---	Feed Lifting Connection Crank ....
210589	13194	" " " " * 210645 with 200050c and 200378c .....
200050c	13194	Feed Lifting Connection Crank Pinch Screw .....
200378c	13194	Feed Lifting Connection Crank Set Screw .....
202307	13194	Feed Lifting Connection Eccentric with 200382c and 200437c .....
200437c	13194	Feed Lifting Connection Eccentric Position Screw .....
200382c	13182	Feed Lifting Connection Eccentric Set Screw .....
200545c	13194	Feed Lifting Connection Hinge Screw .....
201518E	10755	Feed Lifting Connection Hinge Screw Nut .....
202277	---	Feed Lifting Connection Oil Pack- ing (wick) .....
200054E	10755	Feed Lifting Connection Pinch Screw .....
210531	10752	Feed Lifting Rock Shaft (hollow) and Hook Driving Shaft Bearing
202625	13194	Feed Lifting Rock Shaft Stop Col- lar with two 200383c .....
200383c	10755	Feed Lifting Rock Shaft Stop Col- lar Set Screw .....
202310	10753	Feed Regulating Spindle with 202311, 202443 and 202619 .....

No.	Plate	Name
*202311	---	Feed Regulating Spindle Head ....
202443	13195	" " " " Pin
202619	10756	" " " " Position Pin .....
*210532	---	Hook (sewing) .....
210533	15276	" 210532 with 200145c, 203101, 210536, 210541 and three 200596f
210775	---	Hook and Bobbin Case complete, Nos. 210533 and 210847 .....
210614	10757	Hook Driving Bevel Pinion (steel), 24 teeth, with two 200378c .....
200378c	13194	Hook Driving Bevel Pinion Set Screw .....
210535	10752	Hook Driving Bevel Pinion Shaft
202661	10753	" " " " " Belt Pulley with 202324 and two 200378c .....
200378c	13194	Hook Driving Bevel Pinion Shaft Belt Pulley Set Screw .....
202324	10757	Hook Driving Bevel Pinion Shaft Belt Pulley Spring Flange .....
210536	13182	Hook Gib .....
200596f	13183	" " Screw .....
203101	---	" Oil Wick .....
200915f	10757	" Position Screw .....
210537	10757	" Shaft (hollow) .....
210615	10757	" " Bevel Gear (steel), 24 teeth, with two 200382c .....
200382c	13182	Hook Shaft Bevel Gear Set Screw
210539	10757	" " Bushing .....
210621	---	" " " 210539 with 200931e and 210537 .....
200335c	10755	Hook Shaft Bushing Set Screw ...
200931e	10757	" " Position Screw .....
210541	15276	" Washer Needle Guard .....
200145c	13183	" " " " Screw ..
237837	15277	Knee Lifter Connection Lever ....
210876	---	" " " " 237837 with 202447, 210875 and two 200262H .....
200262H	15276	Knee Lifter Connection Lever Hinge Screw .....
202447	15277	Knee Lifter Connection Lever Lifting Rod with 202302 .....
202302	13195	Knee Lifter Connection Lever Lifting Rod Cotter Pin .....
210875	15277	Knee Lifter Lifting Lever .....
200262H	15276	" " " " Hinge Screw .....

No.	Plate	Name
202976	10761	Needle Bar (hollow) with 200141f
210543	10761	" " Connecting Link .....
202333	10761	" " " " Stud with 202254 .....
202254	---	Needle Bar Connecting Link Stud Oil Packing (wick) .....
200383c	10755	Needle Bar Connecting Link Stud Set Screw .....
200374c	10761	Needle Bar Connecting Link Stud Set Screw .....
210544	10761	Needle Bar Connecting Stud with 202277 .....
210585	---	Needle Bar Connecting Stud 210544 with 210545 .....
202277	---	Needle Bar Connecting Stud Oil Packing (wick) .....
210545	10761	Needle Bar Connecting Stud Swivel with 200387c .....
210725	10753	Needle Bar Crank with 200335c, 200374c, 200383c, 200428c and 202333 .....
203172	10761	Needle Bar Crank Friction Washer
200428c	10761	" " " Position Screw ..
200335c	10755	" " " Set Screw .....
210726	---	Needle Bar Crank complete, Nos. 202398 to 202400, 210543, 210585 and 210725 .....
210546	13185	Needle Bar Frame with 200070c ..
210542	---	" " " 210546 with 202976
210547	10756	" " " Guide Stud .....
200334c	10756	" " " " " Set Screw .....
210548	10756	Needle Bar Frame Hinge Stud ....
200334c	10756	" " " " " Set Screw .....
210556	15277	Needle Bar Frame Pitman with 200054e and 202277 .....
210557	10756	Needle Bar Frame Pitman Eccentric Stud .....
200070c	15276	Needle Bar Frame Pitman Eccentric Stud Set Screw .....
202277	---	Needle Bar Frame Pitman Oil Packing (wick) .....
200054e	10755	Needle Bar Frame Pitman Pinch Screw .....
200387c	15276	Needle Bar Set Screw .....
200141f	10761	" Set Screw .....
202300	10753	" Vibrator Eccentric Regulating (throw) Bracket .....

No.	Plate	Name
210550	-----	Needle Vibrator Eccentric Regulating (throw) Bracket 202300 with 210552, two each 200256d and 201525e .....
210551	15279	Needle Vibrator Eccentric Regulating Bracket Cover (plate) .....
200566d	10756	Needle Vibrator Eccentric Regulating Bracket Cover Screw (4) ...
210552	15279	Needle Vibrator Eccentric Regulating Bracket Flange with two 200383c .....
200383c	10755	Needle Vibrator Eccentric Regulating Bracket Flange Screw .....
200256d	10756	Needle Vibrator Eccentric Regulating Bracket Hinge Screw .....
201525e	10755	Needle Vibrator Eccentric Regulating Bracket Hinge Screw Nut ...
202301	10755	Needle Vibrator Eccentric Regulating Bracket Plunger .....
202595	10755	Needle Vibrator Eccentric Regulating Bracket Plunger Spring ....
200607c	10755	Needle Vibrator Eccentric Regulating Bracket Plunger Spring Stop Screw .....
200256d	10756	Needle Vibrator Eccentric Regulating Bracket Stop Screw .....
201525e	10755	Needle Vibrator Eccentric Regulating Bracket Stop Screw Nut ....
210699	15278	Needle Vibrator Gear (spiral) with two 200382c .....
203172	10761	Needle Vibrator Gear Friction Washer .....
200382c	13182	Needle Vibrator Gear Set Screw ...
210558	15279	" " " Shaft .....
210559	10756	" " " " Collar with two 200378c .....
200378c	13194	Needle Vibrator Gear Shaft Collar Set Screw .....
210700	15278	Needle Vibrator Pinion (spiral) with two 200382c .....
200382c	13182	Needle Vibrator Pinion Set Screw
200429c	10755	" " Regulating Screw
200383c	10755	" " " " " Check Screw .....
210553	15279	Needle Vibrator Regulating Spindle with 202583, 202619 and 210554 ...
*202583	-----	Needle Vibrator Regulating Spindle Head .....
202619	10756	Needle Vibrator Regulating Spindle Head Position Pin .....

No.	Plate	Name
210554	10756	Needle Vibrator Regulating Spindle Spring (flat) .....
244033		Presser Bar (hollow) .....
202335	10751	" " 244033 with 200074f ...
207072	15278	" " Bushing .....
200352c	15278	" " " Set Screw ....
202554	15280	" " Lifter .....
200653c	15280	" " " Hinge Screw ...
210789	15280	" " Lifting Releasing Lever Bracket .....
200260d	15280	Presser Bar Lifting Releasing Lever Bracket Guide Screw .....
206608	15280	Presser Bar Lifting Releasing Lever Bracket Spring .....
202337	15280	Presser Bar Position Guide .....
202338	15280	" " " " Lever with 200086f .....
200086f	15280	Presser Bar Position Guide Lever Pinch Screw .....
200352c	15278	Presser Bar Position Guide Set Screw .....
202343	10751	Presser Bar Spring .....
202346	15280	" " " Stop Rod .....
225832	15276	" " Stop Collar with 200113f
200113f	15276	" " " " Set Screw...
200492b	15280	" " Thumb Screw (pressure regulating) .....
200475b	15280	Presser Bar Thumb Screw Thumb Set Screw .....
202355	15276	Presser Bar Thumb Screw Thumb Set Screw Packing (brass) ....
210819	15282	Presser Foot (left) .....
210820		" " 210819 with 200175n and 210822 .....
210822	15282	Presser Foot (left) Gather Retainer Spring .....
200175n	15282	Presser Foot (left) Gather Retainer Spring Screw .....
210821	15282	Presser Foot (right) .....
210570	15282	" " Bracket .....
210571	15282	" " Guide with 200141f ...
200141f	10761	" " " Screw .....
210574	15282	" " Spring .....
202512	15282	" " Stop Pin .....
210823	15282	Presser Foot (hinged) (compensating) complete, Nos. 210570, 210820, 210821, two each 202512, 210571 and 210574 .....

No.	Plate	Name
200074F	15282	Presser Foot Screw .....
210591	10761	Take-up (auxiliary), for Swivel ...
200132E	10761	" " Screw .....
202398	10761	" Lever .....
202399	10761	" " Driving Stud with 202277
202277	...	" " " " Oil Packing (wick) .....
202400	10761	Take-up Lever Hinge Stud with 202423 .....
202423	...	Take-up Lever Hinge Stud Oil Packing (wick) .....
200383C	10755	Take-up Lever Hinge Stud Set Screw .....
202401	10761	Take-up Lever Oiling Felt .....
200132E	10761	" " " " Screw ..
244007	10762	Tension Disc (back) .....
244008	10762	" " (front) .....
202404	10762	" Release Plunger .....
202405	10762	" " Washer .....
202407	10881	" Spring .....
200625F	10762	" Stud with 204925 .....
200061C	15276	" " Set Screw .....
204925	15280	" " Washer .....
201572B	10881	" Thumb Nut .....
202409	10762	Tension complete, Nos. 200625F, 201572B, 202405, 202407, 202410, 244007 and 244008 .....
202410	10762	Thread Controller Spring .....
202411	10762	" " " Stop .....
200132E	10761	" " " " Screw .....
210593	10756	" Guide (lower) .....
224387	15280	" " .....
210595	10756	" " (on side of Arm) .....
202412	10756	" " (on top of Arm) .....
210592	10756	" " (upper) .....
200172H	10756	" " Screw .....
200582H	10756	" " " (2) .....
202091	10762	" Retainer Sleeve .....
202092	10762	" " Spring .....
204058	10762	" " Stud .....
200366H	10762	" " " Set Screw .....
204059	10762	Thread Retainer complete, Nos. 202091, 202092 and 204058 .....
210832	15282	Throat Plate, 53 needle hole, for needle sizes 12 and 13 .....
200577H	13182	Throat Plate Screw (2) .....

## LIST OF PARTS COMPLETE.

FOR

## MACHINE No. 107w7

HIGH SPEED ZIGZAG

TRANSVERSE ROTARY HOOK. LOCK STITCH

Has Gathering Feed, for Attaching Lace or Beading to  
Knitted Underwear and Trimming the Under  
Material at One Operation

No.	Plate	Name
*233045		Arm .....
203087	10751	" Cap .....
200278H	10755	" " Screw .....
202248	10755	" " Washer .....
203089	10751	" " Spool Holder Base .....
203090	...	" " " " " 203089 with 200079H and 204296 .....
200585H	13182	Arm Cap Spool Holder Base Screw
204296	10751	" " " " Wire .....
200079H	13182	" " " " " Hinge Screw .....
203088	10751	Arm Cap and Spool Holder com- plete, Nos. 203087, 203090 and two 200585H .....
204235	10755	Arm Position Pin (2) .....
200010C	10755	" Screw (3) .....
202005	10755	" " Washer (3) .....
233046	13181	" Shaft with 200357E and 203100
223607	13185	" " Bushing (back) with 202260 .....
202260		Arm Shaft Bushing (back) Oil Packing (wick) .....
200338C	10755	Arm Shaft Bushing (back) Set Screw .....
207080	10753	Arm Shaft Bushing (front) with 202244 .....
202244		Arm Shaft Bushing (front) Oil Packing (wick) .....
200502B	10755	Arm Shaft Bushing (front) Oil Packing Thumb Screw .....
200341C	10755	Arm Shaft Bushing (front) Set Screw .....



No.	Plate	Name
210503	10753	Arm Shaft Connection Belt .....
202635	10753	" " " " Pulley with 200327c, 200602e and two 202253 .....
200602e	10755	Arm Shaft Connection Belt Pulley Position Screw .....
200327c	10755	Arm Shaft Connection Belt Pulley Set Screw .....
202253	10757	Arm Shaft Connection Belt Pulley Spring Flange .....
203100		Arm Shaft Oil Packing (wick) ....
200357e	10755	" " " " Stop Screw ..
202255	10752	Balance Wheel (belt groove 2 1/2 in. diam.) with 200328c and 200335c
200328c	10755	Balance Wheel Position Screw ...
200335c	10755	" " Set Screw .....
*210850		Bed .....
202258	10751	" Hinge Connection (2) .....
200570e	10755	" " " Screw (4) ....
233048	13185	" Oil Cover .....
200161b	15276	" " " Screw (2) .....
210505	10751	" Plate (back) .....
200577u	13182	" " " Screw (2) .....
210616	10751	" Slide (front) .....
210530	13182	Bobbin .....
210846	10736	" Case Base .....
210729	10736	" " Cap with 200592c, 201016e and 210845 .....
210915	10736	Bobbin Case Cap complete, Nos. 200964e, 210729, 210736 and 210914
210913	10736	Bobbin Case Latch .....
210914		" " " 210913 with 210734 and 210735 .....
210735	13182	Bobbin Case Latch Fulcrum Pin ..
210734	13182	" " " Lever .....
210736	13182	" " " Spring .....
200964e	13182	" " " Stop Screw ....
210764	13182	" " Stop .....
200076b	13182	" " " Screw .....
210845	13182	" " Tension Spring .....
201016e	10736	" " " " Regulat- ing Screw .....
200592c	13194	Bobbin Case Tension Spring Screw
210847	10736	Bobbin Case complete, Nos. 210846 and 210915 .....
210851	13193	Face Plate .....
202135	10755	" " Position Pin .....
200462n	10755	" " Thumb Screw .....

No.	Plate	Name
210794	10739	Feed Bar with 200362c .....
210793		" " 210794 with 210796 and 210807 .....
210852	15277	Feed Bar (auxiliary) with 200362c
210853		" " 210852 with 210796 and 210808 .....
210796	10739	Feed Bar Hinge Pin .....
210796	10739	" " " " (auxiliary) ...
210835	10739	" " Slide Block .....
210797	10739	" " " " (auxiliary) ..
210836	10739	" " " " Crank with 200048b .....
210834		Feed Bar Slide Block Crank 210836 with 200939c, 201528e, 210797 and 210835 .....
200048b	13194	Feed Bar Slide Block Crank Pinch Screw .....
200939c	10739	Feed Bar Slide Block Hinge Screw Stud (eccentric) .....
201528e	13194	Feed Bar Slide Block Hinge Screw Stud Nut .....
200362c	13194	Feed Bar Set Screw .....
200362c	13194	" " " " (auxiliary) ....
210854	13191	" Dog .....
210855	13191	" " (auxiliary) .....
200106e	10755	" " Screw (auxiliary) (2) ..
200106e	10755	" " " (2) .....
202300	10753	" Driving Eccentric Regulating Bracket .....
203098	10753	Feed Driving Eccentric Regulating Bracket 202300 with 202635, two each 201014c and 201525e ....
201014c	13182	Feed Driving Eccentric Regulating Bracket Hinge Screw .....
201525e	10755	Feed Driving Eccentric Regulating Bracket Hinge Screw Nut .....
202301	10755	Feed Driving Eccentric Regulating Bracket Plunger .....
202595	10755	Feed Driving Eccentric Regulating Bracket Plunger Spring .....
200607c	10755	Feed Driving Eccentric Regulating Bracket Plunger Spring Stop Screw .....
201014c	13182	Feed Driving Eccentric Regulating Bracket Stop Screw .....
201525e	10755	Feed Driving Eccentric Regulating Bracket Stop Screw Nut .....
200429c	10755	Feed Driving Eccentric Regulating Screw .....

No.	Plate	Name
200383c	10755	Feed Driving Eccentric Regulating Screw Check Screw .....
210800	10740	Feed Driving Connection with 200061b and 202277 .....
210801	---	Feed Driving Connection 210800 with 200545c, 201518e and 210802
210802	10740	Feed Driving Connection (auxiliary)
210803	10739	" " " Crank with 200038c .....
210804	13194	Feed Driving Connection Crank (auxiliary) (indexed) with 200038c
200938c	10739	Feed Driving Connection Crank Hinge Stud (auxiliary) .....
210806	13194	Feed Driving Connection Crank Hinge Stud Index Washer (auxiliary) .....
201518e	10755	Feed Driving Connection Crank Hinge Stud Nut (auxiliary) ....
210805	13194	Feed Driving Connection Crank Hinge Stud Washer (auxiliary)...
200038c	13194	Feed Driving Connection Crank Pinch Screw .....
200038c	13194	Feed Driving Connection Crank Pinch Screw (auxiliary) .....
200545c	13194	Feed Driving Connection Hinge Screw .....
200545c	13194	Feed Driving Connection Hinge Screw (auxiliary) .....
201518e	10755	Feed Driving Connection Hinge Screw Nut .....
201518e	10755	Feed Driving Connection Hinge Screw Nut (auxiliary) .....
202277	---	Feed Driving Connection Oil Packing (wick) .....
200061b	15276	Feed Driving Connection Pinch Screw .....
210807	10740	Feed Driving Rock Shaft .....
210808	10740	" " " " (auxiliary)
210809	13194	" " " " Bushing
200363c	10736	" " " " " Set Screw .....
203244	13194	Feed Driving Rock Shaft Stop Collar with two 200393c .....
210833	13194	Feed Driving Rock Shaft Stop Collar (auxiliary) with two 200383c
200393c	13194	Feed Driving Rock Shaft Stop Collar Set Screw .....
200383c	10755	Feed Driving Rock Shaft Stop Collar Set Screw (auxiliary) .....

No.	Plate	Name
202306	10752	Feed Lifting Connection with 200054e and 202277 .....
*210645	---	Feed Lifting Connection Crank
210589	13194	" " " " " 210645 with 200050c and 200378c
200050c	13194	Feed Lifting Connection Crank Pinch Screw .....
200378c	13194	Feed Lifting Connection Crank Set Screw .....
202307	13194	Feed Lifting Connection Eccentric with 200382c and 200437c .....
200437c	13194	Feed Lifting Connection Eccentric Position Screw .....
200382c	13182	Feed Lifting Connection Eccentric Set Screw .....
200545c	13194	Feed Lifting Connection Hinge Screw .....
201518e	10755	Feed Lifting Connection Hinge Screw Nut .....
202277	---	Feed Lifting Connection Oil Packing (wick) .....
200054e	10755	Feed Lifting Connection Pinch Screw .....
210531	10752	Feed Lifting Rock Shaft (hollow) and Hook Driving Shaft Bearing
202625	13194	Feed Lifting Rock Shaft Stop Collar with two 200383c .....
200383c	10755	Feed Lifting Rock Shaft Stop Collar Set Screw .....
202310	10753	Feed Regulating Spindle with 202311, 202443 and 202619 .....
*202311	---	Feed Regulating Spindle Head ....
202443	13195	" " " " Pin
202619	10756	" " " " Position Pin .....
*210532	---	Hook (sewing) .....
233056	13182	" 210532 with 200145c, 203101, 210536, 233058 and three 200596c
233057	13182	Hook and Bobbin Case complete, Nos. 210847 and 233056 .....
210614	10757	Hook Driving Bevel Pinion (steel), 24 teeth, with two 200378c .....
200378c	13194	Hook Driving Bevel Pinion Set Screw .....
210535	10752	Hook Driving Bevel Pinion Shaft
202661	10753	" " " " " Belt Pulley with 202324 and two 200378c .....
200378c	13194	Hook Driving Bevel Pinion Shaft Belt Pulley Set Screw .....

No.	Plate	Name
202324	10757	Hook Driving Bevel Pinion Shaft Belt Pulley Spring Flange .....
210536	13182	Hook Gib .....
200596e	13184	" " Screw .....
203101	---	" Oil Wick .....
200915e	10757	" Position Screw .....
210537	10757	" Shaft (hollow) .....
210615	10757	" " Bevel Gear (steel), 24 teeth, with two 200382c .....
200382c	13182	Hook Shaft Bevel Gear Set Screw
210539	10757	" " Bushing .....
210621	---	" " " 210539 with 200931e and 210537 .....
200335e	10755	Hook Shaft Bushing Set Screw ....
200363e	10736	" " " " " " .....
202355	15276	" " " " " " Pack- ing (brass) .....
200931e	10757	Hook Shaft Position Screw .....
233058	15276	" Washer Needle Guard .....
200145e	13184	" " " " " Screw
237837	15277	Knee Lifter Connection Lever .....
210876	---	" " " " " 237837 with 202447, 210875 and two 200262n .....
200262n	15276	Knee Lifter Connection Lever Hinge Screw .....
202447	15277	Knee Lifter Connection Lever Lift- ing Rod with 202302 .....
202302	13195	Knee Lifter Connection Lever Lift- ing Rod Cotter Pin .....
210875	15277	Knee Lifter Lifting Lever .....
200262n	15276	" " " " " Hinge Screw .....
233059	13183	Knife .....
233060	13183	" Driving Eccentric with 200373c and 200380e .....
233061	13183	Knife Driving Eccentric Connection with two 145e .....
201059e	15276	Knife Driving Eccentric Connection Hinge Screw .....
145e	13183	Knife Driving Eccentric Connection Screw .....
200373c	13183	Knife Driving Eccentric Position Screw .....
200380e	15276	Knife Driving Eccentric Set Screw
233097	13181	" " Lever with 200076e ..
233063	13185	" " " Bracket with 200364e .....
205508	13183	Knife Driving Lever Bracket Posi- tion Pin (2) .....

No.	Plate	Name
200030n	13183	Knife Driving Lever Bracket Screw (2) .....
233064	13183	Knife Driving Lever Driving Con- nection .....
233065	13185	Knife Driving Lever Driving Con- nection Bracket .....
201256b	13183	Knife Driving Lever Driving Con- nection Bracket Screw (3) .....
200062n	13183	Knife Driving Lever Driving Con- nection Screw .....
233094	13195	Knife Driving Lever Driving Con- nection Slide Block .....
233067	13183	Knife Driving Lever Driving Con- nection Slide Block Crank with 200403c and 201054e .....
201054e	13183	Knife Driving Lever Driving Con- nection Slide Block Crank Posi- tion Screw .....
200403c	10761	Knife Driving Lever Driving Con- nection Slide Block Crank Set Screw .....
233068	13183	Knife Driving Lever Driving Con- nection Slide Block Link .....
201282f	13182	Knife Driving Lever Driving Con- nection Slide Block Link Hinge Screw .....
233098	13195	Knife Driving Lever Hinge Stud (eccentric) .....
200364e	13184	Knife Driving Lever Hinge Stud Set Screw .....
233071	13184	Knife Driving Lever Pitman .....
233072	---	" " " " 233071 with 1518e, 1697e, 1698e, 38446 and 222023 .....
*38444	---	Knife Driving Lever Pitman End Bearing (lower) .....
38446	13184	Knife Driving Lever Pitman End Bearing 38444 with 42524, 50016e and two 175e .....
50016e	13184	Knife Driving Lever Pitman End Bearing (lower) Ball Screw Stud
1518e	13184	Knife Driving Lever Pitman End Bearing (lower) Ball Screw Stud Nut .....
*42524	----	Knife Driving Lever Pitman End Bearing (lower) Cap .....
175e	15276	Knife Driving Lever Pitman End Bearing (lower) Cap Screw .....
1698e	13184	Knife Driving Lever Pitman End Bearing (lower) Check Nut .....

No.	Plate	Name
*38443	-----	Knife Driving Lever Pitman End Bearing (upper) .....
222023	13184	Knife Driving Lever Pitman End Bearing 38443 with 679c, 42525 and two 175E .....
679c	13184	Knife Driving Lever Pitman End Bearing (upper) Ball Screw Stud .....
*42525	-----	Knife Driving Lever Pitman End Bearing (upper) Cap .....
175E	15276	Knife Driving Lever Pitman End Bearing (upper) Cap Screw ....
1697c	13184	Knife Driving Lever Pitman End Bearing (upper) Check Nut ....
200076c	13182	Knife Screw .....
233073	13184	" Throw out Crank .....
200574b	13184	" " " Screw (2) ..
233074	13184	" " " Shaft .....
233075	13184	" " " " Spring .....
233076	13184	" " " " " Washer .....
233077	13184	Knife Throw-out Crank Shaft Stop Plunger .....
233078	13184	Knife Throw-out Crank Shaft Stop Plunger Spring .....
200383c	10755	Knife Throw-out Crank Shaft Stop Plunger Spring Stop Screw ....
233079	13184	Knife Throw-out Handle with 200084f .....
200084f	13184	Knife Throw-out Handle Pinch Screw .....
233080	13181	Knife Throw-out Shaft .....
233081	15276	" " " Bracket ...
202602	15276	" " " " " Position Pin (2) .....
200051f	15276	Knife Throw-out Shaft Bracket Screw (2) .....
225832	15276	Knife Throw-out Shaft Collar with 200113f .....
200113f	15276	Knife Throw-out Shaft Collar Set Screw .....
233082	15276	Knife Throw-out Shaft Crank with 200403c and 201054f .....
233083	15276	Knife Throw-out Shaft Crank Link .....
201107c	15276	" " " " " Hinge Screw (2) .....
201054f	13184	Knife Throw-out Shaft Crank Position Screw .....
200403c	10761	Knife Throw-out Shaft Crank Set Screw .....

No.	Plate	Name
52840	13195	Lace Guide Pin .....
52841	13195	" Guiding Roller (wood) .....
210856	13193	" " " Arm with 50235d and two 52840 .....
200110b		Lace Guiding Roller Arm Screw (2) .....
201537a		" " " " " Nut (2) .....
210857	13193	Lace Guiding Roller Arm complete, Nos. 1560b, 13710, 32572, 52841, 52843 and 210856 .....
52843		Lace Guiding Roller Friction Washer .....
13710	13195	Lace Guiding Roller Tension Spring .....
1560b	13195	" " " " " Thumb Nut .....
32572	13195	Lace Guiding Roller Tension Spring Washer .....
50235d	13195	Lace Guiding Roller Screw Stud ..
202976	10761	Needle Bar (hollow) with 200141f ..
210543	10761	" " Connecting Link .....
202333	10761	" " " " " Stud with 202254 .....
202254		Needle Bar Connecting Link Stud Oil Packing (wick) .....
200383c	10755	Needle Bar Connecting Link Stud Set Screw .....
200374c	10761	Needle Bar Connecting Link Stud Set Screw .....
210544	10761	Needle Bar Connecting Stud with 202277 .....
210585		Needle Bar Connecting Stud 210544 with 210545 .....
202277		Needle Bar Connecting Stud Oil Packing (wick) .....
210545	10761	Needle Bar Connecting Stud Swivel with 200387c .....
210525	10753	Needle Bar Crank with 200335c, 200374c, 200383c, 200428c and 202333 .....
203172	10761	Needle Bar Crank Friction Washer .....
200428c	10761	" " " Position Screw ..
200335c	10755	" " " Set Screw .....
210725		Needle Bar Crank complete, Nos. 202398 to 202400, 210543, 210585 and 210725 .....
210546	13185	Needle Bar Frame with 200070c ..
210542		" " " 210546 with 202976 ..
210547	10756	" " " Guide Stud .....
200334c	10756	" " " " " Set Screw .....

No.	Plate	Name
210548	10756	Needle Bar Frame Hinge Stud . . . .
200334c	10756	" " " " " Set Screw . . . . .
210705	15279	Needle Bar Frame Pitman . . . . .
210706	-----	" " " " " 210705 with 202277, 210712, 224353, two each 200919c and 201522e . . . . .
210557	10756	Needle Bar Frame Pitman Eccentric Stud . . . . .
200070c	15276	Needle Bar Frame Pitman Eccentric Stud Set Screw . . . . .
202277		Needle Bar Frame Pitman Oil Packing (wick) . . . . .
200387c	15276	Needle Bar Set Screw . . . . .
200141e	10761	" Set Screw . . . . .
210779	15278	" Vibrator Cam . . . . .
210780	-----	" " " 210779 with 200378c and 200383c . . . . .
200378c	13194	Needle Vibrator Cam Set Screw . . . . .
200383c	10755	" " " " " . . . . .
210718	15279	" " " Shaft . . . . .
210551	15279	" " " " Bearing and Cover . . . . .
200566d	10756	Needle Vibrator Cam Shaft Bearing and Cover Screw (4) . . . . .
210559	10756	Needle Vibrator Cam Shaft Collar with two 200378c . . . . .
200378c	13194	Needle Vibrator Cam Shaft Collar Set Screw . . . . .
210712	15278	Needle Vibrator Crank with 200378c and 200917c . . . . .
224353	15278	Needle Vibrator Crank Link . . . . .
200919c	15278	" " " " Hinge Screw (lower or upper) . . . . .
201522e	13182	Needle Vibrator Crank Link Hinge Screw (lower or upper) Nut . . . . .
210723	15278	Needle Vibrator Crank Link Oil Tube . . . . .
200917c	15278	Needle Vibrator Crank Position Screw . . . . .
200378c	13194	Needle Vibrator Crank Set Screw . . . . .
210711	15278	" " " Shaft . . . . .
210699	15278	" " Gear (spiral) with two 200382c . . . . .
203172	10761	Needle Vibrator Gear Friction Washer . . . . .
200382c	13182	Needle Vibrator Gear Set Screw . . . . .
210700	15278	" " Pinion (spiral) with two 200382c . . . . .

No.	Plate	Name
200382c	13182	Needle Vibrator Pinion Set Screw . . . . .
210770	15279	" " Regulating Lever with 200378c and 200917c . . . . .
210781	15279	Needle Vibrator Regulating Lever Position Bracket (indexed) with 200326c, 200378c, 200917c and 201531e . . . . .
200917c	15278	Needle Vibrator Regulating Lever Position Bracket Position Screw . . . . .
200378c	13194	Needle Vibrator Regulating Lever Position Bracket Set Screw . . . . .
200326c	15278	Needle Vibrator Regulating Lever Position Bracket Stop Screw . . . . .
201531e	15278	Needle Vibrator Regulating Lever Position Bracket Stop Screw Nut . . . . .
200917c	15278	Needle Vibrator Regulating Lever Position Screw . . . . .
200378c	13194	Needle Vibrator Regulating Lever Set Screw . . . . .
210772	15278	Needle Vibrator Regulator Lever Slide . . . . .
201556d	15278	Needle Vibrator Regulating Lever Slide Thumb Nut . . . . .
244033		Presser Bar (hollow) . . . . .
202335	10751	" " 244033 with 200074e . . . . .
207072	15278	" " Bushing . . . . .
200352c	15278	" " " Set Screw . . . . .
202554	15280	" " Lifter . . . . .
200653c	15280	" " " Hinge Screw . . . . .
210789	15280	" " Lifting Releasing Lever Bracket . . . . .
200260d	15280	Presser Bar Lifting Releasing Lever Bracket Guide Screw . . . . .
206608	15280	Presser Bar Lifting Releasing Lever Bracket Spring . . . . .
202337	15280	Presser Bar Position Guide . . . . .
202338	15280	" " " " Lever with 200086f . . . . .
200086f	15280	Presser Bar Position Guide Lever Pinch Screw . . . . .
200352c	15278	Presser Bar Position Guide Set Screw . . . . .
202343	10751	Presser Bar Spring . . . . .
202346	15280	" " " Stop Rod . . . . .
200492B	15280	" " Thumb Screw (pressure regulating) . . . . .
200475B	15280	Presser Bar Thumb Screw Thumb Set Screw . . . . .
202355	15276	Presser Bar Thumb Screw Thumb Set Screw Packing (brass) . . . . .

No.	Plate	Name
210858	13193	Presser Foot Edge Guide .....
200172n	10756	" " " " Screw ..
230795	15280	" " Hinge Pin .....
210859	13191	" " Lace Guide .....
200172n	10756	" " " " Screw ..
210860	.....	" " Plate .....
210861	13191	" " Roller, for fine lace..
200074e	15282	" " Screw .....
202923	.....	" " Shank .....
210862	13191	Presser Foot (hinged) complete, for fine lace, Nos. 202923, 210858 to 210861, 230795 and two 200172n
210591	10761	Take-up (auxiliary), for swivel ...
290132e	10761	" " Screw .....
202398	10761	" Lever .....
202399	10761	" " Driving Stud with 202277 .....
202277	.....	Take-up Lever Driving Stud Oil Packing (wick) .....
202400	10761	Take-up Lever Hinge Stud with 202423 .....
202423	.....	Take-up Lever Hinge Stud Oil Packing (wick) .....
200383e	10755	Take-up Lever Hinge Stud Set Screw .....
202401	10761	Take-up Lever Oiling Felt .....
200132e	10761	" " " " Screw..
244007	10762	Tension Disc (back) .....
244008	10762	" " (front) .....
202404	10762	" Release Plunger .....
202405	10762	" " Washer .....
202407	10881	" Spring .....
200625e	10762	" Stud with 204925 .....
200061e	15276	" " Set Screw .....
204925	15280	" " Washer .....
201572n	10881	" Thumb Nut .....
202409	10762	Tension complete, Nos. 200625e, 201572n, 202405, 202407, 202410, 244007 and 244008 .....
202410	10762	Thread Controller Spring .....
202411	10762	" " " " S C o p
200132e	10761	" " " " " Screw .....

No.	Plate	Name
210593	10756	Thread Guide (lower) .....
224387	15280	" " .....
200172n	10756	" " Screw .....
210595	10756	" " (on side of Arm) ....
262442	10756	" " (on top of Arm) ....
210592	10756	" " (upper) .....
200582n	10756	" " Screw (2) .....
202091	10762	" Retainer Sleeve .....
202092	10762	" " Spring .....
204058	10762	" " Stud .....
200366n	10762	" " " Set Screw ....
204059	10762	Thread Retainer complete, Nos. 202091, 202092 and 204058 .....
210869	.....	Throat Plate, 53 needle hole, for needle sizes 12 and 13 .....
233090	13195	Throat Plate Knife Cutting Plate
200583n	13195	" " " " " Screw .....
200577n	13182	Throat Plate Screw (2) .....
210870	13192	Throat Plate complete, 53 needle hole, for needle sizes 12 and 13, Nos. 200583n, 210869 and 233090

## ACCESSORIES

FOR MACHINE No. 107w4

No.	Plate	Name
200157b	15281	Attachment Screw .....
210530	13182	Bobbin .....
*225482	---	" Case Screw Driver Blade ...
*225483	---	" " " " Handle ...
225497	12345	Bobbin Case Screw Driver complete, Nos. 225482 and 225483 ...
135 x 5	---	Needles, three each, sizes 12 and 14
228212	---	Drip Pan with four 1 in. wire nails
41400	12345	Machine Rest Pin (wood) .....
120342	12345	Oiler (copper plated) with 120343
120343	12345	" Spout, 3½ in. long, for 120342
*225484	---	Screw Driver Blade .....
*225485	---	" " Handle .....
225498	12345	Screw Driver complete (7½ in. long), Nos. 225484 and 225485 ...
225554	12345	Wrench (steel) .....

### BOBBIN WINDER

225453	10884	Frame with 202277 and 225438 ....
225454	10884	" Hinge Pin .....
202277	---	" Oil Packing (wick) .....
225438	10884	" " Well Cap .....
225455	10884	" Spring .....
225456	10884	" " Plunger .....
202473	10885	Pulley with 200380c .....
200380c	15276	" Set Screw .....
225381	10884	Spindle .....
225444	10884	Stop Latch .....
200056e	10884	" " Screw .....
225458	10884	" " Thumb Lever .....
225459	10884	" " " " Hinge Stud
225459	10884	" " " " Joint Stud
202478	10884	" " Trip Lever .....
200299n	10884	" " " " Hinge Screw
225461	10881	Tension Bracket with 201499n ....
200082b	10881	" " Screw .....
228026	10884	" " " Washer .....
2102	10881	" Disc .....
202407	10881	" Spring .....
201499n	10881	" Stud .....
201572n	10881	" " Thumb Nut .....

No.	Plate	Name
225462	10881	Bobbin Winder Tension Bracket complete, Nos. 201572n, 202407, 225461 and two 2102 .....
225433	10885	Bobbin Winder and Tension Bracket Base .....
225382	10885	Universal Bobbin Winder complete, Nos. 200056e, 200082b, 200299n, 202473, 202478, 225381, 225433, 225444, 225453 to 225456, 225458, 225462, 228026, two each 225459 and wood screws ¼ in., No. 12, R.H.B. ....

### KNEE LIFTER

2763	13395	Rock Shaft .....
228278	13395	" " Hanger (back) with 356c
228280	13395	" " " (front) with two 356c .....
228279	13395	Rock Shaft Hanger 228278 with 202452 and 228282 .....
228281	13395	Rock Shaft Hanger 228280 with 202452 and 228282 .....
228282	13395	Rock Shaft Hanger Bracket with two wood screws ¼ in., No. 12 ...
202452	---	Rock Shaft Hanger Hinge Pin ...
228283	13395	" " Lifting Lever with two 356c .....
227728	13395	Rock Shaft Lifting Lever Rod with 227729 .....
227729	---	Rock Shaft Lifting Lever Rod Cap
356c	---	" " " " " " Set Screw .....
356c	---	Rock Shaft Lifting Lever Set Screw
202455	13395	" " Knee Arm .....
356c	---	" " " " Set Screw ...
228281	13395	" " " " Plate with 356c ...
356c	---	" " " " Set Screw ...
356c	---	" " " " Set Screw .....
228285	13395	Rock Shaft complete, Nos. 2763, 202455, 227728, 228279, 228281, 228283 and 228284 .....

(Other Knee Lifter Parts are listed with parts of machine head)

## FOR MACHINE No. 107w7

Same as Machine No. 107w4 with the following exceptions:

No.	Plate	Name
233059	13184	Knife .....
233090	13195	Throat Plate Knife Cutting Plate... (200157b Attachment Screw, not used)

**ARM CAP AND THREAD GUIDE**

210848	13193	Arm Cap .....
223604	15281	" " Thread Guide .....
223605		" " " " 223604 with 210991 and two 200179u .....
210991	15281	Arm Cap Thread Guide Latch Spring .....
200179u	15281	Arm Cap Thread Guide Latch Spring Screw .....
200172u	10756	Arm Cap Thread Guide Screw ....
210849	13193	Arm Cap and Thread Guide com- plete, Nos. 210848, 223605 and two 200172u .....

**SPOOL HOLDER**

No.	Plate	Name
25362		Spool Holder Ball, size $\frac{3}{8}$ inch ....
204100	15281	" " " Bearing Cup ...
210825	15281	" " " " " " Po- sition Spring .....
204101	15281	Spool Holder Ball Cap .....
204102	15281	" " " Retaining Spring
227553	- -	Spool Holder Ball Cup complete, Nos. 204100 to 204102 and thirteen 25362 .....
210824	10782	Spool Holder Base with 200383c ..
210826	10782	" " Rod .....
200383c	10755	" " " Set Screw .....
210827	10782	" " Tension Disc .....
210828	10782	" " " Spring .....
210829	10782	" " " " Collar with 200731e .....
200731e	15281	Spool Holder Tension Spring Collar Thumb Screw .....
210831	10782	Spool Holder complete, Nos. 210824 to 210829, 227553 and three wood screws 1 in., No. 12 .....

**LACE GUIDES**

FOR MACHINE No. 107w4

Lace Guide (lower) for Abutting Lace Against  
a Garment

210810	10750	Lace Guide .....
210814	10750	" " (swing) Bracket .....
200157b	15281	" " " " Screw ..
200457b	15281	" " Hinge Screw .....
201526e	15281	" " " " Nut .....
226071	15281	" " " " Spring Washer .....
210815	15281	Lace Guide Position Stop .....
200137u	15281	" " " " Screw ..



No.	Plate	Name
210811	10750	Lace Guide complete, for abutting lace against a garment, Nos. 200157r, 201526E, 210810, 210811, 210815, 226071 and two 200137u

**Lace Guide (lower) for Overlapping a Garment with Lace**

210812	-	Lace Guide .....
210814	10750	" " (swing) Bracket .....
200157r	15281	" " " " Screw ..
200157r	15281	" " Hinge Screw .....
201526E	15281	" " " " Nut .....
226071	15281	" " " " Spring Washer .....
210815	15281	Lace Guide Position Stop .....
200137u	15281	" " " " Screw ..
210813	10750	Lace Guide complete, for overlapping a garment with lace, Nos. 200157r, 201526E, 210812, 210814, 210815, 226071 and two 200137u..

**Lace Guide (upper)**

210816	10750	Lace Guide with 200862E .....
210817	10750	" " Bracket (also Thread Guide) .....
210818	-	Lace Guide Bracket 210817 with 201581r and 210816 .....
200160r	15281	Lace Guide Bracket Screw .....
200862E	15281	" " Screw Stud .....
201581r	15281	" " " " Wing Nut..
210837	-	Automatic Lace Guide Combination complete, Nos. 200160r, 210811, 210818 and 210831, for abutting..
210838	-	Automatic Lace Guide Combination complete, Nos. 200160r, 210813, 210818 and 210831, for overlapping

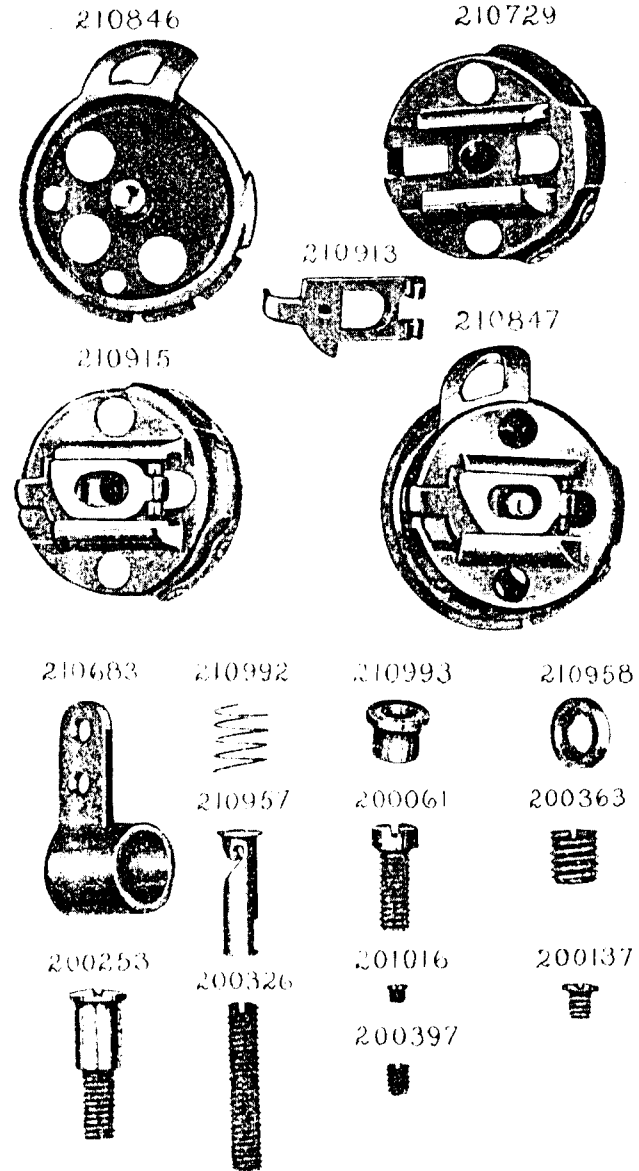
## PRESSER FEET

FOR MACHINE No. 107w7

No.	Plate	Name
210858	13191	Presser Foot Edge Guide .....
200172u	10756	" " " " Screw ..
230795	15280	" " Hinge Pin .....
210859	13191	" " " " Lace Guide .....
200172u	10756	" " " " Screw ..
210860	-	" " Plate .....
210863	13191	" " Roller, for coarse lace
202923	"	" " Shank .....
210864	15281	Presser Foot (hinged) complete, for coarse lace, Nos. 202923, 210858 to 210860, 210863, 230795 and two 200172u .....
210865	13192	Presser Foot Edge Guide .....
200172u	10756	" " " " Screw ..
230795	15280	" " Hinge Pin .....
210866	"	" " Plate .....
202923	"	" " Shank .....
210867	13192	" " Tubing Guide, for tubing from $\frac{3}{8}$ to $\frac{7}{8}$ in. wide, in steps of $\frac{1}{8}$ inch .....
200172u	10756	Presser Foot Tubing Guide Screw..
210868	13192	Presser Foot (hinged) complete, for silk or knit tubing from $\frac{3}{8}$ to $\frac{7}{8}$ in. wide, in steps of $\frac{1}{8}$ in., Nos. 202923, 210865 to 210867, 230795 and two 200172u .....

# GRINDER

No.	Plate	Name
For Grinding Throat Plate Knife Cutting Plate		
206977	----	Emery Wheel, 2 in. diameter .....
206962	10957	" " Driving Shaft .....
201510b	10957	" " " " Nut .....
204101	15281	" " " " " " .....
		Washer .....
206963	10957	Emery Wheel Driving Shaft Pulley with two 200403c .....
200403c	10761	Emery Wheel Driving Shaft Pulley Set Screw .....
206969		Emery Wheel Washer (paper) ...
206964	10957	Frame with two 54897 .....
	54897	" Oil Cup .....
233106	15279	Slide Bracket with 200394c, 200457b and 200577u .....
200457b	10957	Slide Bracket Adjusting Screw ....
206966	10957	" " " " Slide Plate .....
200577u	13182	Slide Bracket Adjusting Screw Slide Plate Screw .....
200394c	10957	Slide Bracket Set Screw .....
206967	10957	" " Shaft .....
200577b	13182	Throat Plate Knife Cutting Plate Screw .....
233105		Grinder complete, Nos. 200577u, 201510b, 204101, 206962 to 206964, 206966, 206967, 206977, 233106 and two 206969 .....



## OBSOLETE PARTS

202245	10753	Arm Shaft Bushing (front) with 202036 and 202260 .....
--------	-------	---

PLATE 10739 -FULL SIZE

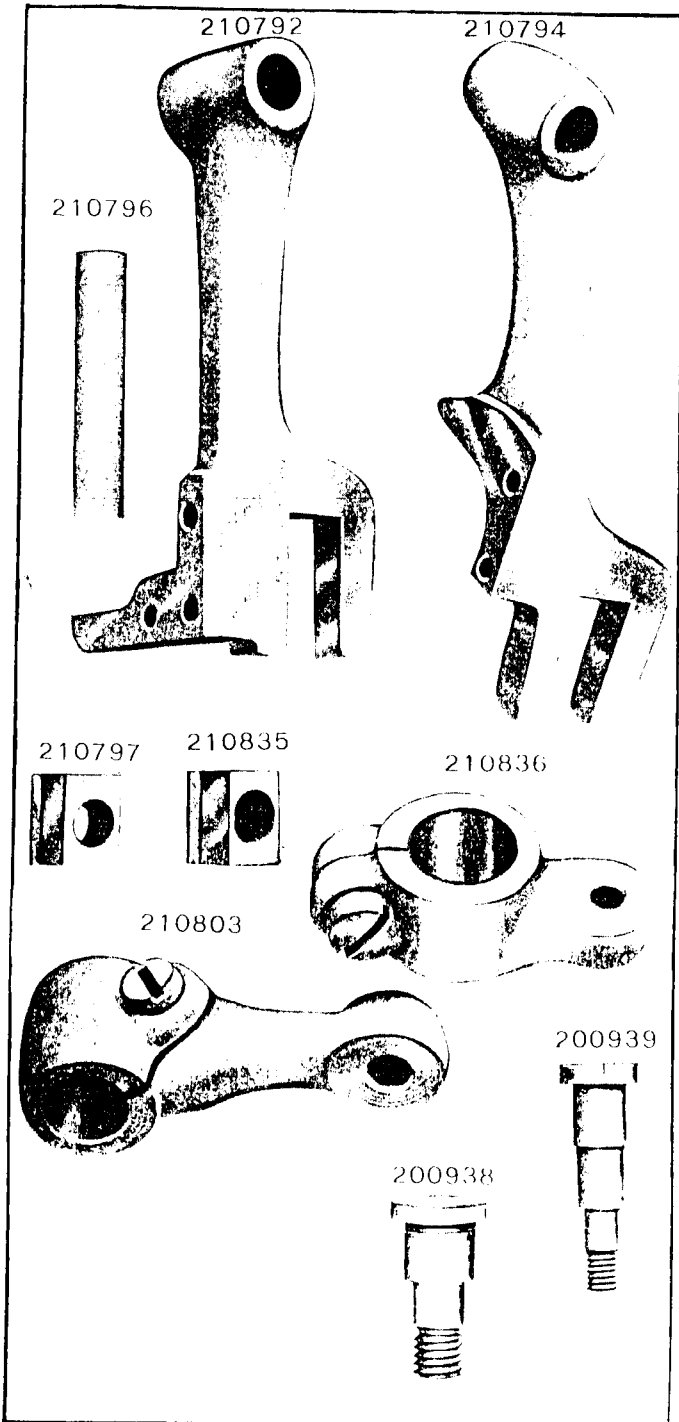


PLATE 10740 -ONE-HALF SIZE

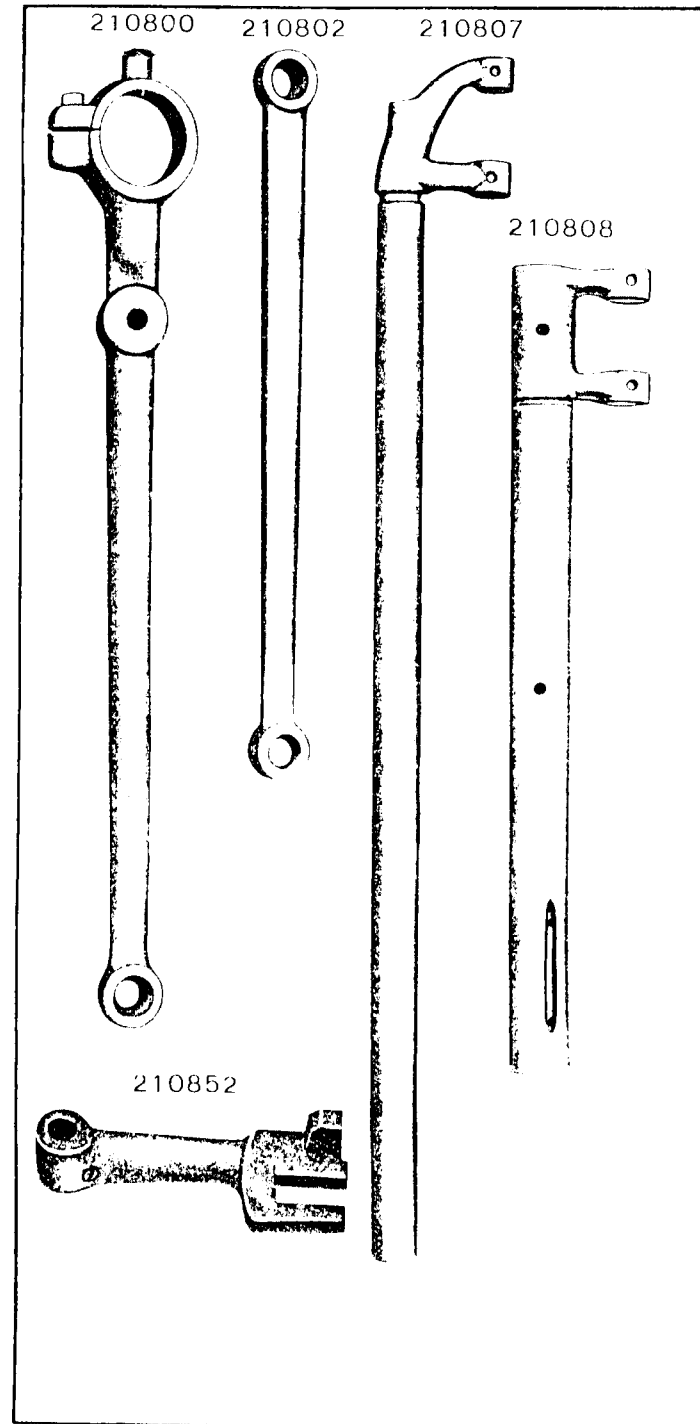


PLATE 10750 -ONE-HALF SIZE

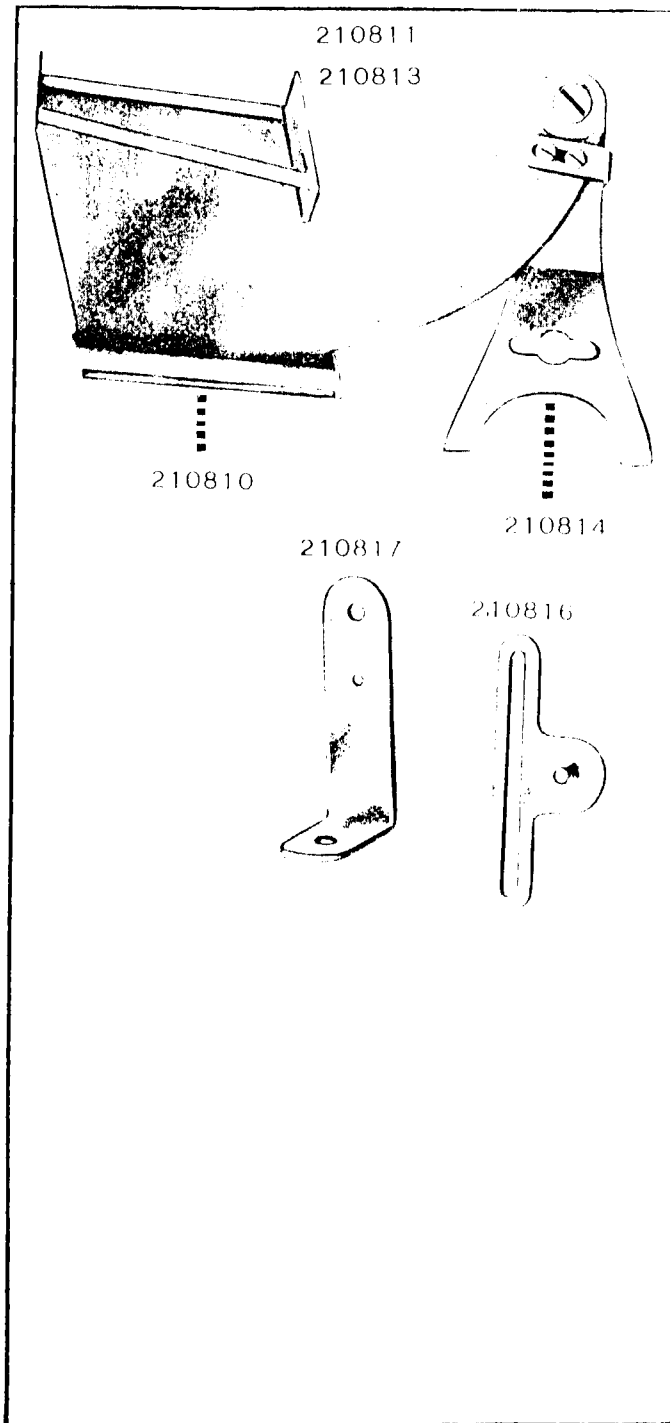


PLATE 10751 -ONE-HALF SIZE

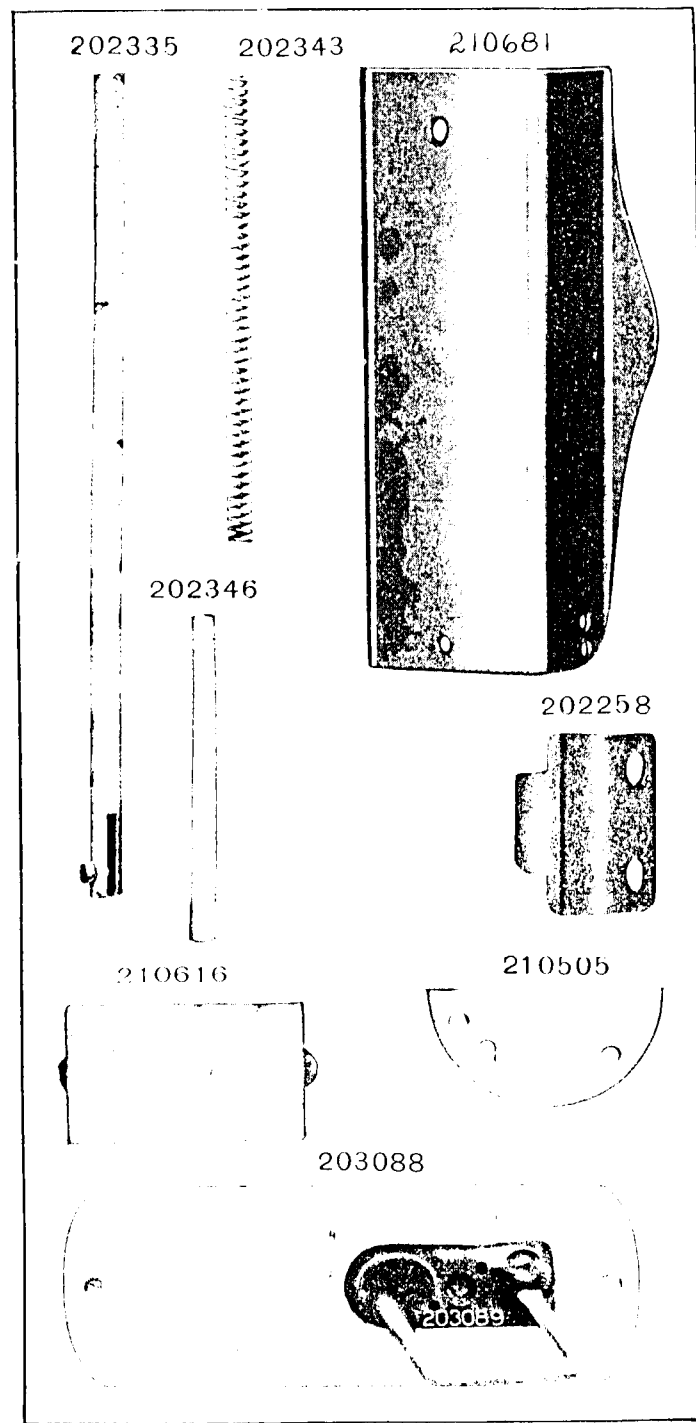


PLATE 10752—ONE-HALF SIZE

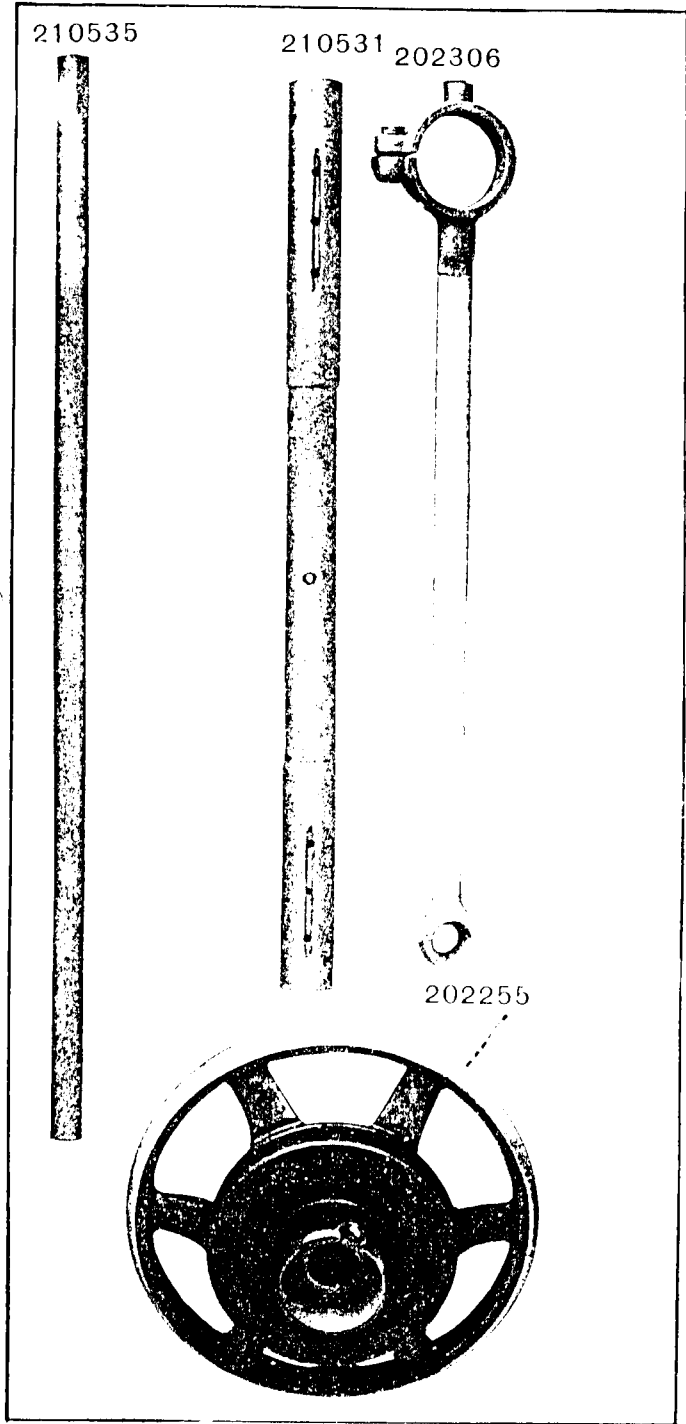


PLATE 10753—ONE-HALF SIZE

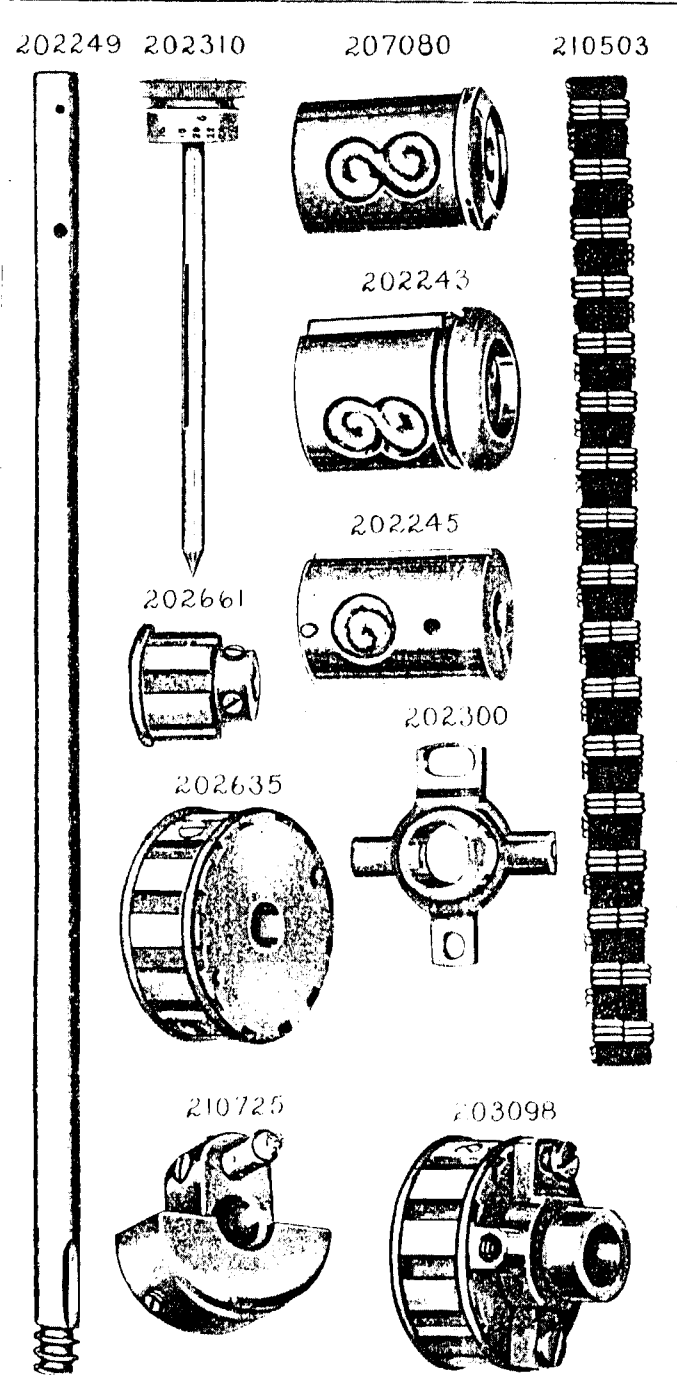


PLATE 10755—FULL SIZE

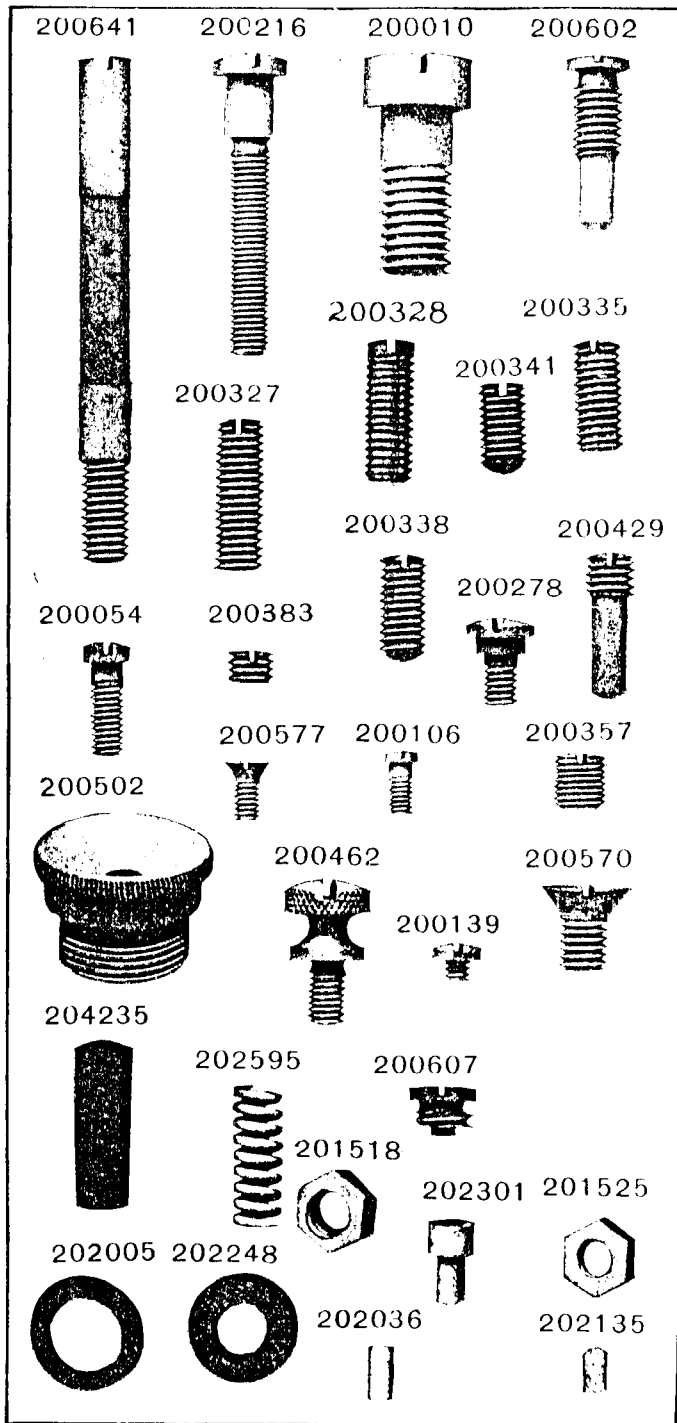


PLATE 10756—FULL SIZE

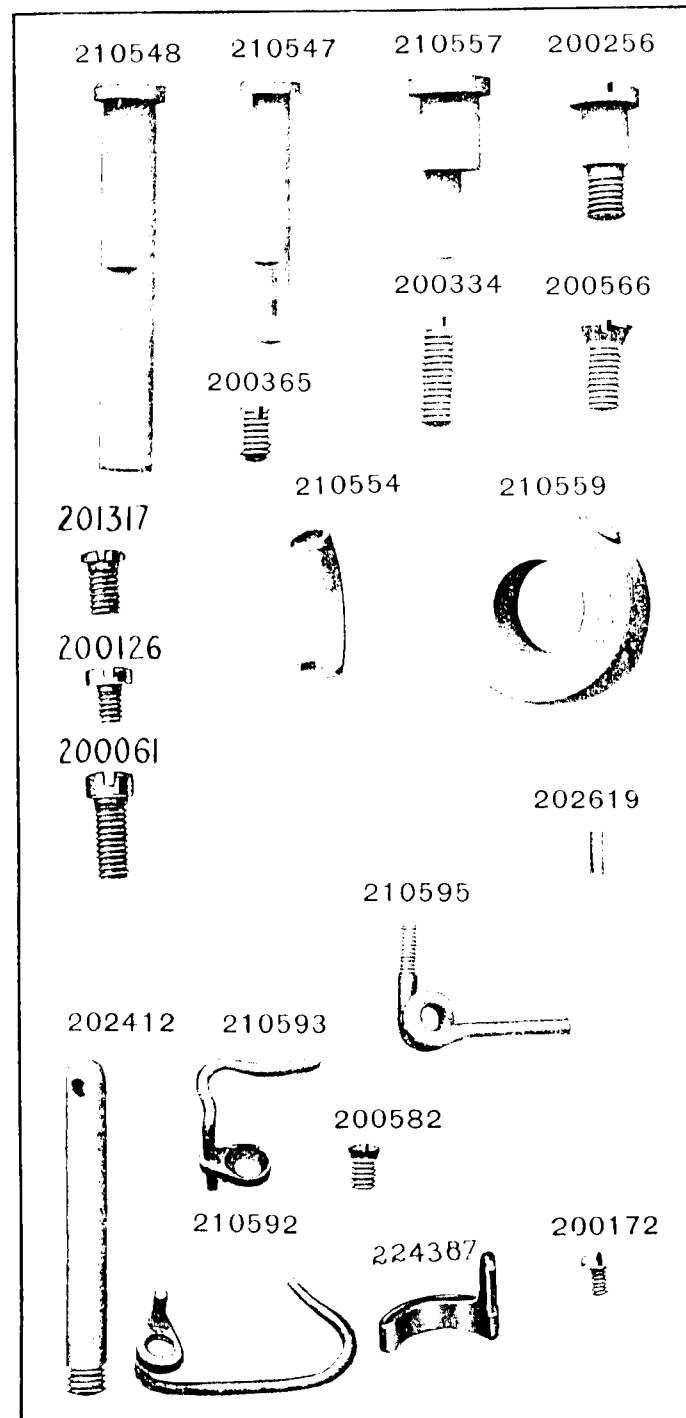


PLATE 10757—FULL SIZE

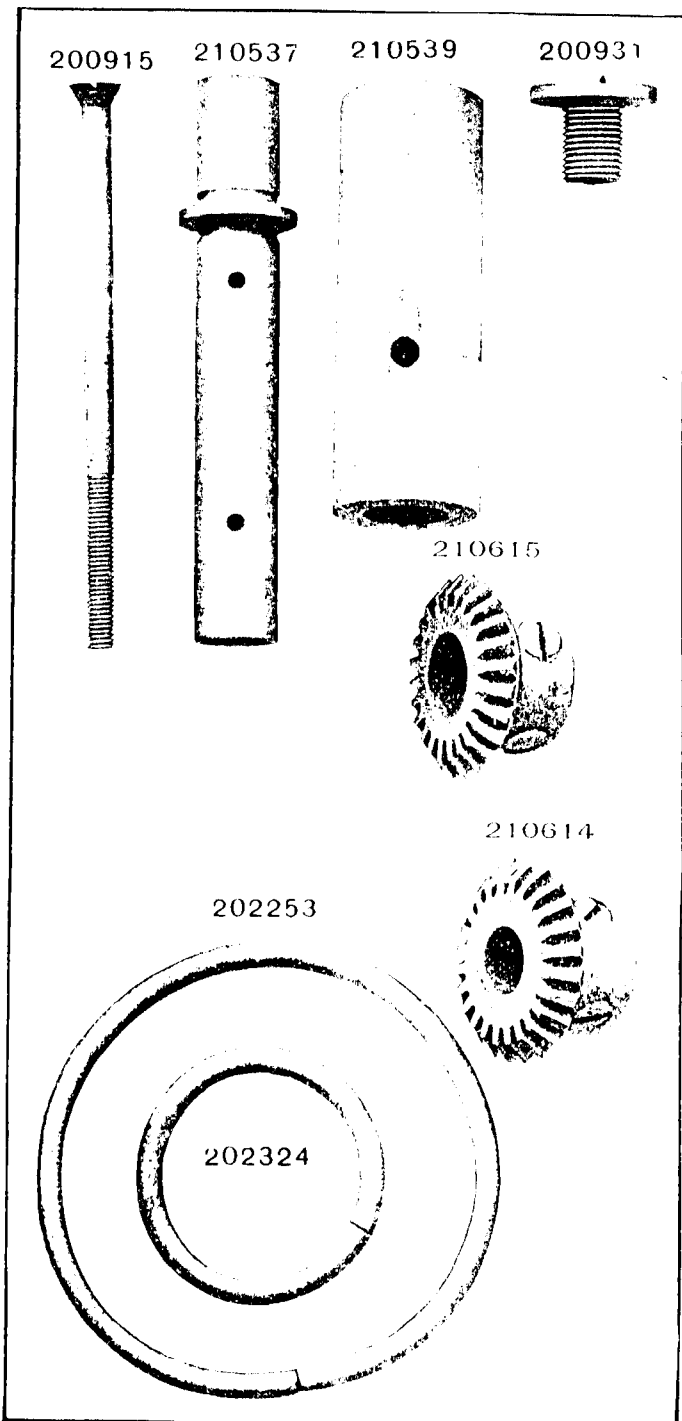


PLATE 10761—FULL SIZE

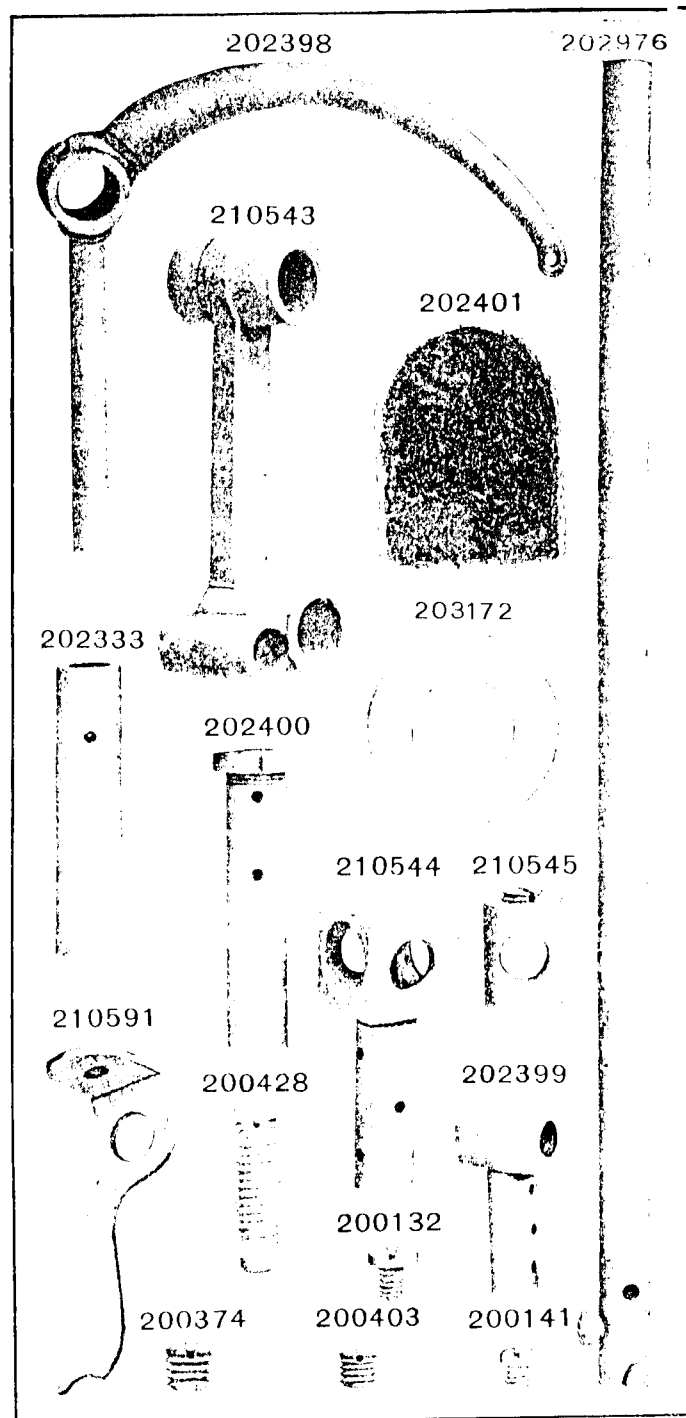


PLATE 10762—FULL SIZE

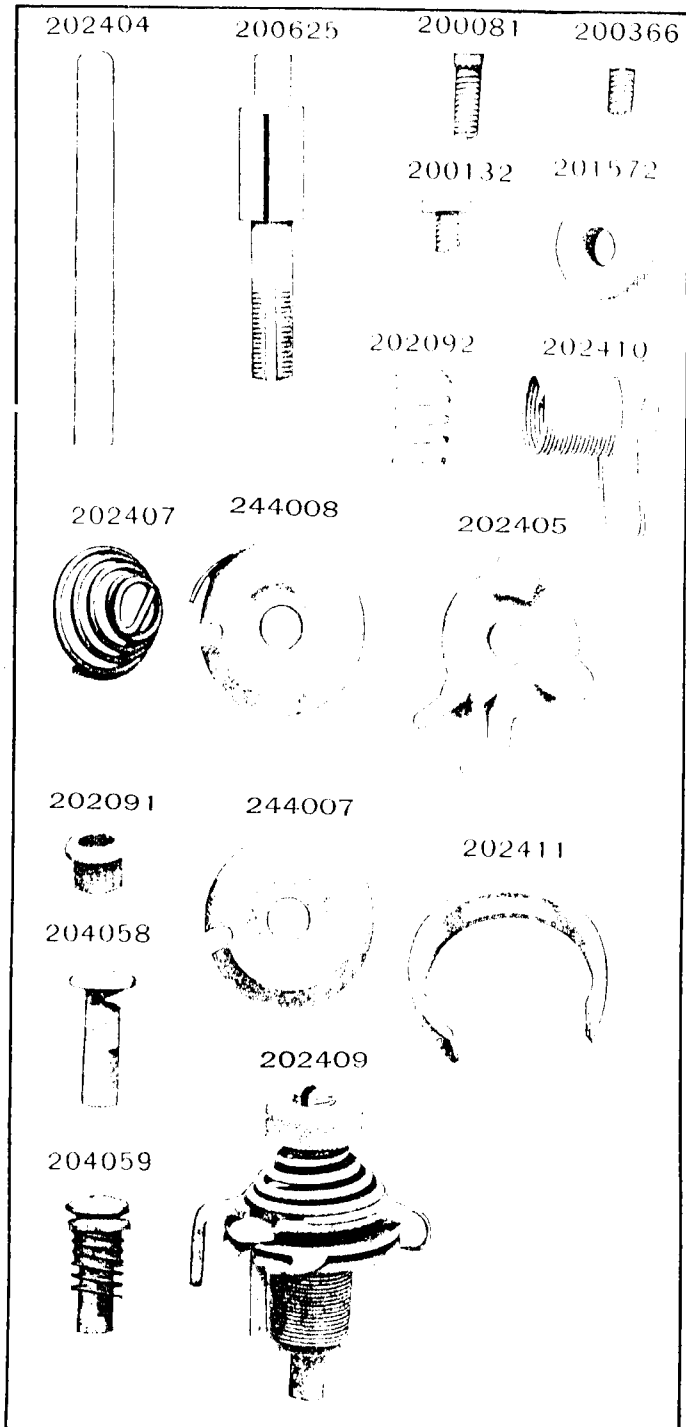


PLATE 10782—ONE-FOURTH SIZE

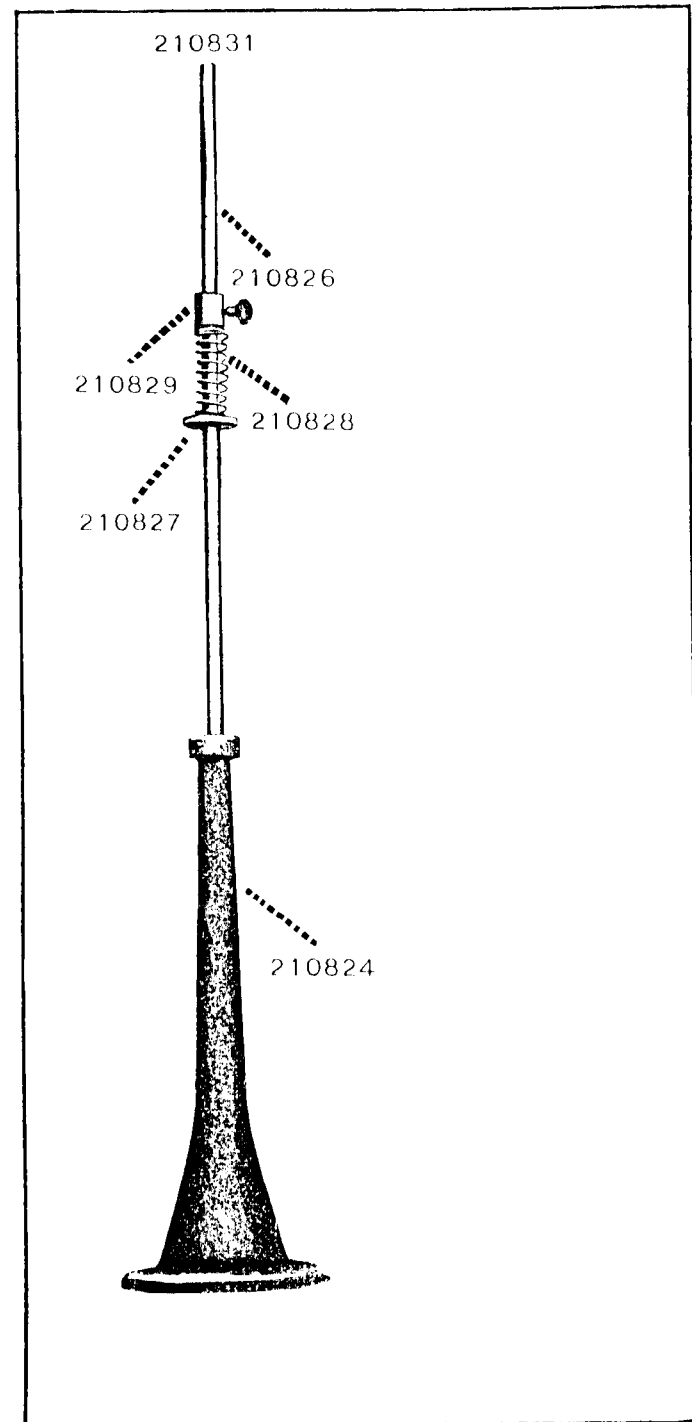
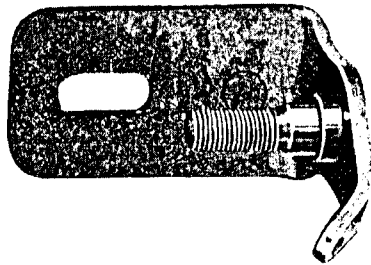




PLATE 10881—FULL SIZE

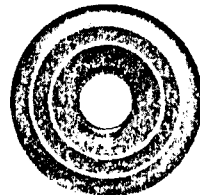
225461



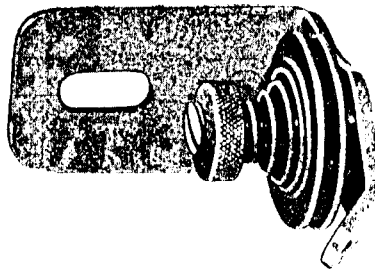
200082 202104



2102



225462



202407



201499

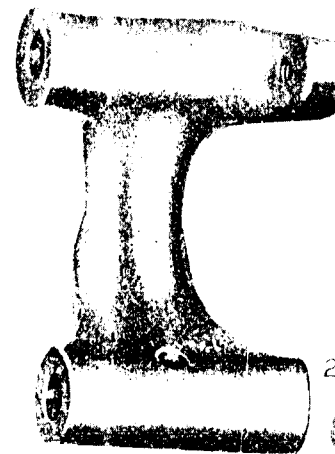


201572

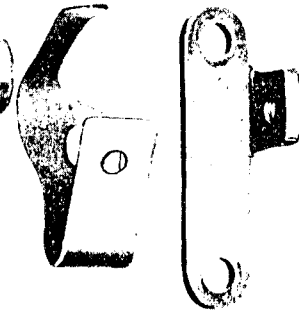


PLATE 10884—FULL SIZE

225453



225444 202478



228026



225458



225460



225454



200299



225438



200056



225459



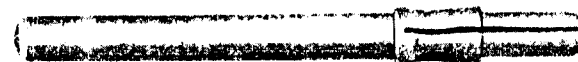
200105



225456



225381



225455



PLATE 10885—ONE-FOURTH SIZE

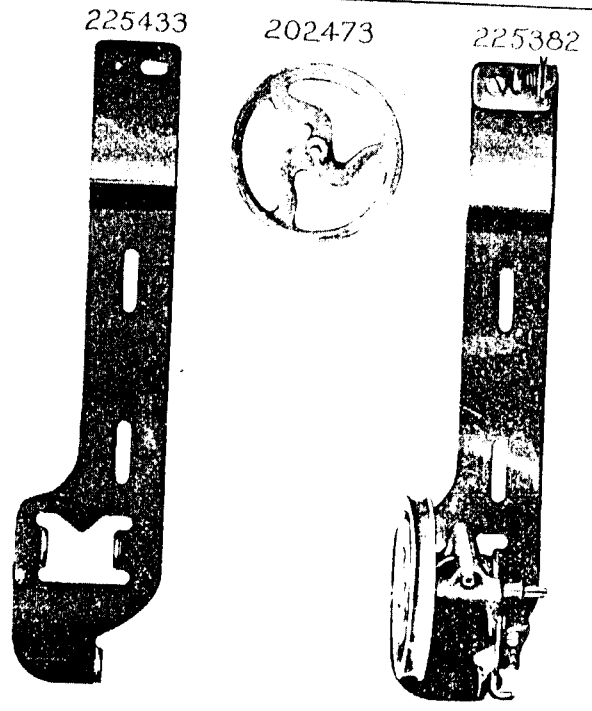


PLATE 10957—ONE-HALF SIZE

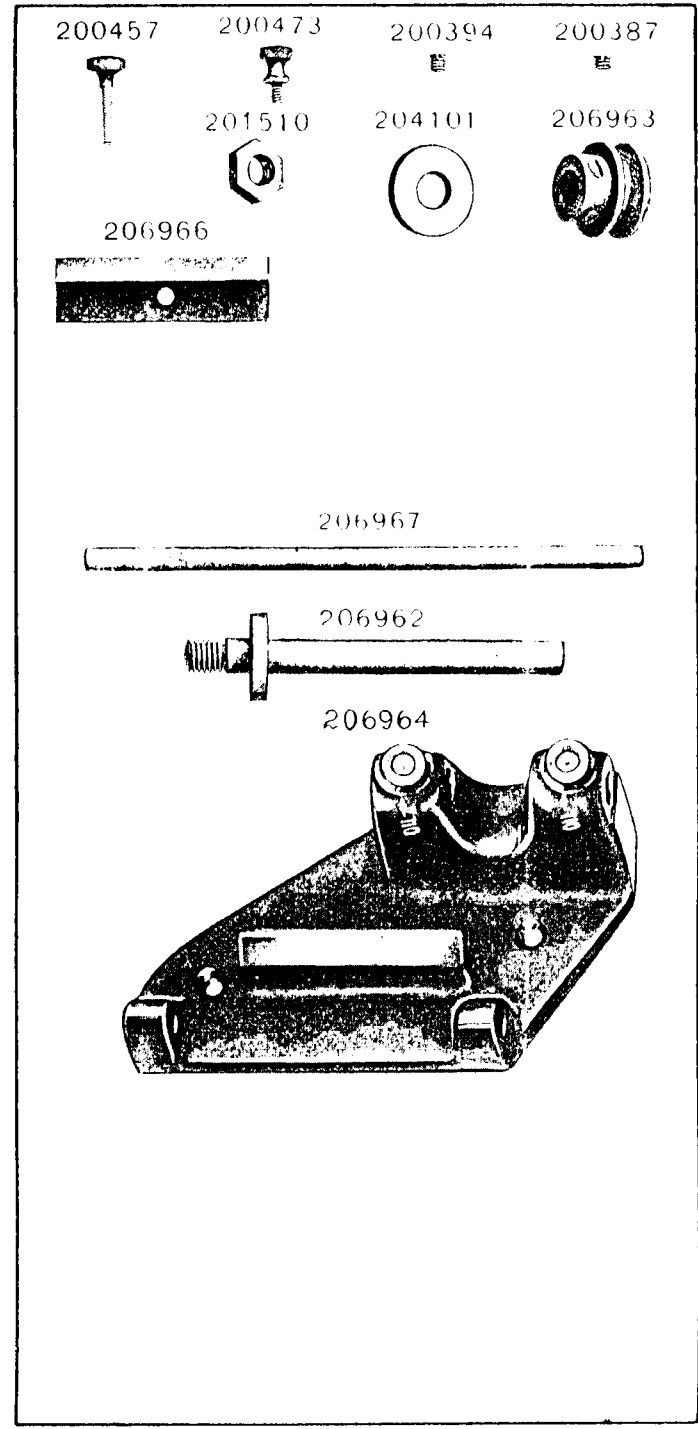


PLATE 12345—ONE-HALF SIZE

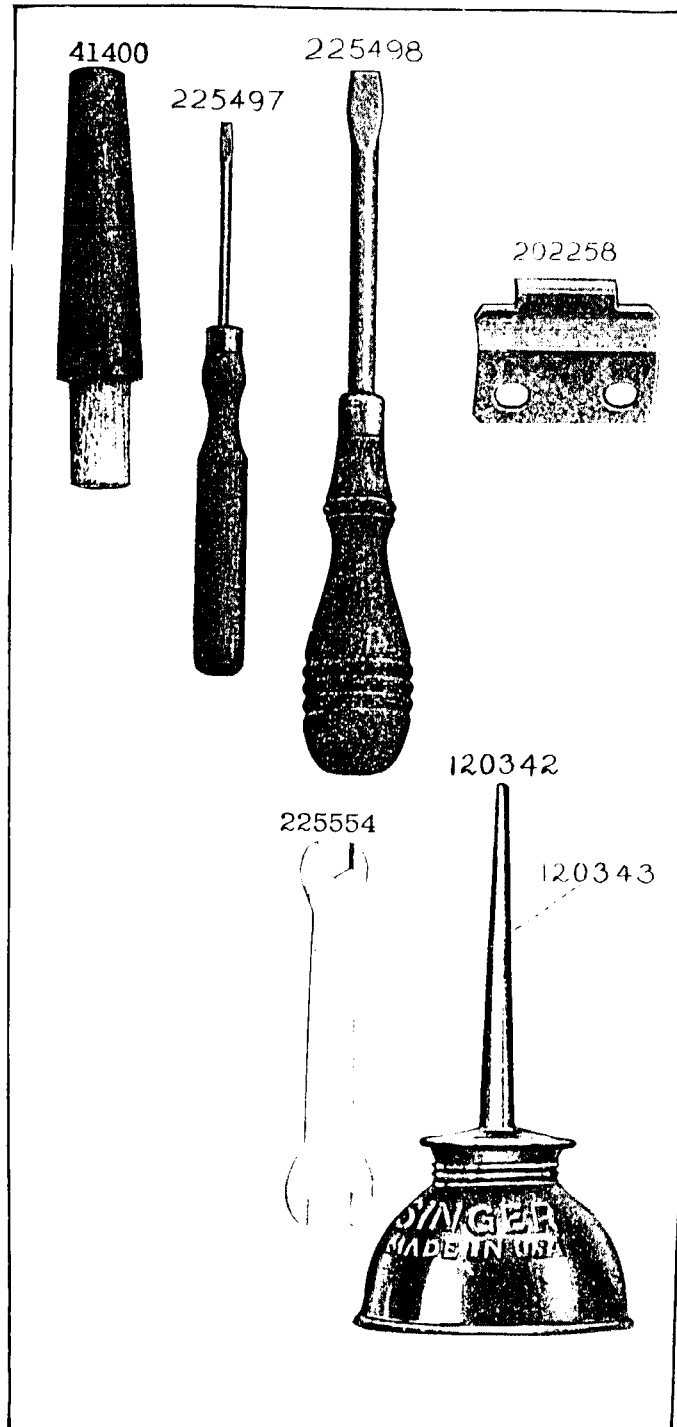


PLATE 13181—ONE-FOURTH SIZE

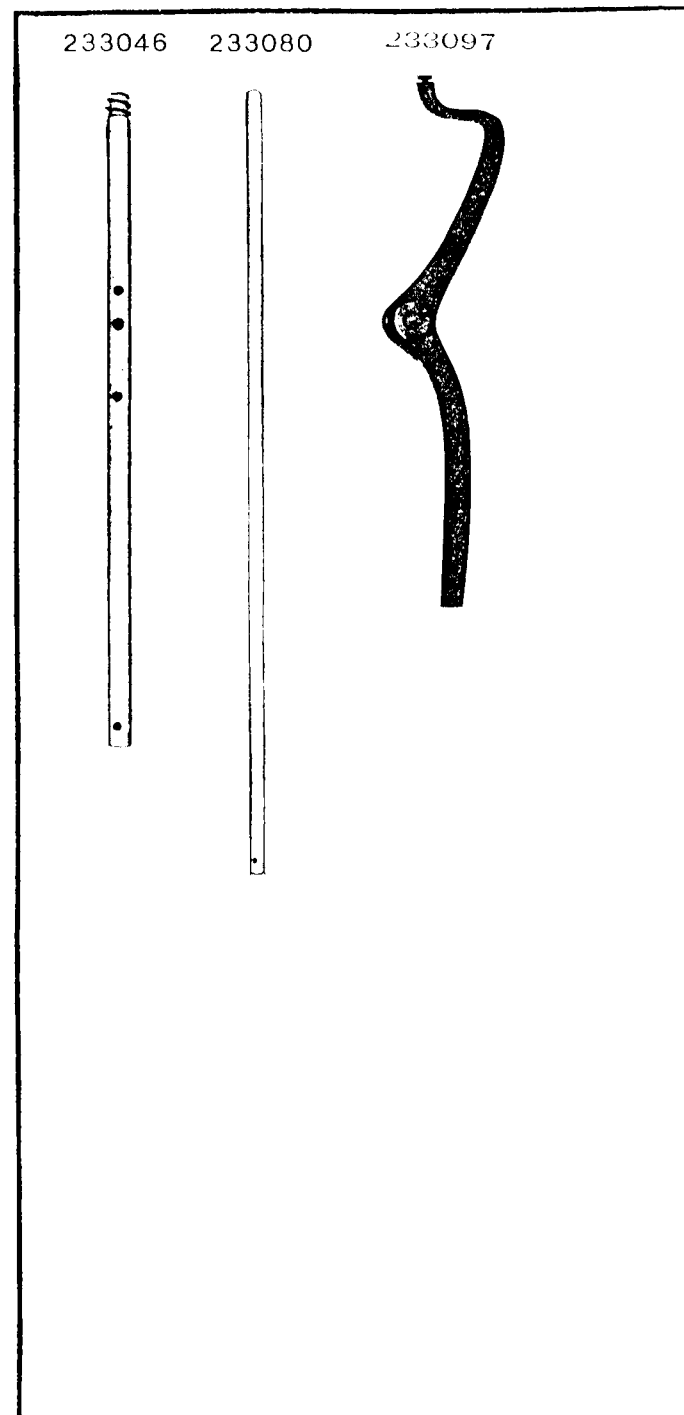


PLATE 13182-FULL SIZE

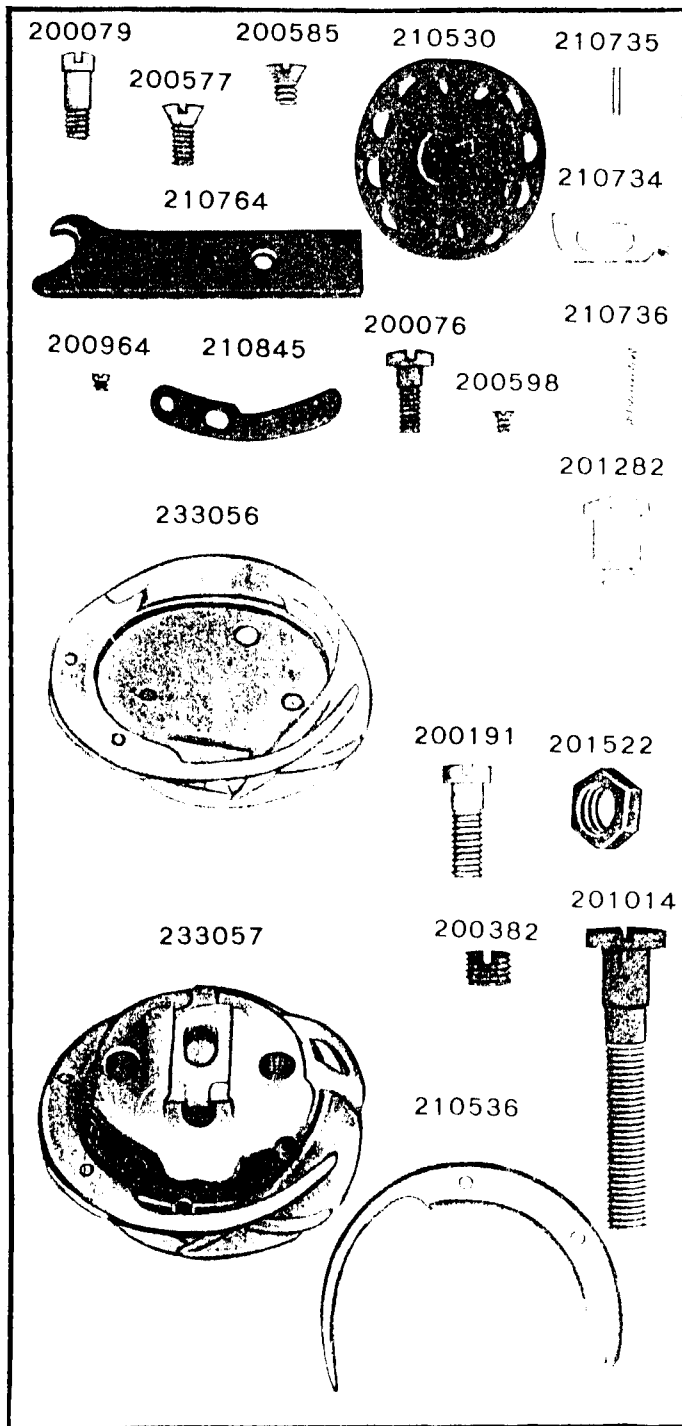


PLATE 13183-FULL SIZE

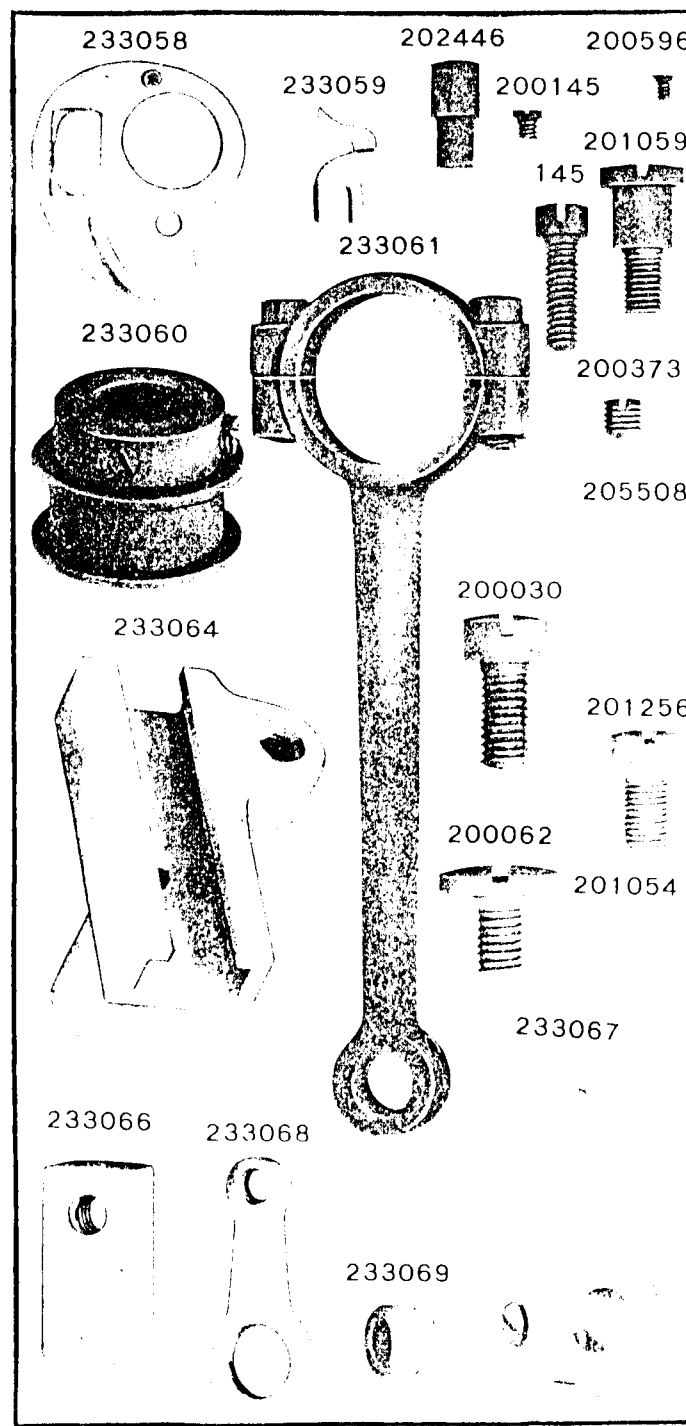


PLATE 13184—FULL SIZE

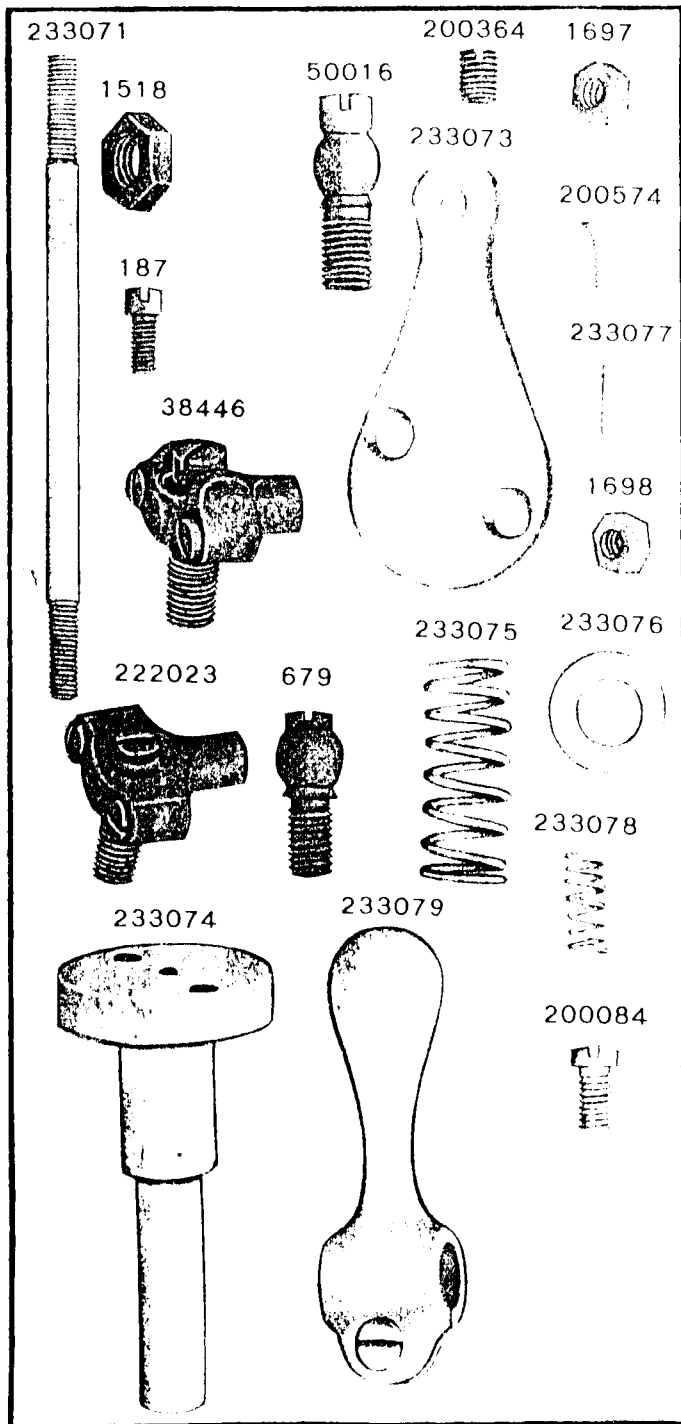


PLATE 13185—ONE-HALF SIZE

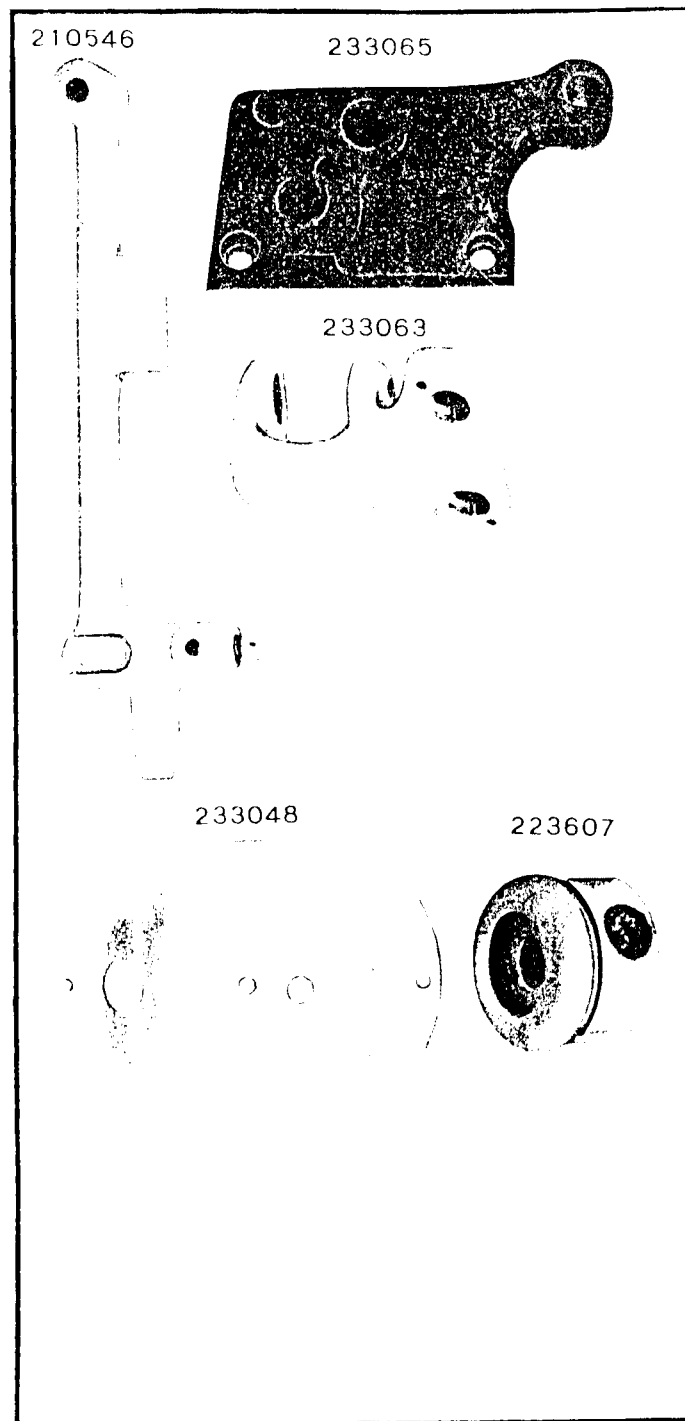


PLATE 13191-FULL SIZE

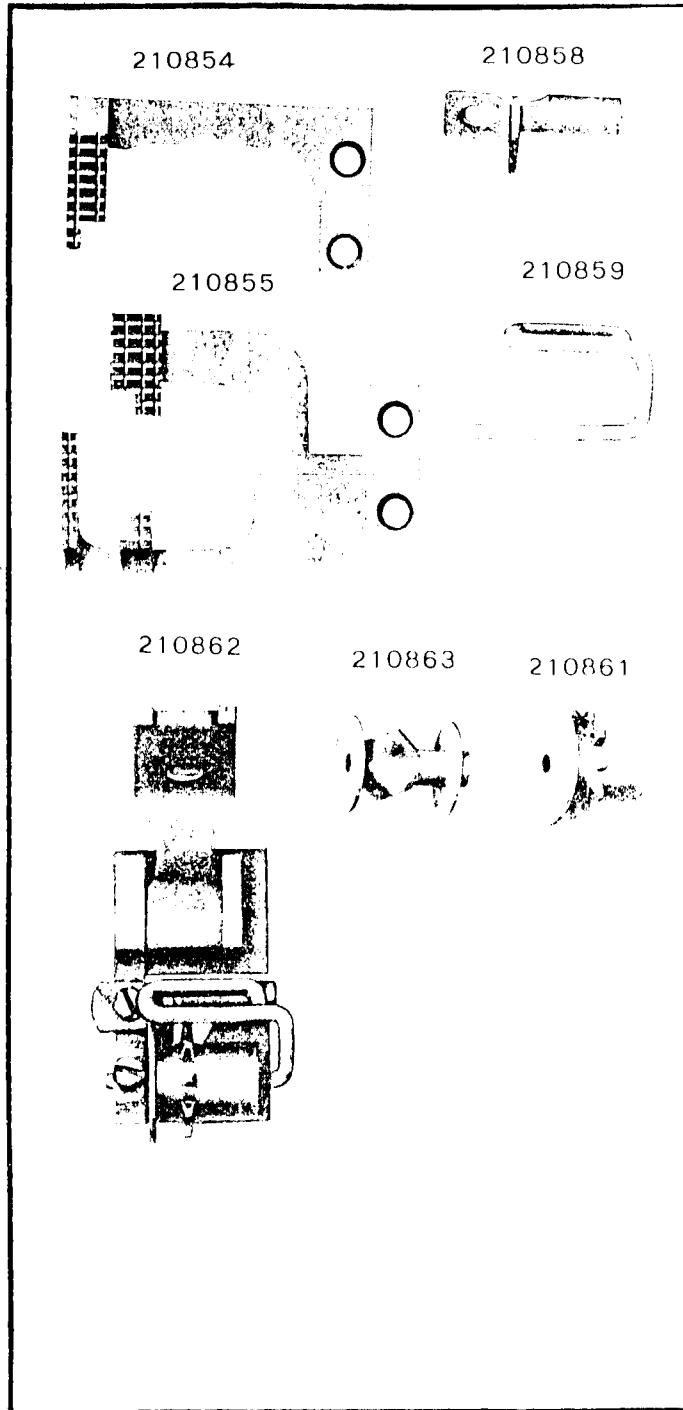


PLATE 13192-FULL SIZE

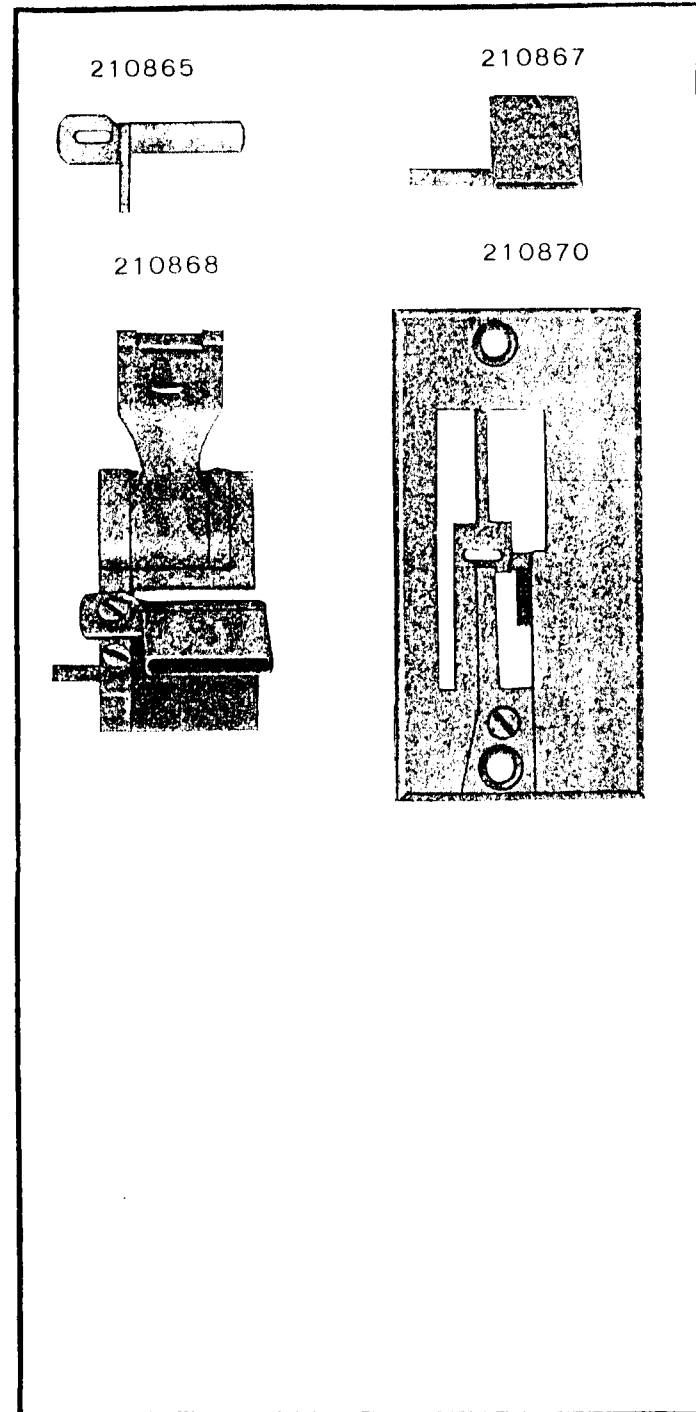


PLATE 13193-ONE-HALF SIZE

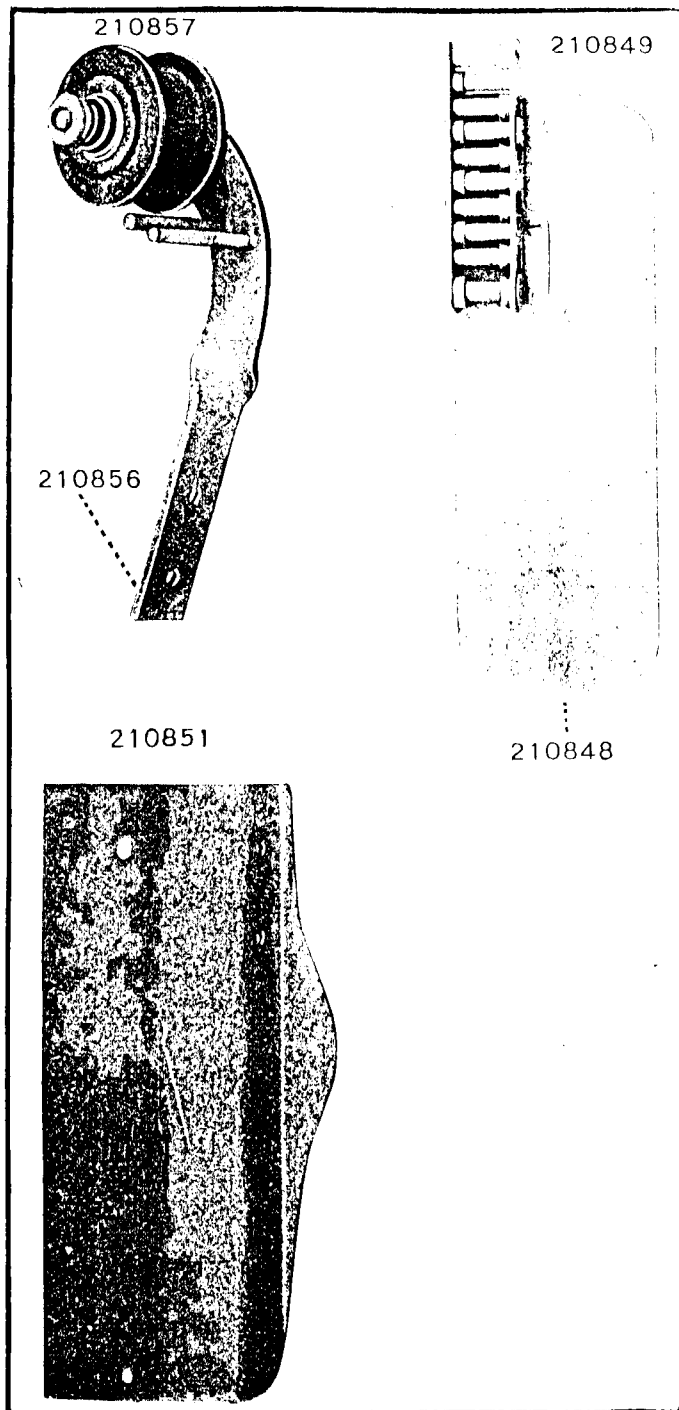


PLATE 13194-FULL SIZE

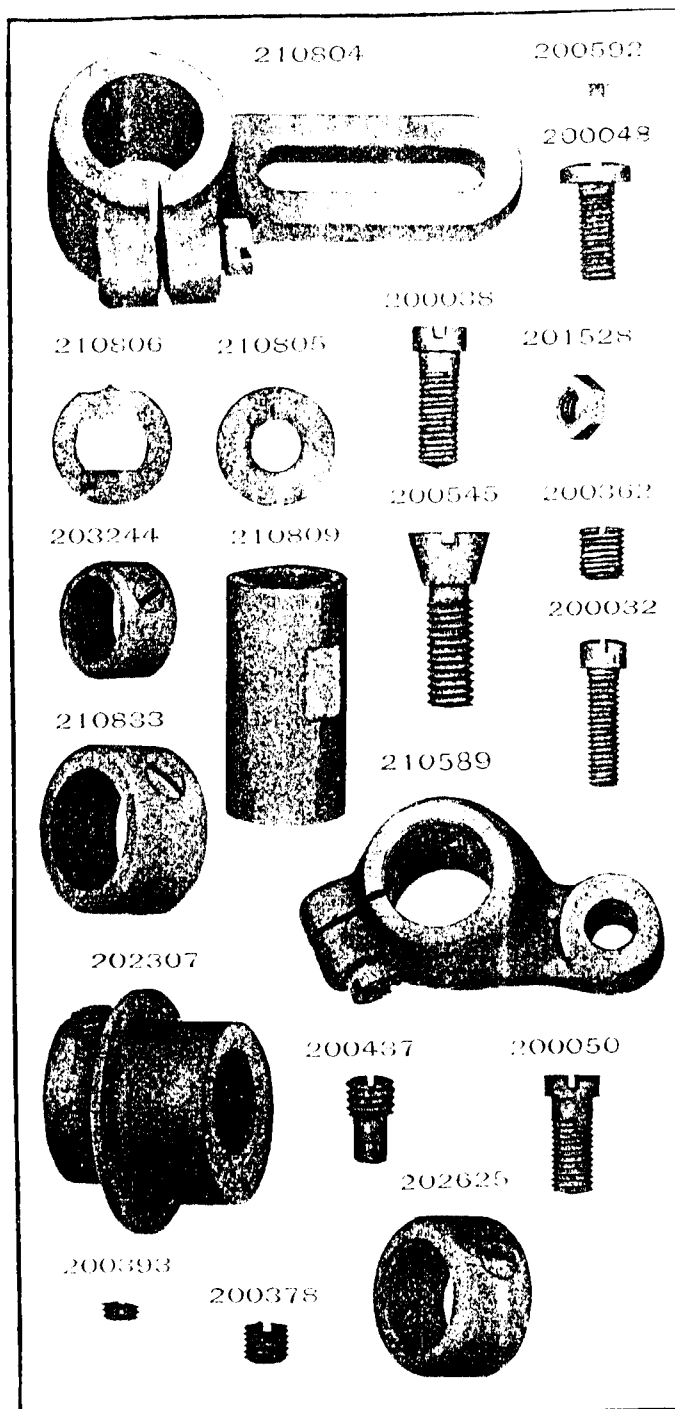


PLATE 13195—FULL SIZE

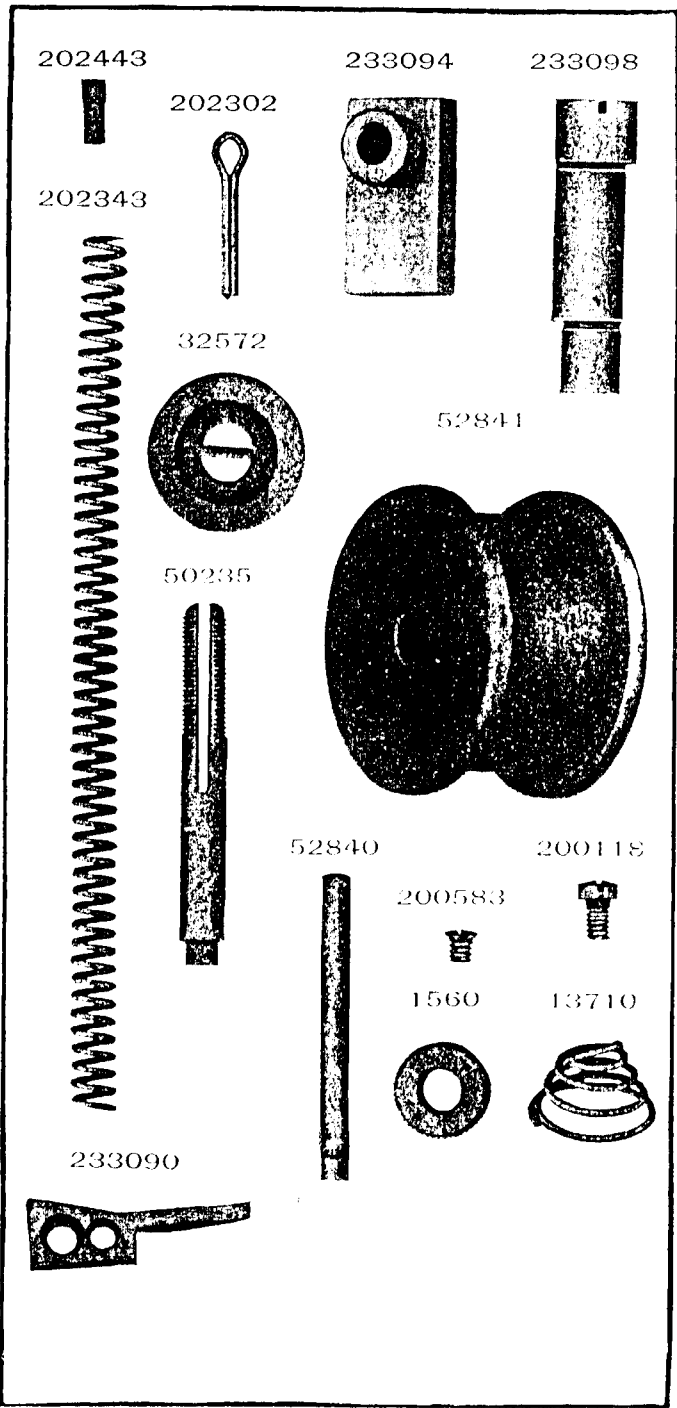


PLATE 13395—ONE-FOURTH SIZE

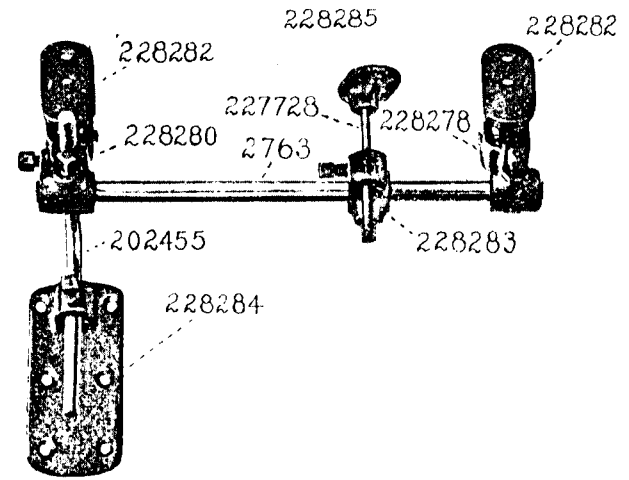
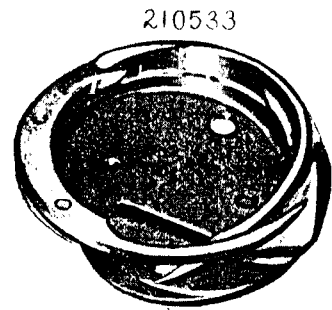
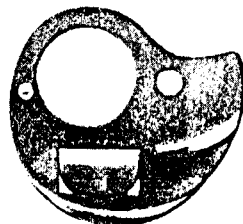




PLATE 15276—FULL SIZE



210533

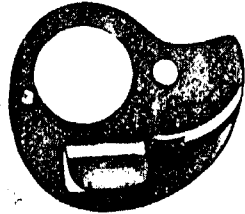
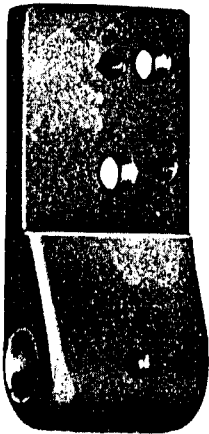


210541

233083



233081



233058

200262



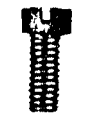
201059



201107



200061



233082



200051



175



225832



200113



200161



202355



200136



202602



200380

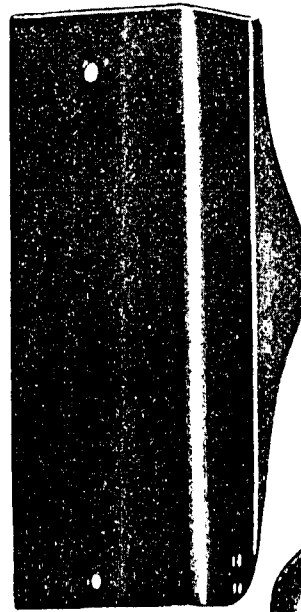


200387

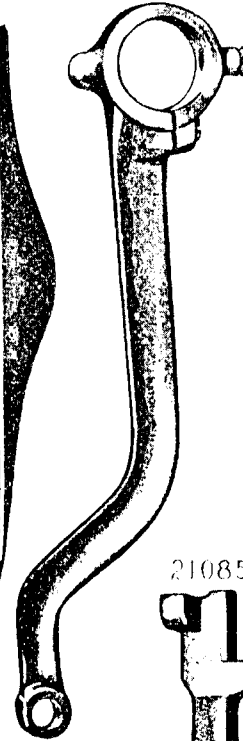


PLATE 15277—ONE-HALF SIZE

210661



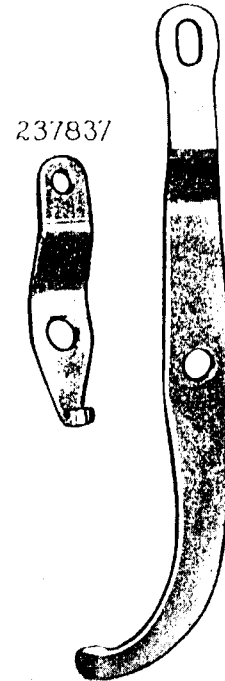
210556



202447



210875



210852



237837





PLATE 15280—FULL SIZE

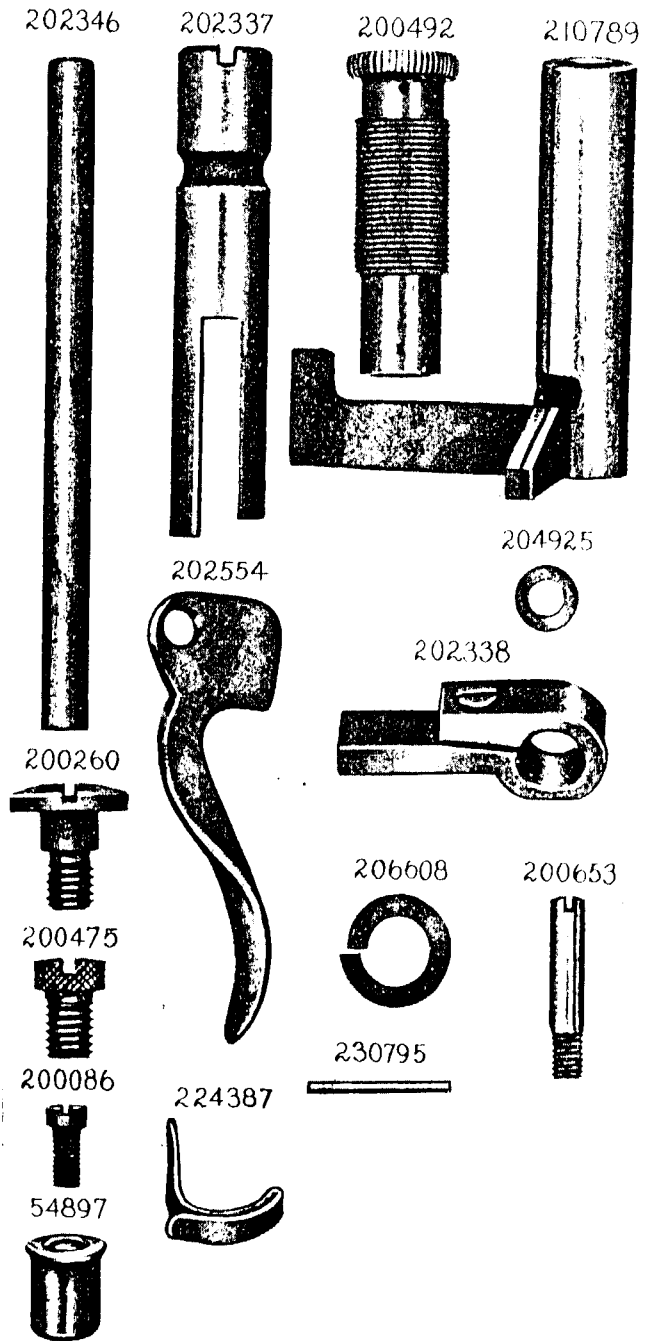


PLATE 15281—FULL SIZE

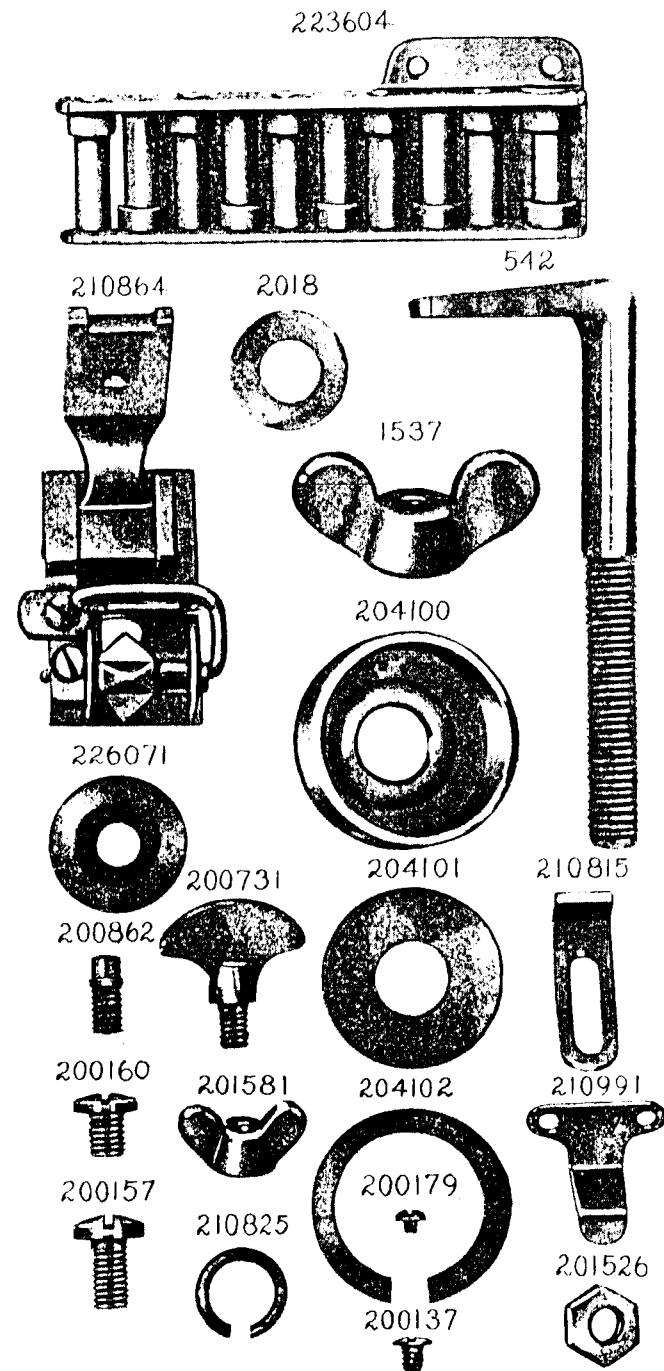


PLATE 15282—FULL SIZE

