

SINGER
107W8 to W11

LIST OF PARTS



MACHINES Nos. 107w8 to 107w11

THE SINGER MANUFACTURING COMPANY

INDEX

	PAGE
ACCESSORIES	49
BOBBIN WINDER	49
FEED DOGS	52
KNEE LIFTER	50
MACHINE No. 107w8	7
" " 107w9	17
" " 107w10	28
" " 107w11	38
NUMERICAL LIST OF PARTS	55
PRESSER FEET	53
THROAT PLATES	54
TREADLE	52

Instructions for Ordering

In ordering from this list, use **ONLY** the **PART** number in the **FIRST** column.

The number stamped on a Sewing Machine Part is the number of the **Single Part** only, except when the part includes Set Screws, Clamping Screws, Studs and Rollers Spun on, Small Wires riveted, or Parts soldered together, etc., which it is necessary to furnish in combination.

Every combination of parts sent out has its specific number which, although not stamped on Parts (except in above cases) must be used when ordering the combination.

Each number always indicates the **SAME PART** in whatever list it appears, or for whatever Machine.

The letters after some of the numbers indicate the style of finish only, as follows:

- A. Hardened, Polished and Plated.
- B. Polished and Plated.
- C. Hardened only.
- D. Polished only.
- E. Soft, not polished.
- F. Hardened and Polished.
- H. Blued.

These letters **MUST BE USED** when they appear in the is and **AFTER** the number, as in the list.

In this series

- 200001 to 201500 are Screw Numbers.
- 201501 to 201800 are Nut Numbers.
- 201801 to 202000 are Roller Numbers.
- 202001 and upward are numbers of Machine Parts.

The figures in the second column refer only to the plate in which the illustration of the part is shown and are **NOT TO BE USED** in ordering.

Two or more numbers over a cut indicate that the difference between such parts is not visible in an illustration.

Parts marked with an asterisk (*) are furnished only when repairs are made at the factory.

LIST OF PARTS COMPLETE

FOR

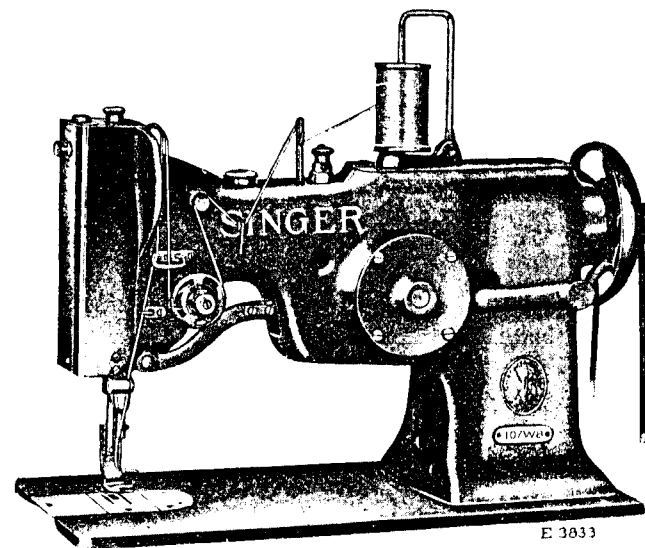

MACHINE No. 107w8

HIGH SPEED ZIGZAG

For Stitching Leather Sweat Bands to Soft Caps

No.	Plate	Name
*235201	---	Arm
203087	10751	" Cap
200278H	10755	" " Screw
202248	10755	" " " Washer
203089	10751	" " Spool Holder Base
203090	---	" " " " " 203089 with 200079H and 204296
200585H	13197	Arm Cap Spool Holder Base Screw
204296	10751	" " " " Wire
200079H	13197	" " " " " Hinge Screw
203088	10751	Arm Cap and Spool Holder complete, Nos. 203087, 203090 and two 200585H
204235	10755	Arm Position Pin (2)
200010E	10755	" Screw (3)

No.	Plate	Name
200378c	10760	Hook Driving Bevel Pinion Shaft Belt Pulley Set Screw
202324	10757	Hook Driving Bevel Pinion Shaft Belt Pulley Spring Flange
210536	13174	Hook Gib
200596F	13174	" " Screw
203101	-----	" Oil Wick
200915F	10757	" Position Screw
210537	10757	" Shaft (hollow)
210615	10757	" " Bevel Gear (steel), 24 teeth, with two 200382c
200382c	13197	Hook Shaft Bevel Gear Set Screw
210539	10757	" " Bushing
210621	-----	" " " 210539 with 200931F and 210537
200335c	10755	Hook Shaft Bushing Set Screw ...
200363c	10736	" " " " " "
202355	10759	" " " " " " Pack- ing (brass)
200931F	10757	Hook Shaft Position Screw
210541	13174	" Washer Needle Guard
200145H	13174	" " " " Screw..
202445	10958	Knee Lifter Connection Lever with 202446
202786	-----	Knee Lifter Connection Lever 202445 with 200224H, 200262H, 202447 and 202449
200224H	10759	Knee Lifter Connection Lever Hinge Screw
202447	10958	Knee Lifter Connection Lever Lift- ing Rod with 202302
202302	13178	Knee Lifter Connection Lever Lift- ing Rod Cotter Pin
202446	13197	Knee Lifter Connection Lever Pin
202449	14159	" " Lifting Lever
200262H	10759	" " " " Hinge Screw
202976	10761	Needle Bar with 200141F
210543	10761	" " Connecting Link
202333	10761	" " " " Stud with 202254
202254	-----	Needle Bar Connecting Link Stud Oil Packing (wick)
200383c	10755	Needle Bar Connecting Link Stud Set Screw
200374c	10761	Needle Bar Connecting Link Stud Set Screw
210544	10761	Needle Bar Connecting Stud with 202277

No.	Plate	Name
210585	-----	Needle Bar Connecting Stud 210544 with 210545
202277	-----	Needle Bar Connecting Stud Oil Packing (wick)
210545	10761	Needle Bar Connecting Stud Swiv- el with 200387c
210725	10753	Needle Bar Crank with 200335c, 200374c, 200383c, 200428c and 202333
203172	10761	Needle Bar Crank Friction Washer
200428c	10761	" " " Position Screw ..
200335c	10755	" " " Set Screw
210726	-----	Needle Bar Crank complete, Nos. 202398 to 202400, 210543, 210585 and 210725
210546	14160	Needle Bar Frame with 200070c ..
210542	-----	" " " 210546 with 202976 ..
210547	10756	" " " Guide Stud
200334c	10756	" " " " " " Set Screw
210548	10756	Needle Bar Frame Hinge Stud ...
200334c	10756	" " " " " " Set Screw
235208	14160	Needle Bar Frame Pitman
235209	14160	" " " " Fork
200089c	14158	" " " " " " Screw
207125	14158	" " " " " " Washer
202277	-----	Needle Bar Frame Pitman Oil Packing (wick)
205975	14158	Needle Bar Frame Pitman Spring
235210	14160	" " " " " " Bracket
200247F	14158	Needle Bar Frame Pitman Spring Bracket Hinge Screw
201523E	14158	Needle Bar Frame Pitman Spring Bracket Hinge Screw Nut
235211	14158	Needle Bar Frame Pitman Spring Collar
201471B	14158	Needle Bar Frame Pitman Spring Regulating Thumb Screw
201673D	14158	Needle Bar Frame Pitman Spring Regulating Thumb Screw Check Nut
235212	14158	Needle Bar Frame Pitman Stud ..
200070c	13197	" " " " " " Set Screw

No.	Plate	Name
235213	—	Needle Bar Frame Pitman complete, Nos. 200247F, 201528E, 202277, 207125, 210707, 210712, 235208 to 235210, two each 200089c, 200919c and 201522E ...
200387c	14158	Needle Bar Set Screw
200141F	10761	" Set Screw
235214	14158	" Vibrator Cam
200031c	14158	" " " Screw
235215	14160	" " " Shaft
210551	14160	" " " " Bearing and Cover
200566d	10756	Needle Vibrator Cam Shaft Bearing and Cover Screw (4)
210559	10756	Needle Vibrator Cam Shaft Collar with two 200378c
200378c	10760	Needle Vibrator Cam Shaft Collar Set Screw
210712	13174	Needle Vibrator Crank with 200378c and 200917c
210707	13174	Needle Vibrator Crank Link
200919c	14158	" " " " Hinge Screw
201522E	13197	Needle Vibrator Crank Link Hinge Screw Nut
210723	14158	Needle Vibrator Crank Link Oil Tube
200917c	14158	Needle Vibrator Crank Position Screw
200378c	10760	Needle Vibrator Crank Set Screw
210711	13174	" " " Shaft
235216	14160	" " Gear (spiral) with 200382c and 201472c
235217	—	Needle Vibrator Gear 235216 with 200031c and 235214
200382c	13197	Needle Vibrator Gear Set Screw ..
201472c	14158	" " " " " " ..
203172	10761	" " " Thrust Washer
235218	14160	" " Pinion (spiral) with two 200382c
200382c	13197	Needle Vibrator Pinion Set Screw
210770	14160	" " Regulating Lever with 200378c and 200917c
235219	14160	Needle Vibrator Regulating Lever Position Bracket (indexed) with 200378c and 200917c
200917c	14158	Needle Vibrator Regulating Lever Position Bracket Position Screw
200378c	10760	Needle Vibrator Regulating Lever Position Bracket Set Screw

No.	Plate	Name
200917c	14158	Needle Vibrator Regulating Lever Position Screw
200378c	10760	Needle Vibrator Regulating Lever Set Screw
210772	14158	Needle Vibrator Regulating Lever Slide
201556d	14158	Needle Vibrator Regulating Lever Slide Thumb Nut
202335	10751	Presser Bar (hollow) with 200074F
207072	10759	" " Bushing
200352c	10759	" " " Set Screw
202554	10759	" " Lifter
200653c	10759	" " " Hinge Screw ..
210561	10759	" " Lifting Releasing Lever Bracket
200260d	10759	Presser Bar Lifting Releasing Lever Bracket Guide Screw
202342	10759	Presser Bar Lifting Releasing Lever Bracket Spring (spiral)
202337	10759	Presser Bar Position Guide
202338	10759	" " " " Lever with 200086F
200086F	10759	Presser Bar Position Guide Lever Pinch Screw
200352c	10759	Presser Bar Position Guide Set Screw
202378	10748	Presser Bar Spring (heavy)
202346	10751	" " " Stop Rod
200492B	10759	" " Thumb Screw (pressure regulating)
200475B	10759	Presser Bar Thumb Screw Thumb Set Screw
202355	10759	Presser Bar Thumb Screw Thumb Set Screw Packing (brass)
235220	14164	Presser Foot
200074F	10759	" " Screw
202398	10761	Take-up Lever
202399	10761	" " Driving Stud with 202277
202277	—	Take-up Lever Driving Stud Oil Packing (wick)
202400	10761	Take-up Lever Hinge Stud with 202423
202423	—	Take-up Lever Hinge Stud Oil Packing (wick)
200383c	10755	Take-up Lever Hinge Stud Set Screw
202401	10761	Take-up Lever Oiling Felt
200132E	10761	" " " " Screw..

No.	Plate	Name
202402	10762	Tension Disc (back)
210967	14158	" " (front)
202404	10762	" Release Plunger
235221	14158	" " Washer
202407	10881	" Spring
200625F	10762	" Stud with 204925
200061C	—	" " Set Screw
204925	13197	" " Washer
201572R	10881	" Thumb Nut
235222	—	Tension complete, Nos. 200625F, 201572R, 202402, 202407, 202682, 210967 and 235221
202682	14161	Thread Controller Spring
202411	10762	" " " Stop
200132E	10761	" " " " Screw
210954	14161	" Guide (lower)
210955	14161	" " (upper)
210595	14161	" " (on side of Arm)
202412	10756	" " (on top of Arm)
200582H	14161	" " Screw (3)
210683	—	" Retainer Bracket with 200397H
200137H	13178	" " " Screw
210684	13178	Thread Retainer Bracket complete, Nos. 210683, 210957, 210958, 210992 and 210993
210960	14161	Thread Retainer Disc
210961	14161	" " Plunger
210962	14161	" " " Spring
210993	13178	" " Sleeve
210963	14161	" " Socket
200389C	13178	" " " Set Screw
210992	13178	" " Spring
210957	13178	" " Stud
210958	13178	" " " Collar
200397H	13178	" " " Set Screw
210600	14165	Throat Plate, 53 needle hole, for needle sizes 12 and 13
200577H	10755	Throat Plate Screw (2)

LIST OF PARTS COMPLETE

FOR

MACHINE No. 107w9

HIGH SPEED ZIGZAG

For Hat Sweat Work

No.	Plate	Name
*235201	—	Arm
203087	10751	" Cap
200278H	10755	" " Screw
202248	10755	" " " Washer
203089	10751	" " Spool Holder Base
203090	—	" " " " " 203089 with 200079H and 204296
200585H	13197	Arm Cap Spool Holder Base Screw
204296	10751	" " " " Wire
200079H	13197	" " " " " Hinge Screw
203088	10751	Arm Cap and Spool Holder com- plete, Nos. 203087, 203090 and two 200585H
204235	10755	Arm Position Pin (2)
200010E	10755	" Screw (3)
202005	10755	" " Washer (3)
202249	10753	" Shaft with 200357E and 203100
202243	10753	" " Bushing (back) with 202244
202244	—	Arm Shaft Bushing (back) Oil Packing (wick)
200338C	10755	Arm Shaft Bushing (back) Set Screw
202245	10753	Arm Shaft Bushing (front) with 202036 and 202260
202260	—	Arm Shaft Bushing (front) Oil Packing (wick)
200502B	10755	Arm Shaft Bushing (front) Oil Packing Thumb Screw
202036	10755	Arm Shaft Bushing (front) Posi- tion Pin
200341C	10755	Arm Shaft Bushing (front) Set Screw
210503	10753	Arm Shaft Connection Belt
202635	10753	" " " " Pulley with 200327C, 200602E and two 202253

No.	Plate	Name
200602E	10755	Arm Shaft Connection Belt Pulley Position Screw
200327C	10755	Arm Shaft Connection Belt Pulley Set Screw
202253	10757	Arm Shaft Connection Belt Pulley Spring Flange
203100	----	Arm Shaft Oil Packing (wick)
200357E	10755	" " " " Stop Screw ..
202255	10752	Balance Wheel (belt groove 2 1/2 in. diam.) with 200328C and 200335C
200328C	10755	Balance Wheel Position Screw ..
200335C	10755	" " Set Screw
*235251	----	Bed
202258	10751	" Hinge Connection (2)
200570E	10755	" " " Screw (4)
235252	14160	" Plate (back), to be used with 120009
210505	10751	Bed Plate (back), to be used with 226883
200577H	10755	Bed Plate (back) Screw
210616	10751	" Slide (front)
210530	13174	Bobbin
210846	10736	" Case Base
210729	10736	" " Cap with 200592C, 201016C and 210845
210915	10736	Bobbin Case Cap complete, Nos. 200964E, 210729, 210736 and 210914
210913	10736	Bobbin Case Latch
210914	14163	" " " 210913 with 210734 and 210735
210735	13197	Bobbin Case Latch Fulcrum Pin ..
210734	13197	" " " Lever
210736	13197	" " " Spring
200964E	13197	" " " Stop Screw ..
210764	13197	" " Stop
200076E	14158	" " " Screw
210845	13197	" " Tension Spring
201016C	10736	" " " " Regulating Screw
200592C	13178	Bobbin Case Tension Spring Screw
210847	10736	Bobbin Case complete, Nos. 210846 and 210915
210681	----	Face Plate
202135	10755	" " Position Pin
200462B	10755	" " Thumb Screw
210682	14159	Face Plate complete, Nos. 210681, 210684 and two 200137U
210512	14159	Feed Bar
210513	----	" " 210512 with 200641C, 201522E and 202623

No.	Plate	Name
200641C	10755	Feed Bar Hinge Screw (driving) ..
201522E	13197	" " " " Nut
202276	10760	" " Slide Block
210514	10760	" " " " Crank with 200035E
210515	10760	Feed Bar Slide Block Crank 210514 with 200243E, 201531E and 202276
200035E	10760	Feed Bar Slide Block Crank Pinch Screw
200243E	10760	Feed Bar Slide Block Hinge Screw
201531E	10760	" " " " " " " Nut
235253	14166	Feed Dog, to be used with 120009 ..
210524	14166	" " " " " " 226883 ..
200106E	10755	" " Screw (2)
202297	10752	" Driving Connection with 200054E and 202277
202624	10760	Feed Driving Connection Crank with 200038C
200038C	10760	Feed Driving Connection Crank Pinch Screw
200545C	10760	Feed Driving Connection Hinge Screw
201518E	10755	Feed Driving Connection Hinge Screw Nut
202277	----	Feed Driving Connection Oil Packing (wick)
200054E	10755	Feed Driving Connection Pinch Screw
210559	10756	Feed Driving Connection Stop Collar with two 200378C
200378C	10760	Feed Driving Connection Stop Collar Set Screw
202300	10753	Feed Driving Eccentric Regulating Bracket
203098	10753	Feed Driving Eccentric Regulating Bracket 202300 with 202635, two each 201014C and 201525E
201014C	13197	Feed Driving Eccentric Regulating Bracket Hinge Screw
201525E	10755	Feed Driving Eccentric Regulating Bracket Hinge Screw Nut
202301	10755	Feed Driving Eccentric Regulating Bracket Plunger
202595	10755	Feed Driving Eccentric Regulating Bracket Plunger Spring
200607C	10755	Feed Driving Eccentric Regulating Bracket Plunger Spring Stop Screw

No.	Plate	Name
201014c	13197	Feed Driving Eccentric Regulating Bracket Stop Screw
201525E	10755	Feed Driving Eccentric Regulating Bracket Stop Screw Nut
200429c	10755	Feed Driving Eccentric Regulating Screw
200383c	10755	Feed Driving Eccentric Regulating Screw Check Screw
202623	10752	Feed Driving Rock Shaft
202625	10760	" " " " Stop Collar with two 200383c (2)
200383c	10755	Feed Driving Rock Shaft Stop Collar Set Screw
235202	14159	Feed Lifting Cam with 200327c and 201470c
200327c	10755	Feed Lifting Cam Set Screw
201470c	14158	" " " " "
235203	14159	" " Connection
*210645	-----	" " Crank
210589	10760	" " " " 210645 with 200050c and 200378c
200050c	10760	Feed Lifting Connection Crank Pinch Screw
200378c	10760	Feed Lifting Connection Crank Set Screw
200545c	10760	Feed Lifting Connection Hinge Screw (lower)
201518E	10755	Feed Lifting Connection Hinge Screw (lower) Nut
200545E	10760	Feed Lifting Connection Hinge Screw (upper)
200386c	14158	Feed Lifting Connection Hinge Screw (upper) Set Screw
204479	14158	Feed Lifting Connection Hinge Screw (upper) Set Screw Packing (brass)
235204	14159	Feed Lifting Connection Lever with 200386c and 235205
201822	14158	Feed Lifting Connection Lever Roller
235205	14158	Feed Lifting Connection Lever Roller Stud
235206	14159	Feed Lifting Connection Lever Shaft
235207	-----	Feed Lifting Connection Lever Shaft 235206 with 201822, 205508 and 235204
203244	14158	Feed Lifting Connection Lever Shaft Collar with two 200393c ..

No.	Plate	Name
200393c	14158	Feed Lifting Connection Lever Shaft Collar Set Screw
205508	14158	Feed Lifting Connection Lever Shaft Position Pin
210531	10752	Feed Lifting Rock Shaft (hollow) and Hook Driving Shaft Bearing
202625	10760	Feed Lifting Rock Shaft Stop Collar with two 200383c
200383c	10755	Feed Lifting Rock Shaft Stop Collar Set Screw
207070	10753	Feed Regulating Spindle with 202311, 202443, 202619 and 210554
*202311	-----	Feed Regulating Spindle Head ...
202443	14158	" " " " Pin
202619	10756	" " " " Position Pin
210554	10756	Feed Regulating Spindle Spring (flat)
226880	---	Hat Sweat Band Guide
200126F	14161	" " " " Screw
226881	---	" " Binding Guide
201560D	13199	" " " " Thumb Nut
226882	---	" " Folder Body
200459D	13197	" " " " Thumb Screw
226883	13199	Hat Sweat Folder and Guide complete, adjustable, for strips from $\frac{5}{8}$ to $1\frac{1}{4}$ in. wide, Nos. 200126F, 200459D, 201560D and 226880 to 226882
36147	14162	Hat Sweat Band Guide
1443B	14161	" " " " Screw ...
658B	14161	" " " " Thumb Screw
36148	14162	Hat Sweat Edge Guide
1423B	14161	" " " " Screw
658B	14161	" " " " Thumb Screw
120007	14162	" " Frame
36150	14161	" " Guide (wire), for leather sweat
36155	14161	Hat Sweat Guide (tube), for ready folded facings
1423B	14161	Hat Sweat Guide Screw
36151	14161	Hat Sweat Reed and Wire Guide
120008	14162	" " " " " " " " Arm
36006	14161	Hat Sweat Reed and Wire Guide Arm Friction Washer
96B	14161	Hat Sweat Reed and Wire Guide Arm Hinge Screw

No.	Plate	Name
1443B	14161	Hat Sweat Reed and Wire Guide Screw
36153	14161	Hat Sweat Strip Folder
1423B	14161	" " " " Screw
36154	14162	" " " " Guide
1443B	14161	" " " " Screw
658B	14161	" " " " Thumb Screw
120009	14162	Hat Sweat Attachment complete, Nos. 96B, 36006, 36147, 36148, 36150, 36151, 36153 to 36155, 120007, 120008, three each 658B, 1423B and four 1443B
200076C	14158	Hat Sweat Attachment Screw
207125	14158	" " " " Washer
*210532	—	Hook (sewing)
210533	13197	" 210532 with 200145H, 203101, 210536, 210541 and three 200596F
210775	13197	Hook and Bobbin Case complete, Nos. 210533 and 210847
210614	10757	Hook Driving Bevel Pinion (steel), 24 teeth, with two 200378C
200378C	10760	Hook Driving Bevel Pinion Set Screw
210535	10752	Hook Driving Bevel Pinion Shaft
202661	10753	" " " " " " Belt Pulley with 202324 and two 200378C
200378C	10760	Hook Driving Bevel Pinion Shaft Belt Pulley Set Screw
202324	10757	Hook Driving Bevel Pinion Shaft Belt Pulley Spring Flange
210536	13174	Hook Gib
200596F	13174	" " Screw
203101	—	" Oil Wick
200915F	10757	" Position Screw
210537	10757	" Shaft (hollow)
210615	10757	" " Bevel Gear (steel), 24 teeth, with two 200382C
200382C	13197	Hook Shaft Bevel Gear Set Screw
210539	10757	" " Bushing
210621	—	" " " 210539 with 200931F and 210537
200335C	10755	Hook Shaft Bushing Set Screw ...
200363C	10736	" " " " " " ...
202355	10759	" " " " " " Pack- ing (brass)
200931F	10757	Hook Shaft Position Screw
210541	13174	" Washer Needle Guard
200145H	13174	" " " " " Screw..

No.	Plate	Name
202445	10958	Knee Lifter Connection Lever with 202446
202786	—	Knee Lifter Connection Lever 202445 with 200224H, 200262H, 202447 and 202449
200224H	10759	Knee Lifter Connection Lever Hinge Screw
202447	10958	Knee Lifter Connection Lever Lift- ing Rod with 202302
202302	13178	Knee Lifter Connection Lever Lift- ing Rod Cotter Pin
202446	13197	Knee Lifter Connection Lever Pin
202449	14159	Knee Lifter Lifting Lever
200262H	10759	" " " " Hinge Screw
202976	10761	Needle Bar with 200141F
210543	10761	" " Connecting Link
202333	10761	" " " " Stud with 202254
202254	—	Needle Bar Connecting Link Stud Oil Packing (wick)
200383C	10755	Needle Bar Connecting Link Stud Set Screw
200374C	10761	Needle Bar Connecting Link Stud Set Screw
210544	10761	Needle Bar Connecting Stud with 202277
210585	—	Needle Bar Connecting Stud 210544 with 210545
202277	—	Needle Bar Connecting Stud Oil Packing (wick)
210545	10761	Needle Bar Connecting Stud Swivel with 200387C
210725	10753	Needle Bar Crank with 200335C, 200374C, 200383C, 200428C and 202333
203172	10761	Needle Bar Crank Friction Washer
200428C	10761	" " " Position Screw ..
200335C	10755	" " " Set Screw
210726	—	Needle Bar Crank complete, Nos. 202398 to 202400, 210543, 210585 and 210725
210546	14160	Needle Bar Frame with 200070C ..
210542	—	" " " 210546 with 202976
210547	10756	" " " Guide Stud
200334C	10756	" " " " " " Set Screw
210548	10756	Needle Bar Frame Hinge Stud ...
200334C	10756	" " " " " " Set Screw

No.	Plate	Name
235208	14160	Needle Bar Frame Pitman
235209	14160	" " " " Fork
200089c	14158	" " " " " Screw
207125	14158	" " " " " "
		Washer
202277	—	Needle Bar Frame Pitman Oil Pack- ing (wick)
205975	14158	Needle Bar Frame Pitman Spring
235210	14160	" " " " " "
		Bracket
200247F	14158	Needle Bar Frame Pitman Spring Bracket Hinge Screw
201528E	14158	Needle Bar Frame Pitman Spring Bracket Hinge Screw Nut
235211	14158	Needle Bar Frame Pitman Spring Collar
201471B	14158	Needle Bar Frame Pitman Spring Regulating Thumb Screw
201673D	14158	Needle Bar Frame Pitman Spring Regulating Thumb Screw Check Nut
235212	14158	Needle Bar Frame Pitman Stud ..
200070c	13197	" " " " " Set Screw
235213	—	Needle Bar Frame Pitman com- plete, Nos. 200247F, 201528E, 202277, 207125, 210707, 210712, 235208 to 235210, two each 200089c, 200919c and 201522E ...
200387c	14158	Needle Bar Set Screw
200141F	10761	" Set Screw
235214	14158	" Vibrator Cam
200031c	14158	" " " Screw
235215	14160	" " " Shaft
210551	14160	" " " " Bearing and Cover
200566D	10756	Needle Vibrator Cam Shaft Bearing and Cover Screw (4)
210559	10756	Needle Vibrator Cam Shaft Collar with two 200378c
200378c	10760	Needle Vibrator Cam Shaft Collar Set Screw
210712	13174	Needle Vibrator Crank with 200378c and 200917c
210707	13174	Needle Vibrator Crank Link
200919c	14158	" " " " Hinge Screw
201522E	13197	Needle Vibrator Crank Link Hinge Screw Nut

No.	Plate	Name
210723	14158	Needle Vibrator Crank Link Oil Tube
200917c	14158	Needle Vibrator Crank Position Screw
200378c	10760	Needle Vibrator Crank Set Screw
210711	13174	" " " Shaft
235216	14160	" " Gear (spiral) with 200382c and 201472c
235217	—	Needle Vibrator Gear 235216 with 200031c and 235214
200382c	13197	Needle Vibrator Gear Set Screw ..
201472c	14158	" " " " " "
203172	10761	" " " Thrust Washer
235218	14160	" " Pinion (spiral) with two 200382c
200382c	13197	Needle Vibrator Pinion Set Screw
210770	14160	" " Regulating Lever with 200378c and 200917c
235261	14162	Needle Vibrator Regulating Lever Position Bracket (indexed) with 200378c and 200917c
200917c	14158	Needle Vibrator Regulating Lever Position Bracket Position Screw
200378c	10760	Needle Vibrator Regulating Lever Position Bracket Set Screw
200917c	14158	Needle Vibrator Regulating Lever Position Screw
200378c	10760	Needle Vibrator Regulating Lever Set Screw
210772	14158	Needle Vibrator Regulating Lever Slide
201556D	14158	Needle Vibrator Regulating Lever Slide Thumb Nut
202335	10751	Presser Bar (hollow) with 200074F
207072	10759	" " Bushing
200352c	10759	" " " Set Screw
202554	10759	" " Lifter
200653c	10759	" " " Hinge Screw ...
210561	10759	" " Lifting Releasing Lev- er Bracket
200260D	10759	Presser Bar Lifting Releasing Lev- er Bracket Guide Screw
202342	10759	Presser Bar Lifting Releasing Lev- er Bracket Spring (spiral)
202337	10759	Presser Bar Position Guide
202338	10759	" " " " Lever with 200086F
200086F	10759	Presser Bar Position Guide Lever Pinch Screw

No.	Plate	Name
200352c	10759	Presser Bar Position Guide Set Screw
202378	10748	Presser Bar Spring (heavy)
202346	10751	" " " Stop Rod
200492B	10759	" " Thumb Screw (pressure regulating)
200475B	10759	Presser Bar Thumb Screw Thumb Set Screw
202355	10759	Presser Bar Thumb Screw Thumb Set Screw Packing (brass)
235254	14165	Presser Foot, to be used with 120009
210680	14165	" " " " " " 226883
200074F	10759	" " Screw
202398	10761	Take-up Lever
202399	10761	" " Driving Stud with 202277
202277	—	Take-up Lever Driving Stud Oil Packing (wick)
202400	10761	Take-up Lever Hinge Stud with 202423
202423	—	Take-up Lever Hinge Stud Oil Packing (wick)
200383c	10755	Take-up Lever Hinge Stud Set Screw
202401	10761	Take-up Lever Oiling Felt
200132E	10761	" " " " Screw
202402	10762	Tension Disc (back)
210967	14158	" " (front)
202404	10762	" Release Plunger
235221	14158	" " Washer
202407	10881	" Spring
200625F	10762	" Stud with 204925
200061c	—	" " Set Screw
204925	13197	" " Washer
201572B	10881	" Thumb Nut
235222	—	Tension complete, Nos. 200625c, 201572B, 202402, 202407, 202682, 210967 and 235221
202682	14161	Thread Controller Spring
202411	10762	" " " Stop
200132E	10761	" " " " Screw
210954	14161	" Guide (lower)
210955	14161	" " (upper)
210595	14161	" " (on side of Arm)
202412	10756	" " (on top of Arm)
200582H	14161	" " Screw (3)
210683	—	" Retainer Bracket with 200397H
200137H	13178	Thread Retainer Bracket Screw ..

No.	Plate	Name
210684	13178	Thread Retainer Bracket complete, Nos. 210683, 210957, 210958, 210992 and 210993
210960	14161	Thread Retainer Disc
210961	14161	" " Plunger
210962	14161	" " " Spring
210993	13178	" " Sleeve
210963	14161	" " Socket
200389c	13178	" " " Set Screw ..
210992	13178	" " Spring
210957	13178	" " Stud
210958	13178	" " Collar
200397H	13178	" " " Set Screw ...
235255	14166	Throat Plate, 56 needle hole, for needle sizes 10 and 11, to be used with 120009
210604	14166	Throat Plate, 53 needle hole, for needle sizes 12 and 13, to be used with 226883
200577H	10755	Throat Plate Screw (2)

LIST OF PARTS COMPLETE
FOR
MACHINE No. 107w10

HIGH SPEED ZIGZAG

For Coat Collar Work

No.	Plate	Name
*235201	—	Arm
203087	10751	" Cap
200278H	10755	" " Screw
202248	10755	" " " Washer
203089	10751	" " Spool Holder Base
203090	—	" " " " " 203089 with 200079H and 204296
200585H	13197	Arm Cap Spool Holder Base Screw
204296	10751	" " " " Wire
200079H	13197	" " " " " Hinge Screw
203088	10751	Arm Cap and Spool Holder complete, Nos. 203087, 203090 and two 200585H
204235	10755	Arm Position Pin (2)
200010E	10755	" Screw (3)
202005	10755	" " Washer (3)
202249	10753	" Shaft with 200357E and 203100
202243	10753	" " Bushing (back) with 202244
202244	—	Arm Shaft Bushing (back) Oil Packing (wick)
200338C	10755	Arm Shaft Bushing (back) Set Screw
202245	10753	Arm Shaft Bushing (front) with 202036 and 202260
202260	—	Arm Shaft Bushing (front) Oil Packing (wick)
200502H	10755	Arm Shaft Bushing (front) Oil Packing Thumb Screw
202036	10755	Arm Shaft Bushing (front) Position Pin
200341C	10755	Arm Shaft Bushing (front) Set Screw
210503	10753	Arm Shaft Connection Belt
202635	10753	" " " " Pulley with 200327C, 200602E and two 202253

No.	Plate	Name
200602E	10755	Arm Shaft Connection Belt Pulley Position Screw
200327C	10755	Arm Shaft Connection Belt Pulley Set Screw
202253	10757	Arm Shaft Connection Belt Pulley Spring Flange
203100	—	Arm Shaft Oil Packing (wick) ...
200357E	10755	" " " " Stop Screw..
202255	10752	Balance Wheel (belt groove 2 1/2 in. diam.) with 200328C and 200335C
200328C	10755	Balance Wheel Position Screw ...
200335C	10755	" " Set Screw
*210501	—	Bed
202258	10751	" Hinge Connection (2)
200570E	10755	" " " Screw (4)
210505	10751	" Plate (back)
200577H	10755	" " " Screw
210616	10751	" Slide (front)
210539	13174	Bobbin
210846	10736	" Case Base
210729	10736	" " Cap with 200592C, 201016C and 210845
210915	10736	Bobbin Case Cap complete, Nos. 200964E, 210729, 210736 and 210914
210913	10736	Bobbin Case Latch
210914	14163	" " " 210913 with 210734 and 210735
210735	13197	Bobbin Case Latch Fulcrum Pin ..
210734	13197	" " " Lever
210736	13197	" " " Spring
200964E	13197	" " " Stop Screw ...
210764	13197	" " Stop
200076E	14158	" " " Screw
210845	13197	" " Tension Spring
201016C	10736	" " " " Regu- lating Screw
200592C	13178	Bobbin Case Tension Spring Screw
210847	10736	Bobbin Case complete, Nos. 210846 and 210915
210681	—	Face Plate
202135	10755	" " Position Pin
200462H	10755	" " Thumb Screw
210682	14159	Face Plate complete, Nos. 210681, 210684 and two 200137H
210512	14159	Feed Bar
210513	—	" " 210512 with 200641C, 201522E and 202623
200641C	10755	Feed Bar Hinge Screw (driving)..
201522E	13197	" " " " Nut
202276	10760	" " Slide Block

No.	Plate	Name
210514	10760	Feed Bar Slide Block Crank with 200035E
210515	10760	Feed Bar Slide Block Crank 210514 with 200243E, 201531E and 202276
200035E	10760	Feed Bar Slide Block Crank Pinch Screw
200243E	10760	Feed Bar Slide Block Hinge Screw
201531E	10760	" " " " " " " " Nut
210517	14165	Feed Dog
200106E	10755	" " Screw (2)
202297	10752	" Driving Connection with 200054E and 202277
202624	10760	Feed Driving Connection Crank with 200038c
200038c	10760	Feed Driving Connection Crank Pinch Screw
200545c	10760	Feed Driving Connection Hinge Screw
201518E	10755	Feed Driving Connection Hinge Screw Nut
202277	—	Feed Driving Connection Oil Packing (wick)
200054E	10755	Feed Driving Connection Pinch Screw
210559	10756	Feed Driving Connection Stop Collar with two 200378c
200378c	10760	Feed Driving Connection Stop Collar Set Screw
202300	10753	Feed Driving Eccentric Regulating Bracket
203098	10753	Feed Driving Eccentric Regulating Bracket 202300 with 202635, two each 201014c and 201525E
201014c	13197	Feed Driving Eccentric Regulating Bracket Hinge Screw
201525E	10755	Feed Driving Eccentric Regulating Bracket Hinge Screw Nut
202301	10755	Feed Driving Eccentric Regulating Bracket Plunger
202595	10755	Feed Driving Eccentric Regulating Bracket Plunger Spring
200607c	10755	Feed Driving Eccentric Regulating Bracket Plunger Spring Stop Screw
201014c	13197	Feed Driving Eccentric Regulating Bracket Stop Screw
201525E	10755	Feed Driving Eccentric Regulating Bracket Stop Screw Nut

No.	Plate	Name
200429c	10755	Feed Driving Eccentric Regulating Screw
200383c	10755	Feed Driving Eccentric Regulating Screw Check Screw
202623	10752	Feed Driving Rock Shaft
202625	10760	" " " " Stop Collar with two 200383c (2)
200383c	10755	Feed Driving Rock Shaft Stop Collar Set Screw
235202	14159	Feed Lifting Cam with 200327c and 201470c
200327c	10755	Feed Lifting Cam Set Screw
201470c	14158	" " " " " "
235203	14159	" " Connection
*210645	—	" " " " Crank
210589	10760	" " " " 210645 with 200050c and 200378c
200050c	10760	Feed Lifting Connection Crank Pinch Screw
200378c	10760	Feed Lifting Connection Crank Set Screw
200545c	10760	Feed Lifting Connection Hinge Screw (lower)
201518E	10755	Feed Lifting Connection Hinge Screw (lower) Nut
200545c	10760	Feed Lifting Connection Hinge Screw (upper)
200386c	14158	Feed Lifting Connection Hinge Screw (upper) Set Screw
204479	14158	Feed Lifting Connection Hinge Screw (upper) Set Screw Packing (brass)
235204	14159	Feed Lifting Connection Lever with 200386c and 235205
201822	14158	Feed Lifting Connection Lever Roller
235205	14158	Feed Lifting Connection Lever Roller Stud
235206	14159	Feed Lifting Connection Lever Shaft
235207	—	Feed Lifting Connection Lever Shaft 235206 with 201822, 205508 and 235204
203244	14158	Feed Lifting Connection Lever Shaft Collar with two 200393c ..
200393c	14158	Feed Lifting Connection Lever Shaft Collar Set Screw
205508	14158	Feed Lifting Connection Lever Shaft Position Pin

No.	Plate	Name
210531	10752	Feed Lifting Rock Shaft (hollow) and Hook Driving Shaft Bearing
202625	10760	Feed Lifting Rock Shaft Stop Collar with two 200383c
200383c	10755	Feed Lifting Rock Shaft Stop Collar Set Screw
207070	10753	Feed Regulating Spindle with 202311, 202443, 202619 and 210554
*202311	---	Feed Regulating Spindle Head
202443	14158	" " " " Pin
202619	10756	" " " " Position Pin
210554	10756	Feed Regulating Spindle Spring (flat)
*210532	---	Hook (sewing)
210533	13197	" 210532 with 200145u, 203101, 210536, 210541 and three 200596f
210775	13197	Hook and Bobbin Case complete, Nos. 210533 and 210847
210614	10757	Hook Driving Bevel Pinion (steel), 24 teeth, with two 200378c
200378c	10760	Hook Driving Bevel Pinion Set Screw
210535	10752	Hook Driving Bevel Pinion Shaft
202661	10753	" " " " " " Belt Pulley with 202324 and two 200378c
200378c	10760	Hook Driving Bevel Pinion Shaft Belt Pulley Set Screw
202324	10757	Hook Driving Bevel Pinion Shaft Belt Pulley Spring Flange
210536	13174	Hook Gib
200596f	13174	" " Screw
203101	---	" Oil Wick
200915f	10757	" Position Screw
210537	10757	" Shaft (hollow)
210615	10757	" " Bevel Gear (steel), 24 teeth, with two 200382c
200382c	13197	Hook Shaft Bevel Gear Set Screw
210539	10757	" " Bushing
210621	---	" " " 210539 with 200931f and 210537
200335c	10755	Hook Shaft Bushing Set Screw
200363c	10736	" " " " " "
202355	10759	" " " " " " Packing (brass)
200931f	10757	Hook Shaft Position Screw
210541	13174	" Washer Needle Guard
200145u	13174	" " " " Screw

No.	Plate	Name
202445	10958	Knee Lifter Connection Lever with 202446
202786	---	Knee Lifter Connection Lever 202445 with 200224u, 200262u, 202447 and 202449
200224u	10759	Knee Lifter Connection Lever Hinge Screw
202447	10958	Knee Lifter Connection Lever Lifting Rod with 202302
202302	13178	Knee Lifter Connection Lever Lifting Rod Cotter Pin
202446	13197	Knee Lifter Connection Lever Pin
202449	14159	" " Lifting Lever
200262u	10759	" " " " Hinge Screw
202976	10761	Needle Bar with 200141f
210543	10761	" " Connecting Link
202333	10761	" " " " Stud with 202254
202254	---	Needle Bar Connecting Link Stud Oil Packing (wick)
200383c	10755	Needle Bar Connecting Link Stud Set Screw
200374c	10761	Needle Bar Connecting Link Stud Set Screw
210544	10761	Needle Bar Connecting Stud with 202277
210585	---	Needle Bar Connecting Stud 210544 with 210545
202277	---	Needle Bar Connecting Stud Oil Packing (wick)
210545	10761	Needle Bar Connecting Stud Swivel with 200387c
210725	10753	Needle Bar Crank with 200335c, 200374c, 200383c, 200428c and 202333
203172	10761	Needle Bar Crank Friction Washer
200428c	10761	" " " Position Screw
200335c	10755	" " " Set Screw
210726	---	Needle Bar Crank complete, Nos. 202398 to 202400, 210543, 210585 and 210725
210546	14160	Needle Bar Frame with 200070c
210542	---	" " " 210546 with 202976
210547	10756	" " " Guide Stud
200334c	10756	" " " " " Set Screw
210548	10756	Needle Bar Frame Hinge Stud
200334c	10756	" " " " " Set Screw

No.	Plate	Name
235208	14160	Needle Bar Frame Pitman
235209	14160	" " " " Fork
200089c	14158	" " " " " Screw
207125	14158	" " " " " " Washer
202277	---	Needle Bar Frame Pitman Oil Pack- ing (wick)
205975	14158	Needle Bar Frame Pitman Spring
235210	14160	" " " " " " Bracket
200247F	14158	Needle Bar Frame Pitman Spring Bracket Hinge Screw
201528E	14158	Needle Bar Frame Pitman Spring Bracket Hinge Screw Nut
235211	14158	Needle Bar Frame Pitman Spring Collar
201471B	14158	Needle Bar Frame Pitman Spring Regulating Thumb Screw
201673D	14158	Needle Bar Frame Pitman Spring Regulating Thumb Screw Check Nut
235212	14158	Needle Bar Frame Pitman Stud ...
200070c	13197	" " " " " " Set Screw
235213	---	Needle Bar Frame Pitman com- plete. Nos. 200247F, 201528E, 202277, 207125, 210707, 210712, 235208 to 235210, two each 200089c, 200919c and 201522E ...
200387E	14158	Needle Bar Set Screw
200141F	10761	" Set Screw
235214	14158	" Vibrator Cam
200031c	14158	" " " Screw
235215	14160	" " " Shaft
210551	14160	" " " " Bearing and Cover
200566D	10756	Needle Vibrator Cam Shaft Bear- ing and Cover Screw (4)
210559	10756	Needle Vibrator Cam Shaft Collar with two 200378c
200378c	10760	Needle Vibrator Cam Shaft Collar Set Screw
210712	13174	Needle Vibrator Crank with 200378c and 200917c
210707	13174	Needle Vibrator Crank Link
200919c	14158	" " " " Hinge Screw
201522E	13197	Needle Vibrator Crank Link Hinge Screw Nut

No.	Plate	Name
210723	14158	Needle Vibrator Crank Link Oil Tube
200917c	14158	Needle Vibrator Crank Position Screw
200378c	10760	Needle Vibrator Crank Set Screw ..
210711	13174	" " " Shaft
235216	14160	" " Gear (spiral) with 200382c and 201472c
235217	---	Needle Vibrator Gear 235216 with 200031c and 235214
200382c	13197	Needle Vibrator Gear Set Screw ..
201472c	14158	" " " " " " ..
203172	10761	" " " Thrust Washer
235218	14160	" " Pinion (spiral) with two 200382c
200382c	13197	Needle Vibrator Pinion Set Screw ..
210770	14160	" " Regulating Lever with 200378c and 200917c
235261	14162	Needle Vibrator Regulating Lever Position Bracket (indexed) with 200378c and 200917c
200917c	14158	Needle Vibrator Regulating Lever Position Bracket Position Screw ..
200378c	10760	Needle Vibrator Regulating Lever Position Bracket Set Screw
200917c	14158	Needle Vibrator Regulating Lever Position Screw
200378c	10760	Needle Vibrator Regulating Lever Set Screw
210772	14158	Needle Vibrator Regulating Lever Slide
201556D	14158	Needle Vibrator Regulating Lever Slide Thumb Nut
202335	10751	Presser Bar (hollow) with 200074F ..
207072	10759	" " Bushing
200352c	10759	" " " Set Screw
202554	10759	" " Lifter
200653c	10759	" " " Hinge Screw ...
210561	10759	" " Lifting Releasing Lev- er Bracket
200260D	10759	Presser Bar Lifting Releasing Lev- er Bracket Guide Screw
202342	10759	Presser Bar Lifting Releasing Lev- er Bracket Spring (spiral)
202337	10759	Presser Bar Position Guide
202338	10759	" " " " Lever with 200086F
200086F	10759	Presser Bar Position Guide Lever Pinch Screw

No.	Plate	Name
200352c	10759	Presser Bar Position Guide Set Screw
202378	10748	Presser Bar Spring (heavy)
202346	10751	" " " Stop Rod
200492R	10759	" " Thumb Screw (pressure regulating)
200475B	10759	Presser Bar Thumb Screw Thumb Set Screw
202355	10759	Presser Bar Thumb Screw Thumb Set Screw Packing (brass)
210689	14164	Presser Foot (left) with 200172H and 210691
210690	14164	Presser Foot (right)
210570	14164	" " Bracket
210571	14164	" " Guide with 200141F
200141F	10761	" " " Screw
210574	14164	" " Spring
202512	14164	" " Stop Pin
210691	14164	" " Thread Draw
200172H	10756	" " " " Screw
210692	14164	Presser Foot (compensating) complete, Nos. 210570, 210689, 210690, two each 202512, 210571 and 210574
200074F	10759	Presser Foot Screw
202398	10761	Take-up Lever
202399	10761	" " Driving Stud with 202277
202277	—	Take-up Lever Driving Stud Oil Packing (wick)
202400	10761	Take-up Lever Hinge Stud with 202423
202423	—	Take-up Lever Hinge Stud Oil Packing (wick)
200383C	10755	Take-up Lever Hinge Stud Set Screw
202401	10761	Take-up Lever Oiling Felt
200132E	10761	" " " " Screw
202402	10762	Tension Disc (back)
210967	14158	" " (front)
202404	10762	" Release Plunger
235221	14158	" " Washer
202407	10881	" Spring
200625F	10762	" Stud with 204925
200061C	—	" " Set Screw
204925	13197	" " Washer
201572B	10881	" Thumb Nut
235222	—	Tension complete, Nos. 200625F, 201572B, 202402, 202407, 202682, 210967 and 235221

No.	Plate	Name
202682	14161	Thread Controller Spring
202411	10762	" " " Stop
200132E	10761	" " " " Screw
210954	14161	" Guide (lower)
210955	14161	" " (upper)
210595	14161	" " (on side of Arm)
202412	10756	" " (on top of Arm)
200582H	14161	" " Screw (3)
210683	—	" Retainer Bracket with 200397H
200137H	13178	" " " Screw
210684	13178	Thread Retainer Bracket complete, Nos. 210683, 210957, 210958, 210992 and 210993
210960	14161	Thread Retainer Disc
210961	14161	" " Plunger
210962	14161	" " " Spring
210993	13178	" " Sleeve
210963	14161	" " Socket
200389c	13178	" " " Set Screw
210992	13178	" " Spring
210957	13178	" " Stud
210958	13178	" " " Collar
200397H	13178	" " " Set Screw
210597	14165	Throat Plate, 53 needle hole, for needle sizes 12 and 13
200577H	10755	Throat Plate Screw (2)

LIST OF PARTS COMPLETE
FOR
MACHINE No. 107w11

HIGH SPEED ZIGZAG

For Closing Heel Seams in Shoes

No.	Plate	Name
*210701	---	Arm
203087	10751	" Cap
200278H	10755	" " Screw
202248	10755	" " Washer
203089	10751	" " Spool Holder Base
203090	---	" " " " " 203089 with 200079H and 204296
200585H	13197	Arm Cap Spool Holder Base Screw
204296	10751	" " " " Wire
200079H	13197	" " " " Hinge Screw
203088	10751	Arm Cap and Spool Holder complete, Nos. 203087, 203090 and two 200585H
204235	10755	Arm Position Pin (2)
200010E	10755	" Screw (3)
202005	10755	" Washer (3)
202249	10753	" Shaft with 200357E and 203100
202243	10753	" " Bushing (back) with 202244
202244	---	Arm Shaft Bushing (back) Oil Packing (wick)
200338C	10755	Arm Shaft Bushing (back) Set Screw
202245	10753	Arm Shaft Bushing (front) with 202036 and 202260
202260	---	Arm Shaft Bushing (front) Oil Packing (wick)
200502B	10755	Arm Shaft Bushing (front) Oil Packing Thumb Screw
202036	10755	Arm Shaft Bushing (front) Position Pin
200341C	10755	Arm Shaft Bushing (front) Set Screw
210503	10753	Arm Shaft Connection Belt
202635	10753	" " " " Pulley with 200327C, 200602E and two 202253

Parts for Machine No. 107w11

No.	Plate	Name
200602E	10755	Arm Shaft Connection Belt Pulley Position Screw
200327C	10755	Arm Shaft Connection Belt Pulley Set Screw
202253	10757	Arm Shaft Connection Belt Pulley Spring Flange
203100	---	Arm Shaft Oil Packing (wick)
200357E	10755	" " " " Stop Screw
202255	10752	Balance Wheel (belt groove 2 1/4 in. diam.) with 200328C and 200335C
200328C	10755	Balance Wheel Position Screw
200335C	10755	" " Set Screw
*210760	---	Bed
202258	10751	" Hinge Connection (2)
200570E	10755	" " Screw (4)
210761	---	" Plate (back)
210762	14162	" " 210761 with 210763 and two 200132B
200577H	10755	Bed Plate (back) Screw
210616	10751	" Slide (front)
210530	13174	Bobbin
210846	10736	" Case Base
210729	10736	" " Cap with 200592C, 201016C and 210845
210915	10736	Bobbin Case Cap complete, Nos. 200964E, 210729, 210736 and 210914
210913	10736	Bobbin Case Latch
210914	14163	" " " 210913 with 210734 and 210735
210735	13197	Bobbin Case Latch Fulcrum Pin
210734	13197	" " " Lever
210736	13197	" " " Spring
200964E	13197	" " " Stop Screw
210764	13197	" " " Stop
200076E	14158	" " " Screw
210845	13197	" " Tension Spring
201016C	10736	" " " " Regulat- ing Screw
200592C	13178	Bobbin Case Tension Spring Screw
210847	10736	Bobbin Case complete, Nos. 210846 and 210915
210511	10751	Face Plate
202135	10755	" " Position Pin
200462B	10755	" " Thumb Screw
210512	14159	" Bar
210513	---	" " 210512 with 200641C, 201522E and 202623
200641C	10755	Feed Bar Hinge Screw (driving)
201522E	13197	" " " " Nut
202276	10760	" " Slide Block

No.	Plate	Name
210514	10760	Feed Bar Slide Block Crank with 200035E
210515	10760	Feed Bar Slide Block Crank 210514 with 200243E, 201531E and 202276
200035E	10760	Feed Bar Slide Block Crank Pinch Screw
200243E	10760	Feed Bar Slide Block Hinge Screw
201531E	10760	" " " " " " Nut
210525	10768	Feed Dog
200106E	10755	" " Screw (2)
202297	10752	" Driving Connection with 200054E and 202277
202624	10760	Feed Driving Connection Crank with 200038c
200038c	10760	Feed Driving Connection Crank Pinch Screw
200545c	10760	Feed Driving Connection Hinge Screw
201518E	10755	Feed Driving Connection Hinge Screw Nut
202277	—	Feed Driving Connection Oil Packing (wick)
200054E	10755	Feed Driving Connection Pinch Screw
202300	10753	Feed Driving Eccentric Regulating Bracket
203098	10753	Feed Driving Eccentric Regulating Bracket 202300 with 202635, two each 201014c and 201525E
201014c	13197	Feed Driving Eccentric Regulating Bracket Hinge Screw
201525E	10755	Feed Driving Eccentric Regulating Bracket Hinge Screw Nut
202301	10755	Feed Driving Eccentric Regulating Bracket Plunger
202595	10755	Feed Driving Eccentric Regulating Bracket Plunger Spring
200607c	10755	Feed Driving Eccentric Regulating Bracket Plunger Spring Stop Screw
201014c	13197	Feed Driving Eccentric Regulating Bracket Stop Screw
201525E	10755	Feed Driving Eccentric Regulating Bracket Stop Screw Nut
200429c	10755	Feed Driving Eccentric Regulating Screw
200383c	10755	Feed Driving Eccentric Regulating Screw Check Screw

No.	Plate	Name
202623	10752	Feed Driving Rock Shaft
202625	10760	" " " " Stop Collar with two 200383c (2)
200383c	10755	Feed Driving Rock Shaft Stop Collar Set Screw
202306	10752	Feed Lifting Connection with 200054E and 202277
*210645	—	Feed Lifting Connection Crank
210589	10760	" " " " 210645 with 200050c and 200378c
200050c	10760	Feed Lifting Connection Crank Pinch Screw
200378c	10760	Feed Lifting Connection Crank Set Screw
202307	10760	Feed Lifting Connection Eccentric with 200382c and 200437c
200437c	10760	Feed Lifting Connection Eccentric Position Screw
200382c	13197	Feed Lifting Connection Eccentric Set Screw
200545c	10760	Feed Lifting Connection Hinge Screw
201518E	10755	Feed Lifting Connection Hinge Screw Nut
202277	—	Feed Lifting Connection Oil Packing (wick)
200054E	10755	Feed Lifting Connection Pinch Screw
210531	10752	Feed Lifting Rock Shaft (hollow) and Hook Driving Shaft Bearing
202625	10760	Feed Lifting Rock Shaft Stop Collar with two 200383c
200383c	10755	Feed Lifting Rock Shaft Stop Collar Set Screw
207070	10753	Feed Regulating Spindle with 202311, 202443, 202619 and 210554
*202311	—	Feed Regulating Spindle Head
202443	14158	" " " " Pin
202619	10756	" " " " Position Pin
210554	10756	Feed Regulating Spindle Spring (flat)
210738	14161	Guide
210739	10795	" Lever
210740	—	" " 210739 with 201520u and 210751
210741	10794	Guide Lever Hinge Stud
201516E	14161	" " " " Nut
210742	14161	" " Rest Pin
210743	14161	" " Spring

No.	Plate	Name
210744	14161	Guide Lever Spring Position Pin..
210745	10796	" " Switch Connection ...
210746	—	" " " " 210745 with 201520H, 201528H and 210748
210747	14161	Guide Lever Switch Connection Bushing
210748	14161	Guide Lever Switch Connection Cam
201520H	14161	Guide Lever Switch Connection Cam Check Nut
210749	10794	Guide Lever Switch Connection Fork
201528H	14158	Guide Lever Switch Connection Fork Check Nut
210750	10794	Guide Lever Switch Connection Fork Hinge Pin
210751	10794	Guide Lever Thrust Stud
201520H	14161	" " " " Nut
200098F	14161	" Screw
210763	14161	" Stop Block
200132B	10761	" " " Screw
200459D	13197	" Thumb Screw
*210532	—	Hook (sewing)
210716	14163	" 210532 with 200145H, 203101, 210541, 210703 and three 200596F
210776	14163	Hook and Bobbin Case complete, Nos. 210716 and 210847
210614	10757	Hook Driving Bevel Pinion (steel), 24 teeth, with two 200378c
200378c	10760	Hook Driving Bevel Pinion Set Screw
210535	10752	Hook Driving Bevel Pinion Shaft
202661	10753	" " " " " " Belt Pulley with 202324 and two 200378c
200378c	10760	Hook Driving Bevel Pinion Shaft Belt Pulley Set Screw
202324	10757	Hook Driving Bevel Pinion Shaft Belt Pulley Spring Flange
210703	14163	Hook Gib
200596F	13174	" " Screw
203101	—	" Oil Wick
200915F	10757	" Position Screw
210537	10757	" Shaft (hollow)
210615	10757	" " Bevel Gear (steel), 24 teeth, with two 200382c
200382c	13197	Hook Shaft Bevel Gear Set Screw..
210539	10757	" " Bushing
210621	—	" " " 210539 with 200931F and 210537

No.	Plate	Name
200335c	10755	Hook Shaft Bushing Set Screw
200363c	10736	" " " " " "
202355	10759	" " " " " " Pack- ing (brass)
200931F	10757	Hook Shaft Position Screw
210541	13174	" Washer Needle Guard
200145H	13174	" " " " Screw..
202445	10958	Knee Lifter Connection Lever with 202446
202786	—	Knee Lifter Connection Lever 202445 with 200224H, 200262H, 202447 and 202449
200224H	10759	Knee Lifter Connection Lever Hinge Screw
202447	10958	Knee Lifter Connection Lever Lift- ing Rod with 202302
202302	13178	Knee Lifter Connection Lever Lift- ing Rod Cotter Pin
202446	13197	Knee Lifter Connection Lever Pin
202449	14159	" " Lifting Lever
200262H	10759	" " " " Hinge Screw
202976	10761	Needle Bar with 200141F
210543	10761	" " Connecting Link
202333	10761	" " " " Stud with 202254
202254	—	Needle Bar Connecting Link Stud Oil Packing (wick)
200383c	10755	Needle Bar Connecting Link Stud Set Screw
200374c	10761	Needle Bar Connecting Link Stud Set Screw
210544	10761	Needle Bar Connecting Stud with 202277
210585	—	Needle Bar Connecting Stud 210544 with 210545
202277	—	Needle Bar Connecting Stud Oil Packing (wick)
210545	10761	Needle Bar Connecting Stud Swivel with 200387c
210725	10753	Needle Bar Crank with 200335c, 200374c, 200383c, 200428c and 202333
203172	10761	Needle Bar Crank Friction Washer
200428c	10761	" " " Position Screw ..
200335c	10755	" " " Set Screw
210726	—	Needle Bar Crank complete. Nos. 202398 to 202400, 210543, 210585 and 210725

No.	Plate	Name
210546	14160	Needle Bar Frame with 200070c ..
210542	-----	" " " 210546 with 202976
210547	10756	" " " Guide Stud
200334c	10756	" " " " " Set Screw
210548	10756	Needle Bar Frame Hinge Stud
200334c	10756	" " " " " Set Screw
210705	10795	Needle Bar Frame Pitman
210706	-----	" " " " 210705 with 202277, 210707, 210712, two each 200919c and 201522E
210557	10756	Needle Bar Frame Pitman Eccen- tric Stud
200070c	13197	Needle Bar Frame Pitman Eccen- tric Stud Set Screw
202277	-----	Needle Bar Frame Pitman Oil Packing (wick)
200587c	14158	Needle Bar Set Screw
200141F	10761	" Set Screw
210779	-----	" Vibrator Cam
210780	14163	" " " 210779 with 200378c and 200383c
200378c	10760	Needle Vibrator Cam Set Screw ..
200383c	10755	" " " " " ..
210718	10794	" " " Shaft
210551	14160	" " " " Bearing and Cover
200566D	10756	Needle Vibrator Cam Shaft Bearing and Cover Screw (4)
210559	10756	Needle Vibrator Cam Shaft Collar with two 200378c
200378c	10760	Needle Vibrator Cam Shaft Collar Set Screw
210712	13174	Needle Vibrator Crank with 200378c and 200917c
210707	13174	Needle Vibrator Crank Link
200919c	14158	" " " " Hinge Screw
201522E	13197	Needle Vibrator Crank Link Hinge Screw Nut
210723	14158	Needle Vibrator Crank Link Oil Tube
200917c	14158	Needle Vibrator Crank Position Screw
200378c	10760	Needle Vibrator Crank Set Screw ..
210711	13174	" " " Shaft
210699	-----	" " Gear (spiral) with two 200382c

No.	Plate	Name
200382c	13197	Needle Vibrator Gear Set Screw ..
203172	10761	" " " Thrust Washer
210700	-----	" " Pinion (spiral) with two 200382c
200382c	13197	Needle Vibrator Pinion Set Screw
210708	10795	" " Switch Lever with 200378c and 200917c
210752	-----	Needle Vibrator Switch Lever 210708 with 210749 and 210750 ..
202446	13197	Needle Vibrator Switch Lever Fork Pin
200917c	14158	Needle Vibrator Switch Lever Posi- tion Screw
200378c	10760	Needle Vibrator Switch Lever Set Screw
210713	10795	Needle Vibrator Switch Return Lever with 202446
210722	14163	Needle Vibrator Switch Return Lever Adjusting Plate
200157B	13178	Needle Vibrator Switch Return Lever Adjusting Plate Screw ...
200224U	10759	Needle Vibrator Switch Return Lever Hinge Screw
210714	10794	Needle Vibrator Switch Return Lever Spring (spiral)
210715	10796	Needle Vibrator Switch Return Lever Spring Rod
201528E	14158	Needle Vibrator Switch Return Lever Spring Rod Nut
228043	14163	Needle Vibrator Switch Return Lever Spring Washer
200325c	14163	Needle Vibrator Switch Return Lever Stop Screw (lower or up- per)
201518E	10755	Needle Vibrator Switch Return Lever Stop Screw (lower or up- per) Nut
207072	10759	Presser Bar Bushing (short)
200352c	10759	" " " Set Screw
202554	10759	" " Lifter
200653c	10759	" " Hinge Screw ...
210561	10759	" " Lifting Releasing Lev- er Bracket
200260D	10759	Presser Bar Lifting Releasing Lev- er Bracket Guide Screw
202342	10759	Presser Bar Lifting Releasing Lev- er Bracket Spring (spiral)
202337	10759	Presser Bar Position Guide
202338	10759	" " " " Lever with 200086F

No.	Plate	Name
200086F	10759	Presser Bar Position Guide Lever Pinch Screw
200352c	10759	Presser Bar Position Guide Set Screw
210758	10794	Presser Bar Spring
202346	10751	" " " Stop Rod
200492B	10759	" " Thumb Screw (pres- sure regulating)
200475B	10759	Presser Bar Thumb Screw Thumb Set Screw
202355	10759	Presser Bar Thumb Screw Thumb Set Screw Packing (brass)
201906	10748	Roller Presser, 1½ in. diam., ⅜ in. face (fine), with 200548c and 201534H
202839	10748	Roller Presser Arm
204567	—	" " " 202839 with 201906
202560	10748	Roller Presser Arm Bracket (swing)
210586	—	" " " " 202560 with 200077D, 202760, 204567, 229744 and 229745
200675c	10748	Roller Presser Arm Bracket Posi- tion Screw Stud
202558	10748	Roller Presser Arm Bracket Spring
229370	14163	" " " " " Stop and Back Needle Guard Holder
229371	10748	Roller Presser Arm Bracket Spring Stop and Back Needle Guard Holder 229370 with 200159F, 200350H and 226220
200350H	10748	Roller Presser Arm Bracket Spring Stop and Back Needle Guard Holder Adjusting Screw
200141F	10761	Roller Presser Arm Bracket Spring Stop and Back Needle Guard Holder Set Screw
200077D	10748	Roller Presser Arm Screw
229744	10748	" " " Shim, ⅜ in. thick
229745	10748	Roller Presser Arm Shim, ⅜ in. thick
202760	10748	Roller Presser Arm Shim, ⅜ in. thick
202557	10748	Roller Presser Bar (hollow), 8½ in. long
200548c	10748	Roller Presser Hinge Screw
201534H	10748	" " " " Nut ..
206510	14163	" " Needle Guard (back)

No.	Plate	Name
200159F	10748	Roller Presser Needle Guard (back) Clamp Screw
226220	10748	Roller Presser Needle Guard (back) Clamp Screw Washer
210688	—	Roller Presser and Bar complete, Nos. 200675c, 202557, 202558, 206510, 210586, 229371 and two 200141F
210591	10761	Take-up (auxiliary), for Swivel ..
200132E	10761	" " Screw
202398	10761	" Lever
202399	10761	" " Driving Stud with 202277
202277	—	Take-up Lever Driving Stud Oil Packing (wick)
202400	10761	Take-up Lever Hinge Stud with 202423
202423	—	Take-up Lever Hinge Stud Oil Packing (wick)
200383c	10755	Take-up Lever Hinge Stud Set Screw
202401	10761	Take-up Lever Oiling Felt
200132E	10761	" " " " Screw ..
202402	10762	Tension Disc (back)
202403	10762	" " (front)
202404	10762	" Release Plunger
202405	10762	" " Washer
202407	10881	" Spring
200625F	10762	" Stud with 204925
200061c	—	" " Set Screw
204925	13197	" " Washer
201572B	10881	" Thumb Nut
202409	10762	Tension complete, Nos. 200625F, 201572B, 202402, 202403, 202405, 202407 and 202410
202410	10762	Thread Controller Spring
202411	10762	" " " Stop
200132E	10761	" " " " Screw ..
210593	14163	" Guide (lower)
210594	10756	" " (on Needle Bar Frame)
200172H	10756	" " " " " Screw
210595	14161	Thread Guide (on side of Arm) ..
202412	10756	" " (on top of Arm)
210592	10756	" " (upper)
200582H	14161	" " Screw (2)
202091	10762	" Retainer Sleeve
202092	10762	" " Spring
204058	10762	" " Stud
200366H	10762	" " " Set Screw

No.	Plate	Name
204059	10762	Thread Retainer complete, Nos. 202091, 202092 and 204058
210605	10768	Throat Plate, 53 needle hole, for needle sizes 12 and 13
200577H	10755	Throat Plate Screw (2)

ACCESSORIES

FOR MACHINE No. 107w8

No.	Plate	Name
200157B	13178	Attachment Screw
210530	13174	Bobbin (5)
*225482	---	" Case Screw Driver Blade ..
*225483	---	" " " " Handle ..
225497	10776	Bobbin Case Screw Driver complete, Nos. 225482 and 225483 ..
231337	10776	Cloth Guide
135 x 9	---	Needles, six, size 18
225180	---	Drip Pan with four wood screws $\frac{3}{8}$ in., No. 5
41400	10776	Machine Rest Pin (wood)
36578	10776	Oiler with 36579
36579	10776	" Spout, 3 $\frac{1}{2}$ in. long, with 120117 ..
120117	---	" " Washer (leather)
*225484	---	Screw Driver Blade
*225485	---	" " Handle
225498	10776	Screw Driver complete (7 $\frac{1}{4}$ in. long), Nos. 225484 and 225485 ..
225554	10776	Wrench (steel)

BOBBIN WINDER

Swing Automatic, Right Hand

225453	10884	Frame with 202277 and 225438
225454	10884	" Hinge Pin
202277	---	" Oil Packing (wick)
225438	10884	" " Well Cap
225455	10884	" Spring
225456	10884	" " Plunger
202473	10885	Pulley with 200105c
200105c	10884	" Set Screw
225381	10884	Spindle
225444	10884	Stop Latch
200056E	10884	" " Screw
225458	10884	" " Thumb Lever
225459	10884	" " " " Hinge Stud ..
225460	10884	" " " " Joint Stud ..
202478	10884	" " Trip Lever
200299H	10884	" " " " Hinge Screw ..
225461	10881	Tension Bracket with 201499B
200082D	10881	" " Screw

No.	Plate	Name
228026	10884	Tension Bracket Screw Washer ...
2102	10881	" Disc
202407	10881	" Spring
201499B	10881	" Stud
201572B	10881	" " Thumb Nut
225462	10881	Bobbin Winder Tension Bracket complete, Nos. 201572B, 202407, 225461 and two 2102
225433	10885	Bobbin Winder and Tension Bracket Base
225382	10885	Universal Bobbin Winder complete, Nos. 200056E, 200082D, 290299H, 202473, 202478, 225381, 225433, 225444, 225453 to 225456, 225458 to 225460, 225462, 228026 and two wood screws $\frac{3}{4}$ in., No. 13, R.H.B.

KNEE LIFTER

227781	10958	Knee Lifter Rock Lever with 200522c and 200529c
227782	----	Knee Lifter Rock Lever 227781 with two each 202451 and 202452
227783	10958	Knee Lifter Rock Lever 227782 with 202985 and 227784
202453	10958	Knee Lifter Rock Lever Knee Plate with 200526c
202985	----	Knee Lifter Rock Lever Knee Plate 202453 with 202455
202455	10958	Knee Lifter Rock Lever Knee Plate Arm (short)
200522c	13178	Knee Lifter Rock Lever Knee Plate Arm Set Screw
200526c	13178	Knee Lifter Rock Lever Knee Plate Set Screw
202451	10958	Knee Lifter Rock Lever Lug with two wood screws $\frac{3}{4}$ in., No. 13H
202452	13178	Knee Lifter Rock Lever Lug Hinge Pin
227784	10958	Knee Lifter Rock Lever Rod, 3 in. long, with 227785
*227785	----	Knee Lifter Rock Lever Rod Cap or Oil Guard
200529c	13178	Knee Lifter Rock Lever Rod Set Screw

(Other Knee Lifter parts are listed with parts of machine head).

FOR MACHINE No. 107w9

Same as for Machine No. 107w8 with the following exceptions:

No.	Plate	Name
135 x9	----	Needles, six, size 14, in place of size 18
(200157		Attachment Screw, 231337 Cloth Guide, not used)

FOR MACHINE No. 107w10

Same as for Machine No. 107w8 with the following exception:

135 x5	----	Needles, six, size 16, in place of 135x9, size 18
--------	------	---

FOR MACHINE No. 107w11

Same as for Machine No. 107w8 with the following exceptions:

225487	14163	Roller Presser Hinge Screw Nut Wrench
135 x8	----	Needles, six, size 16, in place of 135x9, size 18

TREADLE, SINGLE FOOT (RIGHT)

No.	Plate	Name
227610	10797	Treadle with 200526c
227779	10797	" Chain, 48 in. long, with two 202784
227612	10797	Treadle Chain Eye Pin
202784	14163	" " " " Hook ...
200526c	13178	" " " " Set Screw
227613	10796	" Shaft
227614	10796	" Spring
227615	10797	" Stand with four wood screws ¾ in., No. 13, F.H.B.
227616	—	Treadle, single foot (right) and Stand complete, Nos. 227610, 227612 to 227615 and 227779 ...

FEED DOGS

210518	14165	Feed Dog, for 210600
210524	14166	" " " 210604, to be used with 226883
235253	14166	Feed Dog, for 235255 and 235260, to be used with 120009
210517	14165	Feed Dog, for 210597
210525	10768	" " " 210605

PRESSER FEET

No.	Plate	Name
235220	14164	Presser Foot, for Machine No. 107w8
210680	14165	Presser Foot, to be used with 226883, for Machine No. 107w9..
235254	14165	Presser Foot, to be used with 120009, for Machine No. 107w9..
235258	14164	Presser Foot, for Machine No. 107w9
235259	14165	Presser Foot, for Machine No. 107w9
210689	14164	Presser Foot (left) with 200172H and 210691
210690	14164	Presser Foot (right)
210570	14164	" " Bracket
210571	14164	" " Guide with 200141R..
200141R	10761	" " " Screw
210574	14164	" " Spring
202512	14164	" " Stop Pin
210691	14164	" " Thread Draw
200172H	10756	" " " " Screw..
210692	14164	Presser Foot (compensating) com- plete, Nos. 210570, 210689, 210690, two each 202512, 210571 and 210574, for Machine No. 107w10

THROAT PLATES

No.	Plate	Name
210600	14165	Throat Plate, 53 needle hole, for needle sizes 12 and 13, for 210518, for Machine No. 107w8
210604	14166	Throat Plate, 53 needle hole, for needle sizes 12 and 13, for 210524, to be used with 226883, for Machine No. 107w9
235255	14166	Throat Plate, 56 needle hole, for needle sizes 10 and 11, for 235253, to be used with 120009, for Machine No. 107w9
235260	14166	Throat Plate, 56 needle hole, for needle sizes 10 and 11, for 235253, for Machine No. 107w9
210597	14165	Throat Plate, 53 needle hole, for needle sizes 12 and 13, for 210517, for Machine No. 107w10
210605	10768	Throat Plate, 53 needle hole, for needle sizes 12 and 13, for 210525, for Machine No. 107w11

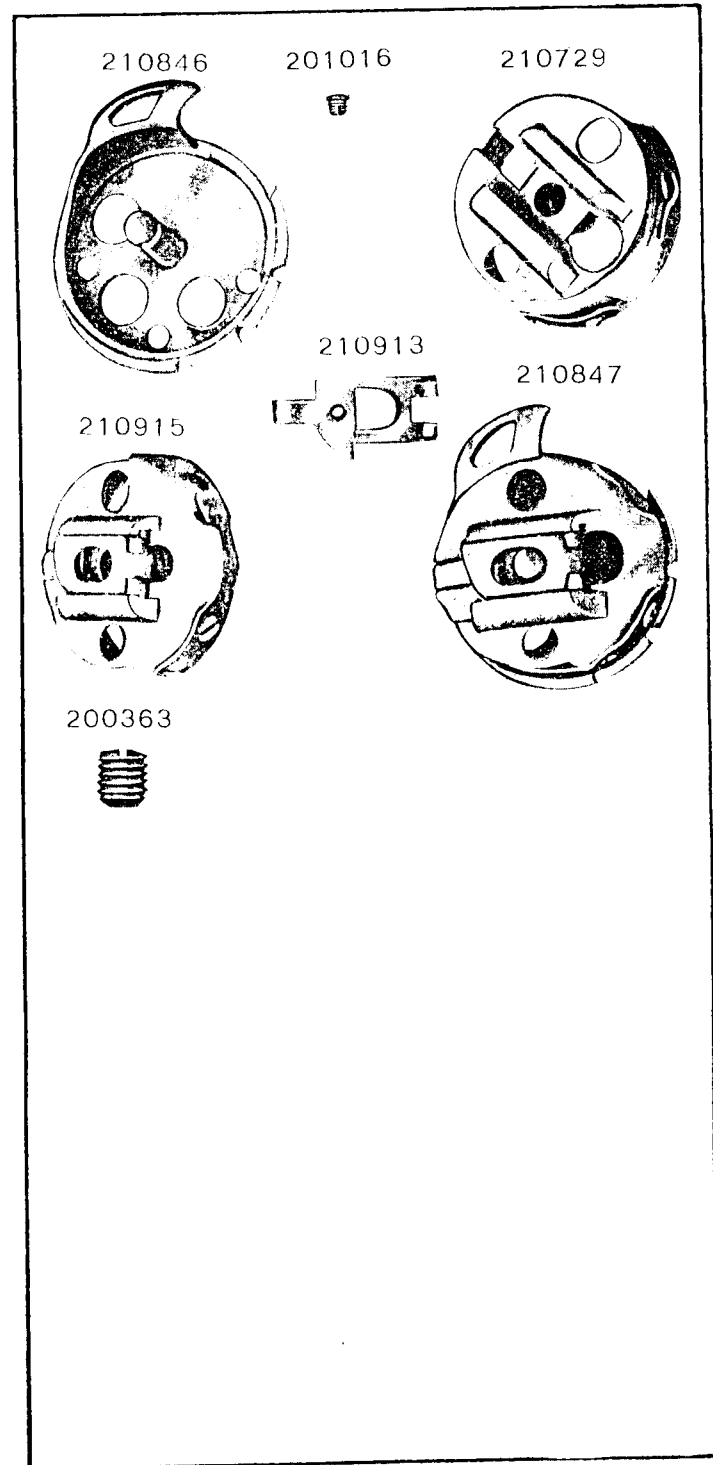

PLATE 10748-FULL SIZE

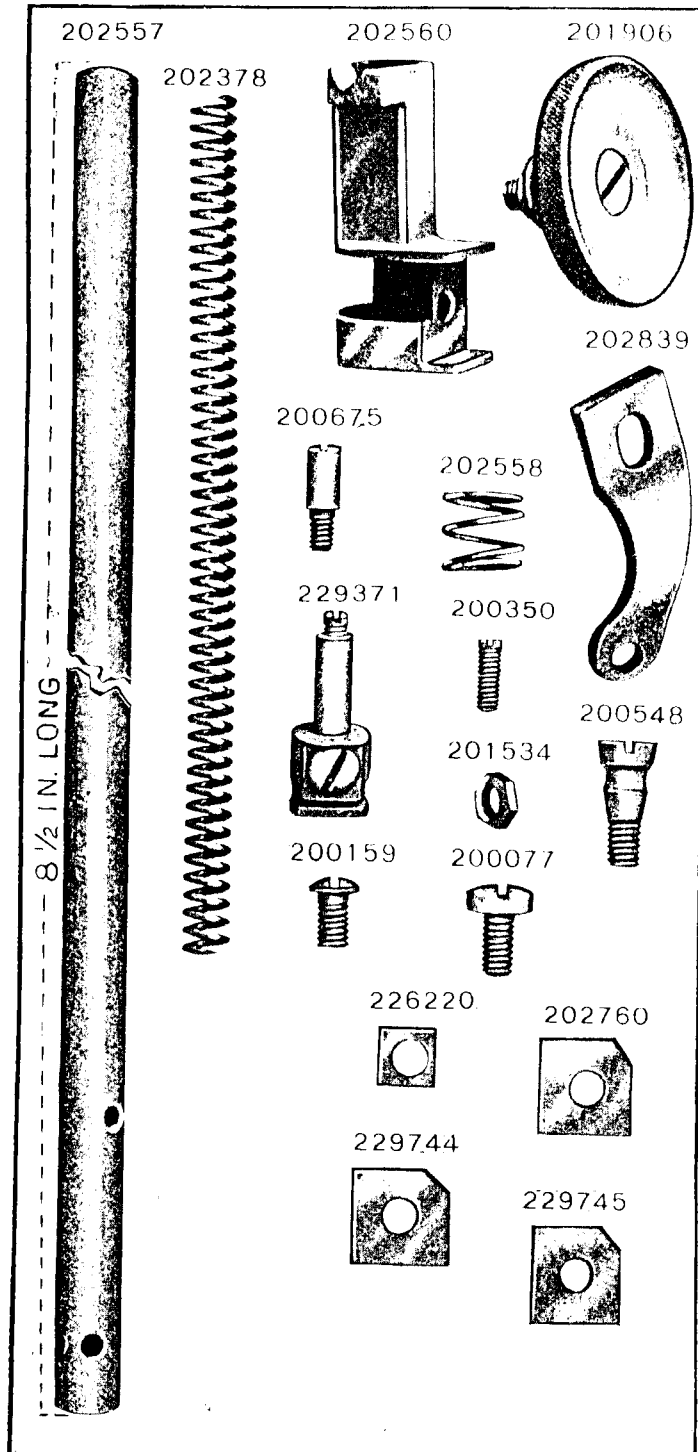

PLATE 10751-ONE-HALF SIZE

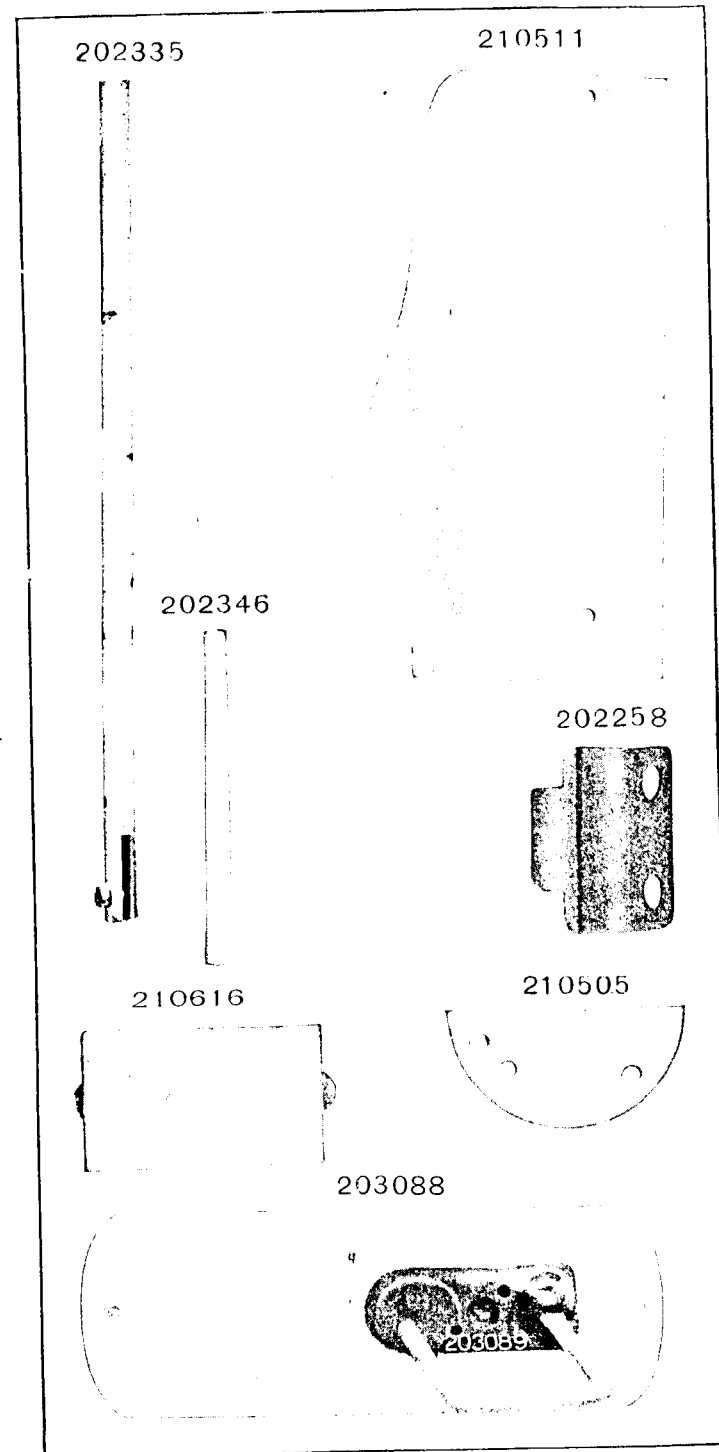

PLATE 10752—ONE-HALF SIZE

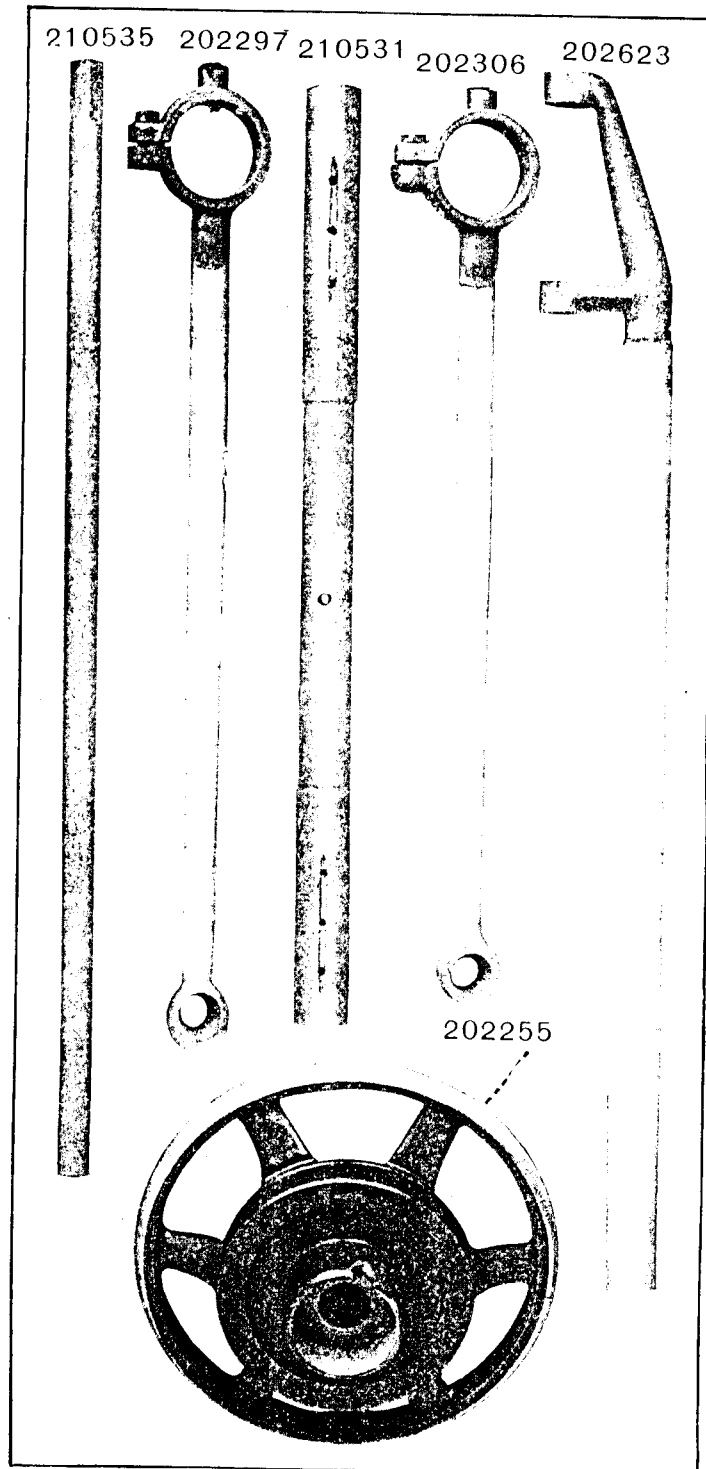

PLATE 10753—ONE-HALF SIZE

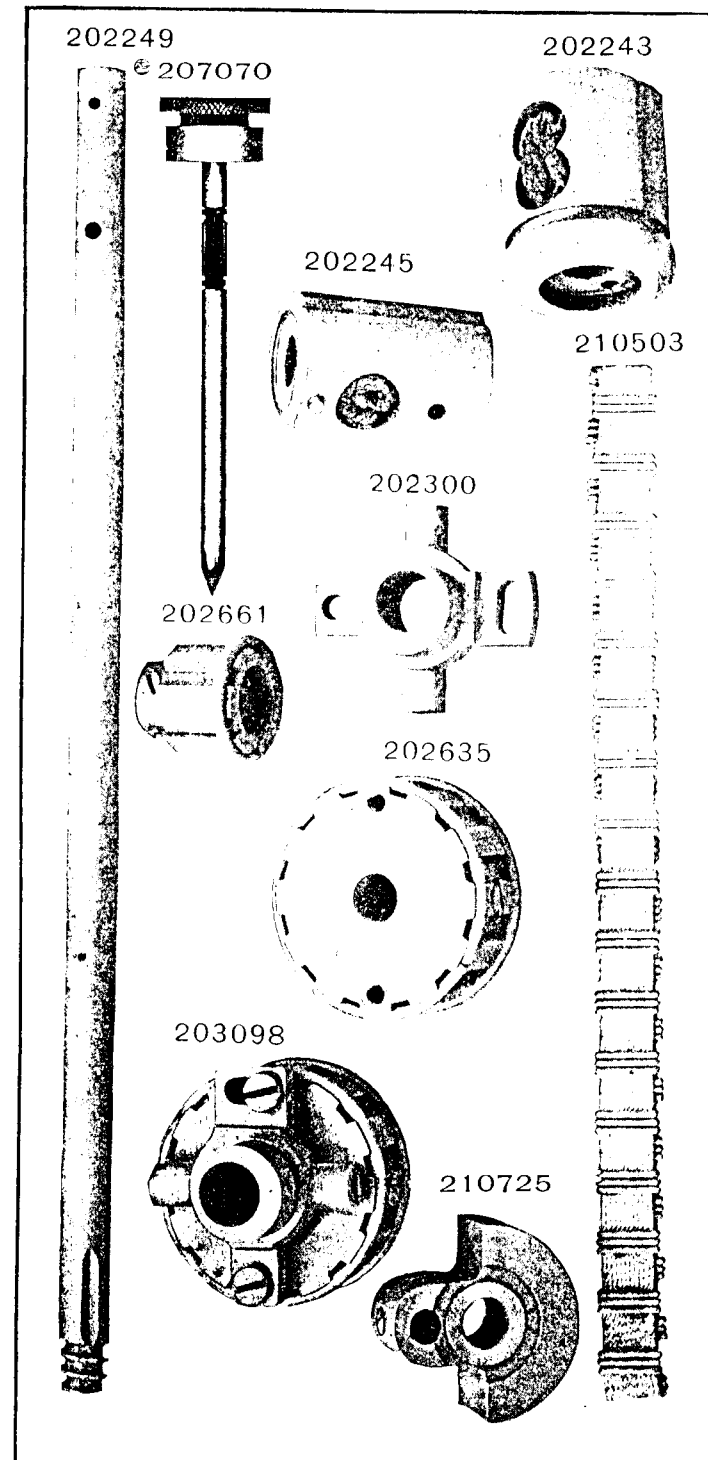

PLATE 10755—FULL SIZE

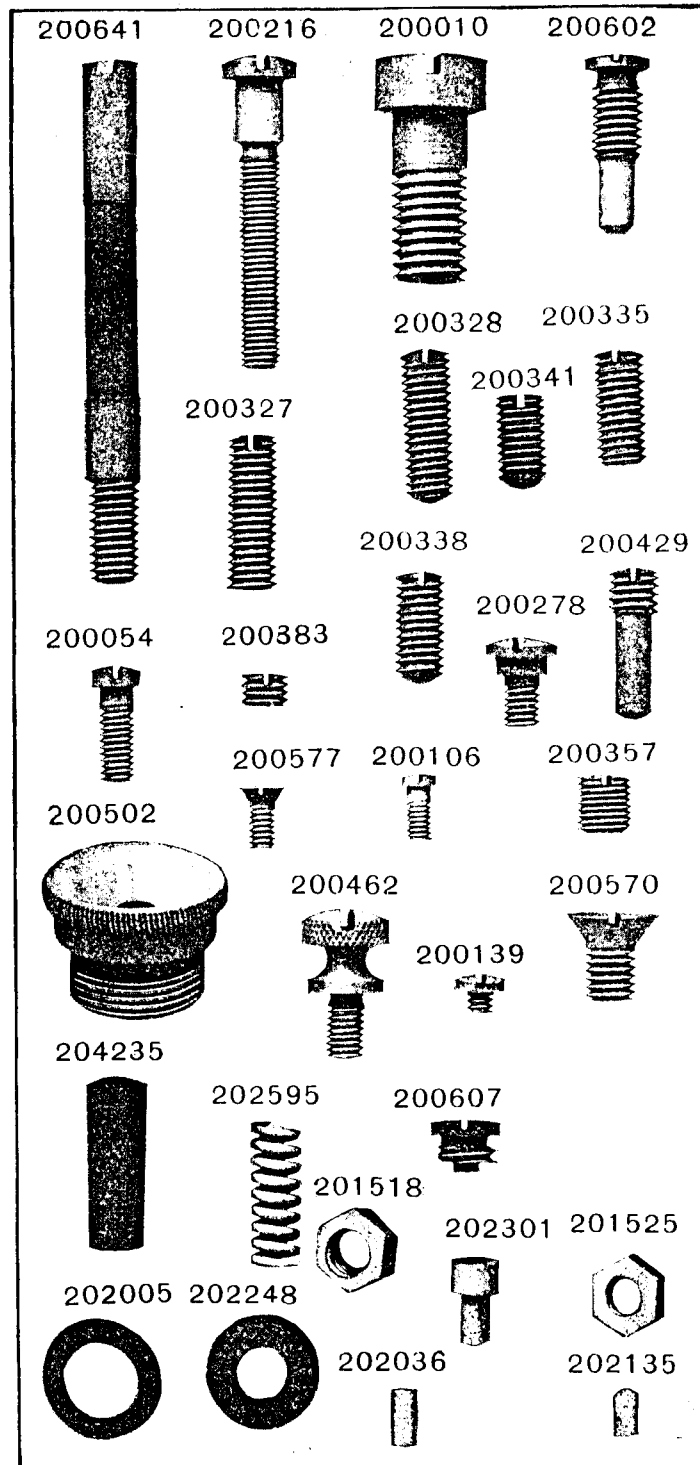

PLATE 10756—FULL SIZE

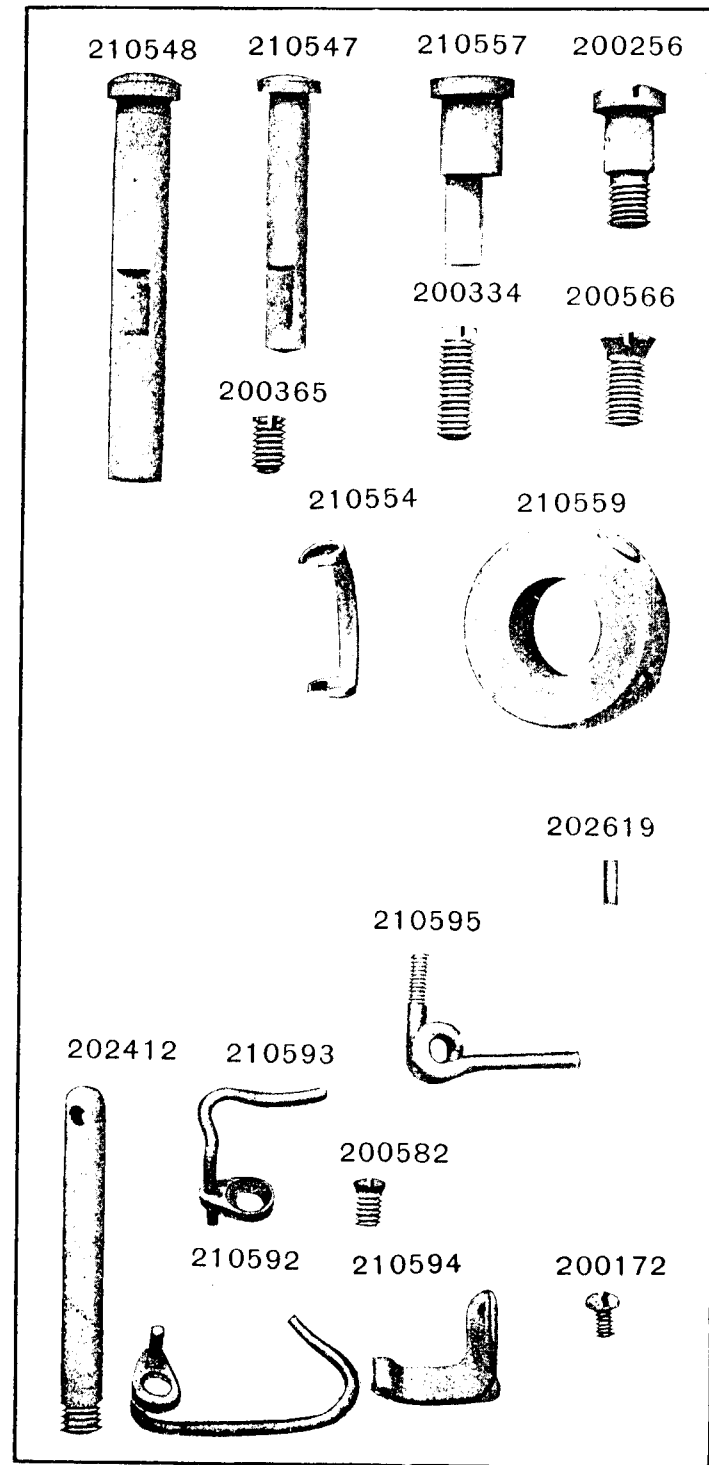

PLATE 10757—FULL SIZE

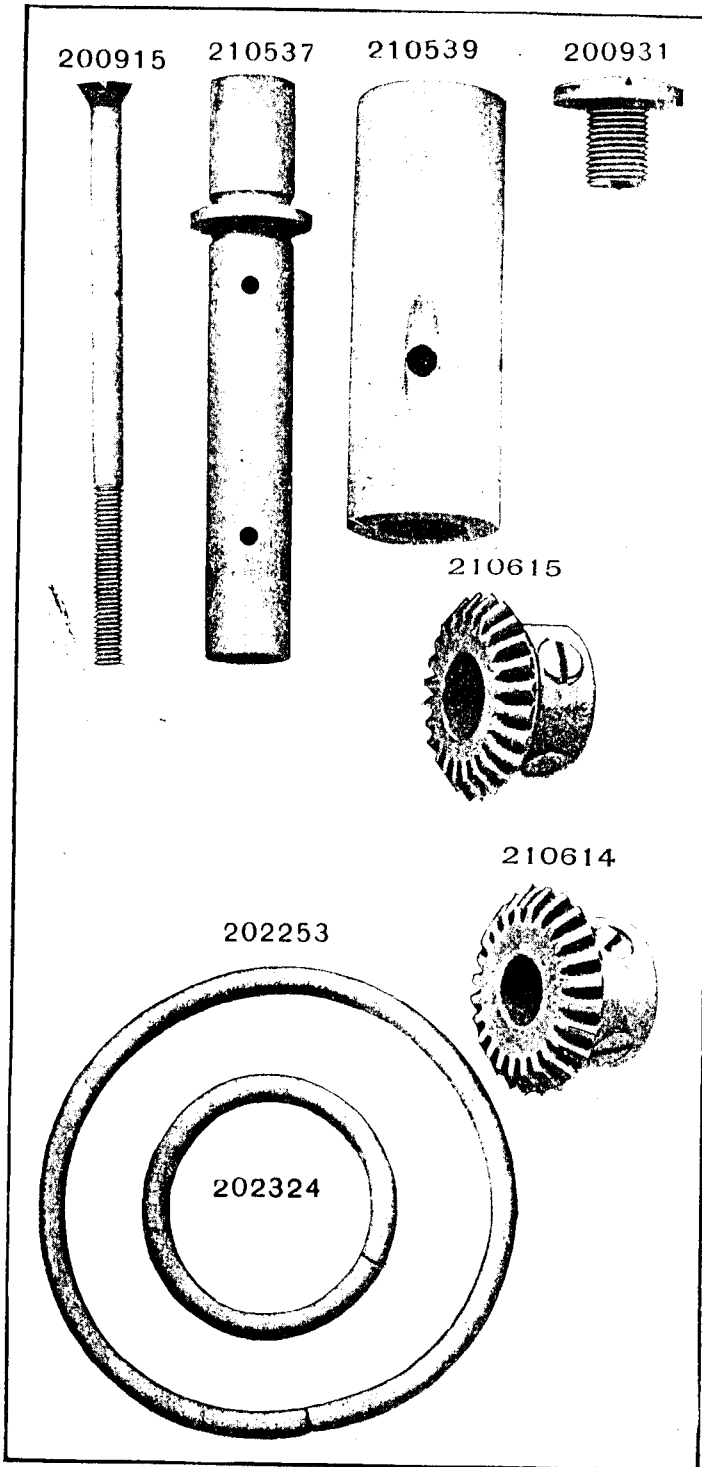

PLATE 10759—FULL SIZE

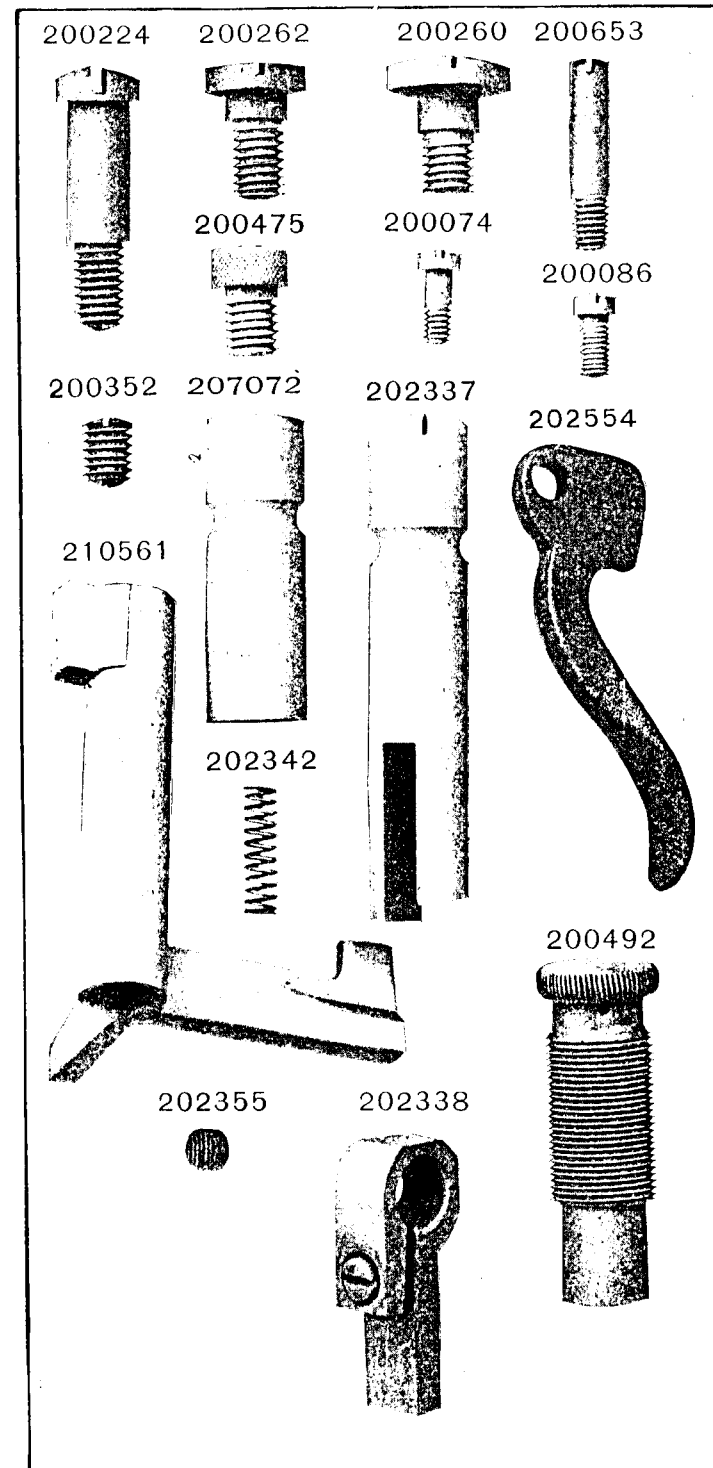

PLATE 10760—FULL SIZE

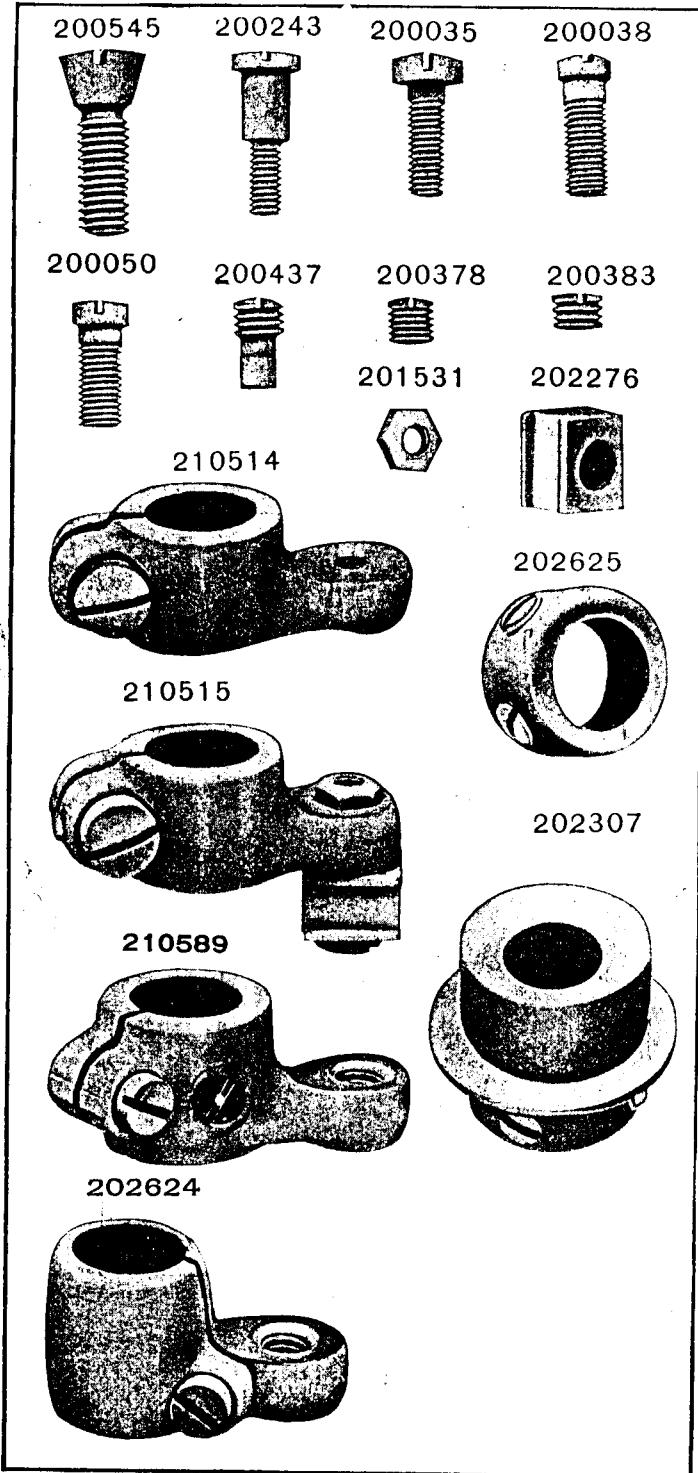

PLATE 10761—FULL SIZE

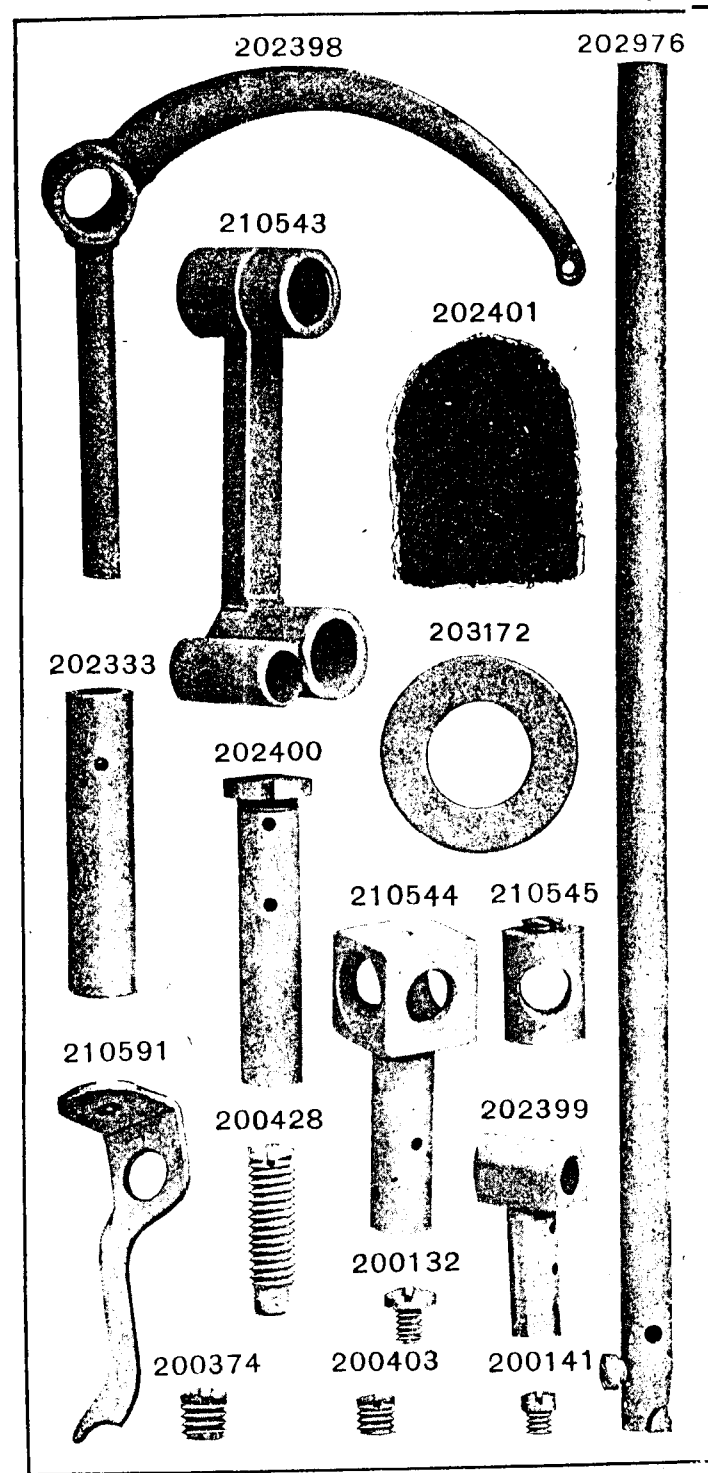

PLATE 10762—FULL SIZE

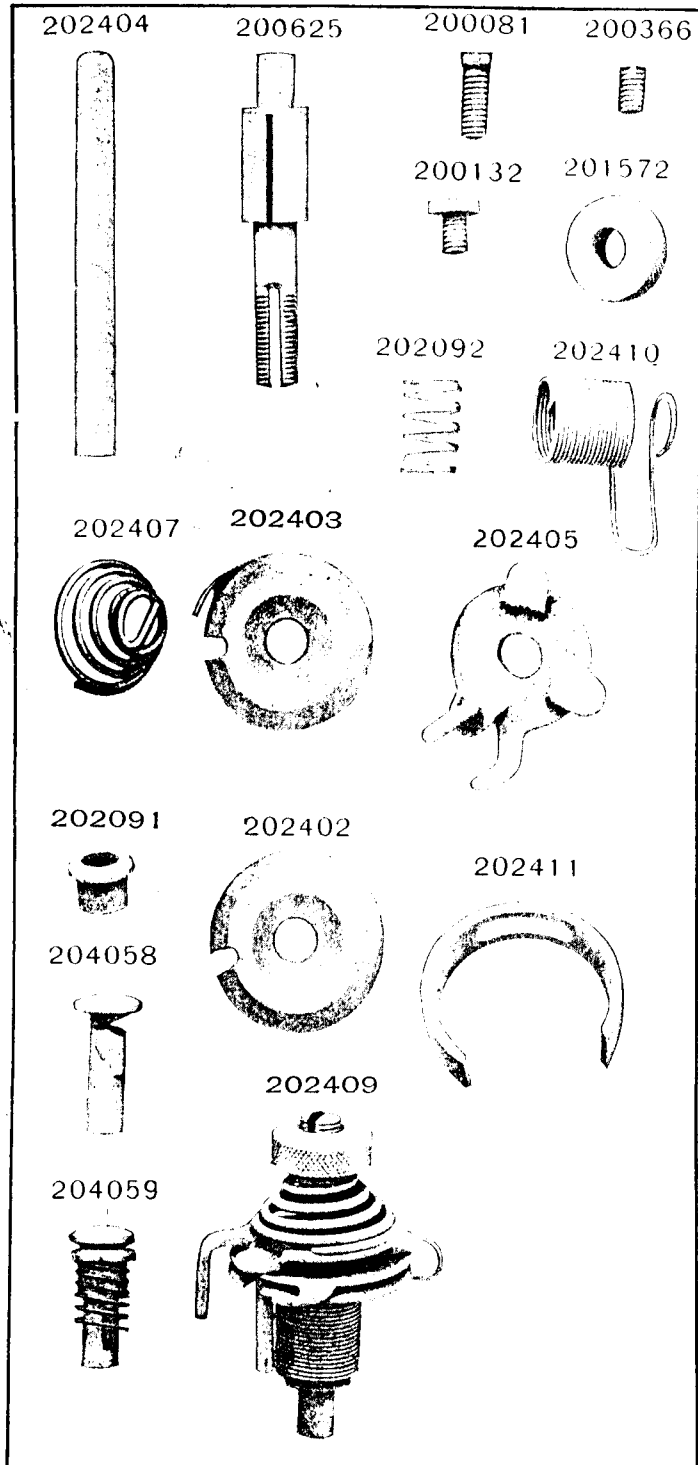

PLATE 10768—FULL SIZE

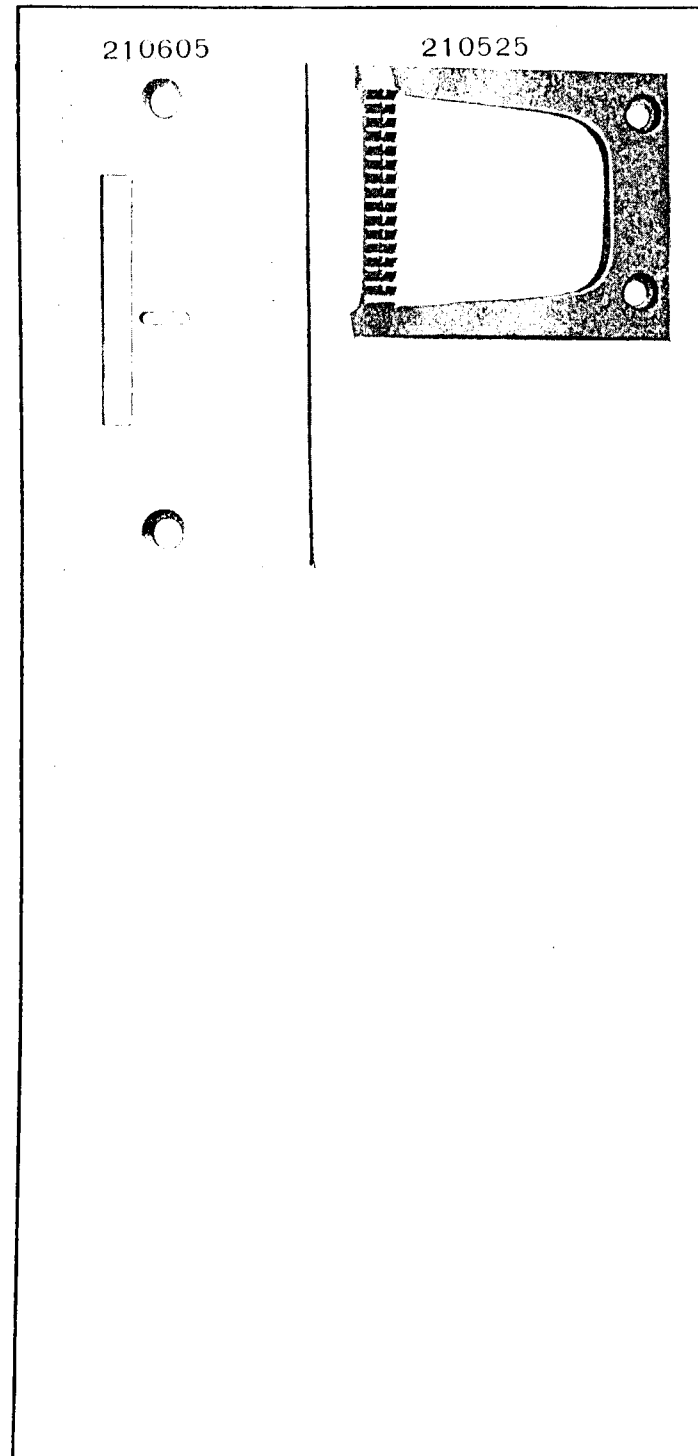

PLATE 10776—ONE-HALF SIZE

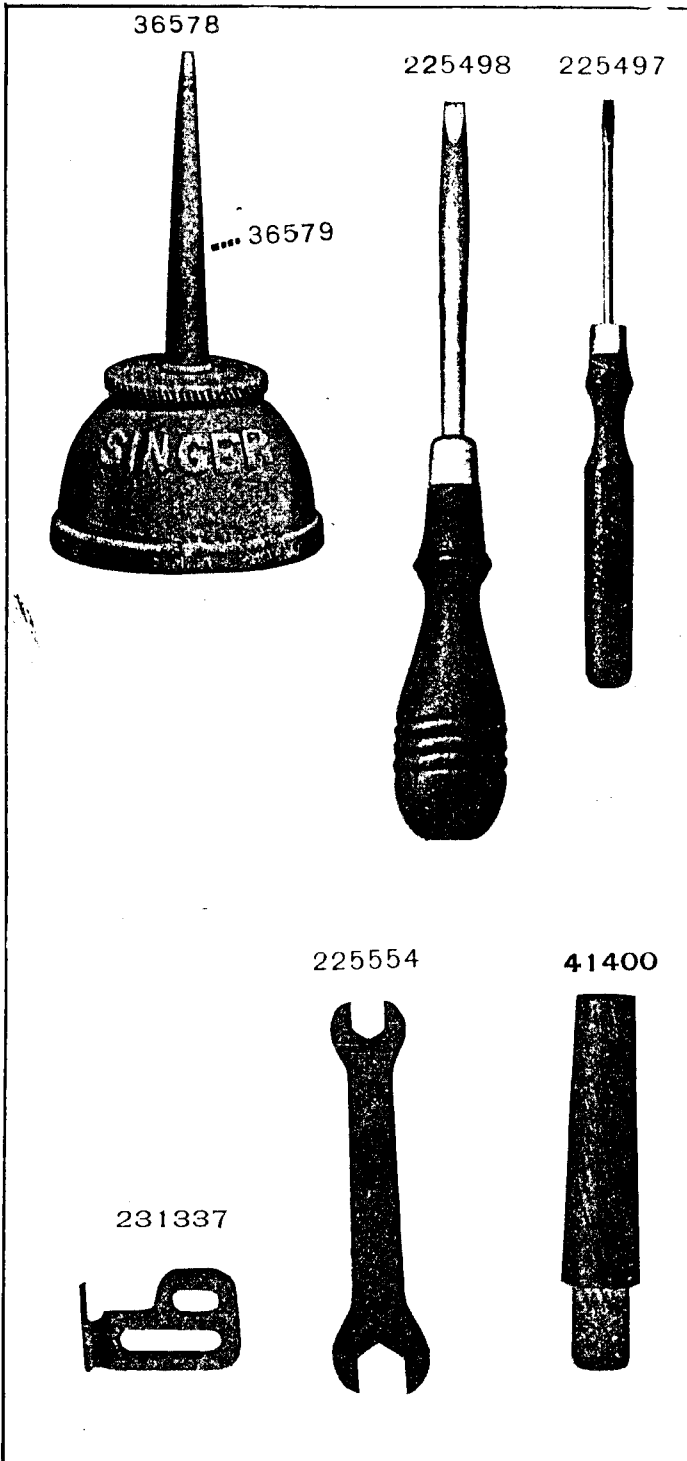

PLATE 10794—FULL SIZE

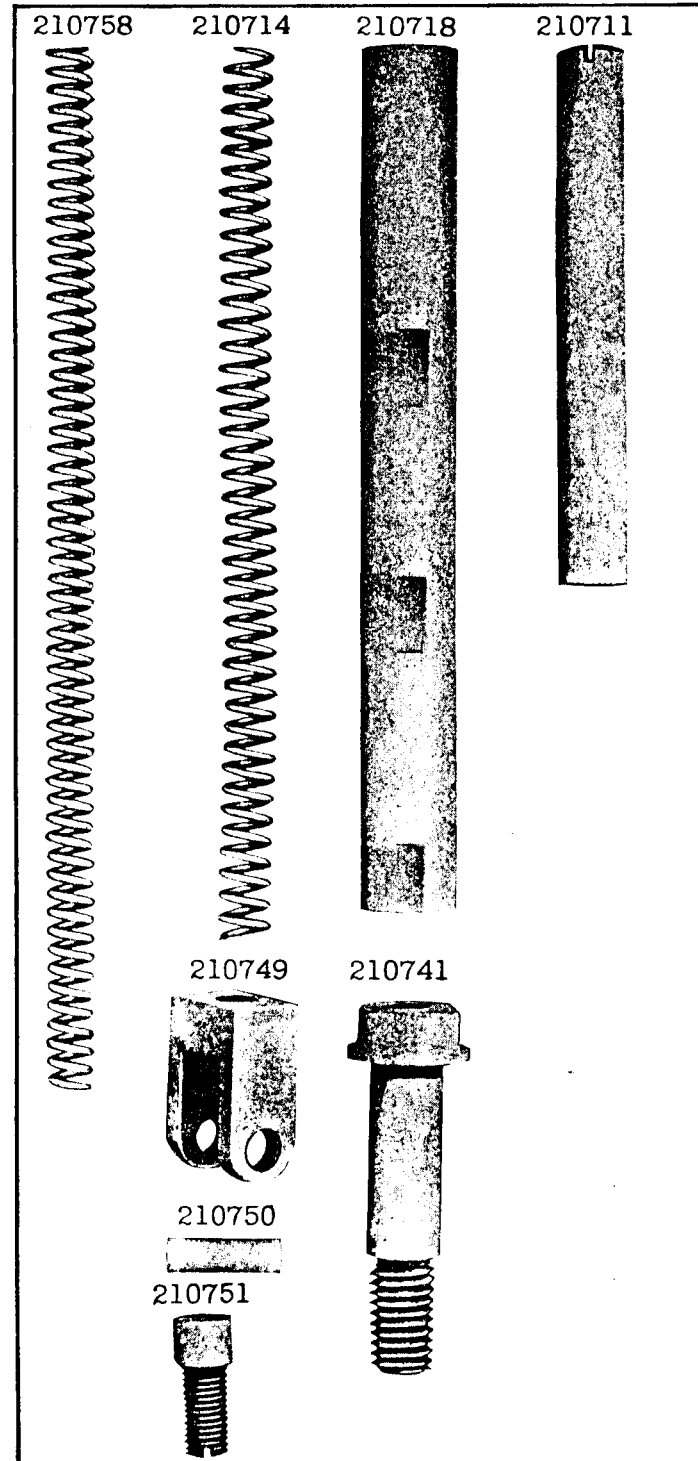

PLATE 10795—ONE-HALF SIZE

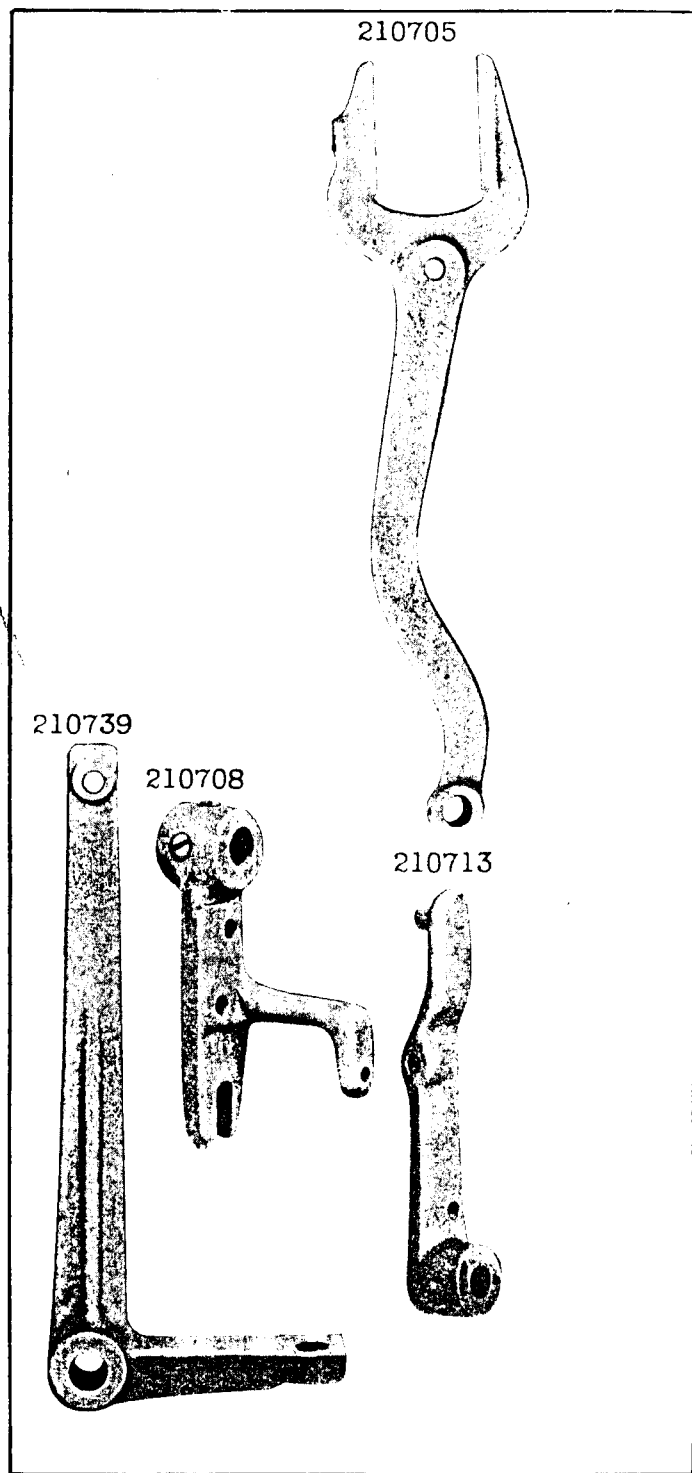

PLATE 10796—ONE-HALF SIZE

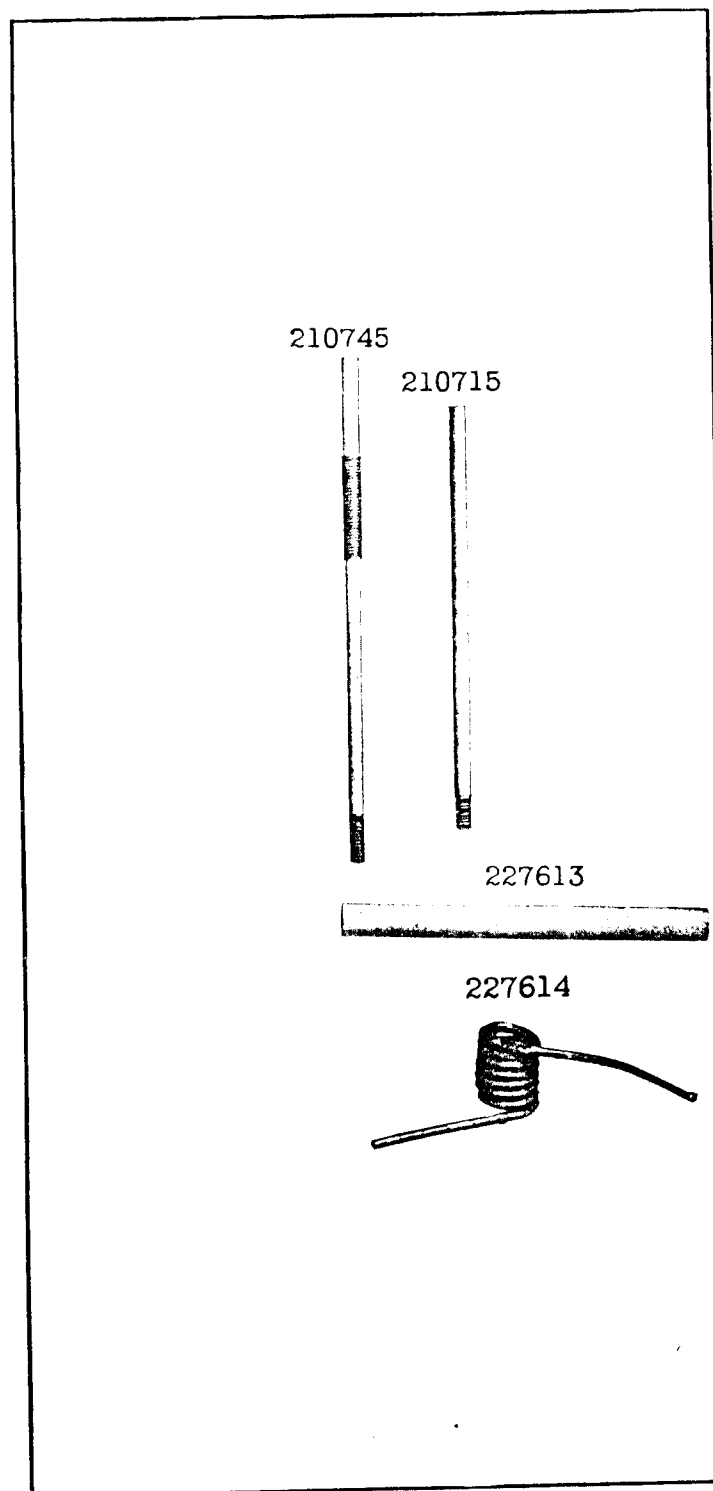

PLATE 10797—ONE-HALF SIZE

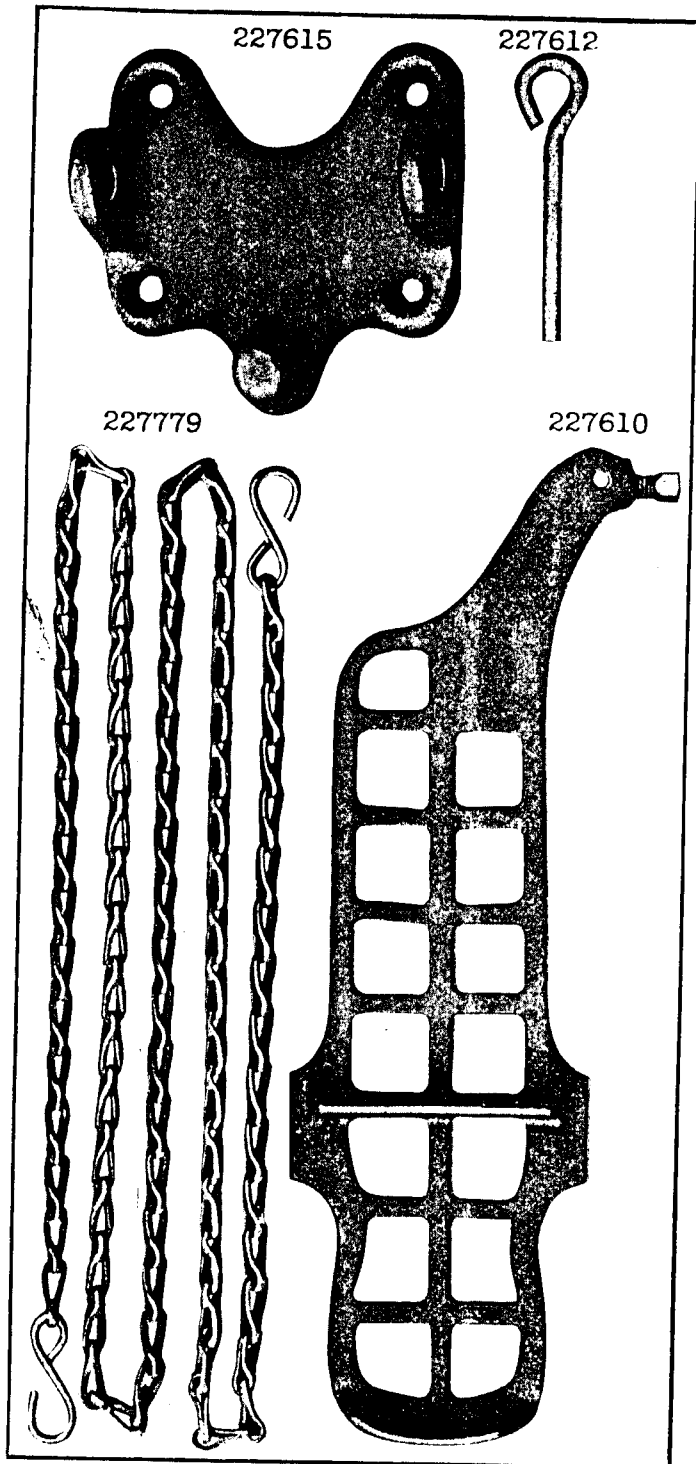

PLATE 10881—FULL SIZE

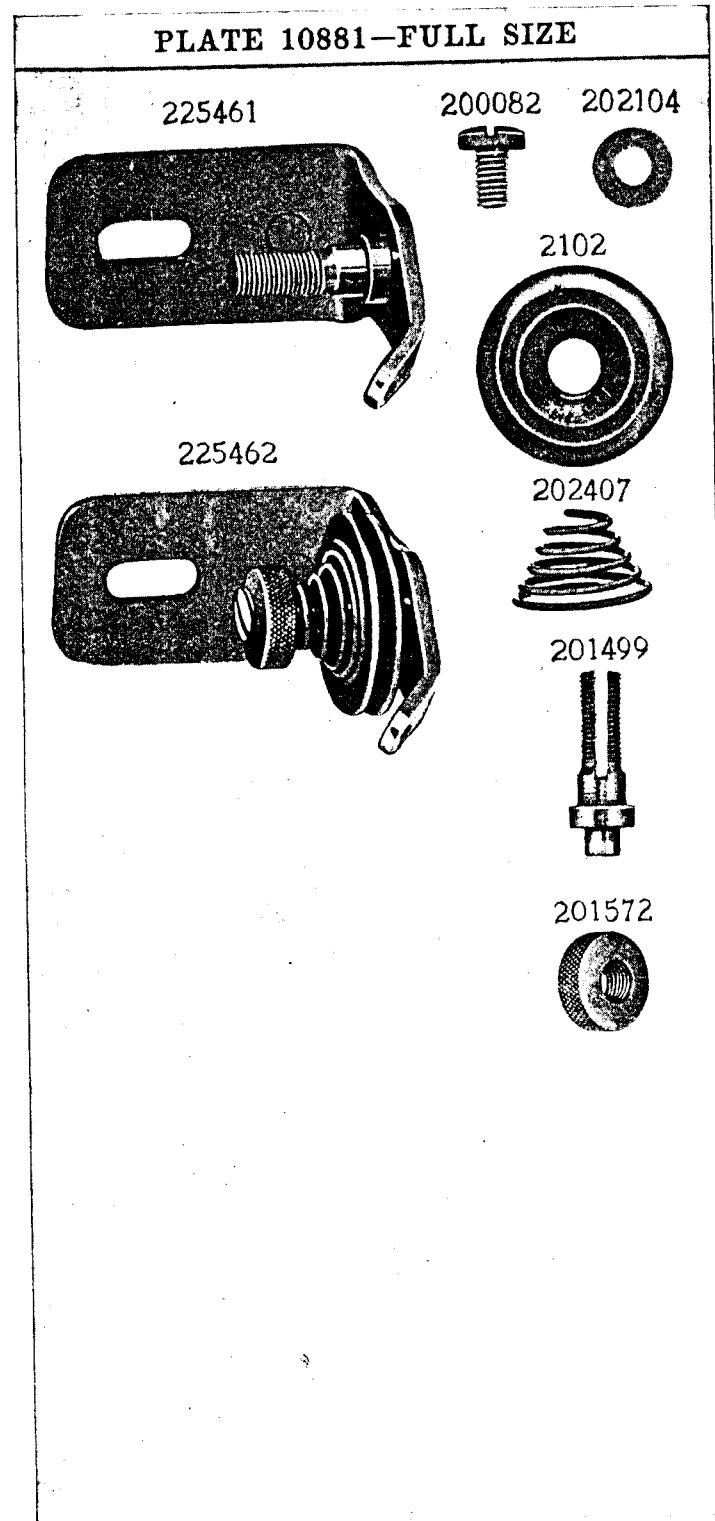

PLATE 10884—FULL SIZE

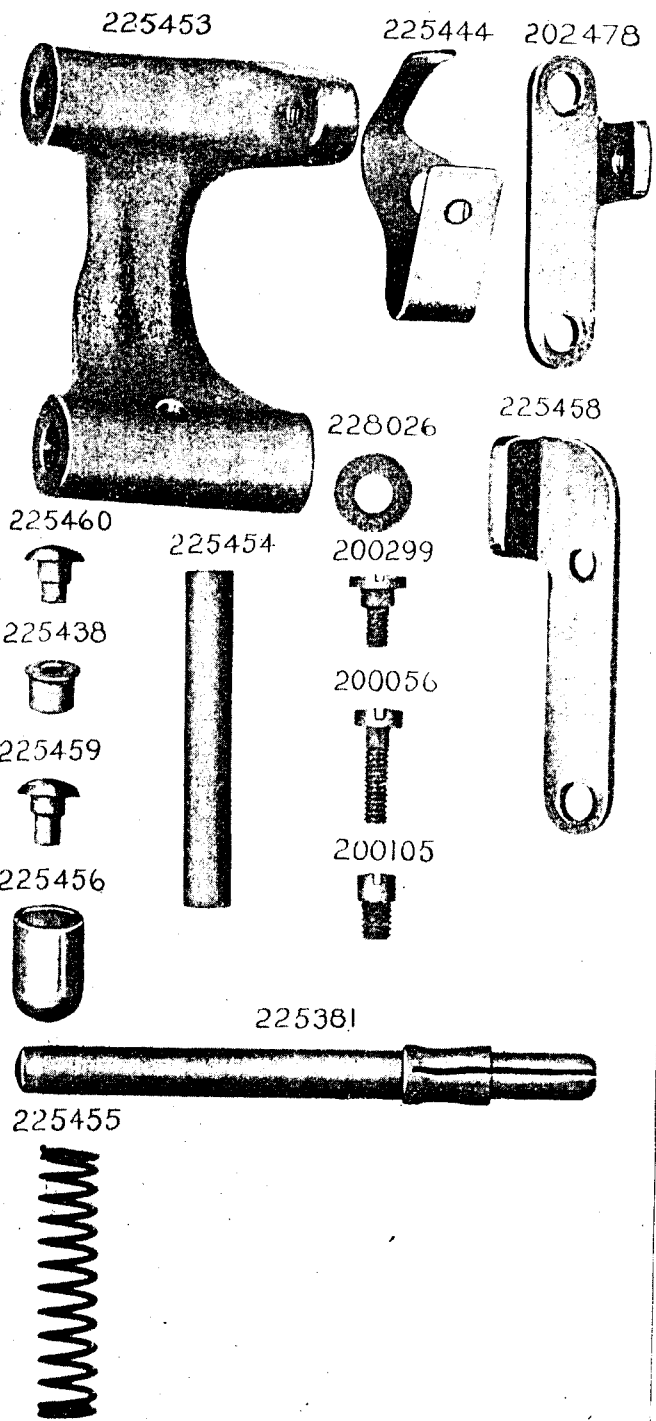

PLATE 10885—ONE-FOURTH SIZE

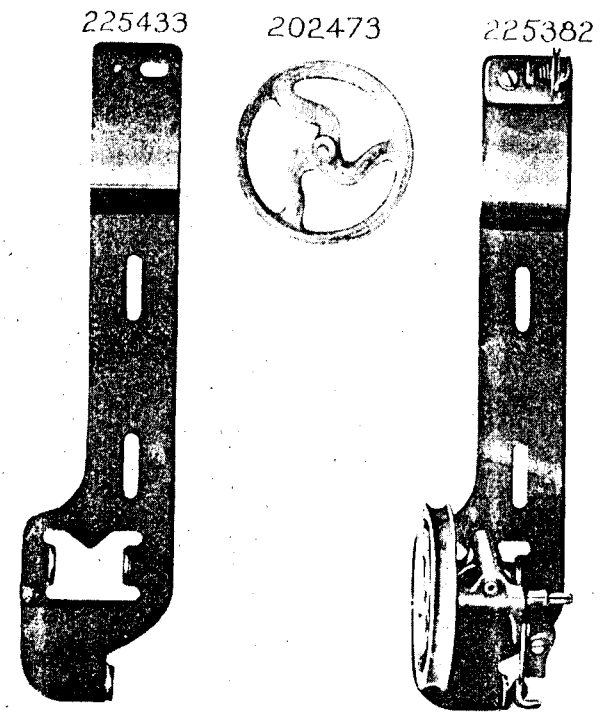

PLATE 10958—ONE-FOURTH SIZE

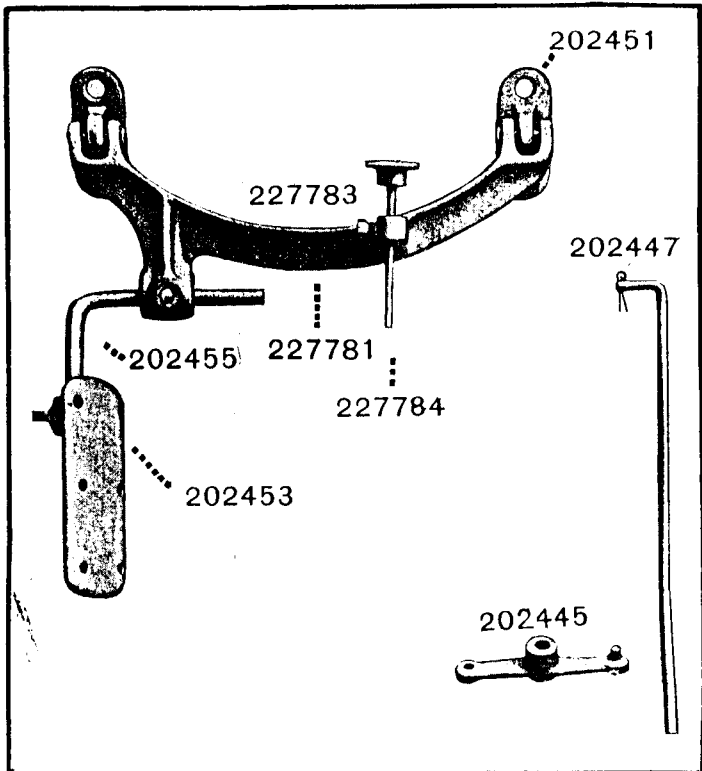

PLATE 13174—FULL SIZE

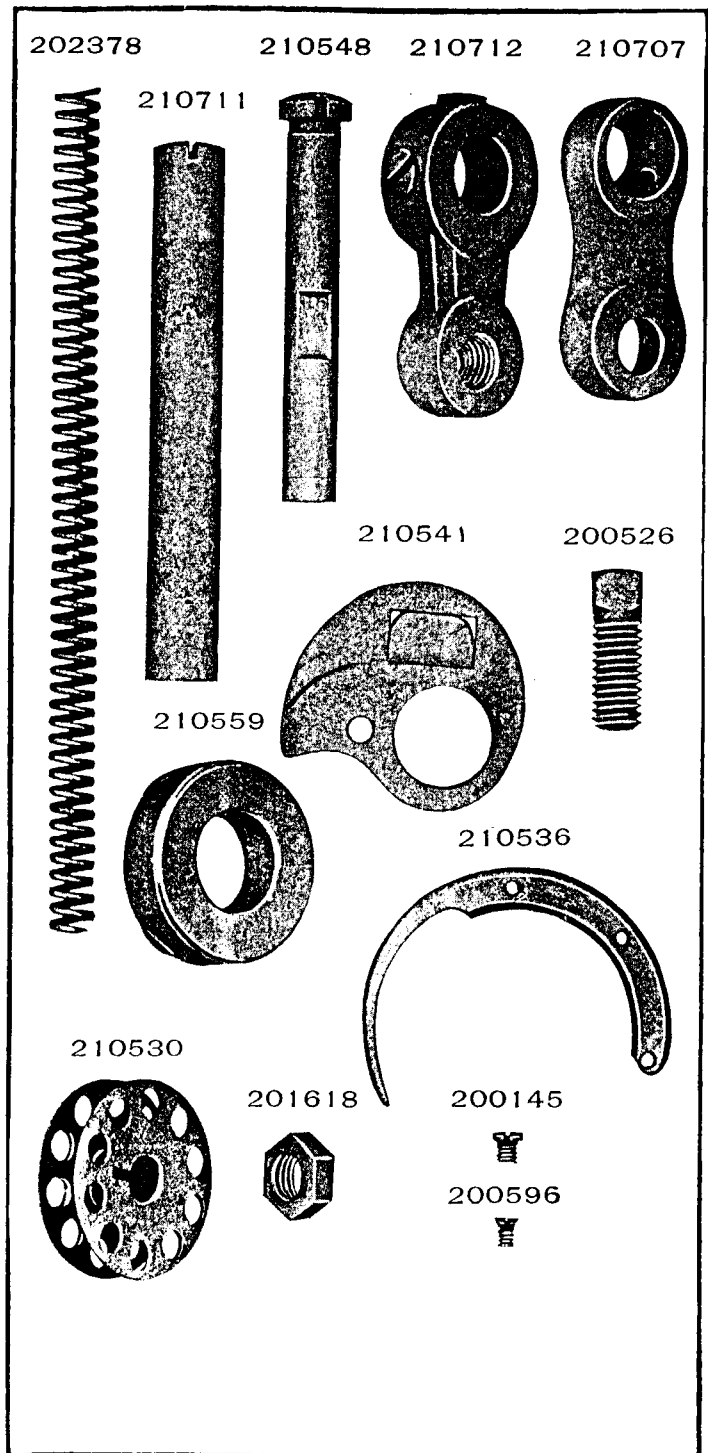

PLATE 13178-FULL SIZE

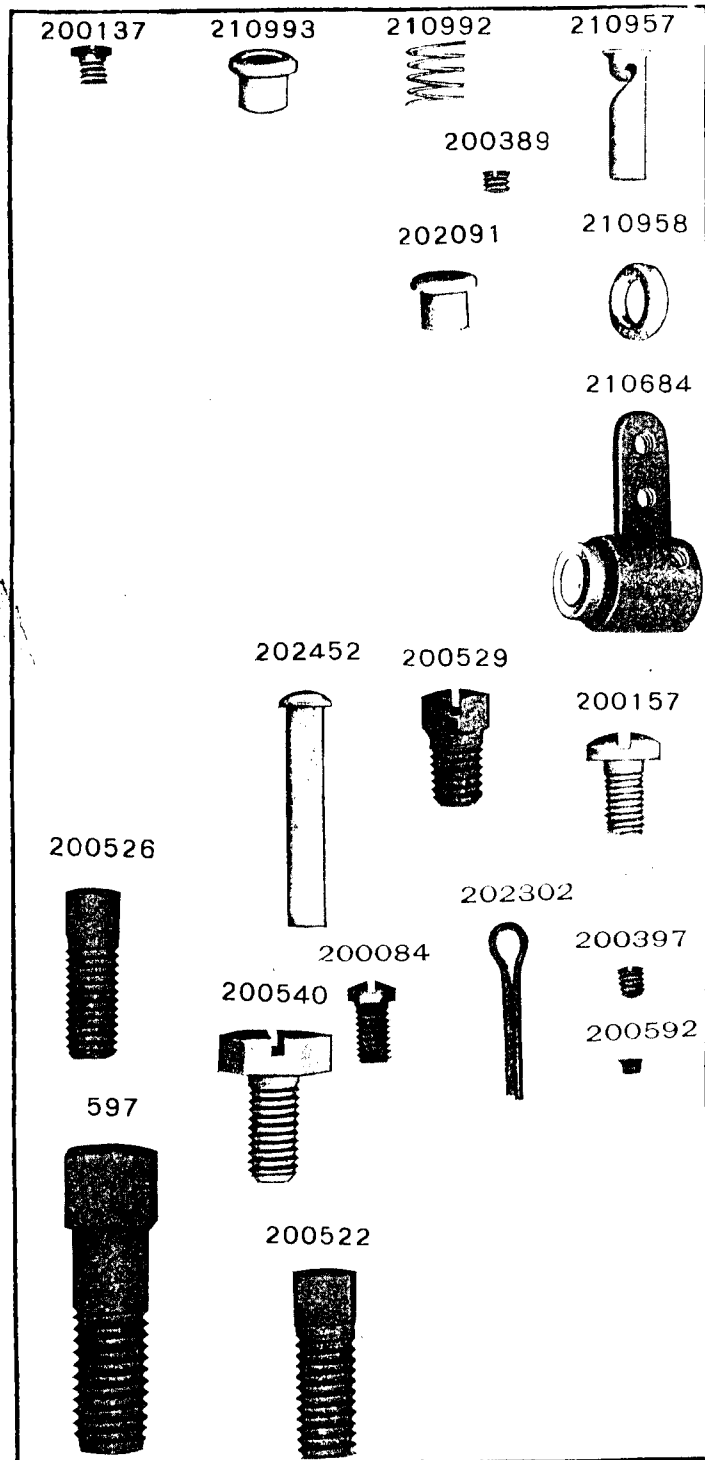

PLATE 13197-FULL SIZE

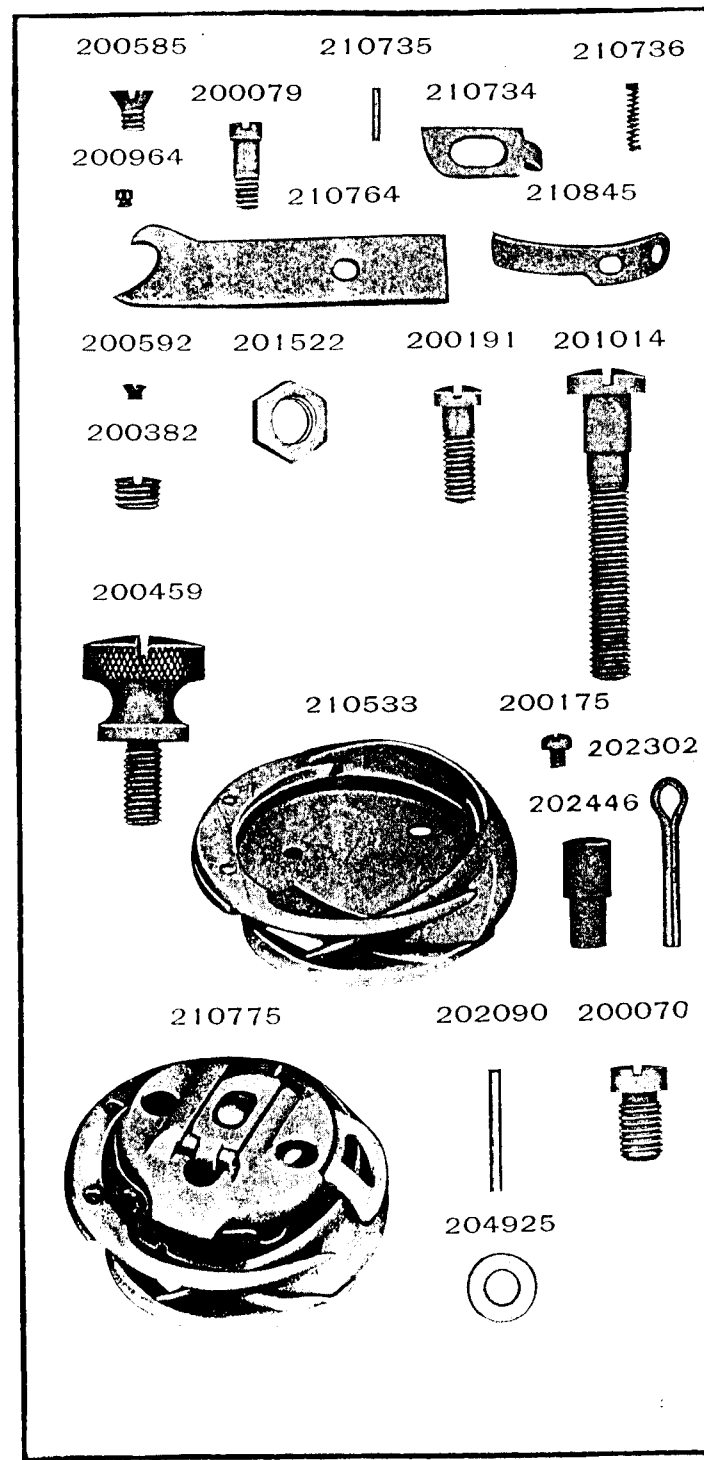

PLATE 13199—FULL SIZE

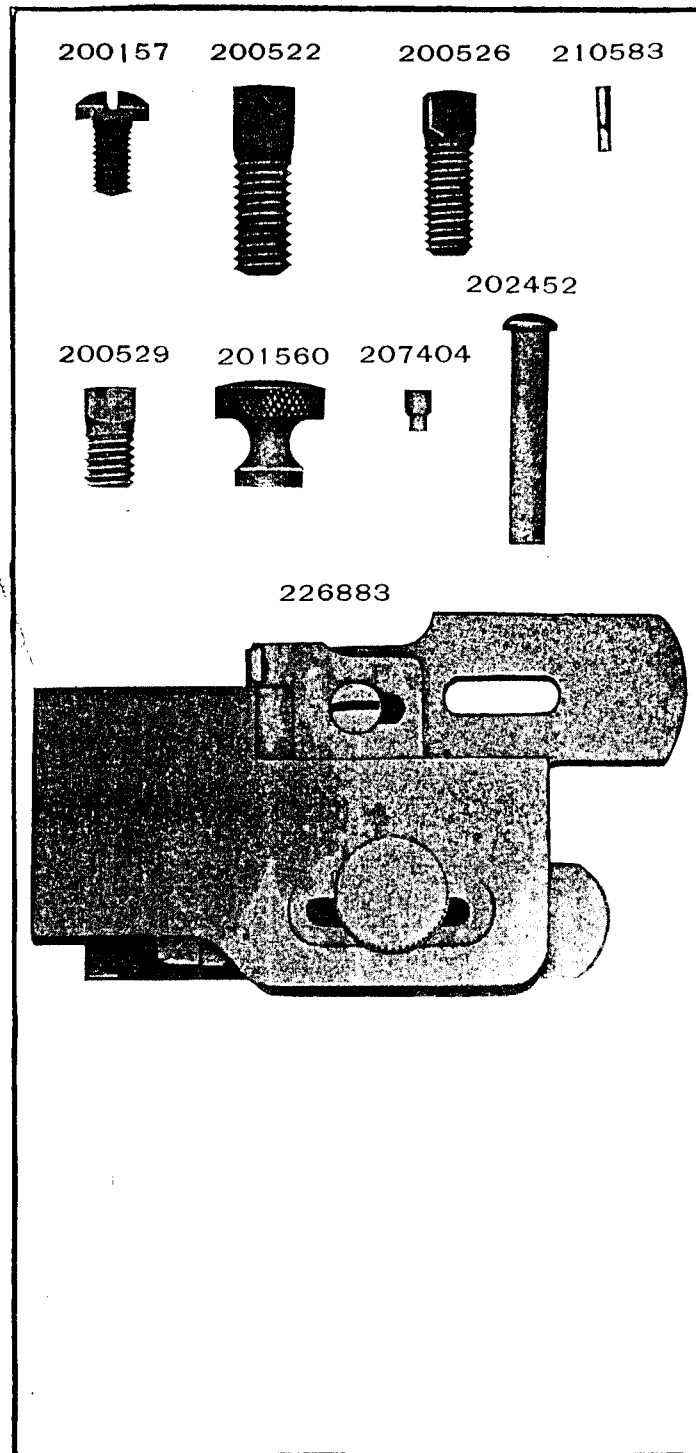

PLATE 14158—FULL SIZE

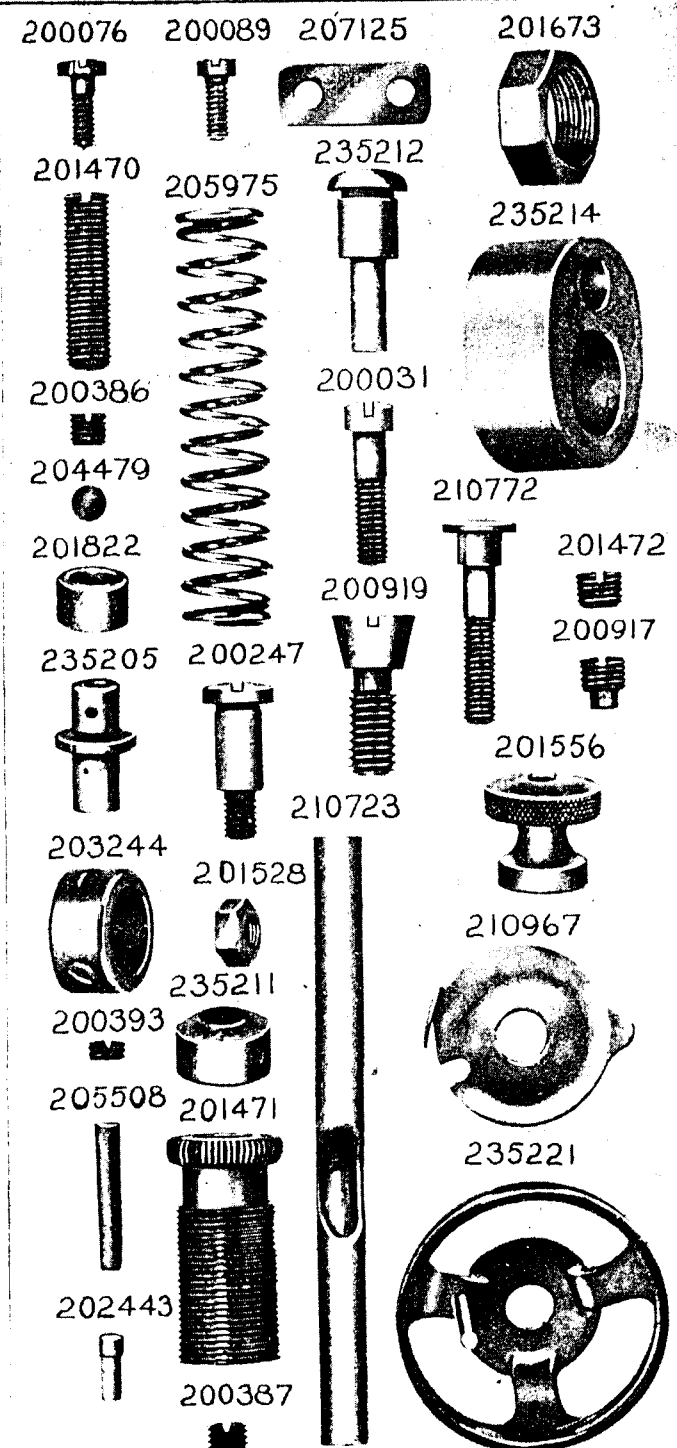
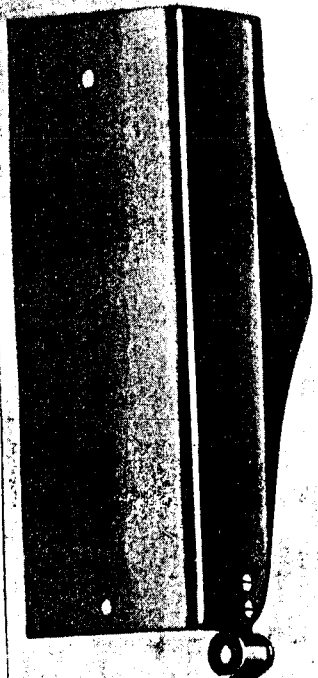

PLATE 14159—ONE-HALF SIZE

210682



210512



235204

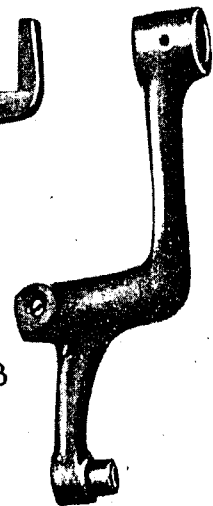

235203



235206



235202

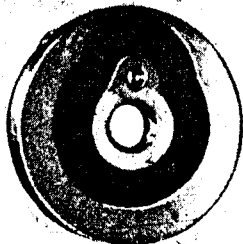

450

202449

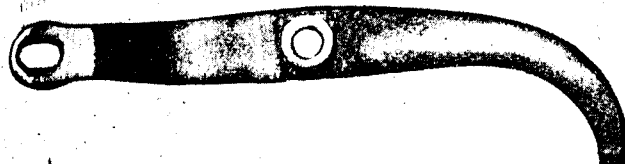
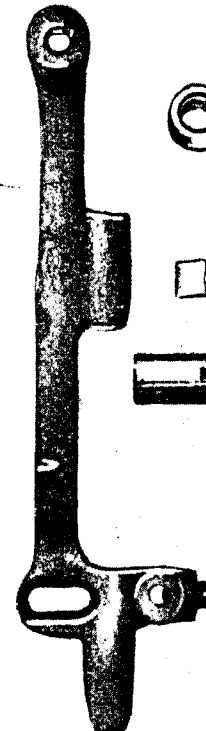

PLATE 14160—ONE-HALF SIZE

210546



235208



235209

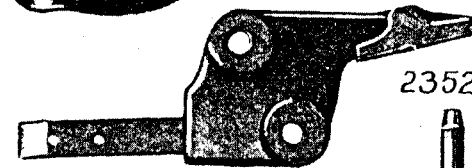

235210



235215



210551

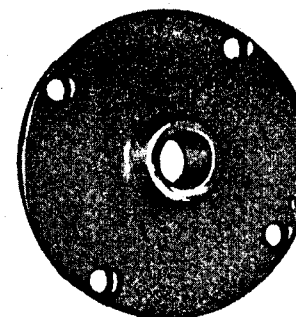

235216

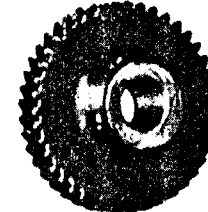

210770



235219



235218



235252

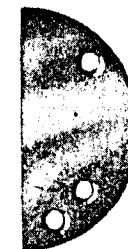

PLATE 14161—FULL SIZE

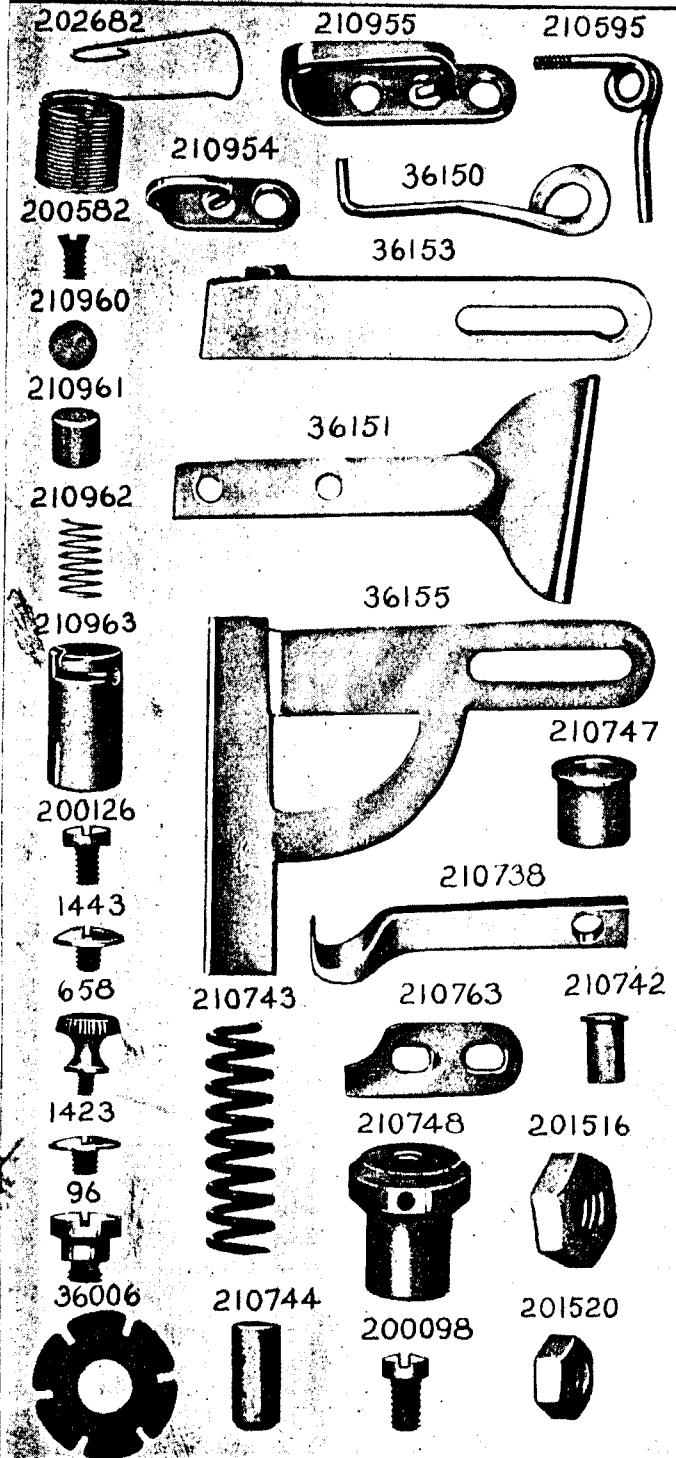

PLATE 14162—ONE-HALF SIZE

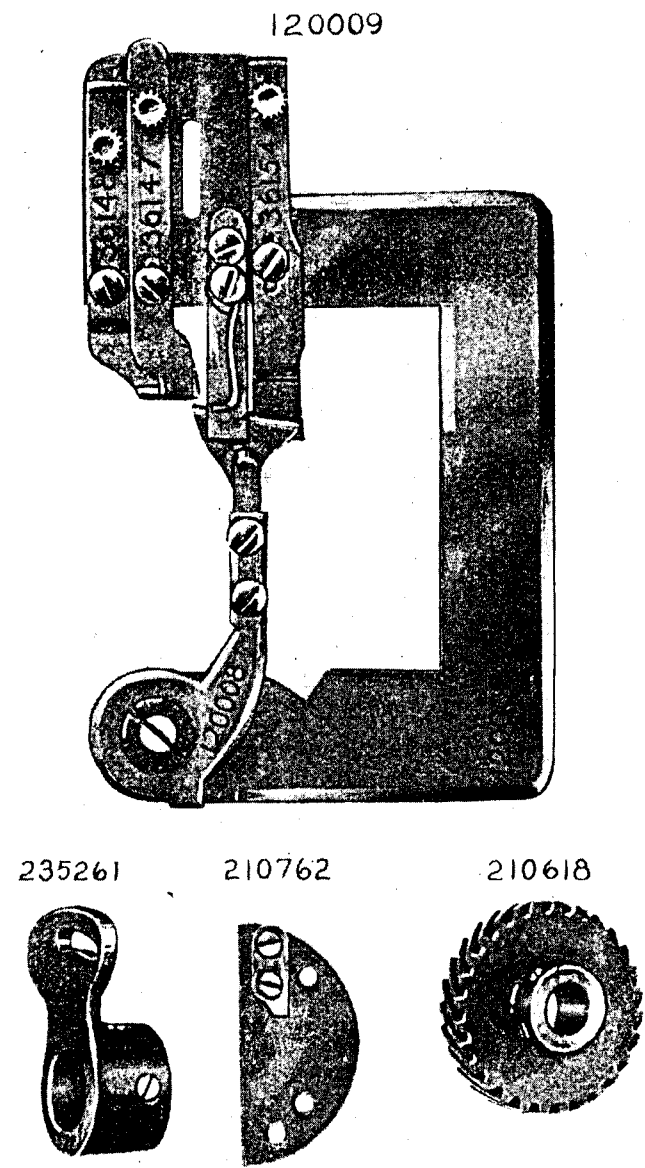

PLATE 14164-FULL SIZE

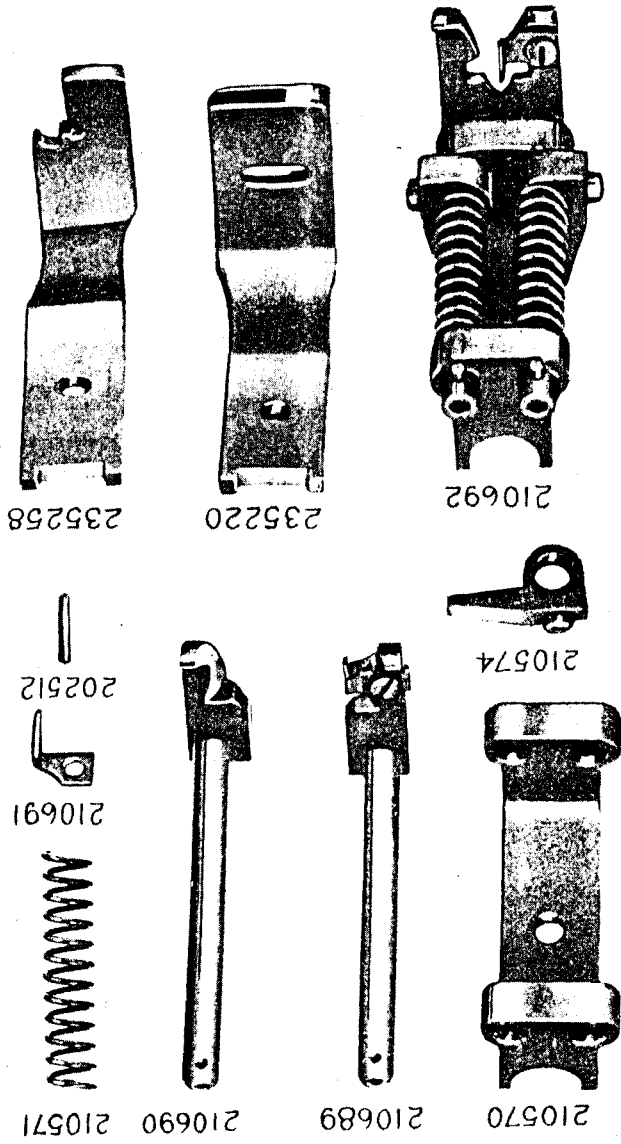

PLATE 14163-FULL SIZE

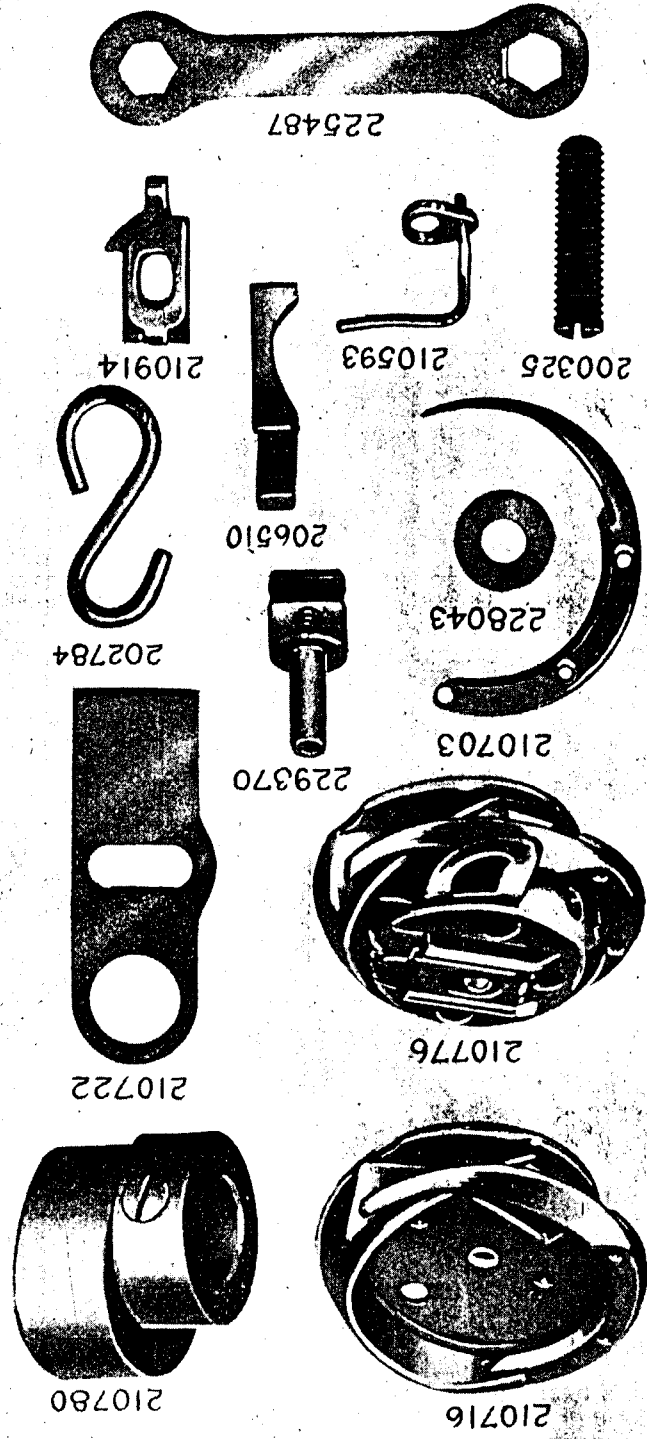

PLATE 14165—FULL SIZE

210680

235254

235259



210518

210517

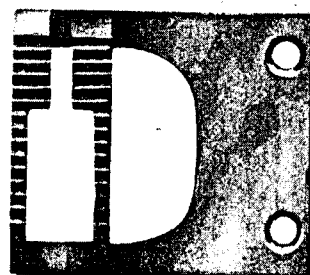
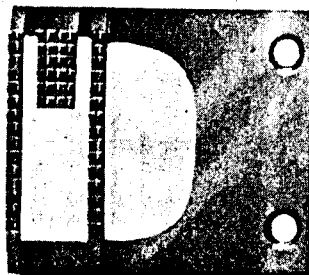

210600

210597

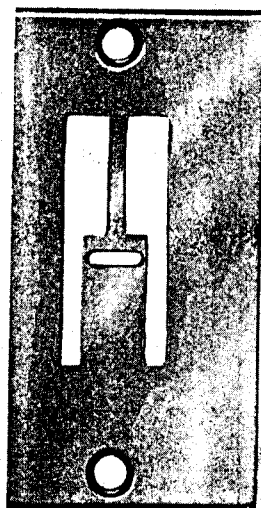
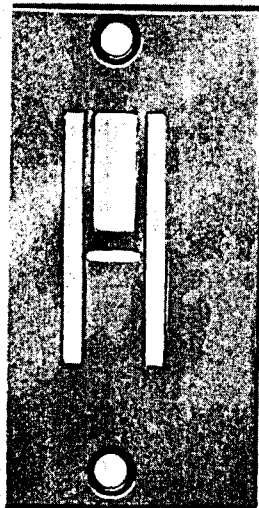
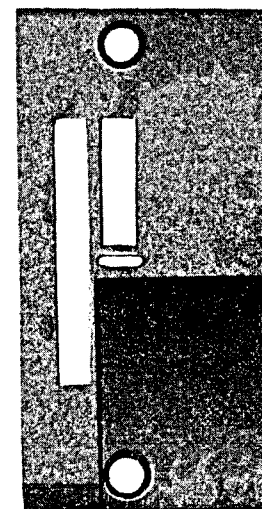
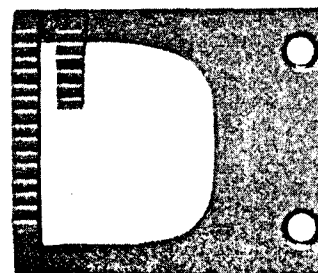

PLATE 14166—FULL SIZE

235253

235260



210524

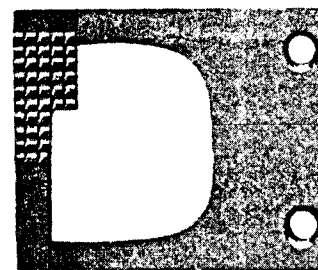

235255

210604

