

Singer 146-1
Singer 146-51

INSTRUCTIONS FOR OILING

Apply "TYPE B" or "TYPE D" OIL, sold only by Singer Sewing Machine Company, to all oil holes, oil tubes and ball oilers often enough to keep the machine well lubricated. The ball oilers prevent dust from clogging the oil tube which retains the wicking for lubricating the rotary shaft crank bearing, and care must be taken to see that the ball oilers return to a closed position after oiling.

"TYPE D" OIL is stainless.

Copyright, U. S. A., 1929, 1933 and 1938
by The Singer Manufacturing Co.
All Rights Reserved for all Countries

INDEX

	Page
Accessories.....	22
Machine No. 146-1.....	5
Machine No. 146-51.....	13
Numerical List of Parts.....	25
Obsolete Parts.....	23
Thread Unwinder.....	22

INSTRUCTIONS FOR ORDERING

5

In ordering from this list, use ONLY the part NUMBER in the FIRST column.

The number stamped on a Sewing Machine Part is in every case the number of the single part only.

Every combination of parts sent out as such has its specific number, which, although not stamped on the parts, must be used when ordering the combination.

Each number always indicates the SAME PART in whatever list it appears, or for whatever machine.

The letters after some of the numbers indicate the style or finish only, as follows:

- A-Hardened, Polished, Nickel Plated and Buffed
- B-Polished, Nickel Plated and Buffed
- C-Hardened Only
- D-Polished Only
- E-Soft, Not Polished
- F-Hardened and Polished
- F.J-Hardened, Polished and Nickel Plated
- G-Bright Rumbled and Nickel Plated
- H-Blued
- J-Nickel Plated Only
- K-Hardened and Nickel Plated
- L-Brass Plated
- M-Oxidized
- N-Japanned, Dull
- P-Japanned, Bright
- R-Merlized
- S-Cadmium Plating
- T-Copper Plated
- T.A-Hardened, Polished, Copper and Nickel Plated and Buffed
- T.B-Copper and Nickel Plated and Polished
- T.J-Copper and Nickel Plated Only
- T.K-Hardened, Copper and Nickel Plated
- T.L-Copper and Brass Plated
- T.M-Copper Plated and Oxidized
- U-Zinc Plated
- V-Silver Plated
- W-Polished and Nickel Plated
- X-Black Oxide, for Iron and Steel
- X.C-Hardened and Black Oxide, for Iron or Steel
- Y-Black Nickel Plated Only
- Z-Chromium Plated
- Z.A-Hardened, Polished, Nickel Plated, Buffed and Chromium Plated
- Z.B-Polished, Nickel Plated, Buffed and Chromium Plated
- Z.C-Hardened and Chromium Plated
- Z.J-Nickel and Chromium Plated

These letters MUST BE USED when they appear in the list; and AFTER the number as in the list.

In this series:

- 1 to 1500, 50001 to 51500 and 140001 to 142000 are Screw Numbers
- 1501 to 1800 and 51501 to 51800 are Nut Numbers
- 1801 to 2000 and 51801 to 52000 are Roller Numbers
- 2001 to 50000 and 52001 to 140000 and 142001 to 190000 are Sewing Machine Parts, 190001 and upward are numbers of Electrical Parts.

The figures in the second column refer only to the plates, illustrating the parts, and are NOT TO BE USED in ordering.

Parts marked with an asterisk (*) are furnished only when repairs are made at factory.

LIST OF PARTS COMPLETE

FOR

MACHINE No. 146-1

(HEAD ONLY)

FOR CLOSING LIGHT AND MEDIUM BAGS AFTER
THEY ARE FILLED. TWO-THREAD CHAIN STITCH.
LIFT OF PRESSER FOOT 5/16 INCH.

No.	Plate	Name
*124170	-----	Arm, upper and lower (solid) with 15404 and two 15405.....
17869	9401	Arm Oil Tube, for intermediate bearing.
17870	9401	" " " for lower bearing.....
15783	-----	" " " for 11119.....
11119	9401	" " " 15783 with 52045 for oiling 49101.....
58030	9401	Arm Oil Tube with 52150 and 54897 for oiling 58033.....
54897	9401	Arm Oil Tube Oil Cup.....
52150	21516	" " " Packing (braided cotton)..
52045	9401	" " " " (wick).....
49156	9405	" Rock Shaft
49004	9401	" " " Bushing (intermediate)..
448C	9431	" " " " " Set Screw.....
49003	9401	Arm Rock Shaft Bushing (upper).....
446C	9431	" " " " " Set Screw
17671	9401	" " " Collar with two 443C....
443C	9401	" " " " " Set Screw.....
49262	9402	" " " Crank (lower) with 50282E and 50457C.....
50282E	9402	Arm Rock Shaft Crank (lower) Position Screw.....
50457C	9402	Arm Rock Shaft Crank (lower) Set Screw.
49261	9402	" " " " (upper) with 50282E and 50457C.....
50282E	9402	Arm Rock Shaft Crank (upper) Position Screw.....

PARTS FOR MACHINE No. 146-1

No.	Plate	Name
50457C	9402	Arm Rock Shaft Crank (upper) Set Screw.
49005	9403	" " " Flanged Bushing (lower).
430C	9431	" " " " " " Set Screw.....
49084	9403	Arm Rock Shaft Oil Cover.....
193J	9430	" " " " " Screw.....
17672	9405	" Rotary Shaft.....
*58059	-----	" " " 17672 with 58033.....
58031	9403	" " " Bushing (lower).....
17674	9403	" " " " " Cap....
435C	9431	" " " " " " Set Screw.....
58032	9403	Arm Rotary Shaft Flanged Bushing (intermediate).....
17675	9403	Arm Rotary Shaft Flanged Bushing (intermediate) Oil Hole Plug.....
42366	9402	Arm Rotary Shaft Flanged Bushing (intermediate) Oil Pad (short) braided cotton.....
446C	9431	Arm Rotary Shaft Flanged Bushing (intermediate) Set Screw.....
49012	9405	Arm Rotary Shaft Flanged Bushing (upper) with 49013 and 49093.....
49093	9406	Arm Rotary Shaft Flanged Bushing (upper) Oil Pad (long) braided cotton.....
49013	9407	Arm Rotary Shaft Flanged Bushing (upper) Oil Pad (short) braided cotton.....
159F	9430	Arm Rotary Shaft Flanged Bushing (upper) Screw.....
449C	9419	Arm Rotary Shaft Lower Bearing Oil Hole Plug Screw.....
144D	9430	Arm Rotary Shaft Screw.....
17676	-----	" Side Cover (left).....
2269	9407	" " " " Stop Pin.....
51224W	21516	" " " " Thumb Screw.....
17677	21518	" " " (right).....
2269	9407	" " " " Stop Pin.....
51224W	21516	" " " " Thumb Screw.....
124001	21517	Balance Wheel and Pulley (tight) 2 7/8 in. diam. with two 430C.....
430C	9431	Balance Wheel Set Screw.....
17679	9407	" " Washer.....
58023	9416	Cloth Plate.....
58024	-----	Cloth Plate complete, Nos. 49054, 58001, 58002, 58023 and two 226J.....
128J	9430	Cloth Plate Screw (lower).....
158F	9430	" " " (upper).....
58033	9405	Crank Connecting Rod with 896E, 49109 and two 145E.....
896E	9430	Crank Connecting Rod Adjusting Screw...

PARTS FOR MACHINE No. 146-1

No.	Plate	Name
49109	9407	Crank Connecting Rod Adjusting Washer..
145E	9430	" " " Cap Screw.....
50244C	9430	" " " Hinge Screw.....
1513J	9431	" " " " " Nut...
49020	21517	Face Plate.....
193F	9430	" " Screw.....
17683	9407	Feed Bar with 220J and 457C.....
17684	9407	" " Hinge Pin.....
457C	9407	" " " Set Screw.....
17685	9405	" Connecting Rod with 2653, 4784, and two 896E.....
896E	9430	Feed Connecting Rod Cap Screw.....
4784	9407	" " " Oil Pad (felt).....
2653	9407	" " " " " Pin.....
17686	9408	" Dog, 14 teeth (10 teeth to the inch) for 58025 and 58028.....
172C	9430	Feed Dog Screw.....
220J	9407	" " Stop Screw.....
17687	9418	" Eccentric with two 1259C.....
1259C	9403	" " Set Screw.....
17688	9418	" Lifting Eccentric with two 1259C..
58054	9424	" " " Connection with 457C, 2653, 4784 and two 1057E.....
1057E	9424	Feed Lifting Eccentric Connection Cap Screw.....
49030	9424	Feed Lifting Eccentric Connection Hinge Pin.....
457C	9407	Feed Lifting Eccentric Connection Hinge Pin Set Screw.....
4784	9407	Feed Lifting Eccentric Connection Oil Pad (felt).....
2653	9407	Feed Lifting Eccentric Connection Oil Pad Pin.....
1259C	9403	Feed Lifting Eccentric Set Screw.....
50245C	9431	" Regulating Screw Stud.....
1731C	9431	" " " " Nut.....
17690	9424	" " " " Sleeve.....
12000	9424	" " " " Stop Pin....
49033	9406	" Rock Shaft.....
124228	-----	Feed Rock Shaft complete, Nos. 49033 and 124227.....
124227	9406	Feed Rock Shaft Crank with 12000 and two 1177E.....
1177E	9422	Feed Rock Shaft Crank Clamping Screw...
17693	9406	" " " Hinge Pin.....
1508E	9431	" " " " " Nut.....
622C	9431	" " " " " Screw Bearing
1508E	9431	" " " " " " Nut
27398	9424	" " " Washer.....

No.	Plate	Name
49036	9413	Looper with 590D and 49080.....
17694	9410	" Bell Crank.....
49039	9413	" " " Hinge Stud.....
448C	9431	" " " " " Set Screw.
17695	9410	" " " Pitman with two each 175E and 1057E.....
50070C	9414	Looper Bell Crank Pitman Ball Screw Stud (back).....
1636C	9431	Looper Bell Crank Pitman Ball Screw Stud (back) Nut.....
50246C	9431	Looper Bell Crank Pitman Ball Screw Stud (front).....
1619E	9431	Looper Bell Crank Pitman Ball Screw Stud (front) Nut.....
175E	9430	Looper Bell Crank Pitman Cap (back) Screw.....
1057E	9424	Looper Bell Crank Pitman Cap (front) Screw.....
49044	9413	Looper Carrier with 4784 and two each 175E, 1147C and 59019.....
175E	9430	Looper Carrier Clamping Screw.....
59019	9413	" " Gib.....
38440	9413	" " Hinge Pin.....
157E	9430	" " " Clamping Screw
4784	9407	" " Oil Pad (felt).....
124174	9414	Looper Carrier Pitman complete, Nos. 1708E, 1709E, 49046, 49088 and 124177.
50070C	9414	Looper Carrier Pitman Ball Screw Stud (upper).....
1519E	9431	Looper Carrier Pitman Ball Screw Stud (upper) Nut.....
46237	9414	Looper Carrier Pitman Ball Stud (lower)
1147C	9413	" " " " " " Set Screw.....
171E	9430	Looper Carrier Pitman Cap (lower) Screw
175E	9430	" " " " " (upper) Screw
*49086	-----	" " " End Bearing (low- er).....
*124176	-----	Looper Carrier Pitman End Bearing (up- per).....
49086	9414	Looper Carrier Pitman Head (lower) Nos. 46237, 49086 and two 171E.....
124177	9414	Looper Carrier Pitman Head (upper) Nos. 50070C, 124176 and two 175E.....
49046	9414	Looper Carrier Pitman Rod.....
1708E	9431	" " " " Nut (lower)..
1709E	9431	" " " " " (upper)..
49043	9424	" " " " Washer (fibre)
137136	21518	" " Rock Shaft.....

No.	Plate	Name
11411	9414	Looper Carrier Rock Shaft Collar with 453C.....
453C	9414	Looper Carrier Rock Shaft Collar Set Screw.....
124173	9414	Looper Carrier Rock Shaft Crank (lower) with 156C, 157E and 443C.....
156C	9414	Looper Carrier Rock Shaft Crank (lower) Position Screw.....
443C	9401	Looper Carrier Rock Shaft Crank (lower) Set Screw.....
49276	21518	Looper Carrier Rock Shaft Crank (upper) forked with 140174C.....
140174C	21516	Looper Carrier Rock Shaft Crank (upper) Position Screw.....
49049	9414	Looper Carrier Rock Shaft Crank (upper) Slide Block.....
49051	9412	Looper Eccentric with two 1259C.....
122091	-----	" " 49051 with 49049.....
1259C	9403	" " Set Screw.....
58001	9411	" Gate with 735C.....
58002	9412	" " Hinge Pin.....
735C	9425	" " " " Set Screw.....
49084	9412	" " Lock Spring.....
226J	9430	" " " " Screw.....
1147C	9413	" Set Screw.....
49080	9413	" Thread Guard.....
590D	9413	" " " Screw.....
58052	9415	Needle Bar.....
49056	9415	" " Bushing (back).....
435C	9431	" " " " Set Screw....
58035	9415	" " " (front).....
1133E	9431	" " " " Set Screw....
*49101	9415	" " Connecting Link.....
49167	-----	" " " " 49101 with 49057 and 49268.....
49057	9415	Needle Bar Connecting Link Hinge Stud..
1517J	9431	" " " " " Nut
49268	9415	" " " Stud with 1454E..
1454E	9415	" " " "Clamping Screw
1629C	9415	" Clamping Nut.....
58036	9411	Oil Pipe.....
58037	-----	" " 58036 with 54897, 58038 and 58039 for Arm Rotary Shaft Lower Bearing.....
58038	9417	Oil Pipe Holder.....
54897	9401	" " " Oil Cup.....
58039	9417	" " Packing (braided cotton).....
449C	9419	" " Set Screw.....
58040	9417	" Tube for 58041.....

No.	Plate	Name
58041	-----	Oil Tube 58040 with 58044 and 58045 for oiling 49049 and 49051.....
58042	9417	Oil Tube for 58043.....
58043	-----	" " 58042 with 58044 and 58045 for Arm Rotary Shaft Intermediate Bearing.....
58044	9417	Oil Tube Connection with two 198J.....
196J	9417	" " " Cap Screw.....
58045	21516	" " Packing (braided cotton).....
49059	9411	Presser Bar.....
49060	9417	" " Bushing (back).....
435C	9431	" " " " Set Screw...
49061	9417	" " " (front).....
1133E	9431	" " " " Set Screw...
58046	9428	" " Lifter.....
49065	9417	" " " Bracket with 453C and 892F.....
892F	9417	Presser Bar Lifter Bracket Adjusting Screw.....
453C	9414	Presser Bar Lifter Bracket Set Screw...
212D	9430	" " " Cap Screw.....
58047	9428	" " " Hinge Stud.....
453C	9414	" " " " Set Screw
58048	9428	" " " Link.....
212D	9430	" " " Cap Screw.....
1253C	9417	" " " Hinge Screw Stud
58049	9428	" " " Spring.....
1241E	9428	" " " " Screw Stud
49067	9427	" " Spring (flat).....
38468	9428	" " Stud.....
137088	21516	" Foot Finger Guard.....
227J	21516	" " " Screw.....
58004	-----	" " Plate.....
50087J	9408	" " Hinge Screw.....
58005	-----	" Shank.....
137089	-----	" Toe with 227J, 906C and 137088.....
58007	9408	Presser Foot Toe Hinge Stud.....
906C	9408	" " " " Set Screw..
58008	9408	" " Spring.....
137090	21516	Presser Foot (hinged) complete, Nos. 50087J, 58004, 58005, 58007, 58008 and 137089.....
190J	9430	Presser Foot Screw.....
574W	9431	Pressure Regulating Thumb Screw.....
1539W	9431	" " " Lock Nut
137131	21517	Pulley (loose) 2 7/8 in. diam. with 200584D.....
137132	-----	Pulley (loose) 137131 with 68714.....

No.	Plate	Name
137136	-----	Pulley (loose) 137132 with 137133.....
68714	21518	" " Ball Bearing.....
200584D	21516	" " Oil Plug Screw.....
137133	21516	" " Spacing Collar.....
137130	-----	Pulleys (ball bearing) complete, Nos. 124001 and 137136.....
2102	9419	Tension (looper thread) Disc.....
1560C	9419	" " " Regulating Thumb Nut.....
916C	9419	Tension (looper thread) Screw Stud.....
44209	-----	" " " " " 916C with 1560C.....
10148	9419	Tension (looper thread) Spring.....
17547	9419	" " " Thread Guide...
2102	9419	" (needle thread) Disc.....
1560C	9419	" " " Regulating Thumb Nut.....
916C	9419	Tension (needle thread) Screw Stud.....
44209	-----	" " " " " 916C with 1560C.....
13710	9419	Tension (needle thread) Spring.....
17547	9419	" " " Thread Guide...
58010	9428	Thread Cutting Blade (inside) with 1933
58011	9428	" " " (outside) with 1933
50247C	9431	" " Hinge Screw.....
1732H	9420	" " " " " Nut....
1933	9428	" " Roller and Stud....
17622	9421	" " Spring.....
124256	-----	" " Lever.....
58012	9426	" " " 124256 with 58013 and two 161D.....
58013	9420	Thread Cutting Lever Extension.....
161J	9430	" " " Screw...
124171	9421	" " Hinge Stud.....
448C	9431	" " " " Set Screw
58014	9421	" " Plate.....
172C	9430	" " " Screw.....
8885	21516	" " Spring.....
170D	9421	" " " Screw Stud.
49071	9420	" (looper) Eyelet.....
172C	9430	" " " Screw.....
49072	9423	" " Take-up.....
190J	9430	" " " Screw.....
49073	9422	" (needle) Controller.....
974F	9420	" " Hinge Screw.
914F	9430	" " " Screw.....
39541	9425	" " " Washer
49075	9425	" " Take-up with 457C.....
457C	9407	" " " Set Screw.....

No.	Plate	Name
58025	9408	Throat Plate (large needle hole) for 17686.....
58028	9408	Throat Plate (small needle hole) for 17686.....
691F	9431	Throat Plate Screw (large).....
402D	9431	" " " (small).....
*15404	-----	Trade Mark.....
15405	-----	" " Rivet.....

SINGER Needles should be used
in SINGER Machines.
These Needles and their Containers
are marked with the
Company's Trade Mark "SIMANCO.***" 1

Needles in Containers marked
"FOR SINGER MACHINES"
are NOT **SINGER** made needles. 2

LIST OF PARTS COMPLETE
FOR
MACHINE No. 146-51

(HEAD ONLY)

FOR CLOSING HEAVY BAGS AFTER THEY ARE
FILLED. TWO INDEPENDENT PRESSER BARS
AND HINGED PRESSER FEET. LIFT OF PRESSER
FEET 5/8 INCH.

No.	Plate	Name
*124178	-----	Arm, upper and lower (solid) with 15404 and two 15405.....
58030	9401	Arm Oil Tube with 52150 and 54897 for oiling 122012 (lower bearing).....
124179	9401	Arm Oil Tube with 52045 for oiling in- termediate bearing.....
17870	9401	Arm Oil Tube for oiling 49101.....
54897	9401	" " " Oil Cup for 58030.....
52150	21516	" " " Packing (braided cotton)..
52045	9401	" " " " (wick).....
122097	9416	" Rock Shaft.....
49003	9401	" " " Bushing (back).....
446C	9431	" " " " Set Screw
122003	9401	" " " " (front).....
446C	9431	" " " " Set Screw
49004	9401	" " " " (intermediate)
446C	9431	" " " " Set
		Screw.....
49006	9401	Arm Rock Shaft Collar with two 443C....
443C	9401	" " " " Set Screw.....
122098	9402	" " " Crank (back) with 50582C and two 51157C.....
50582C	9402	Arm Rock Shaft Crank (back) Position Screw.....
51157C	21516	Arm Rock Shaft Crank (back) Set Screw..
122099	9402	" " " " (front) with 50582C and 51157C.....

No.	Plate	Name
50582C	9402	Arm Rock Shaft Crank (front) Position Screw.....
51157C	21516	Arm Rock Shaft Crank (front) Set Screw.
49005	9403	" " " Flanged Bushing (front).
446C	9431	" " " " " " Set Screw.....
49084	9403	Arm Rock Shaft Oil Cover.....
152J	9430	" " " " " Screw.....
124180	9416	" Rotary Shaft.....
124230	-----	" " " 124180 with 124229....
124181	9403	" " " Bushing (front).....
435C	9431	" " " " " Set Screw
124182	9403	" " " " (intermediate)
446C	9431	" " " " " Set Screw.....
49010	9403	Arm Rotary Shaft Collar with two 1259C.
1259C	9403	" " " " Set Screw.....
49012	9405	" " " Flanged Bushing (back) with 49013 and 49093.....
49093	9406	Arm Rotary Shaft Flanged Bushing (back) Oil Pad (long) braided cotton.....
49013	9407	Arm Rotary Shaft Flanged Bushing (back) Oil Pad (short) braided cotton.....
159F	9430	Arm Rotary Shaft Flanged Bushing (back) Screw.....
64805	9417	Arm Rotary Shaft Flanged Bushing Oil Pad (braided cotton) for intermediate bearing.....
49014	9403	Arm Rotary Shaft Flanged Bushing (intermediate).....
448C	9431	Arm Rotary Shaft Flanged Bushing (intermediate) Set Screw.....
144D	9430	Arm Rotary Shaft Screw.....
17676	-----	" Side Cover (left).....
2269	9407	" " " " Stop Pin.....
51224W	21516	" " " " Thumb Screw.....
17677	21518	" " " (right).....
2269	9407	" " " " Stop Pin.....
51224W	21516	" " " " Thumb Screw.....
124183	9416	Balance Wheel and Pulley (tight) 4 3/8 in. diam. with two 430C.....
430C	9431	Balance Wheel Set Screw.....
17679	9407	" " " Washer.....
124184	9416	Cloth Plate.....
124185	-----	Cloth Plate complete, Nos. 420C5, 52716, 124184, 124191 and two 217J.....
50467F	9431	Cloth Plate Screw (top of plate).....
1489D	9430	" " " (side of plate).....
122012	9405	Crank Connecting Rod with 896E, 49109 and two 145E.....

No.	Plate	Name
124229	-----	Crank Connecting Rod 122012 with 1513J and 50244C.....
896E	9430	Crank Connecting Rod Adjusting Screw...
49109	9407	" " " " Washer..
145E	9430	" " " Cap Screw.....
50244C	9430	" " " Hinge Screw.....
1513J	9431	" " " " " Nut...
122013	21517	Face Plate.....
193F	9430	" " Screw.....
122014	9406	Feed Bar.....
122015	-----	Feed Bar complete, Nos. 190J, 457C, 1258C, 122014, 122016 to 122018 and two 704C.....
124231	-----	Feed Bar 122015 with 122024 and 124186.
122016	9418	" " Extension.....
704C	9430	" " " Screw.....
124186	9418	" " Hinge Pin.....
1258C	9431	" " " " Set Screw.....
122017	9418	" " Oil Pad (braided cotton).....
122018	9418	" " Wearing Plate.....
190J	9430	" " " Screw.....
124187	9409	" Dog, 16 teeth (5 1/3 teeth to the inch) for 124217.....
157E	9430	Feed Dog Screw.....
457C	9407	" " Stop Screw.....
124188	9424	" Eccentric with two 1036C.....
122101	21518	" " Connection with 896E, 2653, 4784, 49109 and two 145E....
896E	9430	Feed Eccentric Connection Adjusting Screw.....
49109	9407	Feed Eccentric Connection Adjusting Screw Washer.....
145E	9430	Feed Eccentric Connection Cap Screw....
4784	9407	" " " Oil Pad (felt)
2653	9407	" " " " Pin...
1036C	9424	" " Set Screw.....
122023	9424	" Lifting Cam with 1258C.....
1258C	9431	" " " Set Screw.....
50086C	9430	" Regulating Screw Stud.....
1714C	9431	" " " " Nut.....
49031	9424	" " " " Sleeve.....
49032	9424	" " " " Washer.....
122024	9406	" Rock Shaft with two 1258C.....
122025	9406	" " " Hinge Pin.....
124189	9424	" " " " Bushing.....
448C	9431	" " " " " " Set Screw.....
1258C	9431	Feed Rock Shaft Set Screw.....
122028	9413	Looper (double thread).....

No.	Plate	Name
122029	9413	Looper (single thread).....
122030	9410	" Bell Crank.....
122095	-----	" " " 122030 with 49039....
49039	9413	" " " Hinge Stud.....
448C	9431	" " " " Set Screw.
4784	9407	" " " Oil Pad (felt).....
122031	9410	" " " Pitman with two each 171E and 1057E.....
50070C	9414	Looper Bell Crank Pitman Ball Screw Stud (lower).....
1519C	9431	Looper Bell Crank Pitman Ball Screw Stud (lower) Nut.....
50069C	9431	Looper Bell Crank Pitman Ball Screw Stud (upper).....
1619E	9431	Looper Bell Crank Pitman Ball Screw Stud (upper) Nut.....
171E	9430	Looper Bell Crank Pitman Cap (lower) Screw.....
1057E	9424	Looper Bell Crank Pitman Cap (upper) Screw.....
49043	9424	Looper Bell Crank Pitman Washer (fibre)
122032	9413	" Carrier with two each 175E, 59019, and three 1120C.....
122090	-----	Looper Carrier 122032 with 122040 and 124193.....
175E	9430	Looper Carrier Adjusting Screw.....
124193	9417	" " Collar with two 1253C...
1253C	9417	" " " Set Screw.....
59019	9413	" " Gib.....
4784	9407	" " Oil Pad (felt).....
122033	9410	Looper Carrier Pitman complete, Nos. 1722E, 1723E and 122036 to 122038..
50070C	9414	Looper Carrier Pitman Ball Screw Stud (right).....
1519E	9431	Looper Carrier Pitman Ball Screw Stud (right) Nut.....
46237	9414	Looper Carrier Pitman Ball Stud (left)
1120C	9413	" " " " " Set Screw.....
171E	9430	Looper Carrier Pitman Cap (left) Screw.
171E	9430	" " " " (right) Screw.
*122034	-----	" " " End Bearing(left)
*122035	-----	" " " " (right)
122036	9410	" " " Head (left) Nos. 46237, 122034 and two 171E.....
122037	9410	Looper Carrier Pitman Head (right) Nos. 50070C, 122035 and two 171E.....
122038	9410	Looper Carrier Pitman Rod.....
1722E	9431	" " " " Nut (left)...

No.	Plate	Name
1723E	9431	Looper Carrier Pitman Rod Nut (right)..
49043	9424	" " " " Washer (fibre)
137139	21517	" " Rock Shaft.....
11411	9414	" " " " Collar with 453C.....
453C	9414	Looper Carrier Rock Shaft Collar Set Screw.....
49276	21518	Looper Carrier Rock Shaft Crank (back) forked with 140174C.....
140174C	21516	Looper Carrier Rock Shaft Crank (back) Position Screw.....
49049	9414	Looper Carrier Rock Shaft Crank (back) Slide Block.....
122040	9412	Looper Carrier Rock Shaft Crank (front) with two 1255D.....
1255D	9412	Looper Carrier Rock Shaft Crank (front) Clamping Screw.....
49051	9412	Looper Eccentric with two 1259C.....
122091	-----	" " 49051 with 49049.....
1259C	9403	" " Set Screw.....
124191	9416	" Gate with 1259C.....
52716	9412	" " Hinge Pin.....
1259C	9403	" " " " Set Screw.....
42005	9412	" " Lock Spring.....
217J	9430	" " " " Screw.....
1120C	9413	" Set Screw.....
122042	9411	Needle Bar (hollow).....
122043	9415	" " Bushing (lower).....
452C	9431	" " " " Set Screw...
124192	9415	" " " (upper).....
452C	9431	" " " " Set Screw...
*49101	9415	" " Connecting Link.....
122100	-----	" " " " 49101 with 1517J, 49057, 122045 and 122099....
49057	9415	Needle Bar Connecting Link Hinge Stud..
1517J	9431	" " " " " Nut
122045	9415	" " " Stud with two 1454E
1454E	9415	" " " Clamping Screw
2102	9419	" " Thread Retainer Disc.....
1560C	9419	" " " " Regulating Thumb Nut.....
916C	9419	Needle Bar Thread Retainer Screw Stud..
44209	-----	" " " " " 916C, with 1560C.....
10148	9419	Needle Bar Thread Retainer Spring.....
1753C	9415	" Clamping Nut.....
122047	9415	" Guard.....
190J	9430	" " Screw.....
122048	9411	Presser Bar (left).....

PARTS FOR MACHINE No. 146-51

No.	Plate	Name
59033	9417	Presser Bar (left) Bushing (lower).....
452C	9431	" " " " " " Set
		Screw.....
122049	9417	Presser Bar (left) Bushing (upper).....
452C	9431	" " " " " " Set
		Screw.....
124193	9417	Presser Bar (left) Collar with two
		1253C.....
1253C	9417	Presser Bar (left) Collar Set Screw....
122050	9417	" " " " Lifting Bracket with
		1258C.....
1258C	9431	Presser Bar (left) Lifting Bracket Set
		Screw.....
124194	9426	Presser Bar Lifter.....
15486	9428	" " " " Hinge Stud.....
452C	9431	" " " " " " Set Screw
439C	9426	" " " " Stop Screw.....
124195	9411	" " " " Lifting Lever.....
89C	9431	" " " " " " Hinge Screw..
122051	9411	" " " " (right).....
59033	9417	" " " " Bushing (lower)....
452C	9431	" " " " " " Set
		Screw.....
122049	9417	Presser Bar (right) Bushing (upper)....
452C	9431	" " " " " " Set
		Screw.....
122052	9417	Presser Bar (right) Lifting Bracket
		with 1258C.....
1258C	9431	Presser Bar (right) Lifting Bracket Set
		Screw.....
122054	9427	Presser Bar Spring (flat).....
122055	9427	" " " " Bracket.....
1396R	9430	" " " " " " Screw.....
38468	9428	" " " " Stud.....
124196	-----	" " " " Foot (left) Plate.....
646F	9429	" " " " " " Hinge Screw..
122057	-----	" " " " Shank.....
124197	9429	Presser Foot (left hinged) complete,
		Nos. 646F, 122C57, 124196, 124198 and
		two 233J.....
124198	9429	Presser Foot (left) Finger Guard.....
233J	9429	" " " " " " Screw.
898J	9430	" " " " " " Screw.....
124199	9429	" " " " (right).....
898J	9430	" " " " " " Screw.....
574W	9431	Pressure Regulating Thumb Screw.....
1539W	9431	" " " " " " Lock Nut
124200	9427	Pulley (loose) 4 3/8 in. diam.....
122062	9419	Tension (looper thread) Disc.....

PARTS FOR MACHINE No. 146-51

No.	Plate	Name
1560C	9419	Tension (looper thread) Regulating
		Thumb Nut.....
50261C	9419	Tension (looper thread) Screw Stud.....
64881	-----	" " " " " " 50261C
		with 1560C.....
122063	9419	Tension (looper thread) Screw Stud
		Sleeve.....
52975	9419	Tension (looper thread) Spring.....
13915	9419	" " " " " " Bushing.
122062	9419	" " (needle thread) Disc.....
1560C	9419	" " " " Regulating Thumb
		Nut.....
50261C	9419	Tension (needle thread) Screw Stud.....
64881	-----	" " " " " " 50261C
		with 1560C.....
122063	9419	Tension (needle thread) Screw Stud
		Sleeve.....
52975	9419	Tension (needle thread) Spring.....
13915	9419	" " " " " " Bushing.
124201	9419	Thread Cutting Blade (left) with 1933..
1933	9428	" " " " " " Roller and
		Stud.....
124202	9419	Thread Cutting Blade (right) with 51862
51862	9419	" " " " " " Roller and
		Stud.....
124203	9419	Thread Cutting Blade Connecting Link...
741R	9431	" " " " " " Hinge
		Screw.....
124204	9421	Thread Cutting Blade Guide Plate.....
6COR	9430	" " " " " " Screw.
124205	9421	" " " " " " Hinge Stud.....
199R	9430	" " " " " " Cap Screw
124206	9421	" " " " " " Spring.....
964R	9430	" " " " " " Screw.....
124207	9426	" " " " " " Lever.....
14223	9420	" " " " " " Handle with 1518E.
1518E	9420	" " " " " " Nut.....
802D	9430	" " " " " " Hinge Screw.....
124208	9420	" " " " " " Spring.....
124209	9420	" " " " " " Stop.....
160D	9430	" " " " " " Screw.....
1204E	9420	" " " " " " Stud...
9525	9420	" " " " " " Washer.
122064	9420	" " " " " " Eyelet (side of arm).....
452C	9431	" " " " " " Set Screw..
124210	9423	" " " " " " Guard (back of arm).....
122065	9420	" " " " " " Guide (side of arm).....
452C	9431	" " " " " " Screw.....
122066	9422	" " " " " " (under) Take-up.....

PARTS FOR MACHINE No. 146-51

No.	Plate	Name
122020	9422	Thread (under) Take-up Eccentric with 1036C.....
1036C	9424	Thread (under) Take-up Eccentric Set Screw.....
122067	9422	Thread (under) Take-up Lever with two each 145E and 1279F.....
145E	9430	Thread (under) Take-up Lever Cap Screw.
122069	9425	" " " " Connection
11411	9414	" " " " " "
		Collar with 453C.....
453C	9414	Thread (under) Take-up Lever Connection Collar Set Screw.....
375C	9431	Thread (under) Take-up Lever Hinge Screw.....
1519E	9431	Thread (under) Take-up Lever Hinge Screw Nut.....
1279F	9430	Thread (under) Take-up Set Screw.....
122070	9421	" " " Stripper.....
122071	9422	" " " Bracket with three 462C.....
122072	9421	Thread (under) Take-up Stripper Bracket Bushing.....
462C	9431	Thread (under) Take-up Stripper Bracket Bushing Set Screw.....
690D	9430	Thread (under) Take-up Stripper Bracket Screw.....
462C	9431	Thread (under) Take-up Stripper Set Screw.....
124211	9423	Thread (upper) Controller with 1320C and 124215.....
124212	9423	Thread (upper) Controller Connecting Link.....
974F	9420	Thread (upper) Controller Connecting Link Hinge Screw.....
1131F	9431	Thread (upper) Controller Hinge Screw..
124213	9423	" " " Lever.....
63C	9430	" " " Hinge Screw.....
124214	9425	Thread (upper) Controller Lever Lifting Bracket with 1036C and 1823.....
1823	9425	Thread (upper) Controller Lever Lifting Bracket Roller and Stud.....
1036C	9424	Thread (upper) Controller Lever Lifting Bracket Set Screw.....
124215	9425	Thread (upper) Controller Roller.....
1320C	9431	" " " " Screw.
46383	9425	" " Nipper Cam with two 1253C
1253C	9417	" " " Set Screw.....
32191	9425	" " " Disc.....

PARTS FOR MACHINE No. 146-51

No.	Plate	Name
1535C	9420	Thread (upper) Nipper Regulating Thumb Nut.....
122074	9425	Thread (upper) Nipper Releaser.....
122075	9407	" " " Releasing Pin....
735C	9425	" " " " " Set Screw.....
1979	9425	Thread (upper) Nipper Roller and Stud.....
122076	9421	Thread (upper) Nipper Roller Bracket with 735C.....
122096	-----	Thread (upper) Nipper Roller Bracket 122076 with 1979 and 122075.....
122077	9425	Thread (upper) Nipper Spring.....
122078	9425	" " " Stud.....
1036C	9424	" " " " Set Screw...
124216	9425	" " Take-up with 49223 and 49224.....
49223	9425	Thread (upper) Take-up Roller.....
49224	9425	" " " " Pin.....
45083	9425	" " " Washer.....
124217	9409	Throat Plate for 124187.....
742F	9431	" " Screw.....
*15404	-----	Trade Mark.....
15405	-----	" " Rivet.....

SINGER Needles should be used
in SINGER Machines.
These Needles and their Containers
are marked with the
Company's Trade Mark "SIMANCO.**" 1

Needles in Containers marked
"FOR SINGER MACHINES"
are NOT **SINGER** made needles. 2

ACCESSORIES

No.	Plate	Name
120908	21517	Bag Guide Hook.....
120344	9432	Oiler (copper plated) with 120345.....
120345	9432	" Spout, 4 1/2 in. long.....
11831	9432	Screw Driver (large).....
26026	9432	" " (medium).....
26485	9432	" " (small).....
120341	9432	Tweezers (curved).....
9908	21518	Wrench for 1519.....
8909	21518	" " 1513, 1518 and 1636.....
25200	21518	" " 1731.....
27662	21518	" " 1508 and 1619.....
42089	9433	" " 1629.....

THREAD UNWINDER

FOR TWO SPOOLS OR TWO LARGE CONES OF THREAD

No.	Plate	Name
225257	20335	Spool Rest with 201018C.....
150203	20335	" " Cushion (felt).....
225388	20335	" " Rod.....
200383C	21516	" " " Set Screw.....
201018C	21516	" " Set Screw.....
202490	20335	" Stand with 200383C.....
225391	20335	Thread Guide.....
201696J	21516	" " Lock Nut.....
225326	20335	" " Position Cup.....
225324	20335	" " Rod with 208E and 225322..
208E	21516	" " " Screw.....
225322	21516	" " " Washer.....
225258	20335	Thread Unwinder complete, Nos. 201696J, 202490, 225257, 225324, 225326, 225388, two each 150203, 225391 and three wood screws 7/8 in. No. 12.....
27739	21517	Thread Cone (wood) for large cones....
225390	21517	" " Holder for inverted cones..

Note: Nos. 27739 and 225390 are used with but not included in 225258.

OBSOLETE PARTS

No.	Plate	Name
29599	9401	Arm Oil Tube Packing (felt) for 146-1 Machine, use 52150.....
50282C	9402	Arm Rock Shaft Crank (back) Set Screw for 146-51 Machine, use 51157C.....
50282C	9402	Arm Rock Shaft Crank (front) Set Screw for 146-51 Machine, use 51157C.....
448C	9431	Arm Rotary Shaft Bushing (front) Set Screw for 146-51 Machine, use 435C.
286D	9431	Arm Side Cover (left) Thumb Screw, use 51224W.....
286D	9431	Arm Side Cover (right) Thumb Screw, use 51224W.....
122021	9406	Feed Eccentric Connection with 2653, 4784 and two 145E for 146-51 Ma- chine, use 122101.....
21506	9413	Looper Carrier Collar with 457C for 146-51 Machine, use 124193.....
457C	9407	Looper Carrier Collar Set Screw for 21506.....
124172	9412	Looper Carrier Rock Shaft for 146-1 Ma- chine, obsolete superseded by 137138, not interchangeable.....
124190	9410	Looper Carrier Rock Shaft for 146-51 Machine, obsolete superseded by 137139, not interchangeable.....
49048	9414	Looper Carrier Rock Shaft Crank (back) forked with 50083C, for 146-51 Ma- chine, obsolete superseded by 49276, not interchangeable.....
49048	9414	Looper Carrier Rock Shaft Crank (upper) forked with 50083C, for 146-1 Ma- chine, obsolete superseded by 49276, not interchangeable.....
50083C	9414	Looper Carrier Rock Shaft Crank (back) Set Screw for 49048.....
50083C	9414	Looper Carrier Rock Shaft Crank (upper) Set Screw for 49048.....
58003	9408	Presser Foot Guard for 58006, obsolete superseded by 137088, not inter- changeable.....
58009	9408	Presser Foot (hinged) complete, for 146-1 Machine, Nos. 50087D and 58004 to 58008, use 137090.....

OBSOLETE PARTS

No.	Plate	Name
58006	-----	Presser Foot Toe with 906C and 58003, for 58009, obsolete superseded by 137089, not interchangeable.....
124002	9427	Pulley (loose) 2 7/8 in. diam. for 146-1 Machine, use 137136.....
19510	9421	Thread Cutting Lever Spring for 146-1 Machine.....
124161	9433	Wrench for 1513.....
124162	9433	" " 1518, 1519, 1619 and 1731....
124163	9433	" " 1508.....
124165	9433	" " 1636.....

SINGER Needles should be used
in SINGER Machines.
These Needles and their Containers
are marked with the
Company's Trade Mark "SIMANCO.***" 1

Needles in Containers marked
"FOR SINGER MACHINES"
are NOT **SINGER** made needles. 2

PLATE 9401—FULL SIZE

58030



17670



17669



124179



11119



54897



52045



29599



443



122003



49003



49004

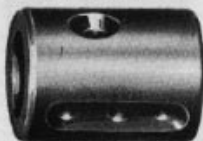

49006



17671

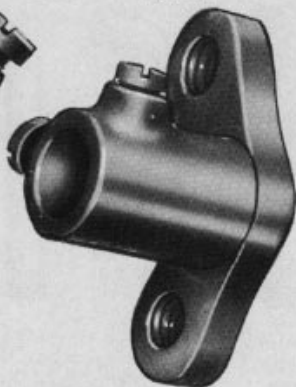

PLATE 9402—FULL SIZE

49262



49261



42366



50282



50582



50457



122099

122098

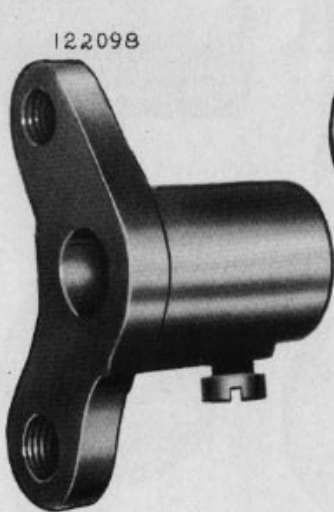
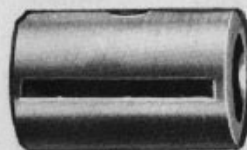

PLATE 9403—FULL SIZE

124182



58031



49005



49014



58032



124181

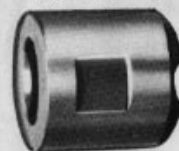

49010



49084



17675



17674



1259



PLATE 9405—ONE-HALF SIZE

17672



49156



122012



58033



17685



49012

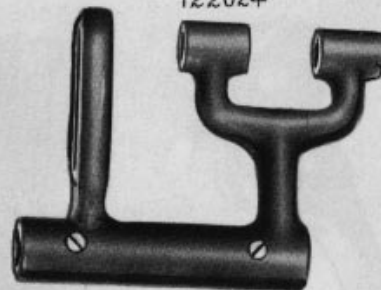

PLATE 9406—ONE-HALF SIZE

17693



122024



122025



122021



124227



49093



49033



122014

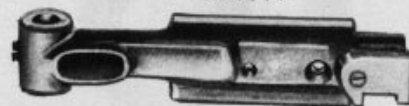

PLATE 9407—FULL SIZE

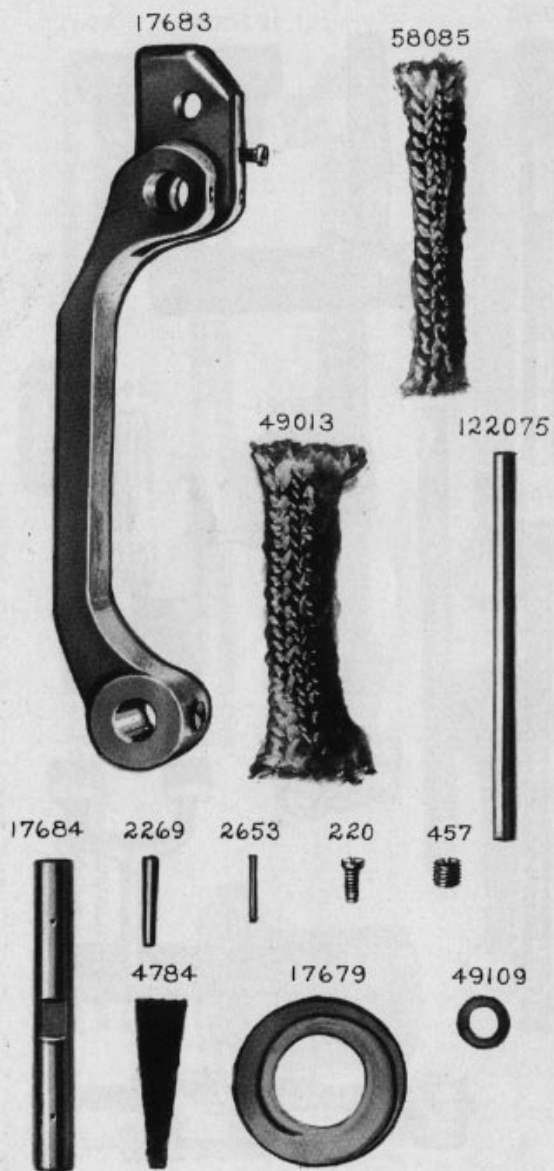

PLATE 9408—FULL SIZE

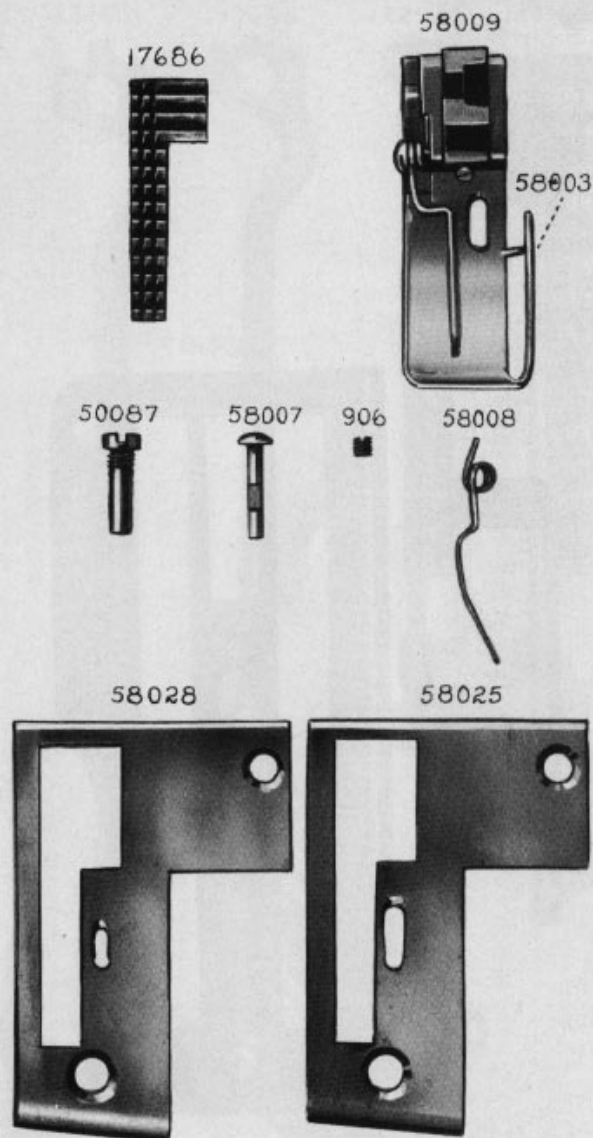
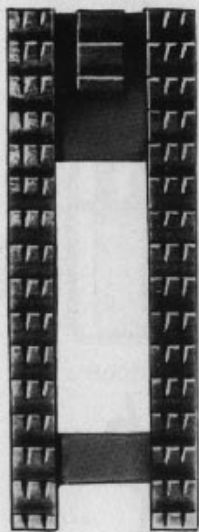

PLATE 9409—FULL SIZE

124187



124217

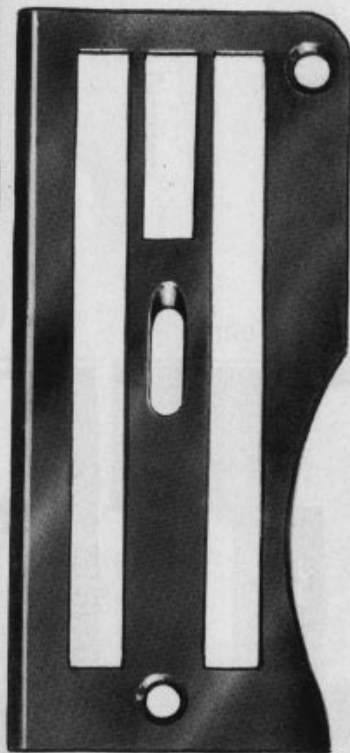
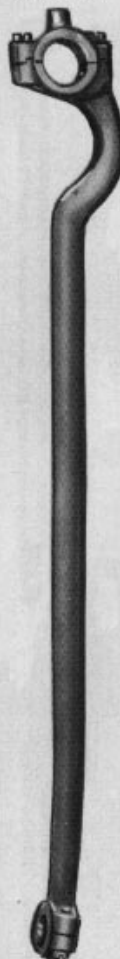
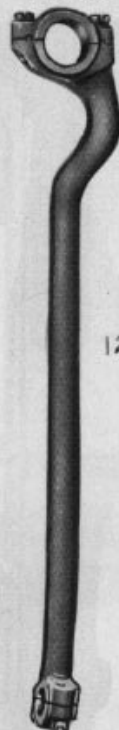

PLATE 9410—ONE-HALF SIZE

122031



17695



122033

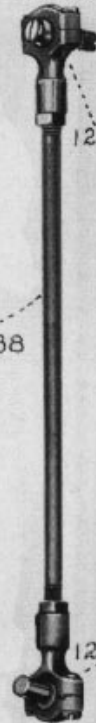

124190



122038

122030



17694



PLATE 9411—ONE-HALF SIZE

122048 122051 122042 58036 49059

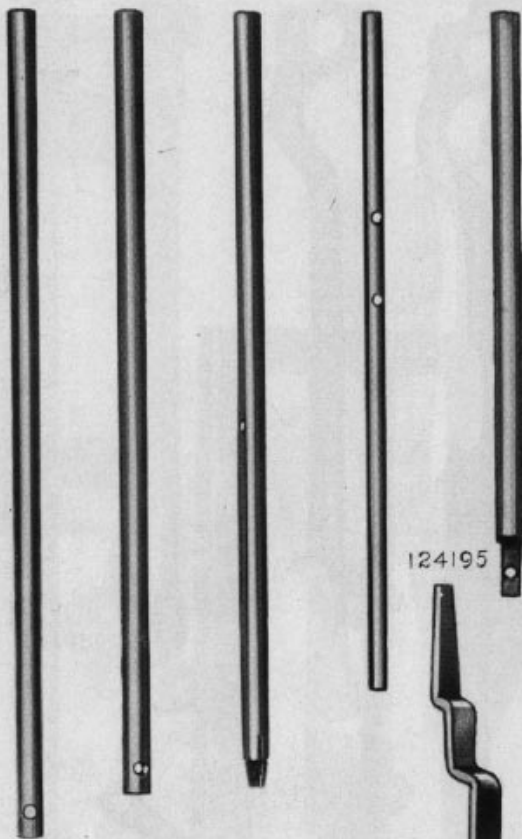

124195



58001

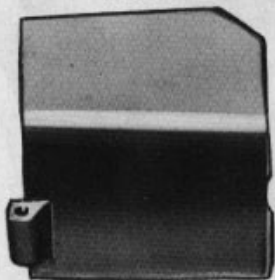
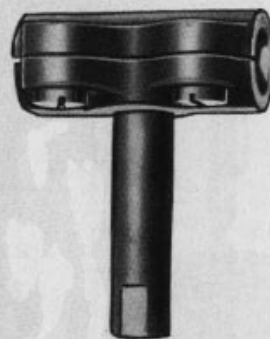

PLATE 9412—FULL SIZE

122040



124172



49051

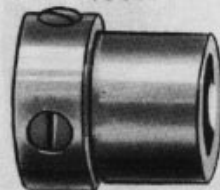

52716



58002



49054



42005



1255



PLATE 9413—FULL SIZE

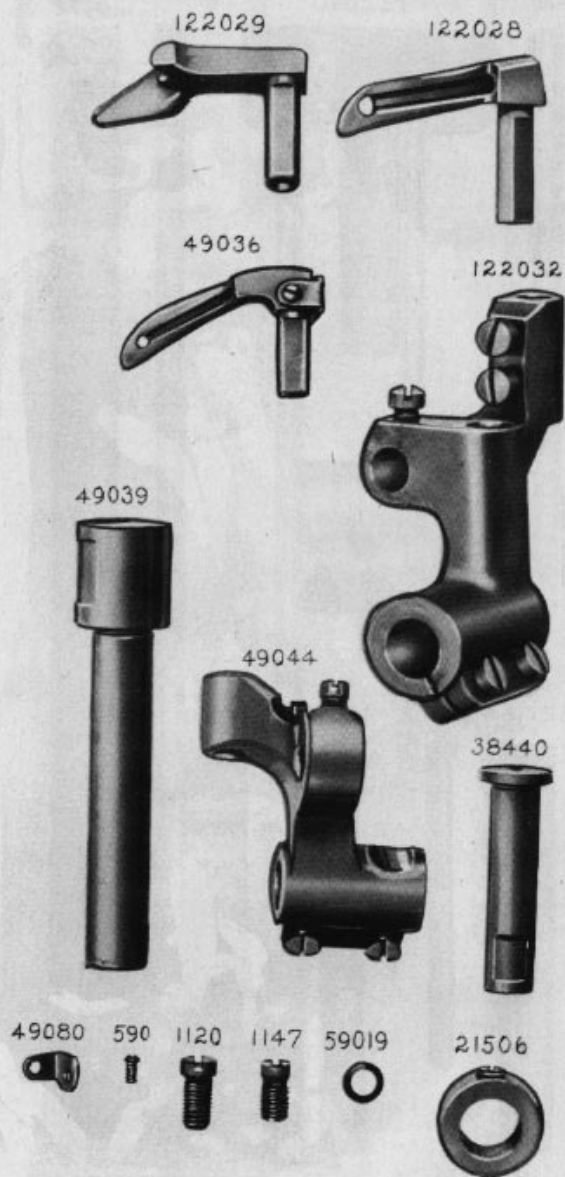

PLATE 9414—FULL SIZE

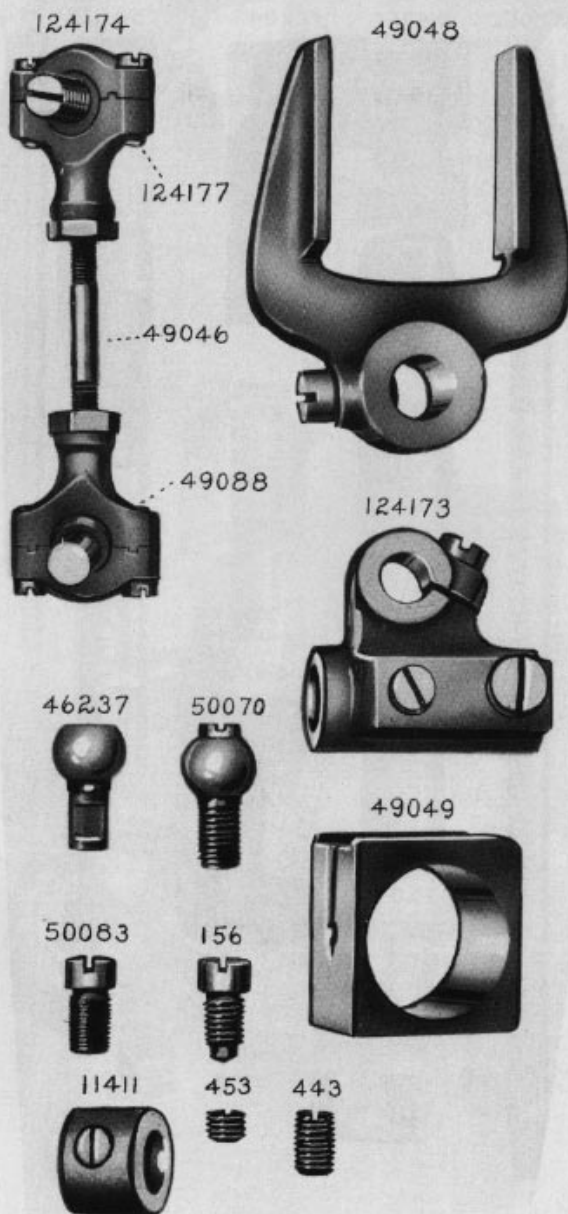

PLATE 9415—FULL SIZE

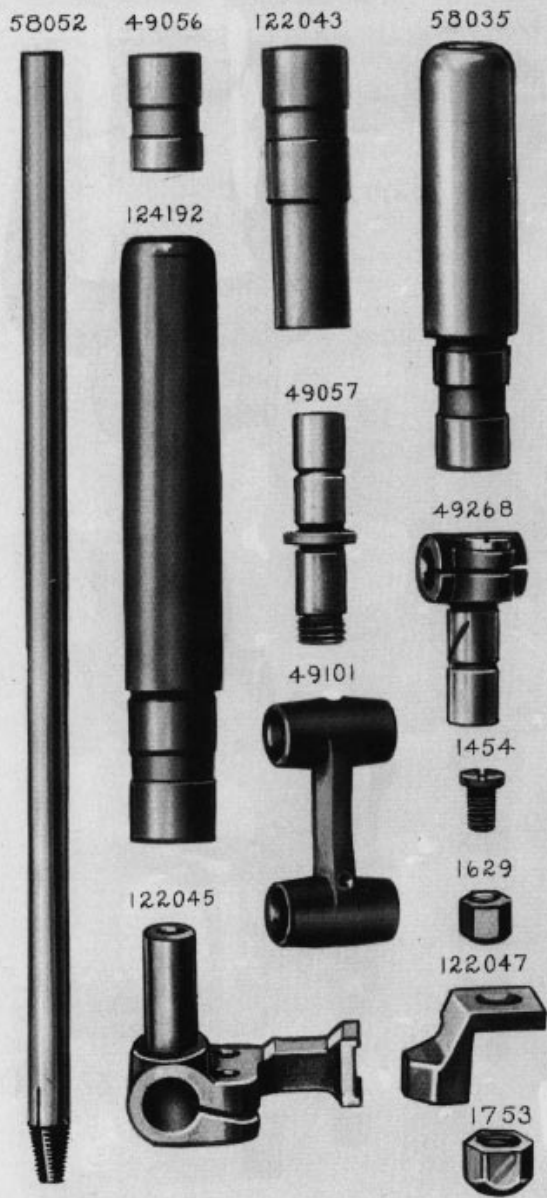

PLATE 9416—ONE-FOURTH SIZE

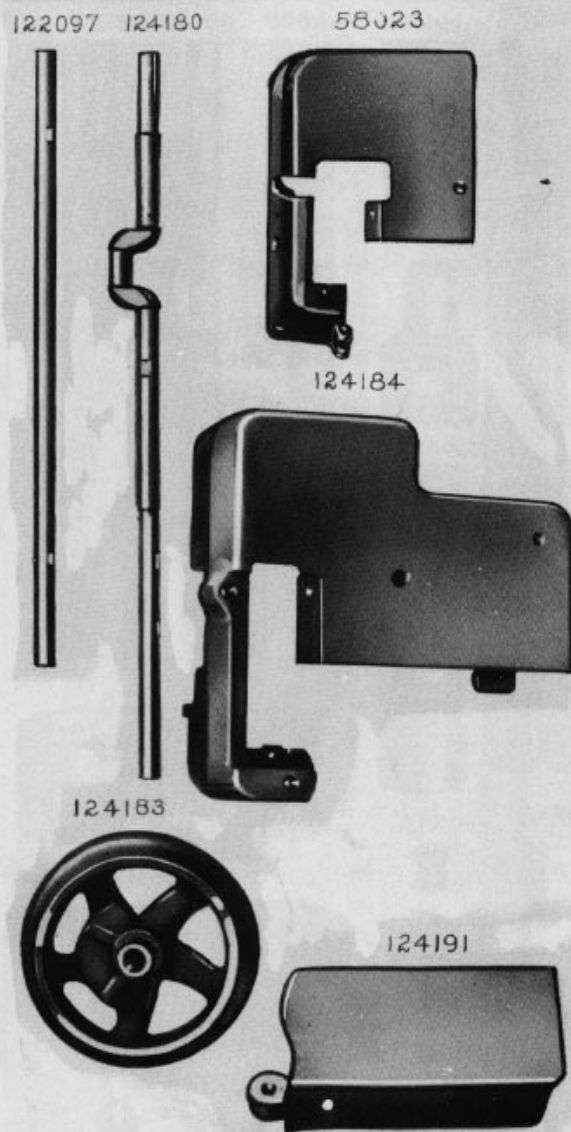

PLATE 9417—FULL SIZE

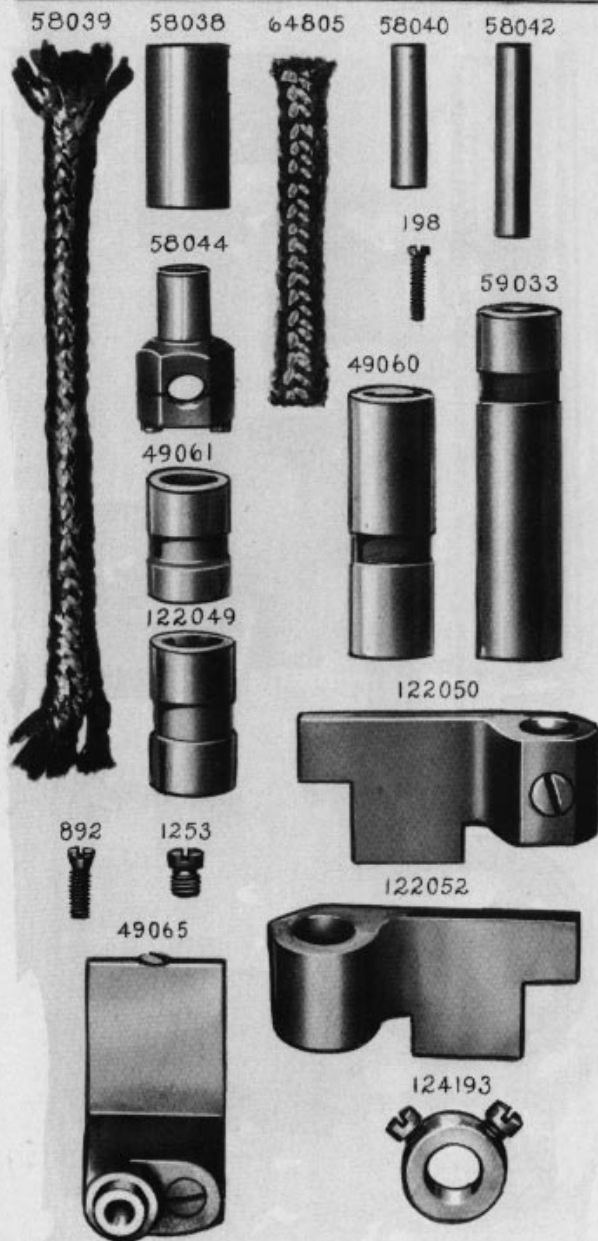

PLATE 9418—FULL SIZE

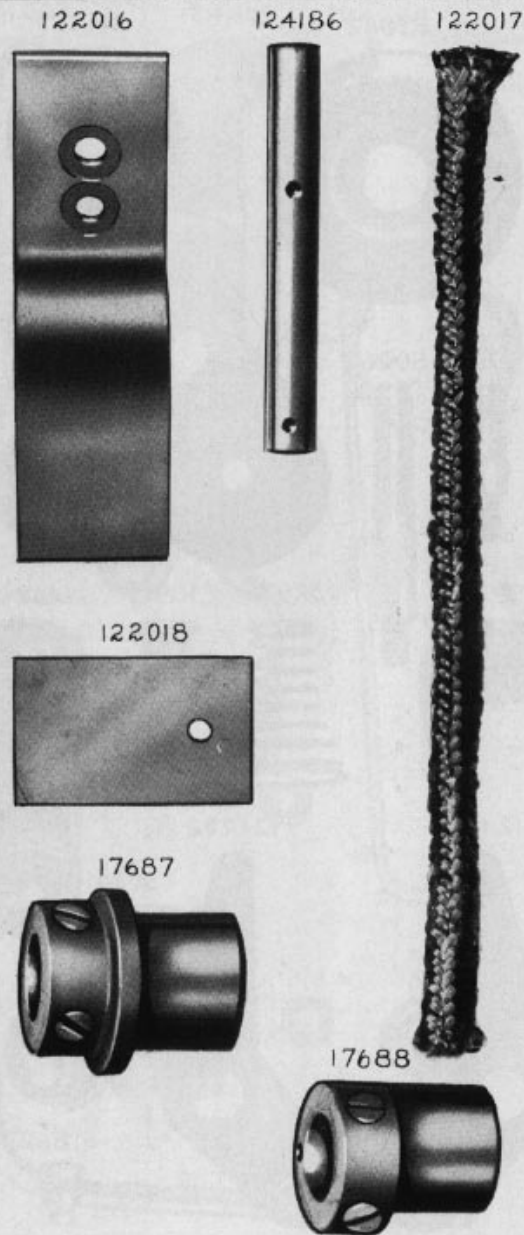

PLATE 9419—FULL SIZE



PLATE 9420—FULL SIZE

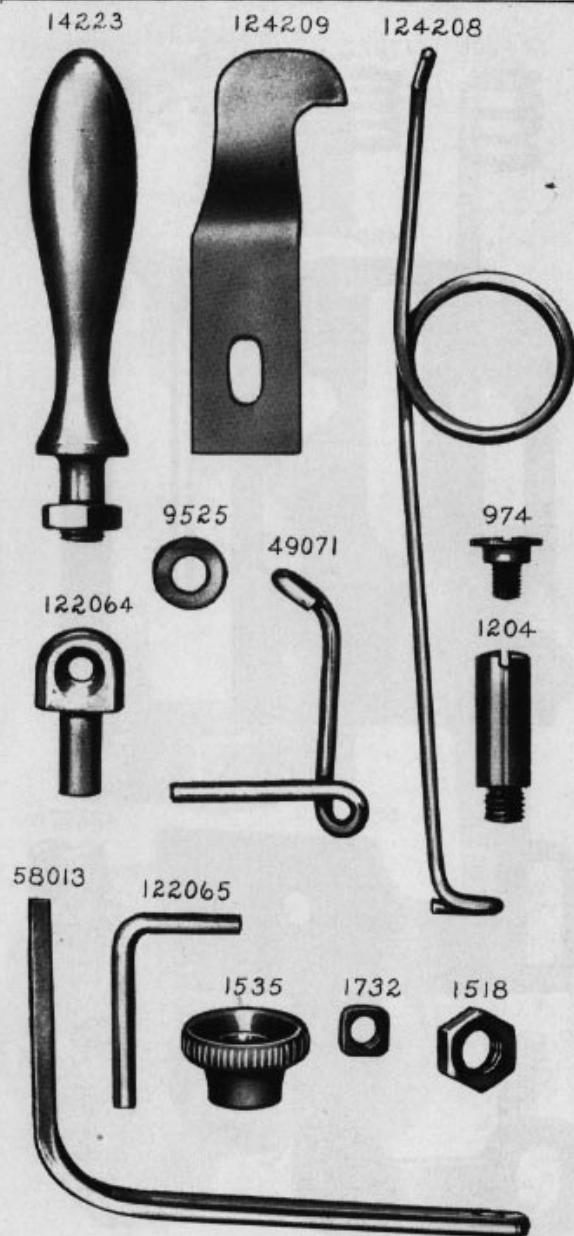

PLATE 9421—FULL SIZE

124206



17622



124205



124171



124204

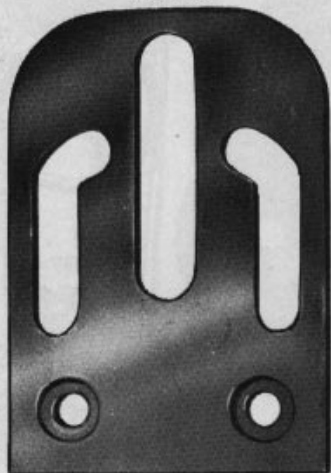

122070



19510



58014



122076



170



122072



PLATE 9422—FULL SIZE

122067

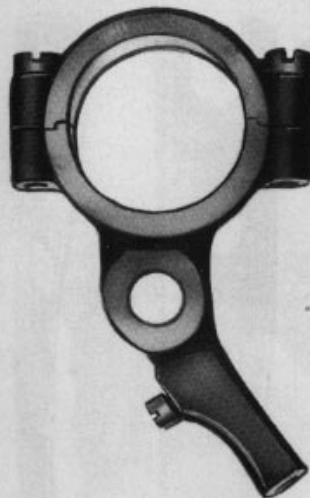

122066



49073



122071



122020

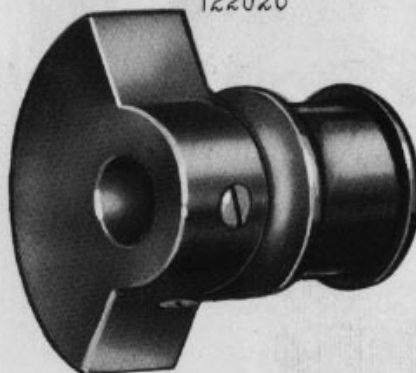

1177



PLATE 9423—FULL SIZE

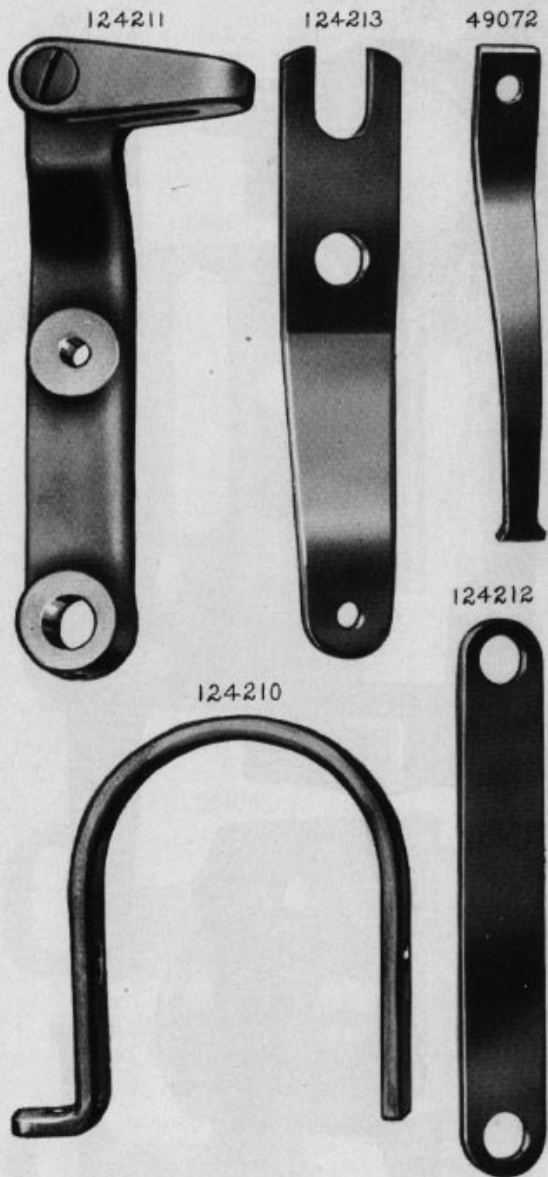

PLATE 9424—FULL SIZE

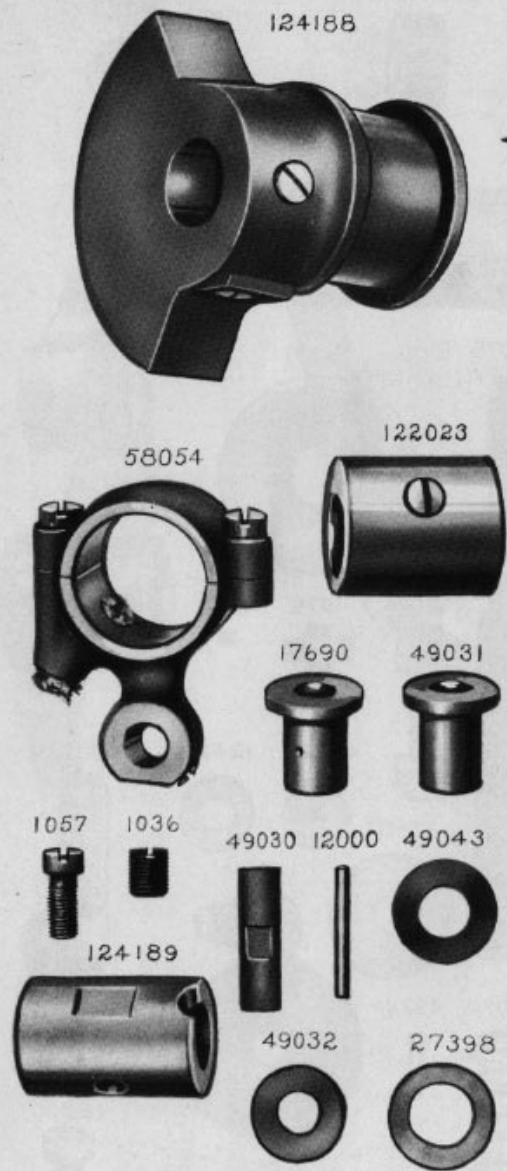

PLATE 9425—FULL SIZE



PLATE 9426—ONE-HALF SIZE

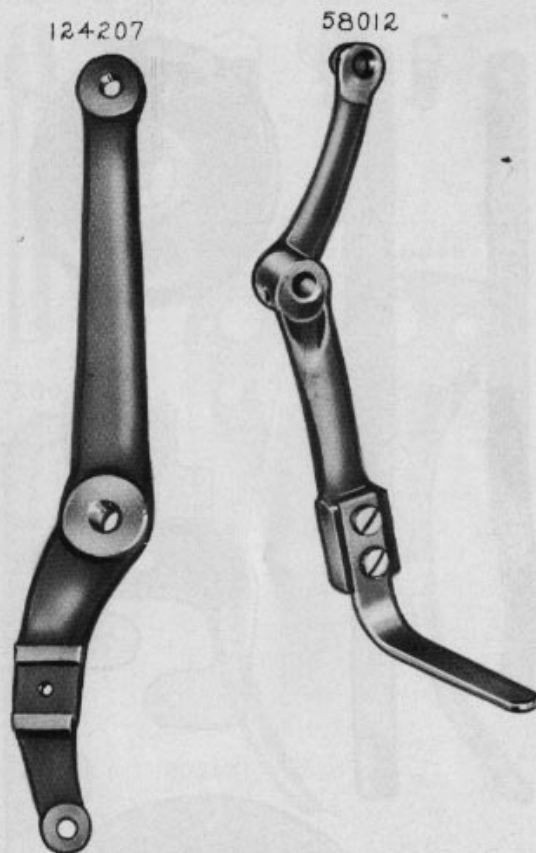

PLATE 9427—ONE-HALF SIZE

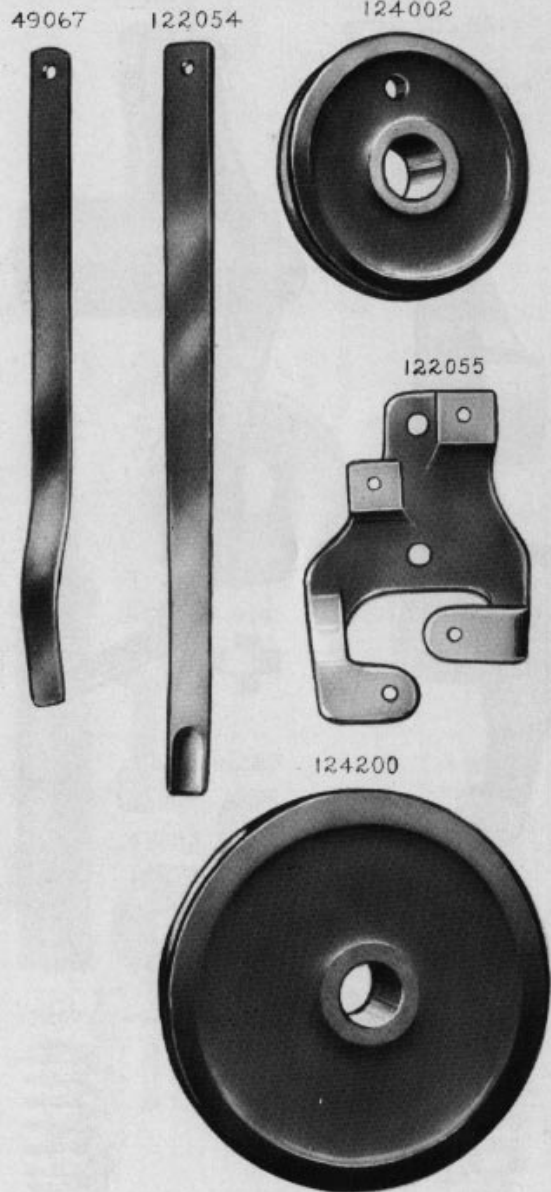
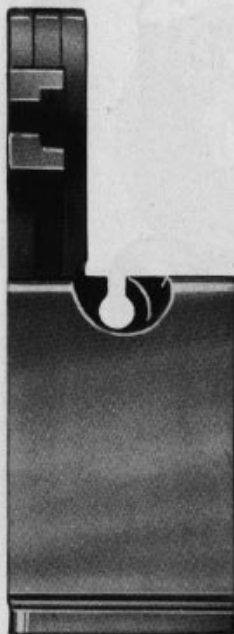

PLATE 9428—FULL SIZE



PLATE 9429—FULL SIZE

124197



124199



124198



233



646



PLATE 9430—FULL SIZE

144



1489



128



690



1396



145



157



896



152



159



898



161



172



704



914



160



158



190



175



171



193



217



226



1147



1279



964



199



212



50086



802



50244

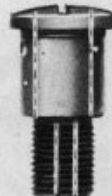

63



PLATE 9431—FULL SIZE



PLATE 9432—ONE-HALF SIZE

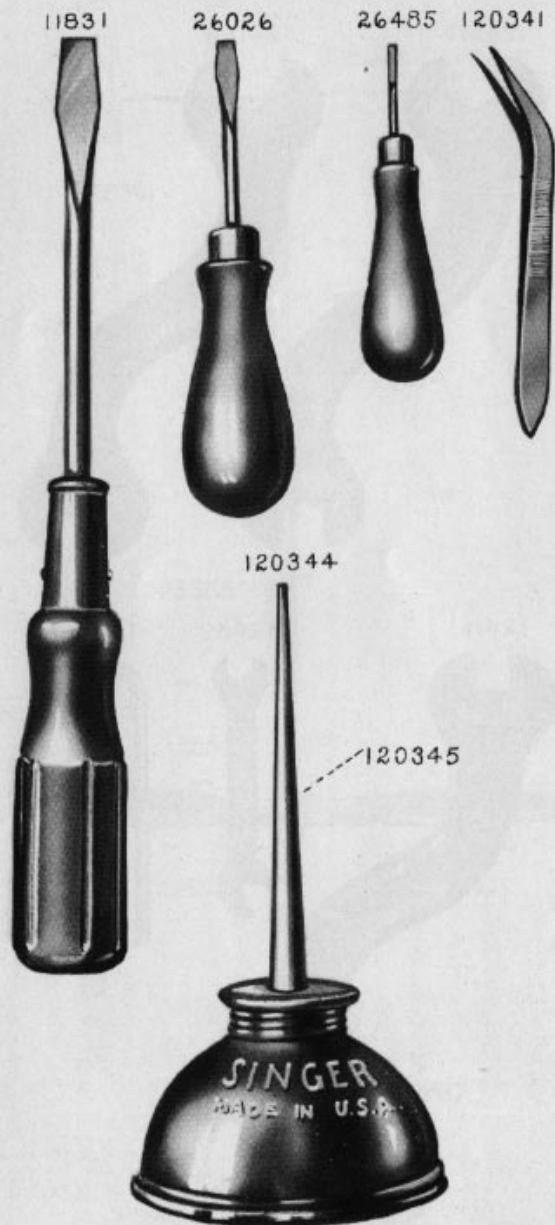

PLATE 9433—ONE-HALF SIZE

124162



124163



124161



42089



124165



PLATE 20335—ONE-SIXTH SIZE

225258



225326

225391

225391

225324

225388

150203

225257

202490

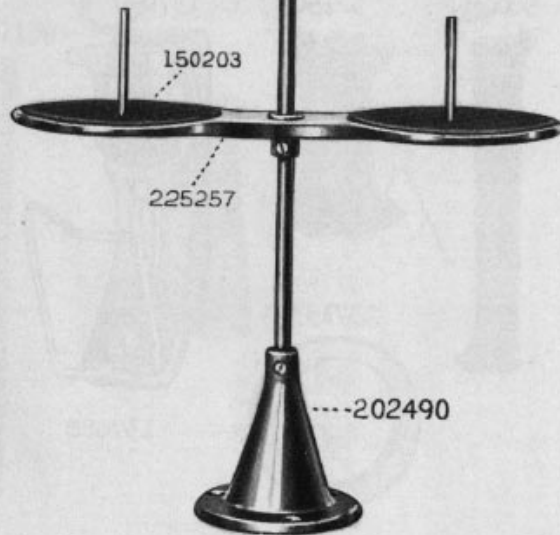

PLATE 21516 - FULL SIZE

8885



51224



51157



140174



201696



225322



201018



200584



200383



208



227



58045



52150



137090

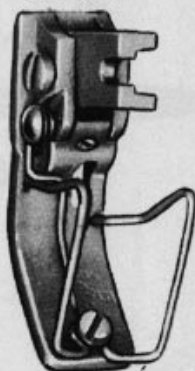

137133

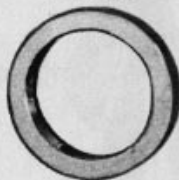

137088

PLATE 21517 - ONE-FOURTH SIZE

120908



122013



49020



124001



137131



137139



27739



225390



PLATE 21518 - ONE-HALF SIZE

8909



8908



25200



27662



137138



49276



122101



17677

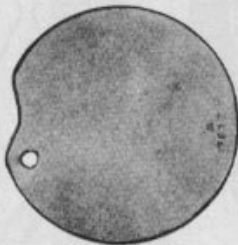

68714

