

SINGER
121W and 122W

1.21 w f

FORM 1223W
REVISED
SEPTEMBER, 1918

PRICE LIST

OF

PARTS

INDEX

	PAGE
ACCESSORIES	54
BOBBIN WINDER	54
FOLDER	61
KNEE LIFTER	55
LAP SEAM EDGE GUIDE	59
“ “ FELLER	59
MACHINE No. 121w1	7
“ “ 121w2	15
“ “ 121w3	22
“ “ 121w4	29
“ “ 122w1	37
“ “ 122w2	46
NUMERICAL LIST OF PARTS	63
OBSOLETE PARTS	61
PRESSER FEET	57
ROLLER WELT GAUGE	60
THROAT PLATES	58



MACHINES

OF

CLASSES 121w and 122w

THE SINGER MANUFACTURING COMPANY

Instructions for Ordering

In ordering from this list, use **ONLY** the **PART** number in the **FIRST** column.

The number stamped on a Sewing Machine Part is the number of the Single Part only, except when the part includes Set Screws, Clamping Screws, Studs and Rollers Spun on, Small Wires riveted, or Parts soldered together, etc., which it is necessary to furnish in combination.

Every combination of parts sent out has its specific number which, although not stamped on Parts (except in above cases) must be used when ordering the combination.

Each number always indicates the **SAME PART** in whatever list it appears, or for whatever Machine.

The letters after some of the numbers indicate the **style of finish** only, as follows:

- A. Hardened, Polished and Plated.
- B. Polished and Plated.
- C. Hardened only.
- D. Polished only.
- E. Soft, not polished.
- F. Hardened and Polished.
- H. Blued.

These letters **MUST BE USED** when they appear in the list and **AFTER** the number, as in the list.

In this series

200001 to 201500 are Screw Numbers.

201501 to 201800 are Nut Numbers.

201801 to 202000 are Roller Numbers.

202001 and upward are numbers of Machine Parts.

The figures in the second column refer only to the plate in which the illustration of the part is shown and are **NOT TO BE USED** in ordering.

Two or more numbers over a cut indicate that the difference between such parts is not visible in an illustration.

Parts marked with an asterisk (*) are furnished only when repairs are made at the factory.

LIST OF PARTS COMPLETE

FOR

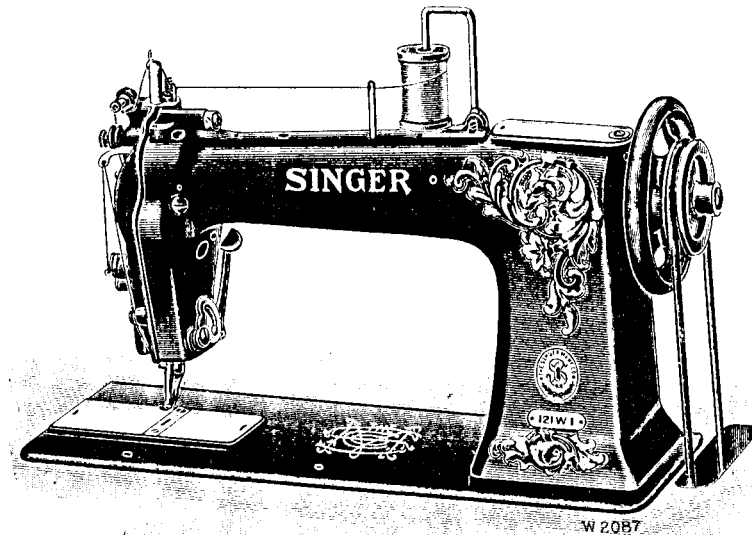

MACHINE No. 121w1

NEEDLE FEED. ALTERNATING PRESSERS.

For Sewing Rough, Uneven or Sticky Goods.

No.	Plate	Name	Each
*213451	—	Arm	\$ —
202247	11055	" Cap	35
200278H	12311	" " Screw	05
202248	11701	" " Washer	05
204235	11701	" Position Pin (2)	02
200004E	11063	" Screw (3)	08
202005	11701	" " Washer (3)	01
213491	11183	" Shaft	1 75
202243	11055	" " Bushing (back) with 202244	75
202244	—	Arm Shaft Bushing (back) Oil Packing (wick)	02
200338C	11701	Arm Shaft Bushing (back) Set Screw	04
213452	11055	Arm Shaft Bushing (front) with 202260	35

No.	Plate	Name	Each
202260	—	Arm Shaft Bushing (front) Oil Packing (wick)	\$ 01
200352c	11701	Arm Shaft Bushing (front) Set Screw	03
213453	11055	Arm Shaft Connection Belt	1 00
213454	11055	" " " " Pulley with 200363c, 200396c and two 213455	1 25
200396c	11701	Arm Shaft Connection Belt Pulley Position Screw	03
200363c	11701	Arm Shaft Connection Belt Pulley Set Screw	03
213455	11063	Arm Shaft Connection Belt Pulley Spring Flange	20
213492	11055	Arm Shaft Counter Balance with 200347c	25
200347c	11063	Arm Shaft Counter Balance Set Screw	03
213471	11183	Balance Wheel (belt groove 2 3/4 in. diam.) with two 200335c	1 00
200062H	12311	Balance Wheel Adjusting Screw ..	07
200335c	12311	" " Set Screw	04
*213468	—	Bed	—
202258	12153	" Hinge Connection (2)	08
200570E	12311	" " " Screw (4)	05
213477	11055	" Slide (back) with 213478 and 213479	60
213476	11055	Bed Slide (front) with 213478 and 213479	60
213478	11063	Bed Slide Friction Slide	10
213479	11063	" " " Spring	02
213783	11064	Bobbin	08
*213444	—	" Case	—
203648	11703	" " Latch	10
*202056	11703	" " " Pin	—
213932	11703	" " " Plunger	10
203474	11703	" " " Spring	01
213446	11064	" " Lever	1 00
213447	11064	" " " Arm with 200099H	30
200099H	11703	" " " " Pinch Screw	02
213445	11064	" " Tension Spring	10
200984c	11703	" " " " Regulat- ing Screw	04
200594c	11703	Bobbin Case Tension Spring Screw ..	02
213689	11064	Bobbin Case complete, Nos. 200594c, 200984c, 202056, 203474, 203648, 213444, 213445 and 213932	1 00
221580	—	Face Plate with 200368H, 200739F, 202087, 202090, 213691 and four 200397H	1 50

No.	Plate	Name	Each
200053c	12311	Face Plate Screw (2)	\$ 04
200739F	11063	" " Thread Guide Screw ..	08
221581	11183	Face Plate complete, Nos. 200577H, 202088, 204272, 204280, 210957, 210958, 210992, 210993, 213500, 213690, 221580 and two 200309E ..	3 25
213464	11063	Feed Cam	75
213692	11066	" " Position Pin (2)	02
201827	11063	" " Roller	12
201821	—	" " " 201827 with 200818c ..	30
200818c	11066	" " " Screw Stud	15
201522E	11701	" " " " Nut ..	03
200035E	11066	" " Screw	05
213465	11066	" Connection	40
213466	11066	" " Link	50
213467	11066	" " " Lever	50
200101D	11066	" " Stop Screw	04
213463	11066	" Eccentric Connection with 200094F	1 00
200094F	11701	Feed Eccentric Connection Pinch Screw	02
213460	11702	Feed and Needle Carrying Frame with 213711	1 50
221569	—	Feed and Needle Carrying Frame 213460 with 200101D, 201522E, 201821, 213461, 213463 to 213467, 213473 to 213475, 213481, 213483, 213485 to 213488, 213673 and two 213484	15 75
213711	11701	Feed and Needle Carrying Frame Bushing	10
213639	11078	Feed and Needle Carrying Frame Collar with 200380c	15
200380c	12319	Feed and Needle Carrying Frame Collar Set Screw	02
213461	11067	Feed and Needle Carrying Frame Link	75
213494	11067	Feed Regulating Lever	60
213696	11067	" " " Friction Washer	10
200095B	11067	Feed Regulating Lever Screw	04
213496	11067	" " " Segment	25
201183D	11063	" " " Screw	04
200681c	11067	" " " Stop Screw	04
*221550	—	Hook (sewing)	—
221551	11703	" 221550 with 200088F, 213438 and 213644	5 00
221554	—	Hook and Bobbin Case complete, Nos. 213689 and 221551	6 00

No.	Plate	Name	Each
213440	11064	Hook Bushing (lower)	\$ 25
213439	11064	" " (upper)	25
200378c	12311	" " Set Screw	02
213441	11064	" Driving Gear with two 200383c	1 00
200383c	12311	" " " Set Screw	02
213493	11707	" " Shaft	1 00
213469	11702	" " " Bearing with 200027E	35
213470	11064	Hook Driving Shaft Bearing Bush- ing	25
200027E	11703	Hook Driving Shaft Bearing Bush- ing Clamp Screw	04
200019E	11064	Hook Driving Shaft Bearing Screw (2)	06
213443	11064	Hook Driving Shaft Bushing	25
200027E	11703	" " " " Clamp Screw	04
202574	11703	Hook Driving Shaft Collar with 200380c	15
200380c	12319	Hook Driving Shaft Collar Set Screw	02
221576	11069	Hook Driving Shaft Connection Belt Pulley with 202324 and two 201421c	75
201421c	11063	Hook Driving Shaft Connection Belt Pulley Set Screw	04
202324	11063	Hook Driving Shaft Connection Belt Pulley Spring Flange	08
221552	11703	Hook Gear with 200397c	1 00
221553	11703	" " Key	10
200397c	12349	" " Set Screw	02
*213438	—	" Gib	—
*213644	—	" " Hinge Pin	—
200088F	11064	" " Screw	02
213442	11069	" Saddle with 200027E and two 200378c	2 50
200019E	11064	Hook Saddle Screw (2)	06
202622	11703	" " " Washer (2) ...	01
221555	11704	Hook Saddle complete, Nos. 213439, 213440, 213442, 213446, 213447 and 221552 to 221554	11 00
202445	11707	Knee Lifter Connection Lever with 202446	07
213871	—	Knee Lifter Connection Lever 202445 with 200224H, 200262H, 213869 and 213870	55
200224H	11701	Knee Lifter Connection Lever Hinge Screw	12
213870	11707	Knee Lifter Connection Lever Lift- ing Rod with 202302	08

No.	Plate	Name	Each
202302	11063	Knee Lifter Connection Lever Lift- ing Rod Cotter Pin	\$ 01
202446	11701	Knee Lifter Connection Lever Pin	03
213869	11707	" " Lifting Lever	20
200262H	11701	" " " " Hinge Screw	10
213480	11185	Lifting Presser Bar with 200074F..	85
213481	11070	" " " Collar with 200572F and two 200386c	1 00
200386c	11701	Lifting Presser Bar Collar Set Screw	02
200572F	11070	" " " " Slide Ad- justing Screw	04
200490B	11070	Lifting Presser Bar Sleeve Screw and Nut	35
213482	11070	Lifting Presser Bar Spring	10
200635B	11070	" " " " Follower Screw	25
200613F	11701	Lifting Presser Bar Spring Follower Screw Position Screw	03
214057	—	Lifting Presser Bar Vibrating Lever	1 10
213483	11070	" " " " " " 214057 with 200230F and 201525E	1 25
200230F	11070	Lifting Presser Bar Vibrating Lever Hinge Screw	10
201525E	11701	Lifting Presser Bar Vibrating Lever Hinge Screw Nut	03
213485	11071	Lifting Presser Bar Vibrating Lever Rocker Arm	1 00
213486	11071	Lifting Presser Bar Vibrating Lever Rocker Arm Link	75
213484	11071	Lifting Presser Bar Vibrating Lever Slide Block	25
229755	11080	Lifting Presser Foot	1 00
200074F	11701	" " " " Screw	03
213473	11185	Needle Bar (hollow) with 200125F	1 00
213474	11071	" " Collar with 200049F and 200572F	50
200049F	11071	Needle Bar Collar Set Screw	03
200572F	11070	" " " " Slide Adjusting Screw	04
213475	11071	Needle Bar Connecting Link	75
200125F	11701	" Set Screw	02
202554	11701	Presser Bar Lifter	25
200026D	11071	" " " Hinge Screw ..	04
213490	11071	" " " Shoe and Ten- sion Release Stud	40
202068	12153	Spool Holder Base	15
200575H	12311	" " " Screw	05
204296	12153	" " Wire	10
200079H	12311	" " " Hinge Screw	02

No.	Plate	Name	Each
204297	12153	Spool Holder complete, Nos. 200079H, 202068 and 204296	\$ 25
213673	11702	Take-up Cam with 200335c, 200383c and 200430c	2 25
200430c	12311	Take-up Cam Position Screw	08
200383c	12311	" " " " Check Screw	02
200335c	12311	Take-up Cam Set Screw	04
213498	11705	" Lever	1 00
221572	—	" " 213498 with 213697	1 15
213697	11071	" " Bearing with 204264	15
204264	11705	" " " Position Pin	01
200042F	12311	" " " Screw	05
201816	11705	" " Roller	12
213499	11705	Take-up Lever complete, Nos. 200042F, 201816 and 221572	1 25
202402	12349	Tension Disc	05
202090	12349	" " Position Pin	01
213500	11072	" Release Lever	10
200309E	12349	" " " Screw	04
202075	12349	" " Plunger	03
202407	12349	" Spring	05
200632B	12349	" Stud	20
200397H	12349	" " Set Screw	02
201572B	12349	" Thumb Nut	04
204271	12349	" Washer	05
204272	12349	Tension complete, Nos. 200632B, 201572B, 202075, 202107, 204271 and two 202402	50
204274	12349	Thread Controller Plate	12
200577H	12311	" " " Screw	02
202098	12349	" " Roller	05
204275	12349	" " " Guard	10
202084	12349	" " " Washer	01
200300c	12349	" " " Screw	04
204276	12349	" " Spring	03
204333	12349	" " " Guard	08
200581H	12349	" " " Screw	02
202087	12349	" " " Stop	03
202088	12349	" " " Stud with 204925	10
200368H	12349	Thread Controller Spring Stud Set Screw	02
204925	11703	Thread Controller Spring Stud Washer	01
205987	12349	Thread Controller complete, Nos. 200300c, 200581H, 202098, 204274, 204275 and 204333	42

No.	Plate	Name	Each
204280	12349	Thread Controller and Spring complete, Nos. 204276 and 205987	\$ 45
213448	11072	Thread Draw	15
213614	11072	" " Driving Fork Lever with 200389H	60
213501	11072	Thread Draw Driving Fork Lever Eccentric with 200366H	75
200366H	12349	Thread Draw Driving Fork Lever Eccentric Set Screw	02
200389H	11701	Thread Draw Driving Fork Lever Set Screw	02
213450	11072	Thread Draw Driving Shaft	15
213613	11071	" " " " Collar with 200389H	10
200389H	11701	Thread Draw Driving Shaft Collar Set Screw	02
213449	11073	Thread Draw Lever with two each 200355H and 200397H	75
200355H	12319	Thread Draw Lever Adjusting Screw	03
200397H	12349	Thread Draw Lever Set Screw	02
200397H	12349	" " Set Screw	02
202412	11703	" Guide	06
213489	11073	" " "	10
200389c	11701	" " Set Screw	02
202482	12319	" Retainer Disc	02
213691	11072	" " Guide Wire	05
200397H	12349	" " " " Set Screw	02
210993	11063	" " Sleeve	05
202483	12319	" " Spring (brass)	01
210992	11063	" " " "	01
200631E	11072	" " Stud	10
210957	11063	" " " "	12
210958	11063	" " " Collar	08
201574D	11072	" " " Nut	03
200397H	12349	" " " Set Screw	02
213690	11072	Thread Retainer complete, Nos. 200631E, 201574D, 202483 and two 202482	20
212841	11074	Throat Plate, 53 needle hole, for needle sizes 10 to 20	80
200577H	12311	Throat Plate Screw (2)	02
213487	11185	Vibrating Presser Bar with 200389c	60
213488	11073	" " " Collar with 200386c and 200572F	40
200386c	11701	Vibrating Presser Bar Collar Set Screw	02
200572F	11070	Vibrating Presser Bar Collar Slide Adjusting Screw	04

No.	Plate	Name	Each
213484	11071	Vibrating Presser Bar Collar Slide Block	\$ 25
213489	11073	Vibrating Presser Bar Thread Guide	10
200389c	11701	" " " " " "	
		Set Screw	02
229751	11079	Vibrating Presser Foot, 46 needle hole, with 200941c	1 25
200941c	11701	Vibrating Presser Foot Pinch Screw	03

LIST OF PARTS COMPLETE

FOR

MACHINE No. 121w2

NEEDLE FEED. ALTERNATING PRESSERS.

For Sewing and Binding Mackintoshes, Rubber Overcoats,
etc.

No.	Plate	Name	Each
*213451	—	Arm	\$ —
202247	11055	" Cap	35
200278H	12311	" " Screw	05
202248	11701	" " " Washer	05
204235	11701	" Position Pin (2)	02
200004E	11063	" Screw (3)	08
202005	11701	" " Washer (3)	01
213491	11183	" Shaft	1 75
202243	11055	" " Bushing (back) with 202244	75
202244	—	Arm Shaft Bushing (back) Oil Packing (wick)	02
200338c	11701	Arm Shaft Bushing (back) Set Screw	04
213452	11055	Arm Shaft Bushing (front) with 202260	35
202260	—	Arm Shaft Bushing (front) Oil Packing (wick)	01
200352c	11701	Arm Shaft Bushing (front) Set Screw	03
213453	11055	Arm Shaft Connection Belt	1 00
213454	11055	" " " " Pulley with 200363c, 200396c and two 213455	1 25
200396c	11701	Arm Shaft Connection Belt Pulley Position Screw	03
200363c	11701	Arm Shaft Connection Belt Pulley Set Screw	03
213455	11063	Arm Shaft Connection Belt Pulley Spring Flange	20
213492	11055	Arm Shaft Counter Balance with 200347c	25
200347c	11063	Arm Shaft Counter Balance Set Screw	03
213471	11183	Balance Wheel (belt groove 2 3/4 in. diam.) with two 200335c	1 00

No.	Plate	Name	Each
200027E	11703	Hook Driving Shaft Bearing Bushing Clamp Screw	\$ 04
200019E	11064	Hook Driving Shaft Bearing Screw (2)	06
213443	11064	Hook Driving Shaft Bushing	25
200027E	11703	" " " " Clamp Screw	04
202574	11703	Hook Driving Shaft Collar with 200380c	15
200380c	12319	Hook Driving Shaft Collar Set Screw	02
221576	11069	Hook Driving Shaft Connection Belt Pulley with 202324 and two 201421c	75
201421c	11063	Hook Driving Shaft Connection Belt Pulley Set Screw	04
202324	11063	Hook Driving Shaft Connection Belt Pulley Spring Flange	08
221552	11703	Hook Gear with 200397c	1 00
221553	11703	" " Key	10
200397c	12349	" " Set Screw	02
*213438	—	" " Gib	—
*213644	—	" " Hinge Pin	—
200088F	11064	" " Screw	02
213442	11069	" Saddle with 200027E and two 200378c	2 50
200019E	11064	Hook Saddle Screw (2)	06
202622	11703	" " " Washer (2) ..	01
221555	11704	Hook Saddle complete, Nos 213439, 213440, 213442, 213446, 213447 and 221552 to 221554	11 00
202445	11707	Knee Lifter Connection Lever with 202446	07
221567	—	Knee Lifter Connection Lever 202445 with 200217H, 200224H, 213869 and 213870	60
200224H	11701	Knee Lifter Connection Lever Hinge Screw	12
213870	11707	Knee Lifter Connection Lever Lifting Rod with 202302	08
202302	11063	Knee Lifter Connection Lever Lifting Rod Cotter Pin	01
202446	11701	Knee Lifter Connection Lever Pin	03
213869	11707	" " Lifting Lever	20
213480	11185	Lifting Presser Bar with 200074F ..	85
213481	11070	" " " Collar with 200572F and two 200386c	1 00
200386c	11701	Lifting Presser Bar Collar Set Screw	02

No.	Plate	Name	Each
200572F	11070	Lifting Presser Bar Collar Slide Adjusting Screw	\$ 04
200490B	11070	Lifting Presser Bar Sleeve Screw and Nut	35
213482	11070	Lifting Presser Bar Spring	10
200635B	11070	" " " " Follower Screw	25
200613F	11701	Lifting Presser Bar Spring Follower Screw Position Screw	03
214057	—	Lifting Presser Bar Vibrating Lever	1 10
213483	11070	" " " " "	
		214057 with 200230F and 201525E	1 25
200230F	11070	Lifting Presser Bar Vibrating Lever Hinge Screw	10
201525E	11701	Lifting Presser Bar Vibrating Lever Hinge Screw Nut	03
213485	11071	Lifting Presser Bar Vibrating Lever Rocker Arm	1 00
213486	11071	Lifting Presser Bar Vibrating Lever Rocker Arm Link	75
213484	11071	Lifting Presser Bar Vibrating Lever Slide Block	25
229755	11080	Lifting Presser Foot	1 00
200074F	11701	" " " Screw	03
213473	11185	Needle Bar (hollow) with 200125F ..	1 00
213474	11071	" " Collar with 200049F and 200572F	50
200049F	11071	Needle Bar Collar Set Screw	03
200572F	11070	" " " Slide Adjusting Screw	04
213475	11071	Needle Bar Connecting Link	75
200125F	11701	" " Set Screw	02
202554	11701	Presser Bar Lifter	25
200026D	11071	" " " Hinge Screw ..	04
213490	11071	" " " Shoe and Tension Release Stud	40
202068	12153	Spool Holder Base	15
200575H	12311	" " " Screw	05
204296	12153	" " Wire	10
200079H	12311	" " " Hinge Screw	02
204297	12153	Spool Holder complete, Nos. 200079H, 202068 and 204296	25
213673	11702	Take-up Cam with 200335c, 200383c and 200430c	2 25
200430c	12311	Take-up Cam Position Screw	08
200383c	12311	" " " " Check Screw	02
200335c	12311	Take-up Cam Set Screw	04
213498	11705	" Lever	1 00
221572	—	" " 213498 with 213697 ..	1 15

Parts for Machine No. 121w2

19

No.	Plate	Name	Each
200572F	11070	Lifting Presser Bar Collar Slide Adjusting Screw	\$ 04
200490B	11070	Lifting Presser Bar Sleeve Screw and Nut	35
213482	11070	Lifting Presser Bar Spring	10
200635B	11070	" " " " Follower Screw	25
200613F	11701	Lifting Presser Bar Spring Follower Screw Position Screw	03
214057	—	Lifting Presser Bar Vibrating Lever	1 10
213483	11070	" " " " " 214057 with 200230F and 201525E	1 25
200230F	11070	Lifting Presser Bar Vibrating Lever Hinge Screw	10
201525E	11701	Lifting Presser Bar Vibrating Lever Hinge Screw Nut	03
213485	11071	Lifting Presser Bar Vibrating Lever Rocker Arm	1 00
213486	11071	Lifting Presser Bar Vibrating Lever Rocker Arm Link	75
213484	11071	Lifting Presser Bar Vibrating Lever Slide Block	25
229755	11080	Lifting Presser Foot	1 00
200074F	11701	" " " Screw	03
213473	11185	Needle Bar (hollow) with 200125F ..	1 00
213474	11071	" " Collar with 200049F and 200572F	50
200049F	11071	Needle Bar Collar Set Screw	03
200572F	11070	" " " Slide Adjusting Screw	04
213475	11071	Needle Bar Connecting Link	75
200125F	11701	" Set Screw	02
202554	11701	Presser Bar Lifter	25
200026D	11071	" " " Hinge Screw ..	04
213490	11071	" " " Shoe and Ten- sion Release Stud	40
202068	12153	Spool Holder Base	15
200575H	12311	" " " Screw	05
204296	12153	" " Wire	10
200079H	12311	" " " Hinge Screw	02
204297	12153	Spool Holder complete, Nos. 200079H, 202068 and 204296	25
213673	11702	Take-up Cam with 200335c, 200383c and 200430c	2 25
200430c	12311	Take-up Cam Position Screw	08
200383c	12311	" " " " Check Screw	02
200335c	12311	Take-up Cam Set Screw	04
213498	11705	" Lever	1 00
221572	—	" " 213498 with 213697 ..	1 15

Parts for Machine No. 121 v2

21

No.	Plate	Name	Each
213613	11071	Thread Draw Driving Shaft Collar with 200389H	\$ 10
200389H	11701	Thread Draw Driving Shaft Collar Set Screw	02
213449	11073	Thread Draw Lever with two each 200355H and 200397H	75
200355H	12319	Thread Draw Lever Adjusting Screw	03
200397H	12349	Thread Draw Lever Set Screw	02
260397H	12349	" " Set Screw	02
202412	11703	" Guide	06
213489	11073	" "	10
200389c	11701	" " Set Screw	02
202482	12319	" Retainer Disc	02
213691	11072	" " Guide Wire	05
200397H	12349	" " " Set Screw	02
210993	11063	" " Sleeve	05
202483	12319	" " Spring (brass)	01
210992	11063	" " "	01
200631E	11072	" " Stud	10
210957	11063	" " "	12
210958	11063	" " " Collar	08
201574D	11072	" " " Nut	03
200397H	12349	" " " Set Screw	02
213690	11072	Thread Retainer complete, Nos. 200631E, 201574D, 202483 and two 202482	20
212841	11074	Throat Plate, 53 needle hole, for needle sizes 10 to 20	80
200577H	12311	Throat Plate Screw (2)	02
213487	11185	Vibrating Presser Bar with 200389c	60
213488	11073	" " " Collar with 200386c and 200572F	40
200386c	11701	Vibrating Presser Bar Collar Set Screw	02
200572F	11070	Vibrating Presser Bar Collar Slide Adjusting Screw	04
213484	11071	Vibrating Presser Bar Collar Slide Block	25
213489	11073	Vibrating Presser Bar Thread Guide	10
200389c	11701	" " " " " Set Screw	02
229751	11079	Vibrating Presser Foot, 46 needle hole, with 200941c	1 25
200941c	11701	Vibrating Presser Foot Pinch Screw	03

LIST OF PARTS COMPLETE

FOR

MACHINE No. 121w3

NEEDLE FEED. ALTERNATING PRESSERS.

For Pocket Books.

No.	Plate	Name	Each
*213510	—	Arm	\$ —
202247	11055	" Cap	35
200278H	12311	" " Screw	05
202248	11701	" " " Washer	05
204235	11701	" Position Pin (2)	02
200004E	11063	" Screw (3)	08
202005	11701	" " Washer (3)	01
213491	11183	" Shaft	1 75
202243	11055	" " Bushing (back) with 202244	75
202244	—	Arm Shaft Bushing (back) Oil Packing (wick)	02
200338c	11701	Arm Shaft Bushing (back) Set Screw	04
213452	11055	Arm Shaft Bushing (front) with 202260	35
202260	—	Arm Shaft Bushing (front) Oil Packing (wick)	01
200352c	11701	Arm Shaft Bushing (front) Set Screw	03
213453	11055	Arm Shaft Connection Belt	1 00
213454	11055	" " " " Pulley with 200363c, 200396c and two 213455	1 25
200396c	11701	Arm Shaft Connection Belt Pulley Position Screw	03
200363c	11701	Arm Shaft Connection Belt Pulley Set Screw	03
213455	11063	Arm Shaft Connection Belt Pulley Spring Flange	20
213492	11055	Arm Shaft Counter Balance with 200347c	25
200347c	11063	Arm Shaft Counter Balance Set Screw	03
213471	11183	Balance Wheel (belt groove 2 3/4 in. diam.) with two 200335c	1 00

No.	Plate	Name	Each
200062H	12311	Balance Wheel Adjusting Screw ..	\$ 07
200335c	12311	" " " Set Screw	04
*213468	—	Bed	—
202258	12153	" Hinge Connection (2)	08
200570E	12311	" " " Screw (4)	05
213477	11055	" Slide (back) with 213478 and 213479	60
213476	11055	Bed Slide (front) with 213478 and 213479	60
213478	11063	Bed Slide Friction Slide	10
213479	11063	" " " " Spring ...	02
213783	11064	Bobbin	08
*213444	—	" Case	—
203648	11703	" " Latch	10
*202056	11703	" " " Pin	—
213932	11703	" " " Plunger	10
203474	11703	" " " Spring	01
213446	11064	" " Lever	1 00
213447	11064	" " " Arm with 200099H	30
200099H	11703	" " " " Pinch Screw	02
213445	11064	" " Tension Spring	10
200984c	11703	" " " " Regulat- ing Screw	04
200594c	11703	Bobbin Case Tension Spring Screw	02
213689	11064	Bobbin Case complete, Nos. 200594c, 200984c, 202056, 203474, 203648, 213444, 213445 and 213932	1 00
221580	—	Face Plate with 200368H, 200739E, 202087, 202090, 213691 and four 200397H	1 50
200053c	12311	Face Plate Screw (2)	04
200739E	11063	" " Thread Guide Screw ..	08
221581	11183	Face Plate complete, Nos. 200577H, 202088, 204272, 204280, 210957, 210958, 210992, 210993, 213500, 213690, 221580 and two 200309E ..	3 25
213464	11063	Feed Cam	75
213692	11066	" " Position Pin (2)	02
201827	11063	" " Roller	12
201821	—	" " " 201827 with 200818c	30
200818c	11066	" " " Screw Stud	15
201522E	11701	" " " " " Nut..	03
200035E	11066	" " Screw	05
213465	11066	" Connection	40
213466	11066	" " Link	50
213511	11078	" " Lever	50
200101D	11066	" " Stop Screw	04
213463	11066	" Eccentric Connection with 200094F	1 00

No.	Plate	Name	Each
200094r	11701	Feed Eccentric Connection Pinch Screw	\$ 02
213460	11702	Feed and Needle Carrying Frame with 213711	1 50
221570	---	Feed and Needle Carrying Frame 213460 with 200101b, 201522e, 201821, 213461, 213463 to 213466, 213473 to 213475, 213481, 213483, 213485 to 213488, 213511, 213673 and two 213484	15 75
213711	11701	Feed and Needle Carrying Frame Bushing	10
213639	11078	Feed and Needle Carrying Frame Collar with 200380c	15
200380c	12319	Feed and Needle Carrying Frame Collar Set Screw	02
213461	11067	Feed and Needle Carrying Frame Link	75
213494	11067	Feed Regulating Lever	60
213507	11073	" " " Connection	20
213506	11073	" " " " Pin (2)	05
213702	11073	Feed Regulating Lever Packing Washer	01
200095B	11067	Feed Regulating Lever Screw	04
213508	11078	" " " Segment, for forward feed	25
213509	11078	Feed Regulating Lever Segment, for reverse feed	30
201183D	11063	Feed Regulating Lever Segment Screw	04
200162D	11701	Feed Regulating Lever Segment Set Screw	04
201231c	11063	Feed Regulating Lever Segment Stop Screw	05
213503	11077	Feed Reversing Lever	40
200217H	11073	" " " Hinge Screw	15
213505	11073	" " " Spring	25
200781D	11073	" " " " Stop Screw	08
*221550	---	Hook (sewing)	—
221551	11703	" 221550 with 200088F, 213438 and 213644	5 00
221554	---	Hook and Bobbin Case complete, Nos. 213689 and 221551	6 00
213440	11064	Hook Bushing (lower)	25
213439	11064	" " (upper)	25
200378c	12311	" " Set Screw	02
213441	11064	" Driving Gear with two 200383c	1 00
200383c	12311	" " " Set Screw	02

No.	Plate	Name	Each
213493	11707	Hook Driving Shaft	\$1 00
213469	11702	" " " Bearing with 200027E	35
213470	11064	Hook Driving Shaft Bearing Bushing	25
200027E	11703	Hook Driving Shaft Bearing Bushing Clamp Screw	04
200019E	11064	Hook Driving Shaft Bearing Screw (2)	06
213443	11064	Hook Driving Shaft Bushing	25
200027E	11703	" " " " Clamp Screw	04
202574	11703	Hook Driving Shaft Collar with 200380c	15
200380c	12319	Hook Driving Shaft Collar Set Screw	02
221576	11069	Hook Driving Shaft Connection Belt Pulley with 202324 and two 201421c	75
201421c	11063	Hook Driving Shaft Connection Belt Pulley Set Screw	04
202324	11063	Hook Driving Shaft Connection Belt Pulley Spring Flange	08
221552	11703	Hook Gear with 200397c	1 00
221553	11703	" " Key	10
200397c	12349	" " Set Screw	02
*213438	---	" Gib	---
*213644	---	" " Hinge Pin	---
200088F	11064	" " Screw	02
213442	11069	" Saddle with 200027E and two 200378c	2 50
200019E	11064	Hook Saddle Screw (2)	06
202622	11703	" " " Washer (2)	01
221555	11704	Hook Saddle complete, Nos. 213439, 213440, 213442, 213446, 213447 and 221552 to 221554	11 00
202445	11707	Knee Lifter Connection Lever with 202446	07
221567	---	Knee Lifter Connection Lever 202445 with 200217H, 200224H, 213869 and 213870	60
200224H	11701	Knee Lifter Connection Lever Hinge Screw	12
213870	11707	Knee Lifter Connection Lever Lifting Rod with 202302	08
202302	11063	Knee Lifter Connection Lever Lifting Rod Cotter Pin	01
202446	11701	Knee Lifter Connection Lever Pin	03
213869	11707	" " Lifting Lever	20
213480	11185	Lifting Presser Bar with 200074F	85

No.	Plate	Name	Each
213481	11070	Lifting Presser Bar Collar with 200572F and two 200386c	\$1 00
200386c	11701	Lifting Presser Bar Collar Set Screw	02
200572F	11070	" " " " Slide Ad- justing Screw	04
200490B	11070	Lifting Presser Bar Sleeve Screw and Nut	35
213482	11070	Lifting Presser Bar Spring	10
200635B	11070	" " " " Follower Screw	25
200613F	11701	Lifting Presser Bar Spring Follower Screw Position Screw	03
214057	—	Lifting Presser Bar Vibrating Lever	1 10
213483	11070	" " " " " "	1 25
200230F	11070	Lifting Presser Bar Vibrating Lever Hinge Screw	10
201525E	11701	Lifting Presser Bar Vibrating Lever Hinge Screw Nut	03
213485	11071	Lifting Presser Bar Vibrating Lever Rocker Arm	1 00
213486	11071	Lifting Presser Bar Vibrating Lever Rocker Arm Link	75
213484	11071	Lifting Presser Bar Vibrating Lever Slide Block	25
229754	11079	Lifting Presser Foot	1 00
200074F	11701	" " " " Screw	03
213473	11185	Needle Bar (hollow) with 200125F	1 00
213474	11071	" " Collar with 200049F and 200572F	50
200049F	11071	Needle Bar Collar Set Screw	03
200572F	11070	" " " " Slide Adjusting Screw	04
213475	11071	Needle Bar Connecting Link	75
200125F	11701	" Set Screw	02
202554	11701	Presser Bar Lifter	25
200026D	11071	" " " Hinge Screw	04
213490	11071	" " " Shoe and Tension Release Stud	40
202068	12153	Spool Holder Base	15
200575H	12311	" " " Screw	05
204296	12153	" " Wire	10
200079H	12311	" " " Hinge Screw	02
204297	12153	Spool Holder complete, Nos. 200079H, 202068 and 204296	25
213673	11702	Take-up Cam with 200335c, 200383c and 200430c	2 25
200430c	12311	Take-up Cam Position Screw	08
200383c	12311	" " " " Check Screw	02

No.	Plate	Name	Each
200335c	12311	Take-up Cam Set Screw	\$ 04
213498	11705	" Lever	1 00
221572	—	" " 213498 with 213697	1 15
213697	11071	" " Bearing with 204264	15
204264	11705	" " " Position Pin	01
200042F	12311	" " " Screw	05
201816	11705	" " Roller	12
213499	11705	Take-up Lever complete, Nos. 200042F, 201816 and 221572	1 25
202402	12349	Tension Disc	05
202090	12349	" " Position Pin	01
213500	11072	" Release Lever	10
200309E	12349	" " " Screw	04
202075	12349	" " Plunger	03
202407	12349	" Spring	05
200632B	12349	" Stud	20
200397H	12349	" " Set Screw	02
201572B	12349	" Thumb Nut	04
204271	12349	" Washer	05
204272	12349	Tension complete, Nos. 200632B, 201572B, 202075, 202407, 204271 and two 202402	50
204274	12349	Thread Controller Plate	12
200577H	12311	" " " Screw	02
202098	12349	" " Roller	05
204275	12349	" " " Guard	10
202084	12349	" " " " Washer	01
200300c	12349	" " " Screw	04
204276	12349	" " Spring	03
204333	12349	" " " Guard	08
200581H	12349	" " " " Screw	02
202087	12349	" " " Stop	03
202088	12349	" " " Stud with 204925	10
200368H	12349	Thread Controller Spring Stud Set Screw	02
204925	11703	Thread Controller Spring Stud Washer	01
205987	12349	Thread Controller complete, Nos. 200300c, 200581H, 202084, 202098, 204274, 204275 and 204333	42
204280	12349	Thread Controller and Spring com- plete, Nos. 204276 and 205987	45
213448	11072	Thread Draw	15
213614	11072	" " Driving Fork Lever with 200389H	60
213501	11072	Thread Draw Driving Fork Lever Eccentric with 200366H	75
200366H	12349	Thread Draw Driving Fork Lever Eccentric Set Screw	02

No.	Plate	Name	Each
200389H	11701	Thread Draw Driving Fork Lever	
		Set Screw	\$ 02
213450	11072	Thread Draw Driving Shaft	15
213613	11071	" " " " Collar	
		with 200389H	10
200389H	11701	Thread Draw Driving Shaft Collar	
		Set Screw	02
213449	11073	Thread Draw Lever with two	
		each 200355H and 200397H	75
200355H	12319	Thread Draw Lever Adjusting	
		Screw	03
200397H	12349	Thread Draw Lever Set Screw	02
200397H	12349	" " Set Screw	02
202412	11703	" Guide	06
213489	11073	" "	10
200389C	11701	" " Set Screw	02
202482	12319	" Retainer Disc	02
213691	11072	" Guide Wire	05
200397H	12349	" " " " Set Screw	02
210993	11063	" " Sleeve	05
202483	12319	" " Spring (brass)	01
210992	11063	" " "	01
200631E	11072	" Stud	10
210957	11063	" " "	12
210958	11063	" " " Collar	08
201574D	11072	" " " Nut	03
200397H	12349	" " " Set Screw	02
213690	11072	Thread Retainer complete, Nos.	
		200631E, 201574D, 202483 and two	
		202482	20
212616	11074	Throat Plate, 50 needle hole, for	
		needle sizes 16 to 22	80
200577H	12311	Throat Plate Screw (2)	02
213487	11185	Vibrating Presser Bar with 200389C	60
213488	11073	" " " Collar with	
		200386C and 200572F	40
200386C	11701	Vibrating Presser Bar Collar Set	
		Screw	02
200572F	11070	Vibrating Presser Bar Collar Slide	
		Adjusting Screw	04
213484	11071	Vibrating Presser Bar Collar Slide	
		Block	25
213489	11073	Vibrating Presser Bar Thread Guide	10
200389C	11701	" " " " " "	
		Set Screw	02
229753	11079	Vibrating Presser Foot, 50 needle	
		hole, with 200941C	1 25
200941C	11701	Vibrating Presser Foot Pinch Screw	03

LIST OF PARTS COMPLETE

FOR

MACHINE No. 121w4

NEEDLE FEED. ALTERNATING PRESSERS.

For Carpets, Rugs, etc.

No.	Plate	Name	Each
*226826	---	Arm	\$ --
202247	11055	" Cap	35
200278H	12311	" " Screw	05
202248	11701	" " " Washer	05
204235	11701	" Position Pin (2)	02
200004E	11063	" Screw (3)	08
202005	11701	" " Washer (3)	01
213491	11183	" Shaft	1 75
202243	11055	" " Bushing (back) with	
		202244	75
202244	---	Arm Shaft Bushing (back) Oil	
		Packing (wick)	02
200338C	11701	Arm Shaft Bushing (back) Set	
		Screw	04
213452	11055	Arm Shaft Bushing (front) with	
		202260	35
202260	---	Arm Shaft Bushing (front) Oil	
		Packing (wick)	01
200352C	11701	Arm Shaft Bushing (front) Set	
		Screw	03
213453	11055	Arm Shaft Connection Belt	1 00
213454	11055	" " " " Pulley	
		with 200363C, 200396C and two	
		213455	1 25
200396C	11701	Arm Shaft Connection Belt Pulley	
		Position Screw	03
200363C	11701	Arm Shaft Connection Belt Pulley	
		Set Screw	03
213455	11063	Arm Shaft Connection Belt Pulley	
		Spring Flange	20
213492	11055	Arm Shaft Counter Balance with	
		200347C	25
200347C	11063	Arm Shaft Counter Balance Set	
		Screw	03
213471	11183	Balance Wheel (belt groove 2 3/4 in.	
		diam.) with two 200335C	1 00

No.	Plate	Name	Each
200062H	12311	Balance Wheel Adjusting Screw ..	\$ 07
200335C	12311	" " Set Screw	04
*226827	—	Bed	—
202258	12153	" Hinge Connection (2)	08
200570E	12311	" " " Screw (4)	05
213477	11055	" Slide (back) with 213478 and 213479	60
213476	11055	Bed Slide (front) with 213478 and 213479	60
213478	11063	Bed Slide Friction Slide	10
213479	11063	" " " Spring ..	02
213783	11064	Bobbin	08
*213444	—	" Case	—
203648	11703	" " Latch	10
*202056	11703	" " " Pin	—
213932	11703	" " " Plunger	10
203474	11703	" " " Spring	01
213446	11064	" " Lever	1 00
213447	11064	" " Arm with 200099H ..	30
200099H	11703	" " " Pinch Screw ..	02
213445	11064	" " Tension Spring	10
200984C	11703	" " " " Regulat- ing Screw	04
200594C	11703	Bobbin Case Tension Spring Screw ..	02
213689	11064	Bobbin Case complete, Nos. 200594C, 200984C, 202056, 203474, 203648, 213444, 213445 and 213932	1 00
226841	11711	Edge Guide	1 50
200077F	11710	" " Screw	03
226828	11707	Face Plate with 200368H, 200739F, 202087, 202090, 213691 and three 200397H	1 50
200053C	12311	Face Plate Screw (2)	04
200739F	11063	" " Thread Guide Screw ..	08
226829	11707	Face Plate complete, Nos. 200577H, 202088, 204272, 204280, 213500, 213690, 226828 and two 200309E ..	3 00
213464	11063	Feed Cam	75
213692	11066	" " Position Pin (2)	02
201827	11063	" " Roller	12
201821	—	" " " 201827 with 200818C ..	30
200818C	11066	" " " Screw Stud	15
201522E	11701	" " " " " Nut ..	03
200035E	11066	" " Screw	05
213465	11066	" Connection	40
213466	11066	" Link	50
213467	11066	" " Lever	50
200101D	11066	" " Stop Screw	04
213463	11066	" Eccentric Connection with 200094F	1 00

No.	Plate	Name	Each
200094F	11701	Feed Eccentric Connection Pinch Screw	\$ 02
213460	11702	Feed and Needle Carrying Frame with 213711	1 50
221569	—	Feed and Needle Carrying Frame 213460 with 200101D, 201522E, 201821, 213461, 213463 to 213467, 213473 to 213475, 213481, 213483, 213485 to 213488, 213673 and two 213484	15 75
213711	11701	Feed and Needle Carrying Frame Bushing	10
213639	11078	Feed and Needle Carrying Frame Collar with 200380C	15
200380C	12319	Feed and Needle Carrying Frame Collar Set Screw	02
213461	11067	Feed and Needle Carrying Frame Link	75
213494	11067	Feed Regulating Lever	60
213696	11067	" " " Friction Washer	10
200095B	11067	Feed Regulating Lever Screw	04
213496	11067	" " " Segment ..	25
201183D	11063	" " " " Screw ..	04
200681C	11067	" " " " Stop Screw	04
*221550	—	Hook (sewing)	—
221551	11703	" 221550 with 200088F, 213438 and 213644	5 00
221554	—	Hook and Bobbin Case complete, Nos. 213689 and 221551	6 00
213440	11064	Hook Bushing (lower)	25
213439	11064	" " (upper)	25
200378C	12311	" " Set Screw	02
213441	11064	" Driving Gear with two 200383C ..	1 00
200383C	12311	" " " Set Screw	02
213493	11707	" " Shaft	1 00
213469	11702	" " " Bearing with 200027E	35
213470	11064	Hook Driving Shaft Bearing Bush- ing	25
200027E	11703	Hook Driving Shaft Bearing Bush- ing Clamp Screw	04
200019E	11064	Hook Driving Shaft Bearing Screw (2)	06
213443	11064	Hook Driving Shaft Bushing	25
200027E	11703	" " " " Clamp Screw	04
202574	11703	Hook Driving Shaft Collar with 200380C	15

No.	Plate	Name	Each
213473	11185	Needle Bar (hollow) with 200125F	\$1 00
213474	11071	" " Collar with 200049F and 200572F	50
200049F	11071	Needle Bar Collar Set Screw	03
200572F	11070	" " Slide Adjusting Screw	04
213475	11071	Needle Bar Connecting Link	75
200125F	11701	" Set Screw	02
202554	11701	Presser Bar Lifter	25
200026D	11071	" " " Hinge Screw ...	04
213490	11071	" " " Shoe and Tension Release Stud	40
202068	12153	Spool Holder Base	15
200575H	12311	" " " Screw	05
204296	12153	" " Wire	10
200079H	12311	" " " Hinge Screw	02
204297	12153	Spool Holder complete, Nos. 200079H, 202068 and 204296	25
213673	11702	Take-up Cam with 200335c, 200383c and 200430c	2 25
200430c	12311	Take-up Cam Position Screw	08
200383c	12311	" " " " Check Screw	02
200335c	12311	Take-up Cam Set Screw	04
213498	11705	" Lever	1 00
221572	—	" " 213498 with 213697 ..	1 15
213697	11071	" " Bearing with 204264..	15
204264	11705	" " " Position Pin ..	01
200042F	12311	" " " Screw	05
201816	11705	" " Roller	12
213499	11705	Take-up Lever complete, Nos. 200042F, 201816 and 221572	1 25
202402	12349	Tension Disc	05
202090	12349	" " Position Pin	01
213500	11072	" Release Lever	10
200309E	12349	" " " Screw	04
202075	12349	" " Plunger	03
202407	12349	" Spring	05
200632B	12349	" Stud	20
200397H	12349	" " Set Screw	02
201572B	12349	" Thumb Nut	04
204271	12349	" Washer	05
204272	12349	Tension complete, Nos. 200632B, 201572B, 202075, 202407, 204271 and two 202402	50
204274	12349	Thread Controller Plate	12
200577H	12311	" " " Screw	02
202098	12349	" " Roller	05
204275	12349	" " " Guard	10
202084	12349	" " " " Washer	01

No.	Plate	Name	Each
200300C	12349	Thread Controller Roller Screw ..	\$ 04
204276	12349	" " Spring	03
204333	12349	" " " Guard	08
200581H	12349	" " " " Screw	02
202087	12349	" " " Stop	03
202088	12349	" " " Stud with 204925	10
200368H	12349	Thread Controller Spring Stud Set Screw	02
204925	11703	Thread Controller Spring Stud Washer	01
205987	12349	Thread Controller complete, Nos. 200300c, 200581H, 202084, 202098, 204274, 204275 and 204333	42
204280	12349	Thread Controller and Spring complete, Nos. 204276 and 205987 ...	45
213448	11072	Thread Draw	15
213614	11072	" " Driving Fork Lever with 200389H	60
213501	11072	Thread Draw Driving Fork Lever Eccentric with 200356H	75
200366H	12349	Thread Draw Driving Fork Lever Eccentric Set Screw	02
200389H	11701	Thread Draw Driving Fork Lever Set Screw	02
213450	11072	Thread Draw Driving Shaft	15
213613	11071	" " " " Collar with 200389H	10
200389H	11701	Thread Draw Driving Shaft Collar Set Screw	02
213449	11073	Thread Draw Lever with two each 200355H and 200397H	75
200355H	12319	Thread Draw Lever Adjusting Screw	03
200397H	12349	Thread Draw Lever Set Screw	02
200397H	12349	" " Set Screw	02
202412	11703	" Guide	06
213489	11703	" "	10
200389c	11701	" " Set Screw	02
202482	12319	" Retainer Disc	02
213691	11072	" " Guide Wire	05
200397H	12349	" " " " Set Screw	02
202483	12319	" " Spring (brass)	01
200631E	11072	" " Stud	10
201574D	11072	" " " Nut	03
200397H	12349	" " " Set Screw	02
213690	11072	Thread Retainer complete, Nos. 200631E, 201574D, 202483 and two 202482	20

No.	Plate	Name	Each
212841	11074	Throat Plate, 53 needle hole, for needle sizes 10 to 20	\$ 80
200577H	12311	Throat Plate Screw (2)	02
213487	11185	Vibrating Presser Bar with 200389c	60
213488	11073	" " " Collar with 200386c and 200572F	40
200386c	11701	Vibrating Presser Bar Collar Set Screw	02
200572F	11070	Vibrating Presser Bar Collar Slide Adjusting Screw	04
213484	11071	Vibrating Presser Bar Collar Slide Block	25
213489	11073	Vibrating Presser Bar Thread Guide	10
200389c	11701	" " " " " Set Screw	02
226853	11706	Vibrating Presser Foot with 200941c	1 25
200941c	11701	" " " Pinch Screw	03

LIST OF PARTS COMPLETE

FOR

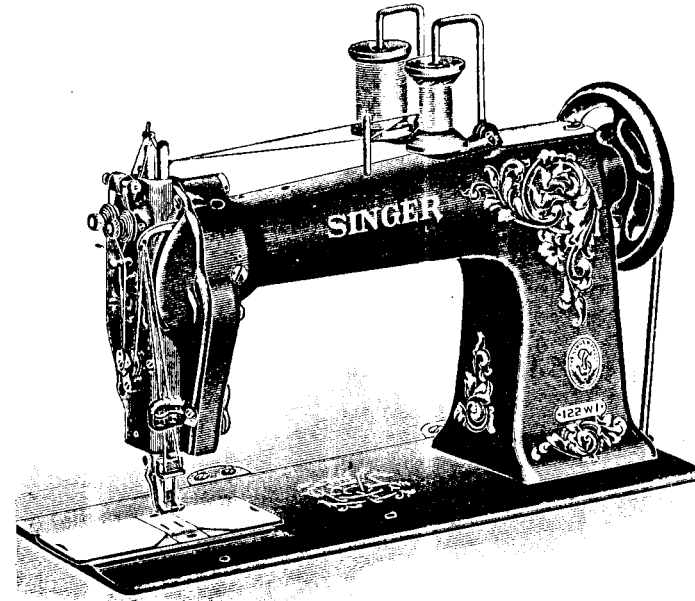

MACHINE No. 122w1

NEEDLE FEED. ALTERNATING PRESSERS.

For Sewing Rough, Uneven or Sticky Goods.

In gauges from $\frac{1}{8}$ to 1 inch.

No.	Plate	Name	Each
*213451	---	Arm	\$ ---
202247	11055	" Cap	35
200278H	12311	" " Screw	05
202248	11701	" " " Washer	05
204235	11701	" Position Pin (2)	02
200004E	11063	" Screw (3)	08
202005	11701	" " Washer (3)	01
213491	11183	" Shaft	1 75
202243	11055	" " Bushing (back) with 202244	75

LIST OF PARTS COMPLETE

FOR

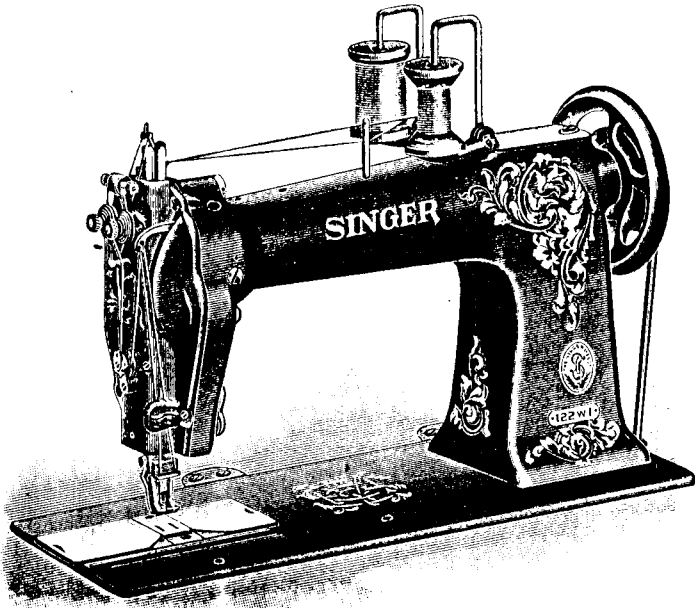

MACHINE No. 122w1

NEEDLE FEED. ALTERNATING PRESSERS.

For Sewing Rough, Uneven or Sticky Goods.

In gauges from $\frac{1}{8}$ to 1 inch.

No.	Plate	Name	Each
*213451	—	Arm	\$ —
202247	11055	“ Cap	35
200278H	12311	“ “ Screw	05
202248	11701	“ “ “ Washer	05
204235	11701	“ Position Pin (2)	02
200004E	11063	“ Screw (3)	08
202005	11701	“ “ Washer (3)	01
213491	11183	“ Shaft	1 75
202243	11055	“ “ Bushing (back) with 202244	75

No.	Plate	Name	Each
200594c	11703	Bobbin Case Tension Spring Screw	\$ 02
213689	11064	Bobbin Case (left) complete, Nos. 200594c, 200984c, 202056, 203474, 203648, 213444, 213445 and 213932	1 00
213703	11078	Bobbin Case (right) complete, Nos. 200594c, 200984c, 202056, 203474, 203648, 213445, 213615 and 213932	1 00
213519	11707	Face Plate with 200739F, 202087, 213502, 213517, 221546, two each 200368H, 202099 and four 200397H	1 75
200053c	12311	Face Plate Screw (2)	04
213502	11063	“ “ Thread Guide	10
200739F	11063	“ “ “ “ Screw ..	08
200397H	12349	“ “ “ “ Set Screw	02
221546	—	“ “ “ Oiling Felt	01
213520	11707	Face Plate complete, Nos. 200577H, 202088, 204280, 213515, 213519, 213704, two each 200309E and 204272	3 90
213464	11063	Feed Cam	75
213692	11066	“ “ Position Pin (2)	02
201827	11063	“ “ Roller	12
201821	—	“ “ “ 201827 with 200818c	30
200818c	11066	“ “ “ Screw Stud	15
201522E	11701	“ “ “ “ “ Nut ..	03
200035E	11066	“ “ Screw	05
213465	11066	“ Connection	40
213466	11066	“ “ Link	50
213467	11066	“ “ “ Lever	50
200101D	11066	“ “ Stop Screw	04
213463	11066	“ Eccentric Connection with 200094F	1 00
200094F	11701	Feed Eccentric Connection Pinch Screw	02
213460	11702	Feed and Needle Carrying Frame with 213711	1 50
221566	—	Feed and Needle Carrying Frame 213460 with 200101D, 201522E, 201821, 213461, 213463 to 213467, 213474, 213475, 213481, 213483, 213485, 213486, 213488, 213513, 213514, 221564 and two 213484 ...	16 00
213711	11701	Feed and Needle Carrying Frame Bushing	10
213639	11078	Feed and Needle Carrying Frame Collar with 200380c	15
200380c	12319	Feed and Needle Carrying Frame Collar Set Screw	02
213461	11067	Feed and Needle Carrying Frame Link	75

40

Parts for Machine No. 122w1

No.	Plate	Name	Each	No.	Plate	Name	Each
213494	11067	Feed Regulating Lever	\$ 60	213442	11069	Hook Saddle (left) with 200027E and two 200378c	\$2 50
213696	11067	" " " Friction Washer	10	213616	11069	Hook Saddle (right) with 200027E and two 200378c	2 50
200095B	11067	Feed Regulating Lever Screw	04	200019E	11064	Hook Saddle Screw (4)	06
213496	11067	" " " Segment ...	25	202622	11703	" " " Washer (4) ...	01
201183D	11063	" " " " Screw	04	221555	11704	Hook Saddle (left) complete, Nos. 213439, 213440, 213442, 213446, 213447 and 221552 to 221554	11 00
200681C	11067	" " " " Stop Screw	04	221556	11704	Hook Saddle (right) complete, Nos. 213439, 213440, 213446, 213447, 213616, 221552, 221553 and 221558	11 00
*221550	—	Hook (sewing)	—	221557	—	Hook Saddle Combination (left and right) complete, Nos. 221555 and 221556	22 00
221551	11703	" 221550 with 200088E, 213438 and 213644	5 00	202445	11707	Knee Lifter Connection Lever with 202446	07
221554	—	Hook and Bobbin Case (left) com- plete, Nos. 213689 and 221551 ..	6 00	213871	—	Knee Lifter Connection Lever 202445 with 200224u, 200262u, 213869 and 213870	55
221558	—	Hook and Bobbin Case (right) com- plete, Nos. 213703 and 221551 ..	6 00	200224u	11701	Knee Lifter Connection Lever Hinge Screw	12
213440	11064	Hook Bushing (lower)	25	213870	11707	Knee Lifter Connection Lever Lift- ing Rod with 202302	08
213439	11064	" " (upper)	25	202302	11063	Knee Lifter Connection Lever Lift- ing Rod Cotter Pin	01
200378c	12311	" " Set Screw	02	202446	11701	Knee Lifter Connection Lever Pin	03
213441	11064	" Driving Gear with two 200383c (2)	1 00	213869	11707	" " Lifting Lever	20
200383c	12311	Hook Driving Gear Set Screw	02	200262u	11701	" " " " Hinge Screw	10
213493	11707	" " Shaft	1 00	213480	11185	Lifting Presser Bar with 200074F ..	85
213469	11702	" " " Bearing with 200027E	35	213481	11070	" " " Collar with 200572E and two 200386c	1 00
213470	11064	Hook Driving Shaft Bearing Bush- ing	25	200386c	11701	Lifting Presser Bar Collar Set Screw	02
200027E	11703	Hook Driving Shaft Bearing Bush- ing Clamp Screw	04	200572E	11070	" " " " Slide Ad- justing Screw	04
200019E	11064	Hook Driving Shaft Bearing Screw (2)	06	200490B	11070	Lifting Presser Bar Sleeve Screw and Nut	35
213443	11064	Hook Driving Shaft Bushing (2) ..	25	213482	11070	Lifting Presser Bar Spring	10
200027E	11703	" " " " Clamp Screw	04	200635B	11070	" " " " Follower Screw	25
202574	11703	Hook Driving Shaft Collar with 200380c	15	200613F	11701	Lifting Presser Bar Spring Follower Screw Position Screw	03
200380c	12319	Hook Driving Shaft Collar Set Screw	02	214057	—	Lifting Presser Bar Vibrating Lever	1 10
221576	11069	Hook Driving Shaft Connection Belt Pulley with 202324 and two 201421c	75	213483	11070	" " " " " 214057 with 200230E and 201525E	1 25
201421c	11063	Hook Driving Shaft Connection Belt Pulley Set Screw	04	200230E	11070	Lifting Presser Bar Vibrating Lever Hinge Screw	10
202324	11063	Hook Driving Shaft Connection Belt Pulley Spring Flange	08	201525E	11701	Lifting Presser Bar Vibrating Lever Hinge Screw Nut	03
221552	11703	Hook Gear with 200397c	1 00				
221553	11703	" " Key	10				
200397c	12349	" " Set Screw	02				
*213438	—	" Gib	—				
*213644	—	" " Hinge Pin	—				
200088F	11064	" " Screw	02				

No.	Plate	Name	Each
213485	11071	Lifting Presser Bar Vibrating Lever Rocker Arm	\$1 00
213486	11071	Lifting Presser Bar Vibrating Lever Rocker Arm Link	75
213484	11071	Lifting Presser Bar Vibrating Lever Slide Block	25
229833	11706	Lifting Presser Foot, for 229834, in gauges $\frac{1}{8}$, $\frac{3}{16}$, $\frac{1}{4}$ and $\frac{5}{16}$ inch ...	1 00
229756	11080	Lifting Presser Foot, for 229757, in gauges from $\frac{1}{4}$ to $\frac{1}{2}$ in., in steps of $\frac{1}{16}$ inch	1 25
229825	11706	Lifting Presser Foot, for 229758, in gauges from $\frac{1}{4}$ to 1 in., in steps of $\frac{1}{16}$ inch	1 25
200074F	11701	Lifting Presser Foot Screw	03
213514	11702	Needle Bar (hollow)	1 00
213474	11071	" " Collar with 200049F and 200572F	50
200049F	11071	Needle Bar Collar Set Screw	03
200572F	11070	" " " Slide Adjusting Screw	04
213475	11071	Needle Bar Connecting Link	75
203712	11701	" Holder, in gauges from $\frac{1}{4}$ to 1 in., in steps of $\frac{1}{16}$ in., with two each 200389c and 200581H	1 50
200581H	12349	Needle Holder Screw	02
200389c	11701	" Set Screw	02
202554	11701	Presser Bar Lifter	25
200026D	11071	" " " Hinge Screw ...	04
213490	11071	" " " Shoe and Tension Release Stud	40
202068	12153	Spool Holder Base	15
204551	11702	" " " Bracket	15
200257D	11701	" " " " Screw ..	08
204552	11702	Spool Holder Base Bracket com- plete, Nos. 204551, two each 200575H and 204297	75
200575H	12311	Spool Holder Base Screw	05
204296	12153	" " Wire	10
200079H	12311	" " " Hinge Screw ...	02
204297	12153	Spool Holder complete, Nos. 200079H, 202068 and 204296	25
221564	11185	Take-up Cam with 200335c, 200383c and 200430c	2 50
200430c	12311	Take-up Cam Position Screw	08
200383c	12311	" " " " Check Screw	02
200335c	12311	Take-up Cam Set Screw	04
213705	11705	" Lever	1 15
221573	—	" " 213705 with 213697..	1 30

No.	Plate	Name	Each
213697	11071	Take-up Lever Bearing with 204264	\$ 15
204264	11705	" " " Position Pin	01
200042F	12311	" " " Screw	05
201816	11705	" " Roller	12
213516	11705	Take-up Lever complete, Nos. 200042F, 201816 and 221573	1 40
202402	12349	Tension Disc	05
202090	12349	" " Position Pin	01
213515	11078	" Release Lever	15
200309E	12349	" " " Screw	04
202075	12349	" " Plunger	03
202407	12349	" Spring	05
200632B	12349	" Stud	20
200397H	12349	" " Set Screw	02
201572B	12349	" Thumb Nut	04
204271	12349	" Washer	05
204272	12349	Tension complete, Nos. 200632B, 201572B, 202075, 202407, 204271 and two 202402	50
204274	12349	Thread Controller Plate	12
200577H	12311	" " " Screw	02
202098	12349	" " Roller	05
204275	12349	" " " Guard	10
202084	12349	" " " " Washer	01
200300c	12349	" " " Screw	04
204276	12349	" " Spring	03
204333	12349	" " " Guard	08
200581H	12349	" " " " Screw	02
202087	12349	" " " Stop	03
202088	12349	" " " Stud with 204925	10
200368H	12349	Thread Controller Spring Stud Set Screw	02
204925	11703	Thread Controller Spring Stud Washer,	01
205987	12349	Thread Controller complete, Nos. 200300c, 200581H, 202084, 202098, 204274, 204275 and 204333	42
204280	12349	Thread Controller and Spring com- plete, Nos. 204276 and 205987	45
213448	11072	Thread Draw (left)	15
213617	11078	" " (right)	25
213619	11078	" " Driving Fork Lever with 200389H, for gauges from $\frac{1}{4}$ to $\frac{1}{16}$ inch	75
221548	11703	Thread Draw Driving Fork Lever with 200389H, for gauges from $\frac{1}{4}$ to $\frac{1}{8}$ inch	75

No.	Plate	Name	Each
213620	11703	Thread Draw Driving Fork Lever with 200389u, for gauges from $\frac{3}{16}$ to 1 inch	\$ 75
213501	11072	Thread Draw Driving Fork Lever Eccentric with 200366u	75
200366u	12349	Thread Draw Driving Fork Lever Eccentric Set Screw	02
200389u	11701	Thread Draw Driving Fork Lever Set Screw	02
213618	11078	Thread Draw Driving Shaft	20
213613	11071	" " " " Collar with 200389u (2)	10
200389u	11701	Thread Draw Driving Shaft Collar Set Screw	02
213449	11073	Thread Draw Lever with two each 200355u and 200397u (2)	75
200355u	12319	Thread Draw Lever Adjusting Screw	03
200397u	12349	Thread Draw Lever Set Screw	02
200397u	12349	" " Set Screw	02
203313	11703	" Guide	10
213489	11073	" " (left)	10
213706	11073	" " (right)	10
200389c	11701	" " Set Screw	02
202482	12319	" Retainer Disc	02
213517	11703	" " Guide Wire	02
200397u	12349	" " " " Set Screw	02
202483	12319	" " Spring (brass)	01
200624E	11703	" " Stud	12
201574D	11072	" " " Nut	03
200368u	12349	" " " Set Screw	02
213704	11703	Thread Retainer complete, Nos. 200624E, two each 201574D, 202483 and four 202482	25
212846	11074	Throat Plate, 50 needle hole, for needle sizes 16 to 22, in gauges from $\frac{1}{4}$ to 1 in., in steps of $\frac{1}{32}$ inch	1 50
200577u	12311	Throat Plate Screw (2)	02
213513	11702	Vibrating Presser Bar with 200389c	75
213488	11073	" " " Collar with 200386c and 200572F	40
200386c	11701	Vibrating Presser Bar Collar Set Screw	02
200572F	11070	Vibrating Presser Bar Collar Slide Adjusting Screw	04
213484	11071	Vibrating Presser Bar Collar Slide Block	25
213489	11073	Vibrating Presser Bar Thread Guide (left)	10

No.	Plate	Name	Each
213706	11073	Vibrating Presser Bar Thread Guide (right)	\$ 10
200389c	11701	Vibrating Presser Bar Thread Guide Set Screw	02
229834	11706	Vibrating Presser Foot, 50 needle hole, in gauges $\frac{1}{4}$, $\frac{3}{16}$, $\frac{1}{2}$ and $\frac{3}{4}$ in., with 200941c, for 229833	1 50
229757	11080	Vibrating Presser Foot, 50 needle hole, in gauges from $\frac{1}{4}$ to $\frac{1}{2}$ in., in steps of $\frac{1}{32}$ in., with 200941c, for 229756	1 80
229758	11080	Vibrating Presser Foot, 50 needle hole, in gauges from $\frac{1}{4}$ to 1 in., in steps of $\frac{1}{32}$ in., with 200941c, for 229825	2 00
200941c	11701	Vibrating Presser Foot Pinch Screw	03

LIST OF PARTS COMPLETE
FOR
MACHINE No. 122w2

NEEDLE FEED. ALTERNATING PRESSERS.

For Heavy Lap Seam Felling.

In gauges from $\frac{1}{8}$ to 1 inch.

No.	Plate	Name	Each
*213451	—	Arm	\$ —
202247	11055	" Cap	35
200278n	12311	" " Screw	05
202248	11701	" " " Washer	05
204235	11701	" Position Pin (2)	02
200004E	11063	" Screw (3)	08
202005	11701	" " Washer (3)	01
213491	11183	" Shaft	1 75
202243	11055	" " Bushing (back) with 202244	75
202244	—	Arm Shaft Bushing (back) Oil Packing (wick)	02
200338c	11701	Arm Shaft Bushing (back) Set Screw	04
213452	11055	Arm Shaft Bushing (front) with 202260	35
202260	—	Arm Shaft Bushing (front) Oil Packing (wick)	01
200352c	11701	Arm Shaft Bushing (front) Set Screw	03
*213453	11055	Arm Shaft Connection Belt	1 00
213454	11055	" " " " Pulley with 200363c, 200396c and two 213455	1 25
200396c	11701	Arm Shaft Connection Belt Pulley Position Screw	03
200363c	11701	Arm Shaft Connection Belt Pulley Set Screw	03
213455	11063	Arm Shaft Connection Belt Pulley Spring Flange	20
213492	11055	Arm Shaft Counter Balance with 200347c	25
200347c	11063	Arm Shaft Counter Balance Set Screw	03
213471	11183	Balance Wheel (belt groove $2\frac{3}{4}$ in. diam.) with two 200335c	\$1 00
200062H	12311	Balance Wheel Adjusting Screw	07
200335c	12311	" " Set Screw	04
*213512	—	Bed	—
202258	12153	" Hinge Connection (2)	08
200570E	12311	" " " Screw (4)	05
213522	11069	" Slide (back) with 213478 and 213479	60
213521	11069	Bed Slide (front) with 213478 and 213479	60
213478	11063	Bed Slide Friction Slide	10
213479	11063	" " " " Spring	02
213783	11064	Bobbin	08
*213444	—	" Case (left)	—
*213615	—	" " (right)	—
203648	11703	" " Latch	10
*202056	11703	" " " Pin	—
213932	11703	" " " Plunger	10
203474	11703	" " " Spring	01
213446	11064	" " Lever	1 00
213447	11064	" " " Arm with 200099H	30
200099H	11703	" " " Pinch Screw	02
213445	11064	" " Tension Spring	10
200984c	11703	" " " " Regulat- ing Screw	04
200594c	11703	Bobbin Case Tension Spring Screw	02
213689	11064	Bobbin Case (left) complete, Nos. 200594c, 200984c, 202056, 203474, 203648, 213444, 213445 and 213932	1 00
213703	11078	Bobbin Case (right) complete, Nos. 200594c, 200984c, 202056, 203474, 203648, 213445, 213615 and 213932	1 00
213519	11707	Face Plate with 200739F, 202087, 213502, 213517, 221546, two each 200368H, 202090 and four 200397H	1 75
200053c	12311	Face Plate Screw (2)	04
213502	11063	" " Thread Guide	10
200739F	11063	" " " " Screw	08
200397H	12349	" " " " Set Screw	02
221546	—	" " " Oiling Felt	01
213520	11707	Face Plate complete, Nos. 200577H, 202088, 204280, 213515, 213519, 213704, two each 200309E and 204272	3 90
213464	11063	Feed Cam	75
213692	11066	" " Position Pin (2)	02
201827	11063	" " Roller	12
201821	—	" " " 201827 with 200818c	30
200818c	11066	" " " Screw Stud	15

No.	Plate	Name	Each
201522E	11701	Feed Cam Roller Screw Stud Nut	\$ 03
200035E	11066	" " Screw	05
213465	11066	" Connection	40
213466	11066	" " Link	50
213467	11066	" " " Lever	50
200101D	11066	" " Stop Screw	04
213463	11066	" Eccentric Connection with 200094F	1 00
200094F	11701	Feed Eccentric Connection Pinch Screw	02
213460	11702	Feed and Needle Carrying Frame with 213711	1 50
221566	—	Feed and Needle Carrying Frame 213460 with 200101D, 201522E, 201821, 213461, 213463 to 213467, 213474, 213475, 213481, 213483, 213485, 213486, 213488, 213513, 213514, 221564 and two 213484	16 00
213711	11701	Feed and Needle Carrying Frame Bushing	10
213639	11078	Feed and Needle Carrying Frame Collar with 200380c	15
200380c	12319	Feed and Needle Carrying Frame Collar Set Screw	02
213461	11067	Feed and Needle Carrying Frame Link	75
213494	11067	Feed Regulating Lever	60
213696	11067	" " " Friction Washer	10
200095B	11067	Feed Regulating Lever Screw	04
213496	11067	" " " Segment	25
201183D	11063	" " " " Screw	04
200681c	11067	" " " " Stop Screw	04
*221550	—	Hook (sewing)	—
221551	11703	" 221550 with 200088F, 213438 and 213644	5 00
221554 221587		Hook and Bobbin Case (left) com- plete, Nos. 213689 and 221551	6 00
221558 221612		Hook and Bobbin Case (right) com- plete, Nos. 213703 and 221551	6 00
213440	11064	Hook Bushing (lower)	25
213439	11064	" " (upper)	25
200378c	12311	" " Set Screw	02
213441	11064	" Driving Gear with two 200383c (2)	1 00
200383c	12311	Hook Driving Gear Set Screw	02
213493	11707	" " Shaft	1 00
213469	11702	" " " Bearing with 200027E	35

No.	Plate	Name	Each
213470	11064	Hook Driving Shaft Bearing Bush- ing	\$ 25
200027E	11703	Hook Driving Shaft Bearing Bush- ing Clamp Screw	04
200019E	11064	Hook Driving Shaft Bearing Screw (2)	06
213443	11064	Hook Driving Shaft Bushing (2)	25
200027E	11703	" " " " Clamp Screw	04
202574	11703	Hook Driving Shaft Collar with 200380c	15
200380c	12319	Hook Driving Shaft Collar Set Screw	02
221576	11069	Hook Driving Shaft Connection Belt Pulley with 202324 and two 201421c	75
201421c	11063	Hook Driving Shaft Connection Belt Pulley Set Screw	04
202324	11063	Hook Driving Shaft Connection Belt Pulley Spring Flange	08
221552	11703	Hook Gear with 200397c	1 00
221553	11703	" " Key	10
200397c	12349	" " Set Screw	02
*213438	—	" Gib	—
*213644	—	" " Hinge Pin	—
200088F	11064	" " Screw	02
213442	11069	" Saddle (left) with 200027E and two 200378c	2 50
213616	11069	Hook Saddle (right) with 200027E and two 200378c	2 50
200019E	11064	Hook Saddle Screw (4)	06
202622	11703	" " " Washer (4)	01
221555	11704	Hook Saddle (left) complete, Nos. 213439, 213440, 213442, 213446, 213447 and 221552 to 221554	11 00
221556	11704	Hook Saddle (right) complete, Nos. 213439, 213440, 213446, 213447, 213616, 221552, 221553 and 221558	11 00
221557	—	Hook Saddle Combination (left and right) complete, Nos. 221555 and 221556	22 00
202445	11707	Knee Lifter Connection Lever with 202446	07
213871	—	Knee Lifter Connection Lever 202445 with 200224H, 200262H, 213869 and 213870	55
200224H	11701	Knee Lifter Connection Lever Hinge Screw	12
213870	11707	Knee Lifter Connection Lever Lift- ing Rod with 202302	08

No.	Plate	Name	Each
202302	11063	Knee Lifter Connection Lever Lifting Rod Cotter Pin	\$ 01
202446	11701	Knee Lifter Connection Lever Pin	03
213869	11707	" " Lifting Lever	20
200262H	11701	" " " " Hinge Screw	10
213480	11185	Lifting Presser Bar with 200074F ..	85
213481	11070	" " " Collar with 200572F and two 200386c	1 00
200386c	11701	Lifting Presser Bar Collar Set Screw	02
200572F	11070	Lifting Presser Bar Collar Slide Adjusting Screw	04
200490B	11070	Lifting Presser Bar Sleeve Screw and Nut	35
213482	11070	Lifting Presser Bar Spring	10
200635B	11070	" " " " Follower Screw	25
200613F	11701	Lifting Presser Bar Spring Follower Screw Position Screw	03
214057	—	Lifting Presser Bar Vibrating Lever	1 10
213483	11070	" " " " " " 214057 with 200230F and 201525E	1 25
200230F	11070	Lifting Presser Bar Vibrating Lever Hinge Screw	10
201525E	11701	Lifting Presser Bar Vibrating Lever Hinge Screw Nut	03
213485	11071	Lifting Presser Bar Vibrating Lever Rocker Arm	1 00
213486	11071	Lifting Presser Bar Vibrating Lever Rocker Arm Link	75
213484	11071	Lifting Presser Bar Vibrating Lever Slide Block	25
229833	11706	Lifting Presser Foot, for 229834, in gauges $\frac{1}{4}$, $\frac{3}{8}$, $\frac{1}{2}$ and $\frac{3}{4}$ inch	1 00
229756	11080	Lifting Presser Foot, for 229757, in gauges from $\frac{1}{4}$ to $\frac{1}{2}$ in., in steps of $\frac{1}{32}$ inch	1 25
229825	11706	Lifting Presser Foot, for 229758, in gauges from $\frac{1}{4}$ to 1 in., in steps of $\frac{1}{32}$ inch	1 25
200074F	11701	Lifting Presser Foot Screw	03
213514	11702	Needle Bar (hollow)	1 00
213474	11071	" " Collar with 200049F and 200572F	50
200049F	11071	Needle Bar Collar Set Screw	03
200572F	11070	" " " Slide Adjusting Screw	04
213475	11071	Needle Bar Connecting Link	75

No.	Plate	Name	Each
203712	11701	Needle Holder, in gauges from $\frac{1}{4}$ to 1 in., in steps of $\frac{1}{32}$ in., with two each 200389c and 200581H	\$1 50
200581H	12349	Needle Holder Screw	02
200389c	11701	" Set Screw	02
202554	11701	Presser Bar Lifter	25
200026D	11071	" " " Hinge Screw	04
213490	11071	" " " Shoe and Tension Release Stud	40
202068	12153	Spool Holder Base	15
204551	11702	" " " Bracket	15
200257D	11701	" " " " Screw	08
204552	11702	Spool Holder Base Bracket complete, Nos. 204551, two each 200575H and 204297	75
200575H	12311	Spool Holder Base Screw	05
204296	12153	" " Wire	10
200079H	12311	" " " Hinge Screw	02
204297	12153	Spool Holder complete, Nos. 200079H, 202068 and 204296	25
221564	11185	Take-up Cam with 200335c, 200383c and 200430c	2 50
200430c	12311	Take-up Cam Position Screw	08
200383c	12311	" " " " Check Screw	02
200335c	12311	Take-up Cam Set Screw	04
213705	11705	" Lever	1 15
221573	—	" " 213705 with 213697 ..	1 30
213697	11071	" " Bearing with 204264 ..	15
204264	11705	" " " Position Pin ..	01
200042F	12311	" " " Screw	05
201816	11705	" " Roller	12
213516	11705	Take-up Lever complete, Nos. 200042F, 201816 and 221573	1 40
202402	12349	Tension Disc	05
202090	12349	" " Position Pin	01
213515	11078	" Release Lever	15
200309E	12349	" " " Screw	04
202075	12349	" " Plunger	03
202407	12349	" Spring	05
200632B	12349	" Stud	20
200397H	12349	" " Set Screw	02
201572B	12349	" Thumb Nut	04
204271	12349	" Washer	05
204272	12349	Tension complete, Nos. 200632B, 201572B, 202075, 202407, 204271 and two 202402	50
204274	12349	Thread Controller Plate	12

No.	Plate	Name	Each
200577H	12311	Thread Controller Plate Screw	\$ 02
202098	12349	" " Roller	05
204275	12349	" " " Guard	10
202084	12349	" " " " Washer	01
200300C	12349	" " " Screw	04
204276	12349	" " Spring	03
204333	12349	" " " Guard	08
200581H	12349	" " " Screw	02
202087	12349	" " " Stop	03
202088	12349	" " " Stud with 204925	10
200368H	12349	Thread Controller Spring Stud Set Screw	02
204925	11703	Thread Controller Spring Stud Washer	01
205987	12349	Thread Controller complete, Nos. 200300C, 200581H, 202084, 202098, 204274, 204275 and 204333	42
204280	12349	Thread Controller and Spring com- plete, Nos. 204276 and 205987	45
213448	11072	Thread Draw (left)	15
213617	11078	" " (right)	25
213619	11078	" " Driving Fork Lever with 200389H, for gauges from $\frac{1}{8}$ to $\frac{1}{4}$ inch	75
221548	11703	Thread Draw Driving Fork Lever with 200389H, for gauges from $\frac{1}{4}$ to $\frac{1}{2}$ inch	75
213620	11703	Thread Draw Driving Fork Lever with 200389H, for gauges from $\frac{3}{8}$ to 1 inch	75
213501	11072	Thread Draw Driving Fork Lever Eccentric with 200366H	75
200366H	12349	Thread Draw Driving Fork Lever Eccentric Set Screw	02
200389H	11701	Thread Draw Driving Fork Lever Set Screw	02
213618	11078	Thread Draw Driving Shaft	20
213613	11071	" " " " Collar with 200389H (2)	10
200389H	11701	Thread Draw Driving Shaft Collar Set Screw	02
213449	11073	Thread Draw Lever with two each 200355H and 200397H (2)	75
200355H	12319	Thread Draw Lever Adjusting Screw	03
200397H	12349	Thread Draw Lever Set Screw . . .	02
200397H	12349	" " Set Screw	02
203313	11703	" Guide	10
213489	11073	" " (left)	10

No.	Plate	Name	Each
213706	11073	Thread Guide (right)	\$ 10
200389C	11701	" " Set Screw	02
202482	12319	" Retainer Disc	02
213517	11703	" " Guide Wire	02
200397H	12349	" " " Set Screw	02
202483	12319	" " Spring (brass)	01
200624E	11703	" " Stud	12
201574D	11072	" " " Nut	03
200368H	12349	" " " Set Screw	02
213704	11703	Thread Retainer complete, Nos. 200624E, two each 201574D, 202483 and four 202482	25
212857	11074	Throat Plate, 50 needle hole, for needle sizes 16 to 22, in gauges from $\frac{1}{4}$ to 1 in., in steps of $\frac{1}{32}$ inch	1 50
200577H	12311	Throat Plate Screw (2)	02
213513	11702	Vibrating Presser Bar with 200389C	75
213488	11073	" " " Collar with 200386C and 200572F	40
200386C	11701	Vibrating Presser Bar Collar Set Screw	02
200572F	11070	Vibrating Presser Bar Collar Slide Adjusting Screw	04
213484	11071	Vibrating Presser Bar Collar Slide Block	25
213489	11073	Vibrating Presser Bar Thread Guide (left)	10
213706	11073	Vibrating Presser Bar Thread Guide (right)	10
200389C	11701	Vibrating Presser Bar Thread Guide Set Screw	02
229834	11706	Vibrating Presser Foot, 50 needle hole, in gauges $\frac{1}{8}$, $\frac{3}{16}$, $\frac{1}{4}$ and $\frac{5}{16}$ in., with 200941C, for 229833	1 50
229757	11080	Vibrating Presser Foot, 50 needle hole, in gauges from $\frac{1}{4}$ to $\frac{1}{2}$ in., in steps of $\frac{1}{32}$ in., with 200941C, for 229756	1 80
229758	11080	Vibrating Presser Foot, 50 needle hole, in gauges from $\frac{1}{4}$ to 1 in., in steps of $\frac{1}{32}$ in., with 200941C, for 229825	2 00
200941C	11701	Vibrating Presser Foot Pinch Screw	03

ACCESSORIES

FOR MACHINES NOS. 121W1 AND 121W4

No.	Plate	Name	Each
213783	11064	Bobbin (5)	\$ 08
*225482	—	" Case Screw Driver Blade..	—
*225483	—	" " " " Handle	—
225497	12153	Bobbin Case Screw Driver complete, Nos. 225482 and 225483 ...	10
19 n1	—	Needles, two each, sizes 16, 18 and 20	30
225181	—	Drip Pan (long) with four wood screws ½ in., No. 5	35
41400	12153	Machine Rest Pin (wood)	04
36578	12153	Oiler with 36579	10
36579	12153	" Spout, 3 in. long	06
*225484	—	Screw Driver Blade	—
*225485	—	" " Handle	—
225498	12153	Screw Driver complete (7½ in. long), Nos. 225484 and 225485 ...	15
225554	12153	Wrench (steel)	10

BOBBIN WINDER

Swing Automatic, Right Hand.

202470	12320	Bobbin Winder Base	15
202471	12320	" " Frame	15
200221D	12319	" " " Hinge Screw..	12
202472	12319	" " " Spring	05
200161D	12319	" " " " Screw..	04
202473	12320	" " Pulley with 200380c	20
200380c	12319	" " " Set Screw	02
202474	12320	" " Spindle	15
227522	12319	" " Stop Latch	10
200056E	12319	" " " " Screw..	03
202477	12319	" " " " Thumb Lever	15
200299H	12319	Bobbin Winder Stop Latch Thumb Lever Hinge Screw	05
200299H	12319	Bobbin Winder Stop Latch Thumb Lever Joint Screw	05
201537H	12319	Bobbin Winder Stop Latch Thumb Lever Joint Screw Nut	03
202478	12319	Bobbin Winder Stop Latch Trip Lever	10

No.	Plate	Name	Each
200299H	12319	Bobbin Winder Stop Latch Trip Lever Hinge Screw	\$ 05
227523	12320	Bobbin Winder complete, Nos. 200056E, 200161D, 200221D, 201537H, 202470 to 202474, 202477, 202478, 227522, three 200299H and two wood screws 1½ in., No. 14, R.H.B.	1 35
202480	12320	Bobbin Winder Spool Holder Base with 200355H and 202484	15
202481	12320	Bobbin Winder Spool Holder Base Spool Pin	05
202482	12319	Bobbin Winder Spool Holder Tension Disc (lower or upper)	02
200011E	12319	Bobbin Winder Spool Holder Tension Disc Screw	05
200355H	12319	Bobbin Winder Spool Holder Tension Disc Screw Set Screw	03
202483	12319	Bobbin Winder Spool Holder Tension Disc Spring (brass)	01
202484	12319	Bobbin Winder Spool Holder Tension Disc Thread Guide	01
202485	12320	Bobbin Winder Spool Holder complete, Nos. 200011E, 202480, 202481, 202483, two 202482 and one wood screw 1 in., No. 13	35
227524	—	Bobbin Winder and Spool Holder complete, Nos. 202485 and 227523	1 65

KNEE LIFTER

227781	11707	Knee Lifter Rock Lever with 200522c and 200529c	35
227782	—	Knee Lifter Rock Lever 227781 with two each 202451 and 202452	50
227787	—	Knee Lifter Rock Lever 227782 with 202203 and 227784	90
202453	11707	Knee Lifter Rock Lever Knee Plate with 200526c	17
202203	—	Knee Lifter Rock Lever Knee Plate 202453 with 202454	30
202454	11707	Knee Lifter Rock Lever Knee Plate Arm (long)	12
200522c	12319	Knee Lifter Rock Lever Knee Plate Arm Set Screw	06
200526c	12319	Knee Lifter Rock Lever Knee Plate Set Screw	05
202451	11707	Knee Lifter Rock Lever Lug with two wood screws ¾ in., No. 13H..	05
202452	12319	Knee Lifter Rock Lever Lug Hinge Pin	02

No.	Plate	Name	Each
227784	11707	Knee Lifter Rock Lever Rod, 3 in. long, with 227785	\$ 06
*227785	—	Knee Lifter Rock Lever Rod Cap or Oil Guard	—
200529c	12319	Knee Lifter Rock Lever Rod Set Screw	05

(Other Knee Lifter Parts are listed with parts of machine head).

FOR MACHINES NOS. 121W2 AND 121W3

Same as for No. 121w1 with the following exceptions:

227678	11704	Feed Reversing Lever Chain, 48 in. long, with 202784	25
202784	11701	Feed Reversing Lever Chain Hook	02
213701	11077	“ “ “ “ Lever with 213504, 213700 and two wood screws 1 in., No. 13	50
213700	11073	Feed Reversing Lever Chain Lever Hinge Pin	05
213504	11077	Feed Reversing Lever Chain Lever Lug	15

FOR MACHINES NOS. 122W1 AND 122W2

Same as for No. 121w1 with the following exceptions:

213783	11064	Bobbin (10), in place of (5)	08
19 N1	—	Needles, four each, sizes 16, 18 and 20, in place of two each, sizes 16, 18 and 20	30

PRESSER FEET

FOR MACHINES OF CLASS 121W

No.	Plate	Name	Each
229752	11079	Lifting Presser Foot, for 229751 ..	\$1 00
229754	11079	“ “ “ “ 229753 ..	1 00
229760	11079	“ “ “ “ 229751 ..	1 00
229762	11080	“ “ “ “ 229761 ..	1 00
229755	11080	“ “ “ “ 229751 ..	1 00
229945	11706	“ “ “ “ 229946 ..	1 00
229947	11706	“ “ “ “ 229948 ..	1 00
226852	11706	“ “ “ “ 226853 ..	1 00
229818	11706	“ “ “ “ 229751 ..	1 00
221578	11706	“ “ “ “ 221579 ..	1 00
221579	11706	Vibrating Presser Foot, 46 needle hole, with 200941c, for 221578 ..	1 25
221582	11079	Vibrating Presser Foot, 46 needle hole, with 200941c, for 221578 ..	1 25
229751	11079	Vibrating Presser Foot, 46 needle hole, with 200941c, for 229752, 229755, 229760 and 229818	1 25
229753	11079	Vibrating Presser Foot, 50 needle hole, with 200941c, for 229754 ..	1 25
229761	—	Vibrating Presser Foot, 46 needle hole, with 200941c, for 229762 ..	1 25
229946	11706	Vibrating Presser Foot, 46 needle hole with 200941c, for 229945 ..	1 25
229948	11706	Vibrating Presser Foot, 40 needle hole, with 200941c, for 229947 ..	1 25
226853	11706	Vibrating Presser Foot, with 200941c, for 226852	1 25
200941c	11701	Vibrating Presser Foot Pinch Screw	03

FOR MACHINES OF CLASS 122W

229756	11080	Lifting Presser Foot, for 229757, in gauges from $\frac{1}{4}$ to $\frac{1}{2}$ in., in steps of $\frac{1}{32}$ inch	1 25
229759	11080	Lifting Presser Foot, for 221611, 229757 and 229758, in gauges from $\frac{1}{4}$ to 1 in., in steps of $\frac{1}{32}$ inch ...	2 75
229833	11706	Lifting Presser Foot, for 229834, in gauges $\frac{1}{8}$, $\frac{5}{32}$, $\frac{3}{16}$ and $\frac{3}{32}$ inch	1 00

No.	Plate	Name	Each
229825	11706	Lifting Presser Foot, for 221611 and 229758, in gauges from $\frac{1}{16}$ to 1 in., in steps of $\frac{1}{32}$ inch	\$1 25
229757	11080	Vibrating Presser Foot, 50 needle hole, in gauges from $\frac{1}{4}$ to $\frac{1}{2}$ in., in steps of $\frac{1}{32}$ in., with 200941c, for 229756 and 229759	1 80
229758	11080	Vibrating Presser Foot, 50 needle hole, in gauges from $\frac{1}{16}$ to 1 in., in steps of $\frac{1}{32}$ in., with 200941c, for 229759 and 229825	2 00
229834	11706	Vibrating Presser Foot, 50 needle hole, in gauges $\frac{1}{4}$, $\frac{3}{8}$, $\frac{1}{2}$ and $\frac{3}{4}$ in., with 200941c, for 229833	1 50
221611	11080	Vibrating Presser Foot, 46 needle hole, in gauges from $\frac{1}{16}$ to 1 in., in steps of $\frac{1}{32}$ in., with 200941c, for 229759 and 229825	2 00

THROAT PLATES

FOR MACHINES OF CLASS 121W

212841	11074	Throat Plate, 53 needle hole, for needle sizes 10 to 20	80
212842	11074	Throat Plate, 46 needle hole, for needle sizes 20 to 24	80
212856	11074	Throat Plate, 50 needle hole, for needle sizes 16 to 22	80
212616	11074	Throat Plate, 50 needle hole, for needle sizes 16 to 22	80

FOR MACHINE NO. 122W1

212846	11074	Throat Plate, 50 needle hole, for needle sizes 16 to 22, in gauges from $\frac{1}{8}$ to 1 in., in steps of $\frac{1}{32}$ inch	1 50
221542	11074	Throat Plate, 46 needle hole, for needle sizes 20 to 24, in gauges from $\frac{1}{8}$ to 1 in., in steps of $\frac{1}{32}$ inch	1 50

No.	Plate	Name	Each
FOR MACHINE NO. 122W2			
212847	11074	Throat Plate, 53 needle hole, for needle sizes 10 to 20, in gauges from $\frac{1}{8}$ to 1 in., in steps of $\frac{1}{32}$ inch	\$1 50
212857	11074	Throat Plate, 50 needle hole, for needle sizes 16 to 22, in gauges from $\frac{1}{8}$ to 1 in., in steps of $\frac{1}{32}$ inch	1 50

LAP SEAM EDGE GUIDE

(ADJUSTABLE)

FOR MACHINES OF CLASS 122W

230708	11709	Guide (adjustable) (lower)	1 75
230709	11708	" " (upper)	1 75
230710	11709	" Base	1 50
200170B	11709	" Screw	04
230455	11709	Lap Seam Edge Guide (adjustable) complete, Nos. 230708 to 230710 and two 200170B, for L, M, H, MH, XH, XXH, XXXH or XXXXH material	5 00

LAP SEAM FELLER

FOR MACHINES OF CLASS 122W

230053	11708	Lap Seam Feller (left hand), for $\frac{1}{8}$ to $\frac{3}{4}$ in. gauge, for L, M, MH, H, XH, XXH or XXXH material, has yielding spring	3 40
230054	11708	Lap Seam Feller (right hand), for $\frac{1}{8}$ to $\frac{3}{4}$ in. gauge, for L, M, MH, H, XH, XXH or XXXH material, has yielding spring	3 40

ROLLER WELT GAUGE

FOR MACHINES OF CLASS 121W

No.	Plate	Name	Each
226261	10557	Roller Welt Gauge with 201849 ...	\$1 50
226259	10557	" " " Frame with 226264	85
226273	—	Roller Welt Gauge Frame 226259 with 200297E, 226261 to 226263, two each 200056D and 202603	3 65
226824	11702	Roller Welt Gauge Frame Base Plate with 213478 and 213479 ..	65
213478	11063	Roller Welt Gauge Frame Base Plate Friction Slide	10
213479	11063	Roller Welt Gauge Frame Base Plate Friction Slide Spring	02
200056D	12319	Roller Welt Gauge Frame Screw	03
202603	10557	" " " " " Washer	01
226262	10557	Roller Welt Gauge Handle	1 00
226264	10557	" " " " " (leather)	02
200297E	10557	Roller Welt Gauge Handle Hinge Screw	05
201849	10557	Roller Welt Gauge Roller 201836 with 206521	20
206521	10557	Roller Welt Gauge Roller Stud	05
226263	10557	" " " Spring	10
226825	11702	Roller Welt Gauge complete, Nos. 226273 and 226824	4 30

FOLDER

FOR MACHINE NO. 121W1

For folding the edge of brim of soft felt hats.

No.	Plate	Name	Each
221577	11711	Edge Folder on Shank, in gauges from $\frac{1}{8}$ to $\frac{3}{8}$ in., in steps of $\frac{1}{32}$ inch	\$3 75
221578	11706	Lifting Presser Foot, for 221579 and 221582	1 00
221582	11079	Vibrating Presser Foot, 46 needle hole, with 200941c, for 221578, for use with 221577, in gauges from $\frac{1}{8}$ to $\frac{7}{32}$ inch	1 25
221579	11706	Vibrating Presser Foot, 46 needle hole, with 200941c, for 221578, for use with 221577, in gauges from $\frac{1}{8}$ to $\frac{3}{8}$ inch	1 25

OBSOLETE PARTS

213458	11183	Face Plate with 200368H, 200739F, 202087, 202090, 213592, 213691, 221546 and four 200397H	1 50
213459	11183	Face Plate complete, Nos. 200577H, 202088, 204272, 204280, 213458, 213500, 213690 and two 200309E..	3 00
213462	11066	Feed Eccentric	1 00
*213431	—	Hook (sewing)	—
213694	11064	" 213431 with 200088F, 213438 and 213644	5 00
213497	11069	Take-up Cam with 200335c, 200383c and 200430c	1 50

PLATE 10557-FULL SIZE

226259

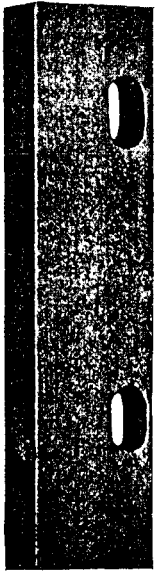

226261



226262

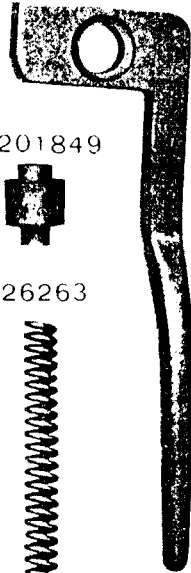

201849



226263



200056

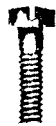

226264



200297



206521



202603



PLATE 11055—ONE-HALF SIZE

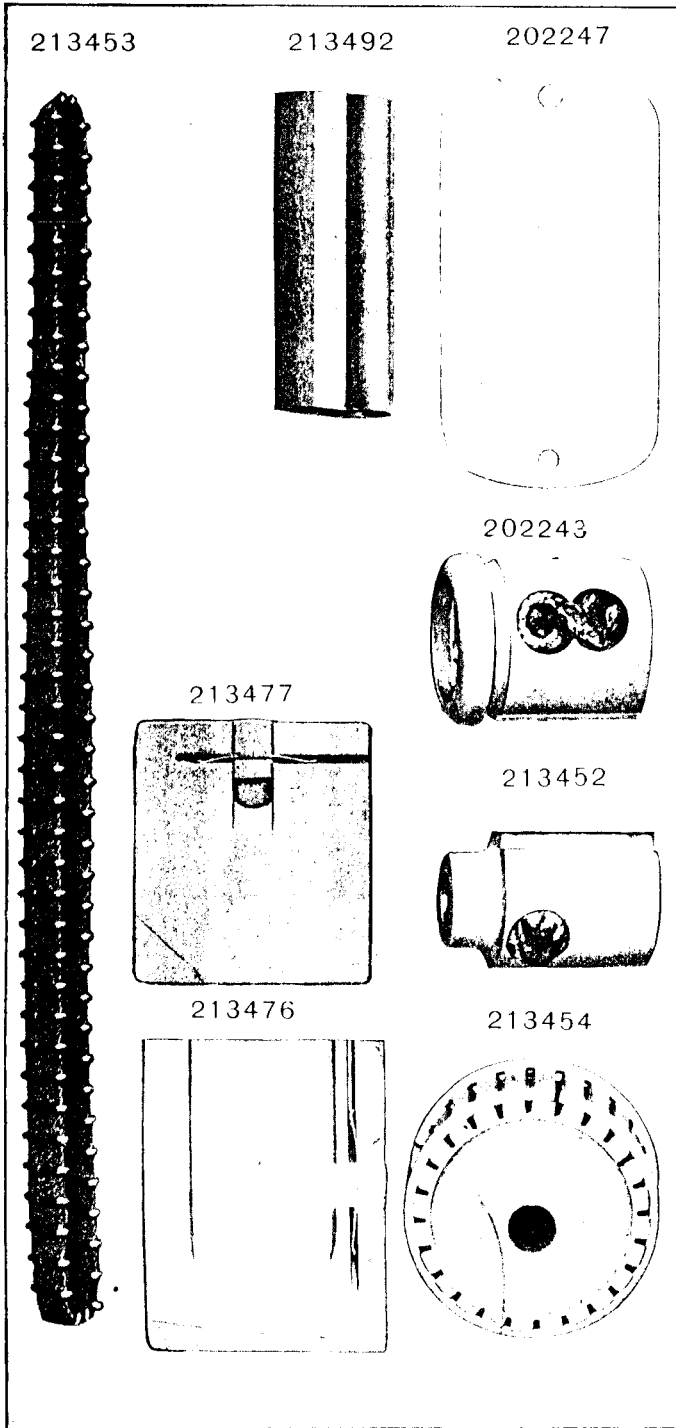

PLATE 11063—FULL SIZE

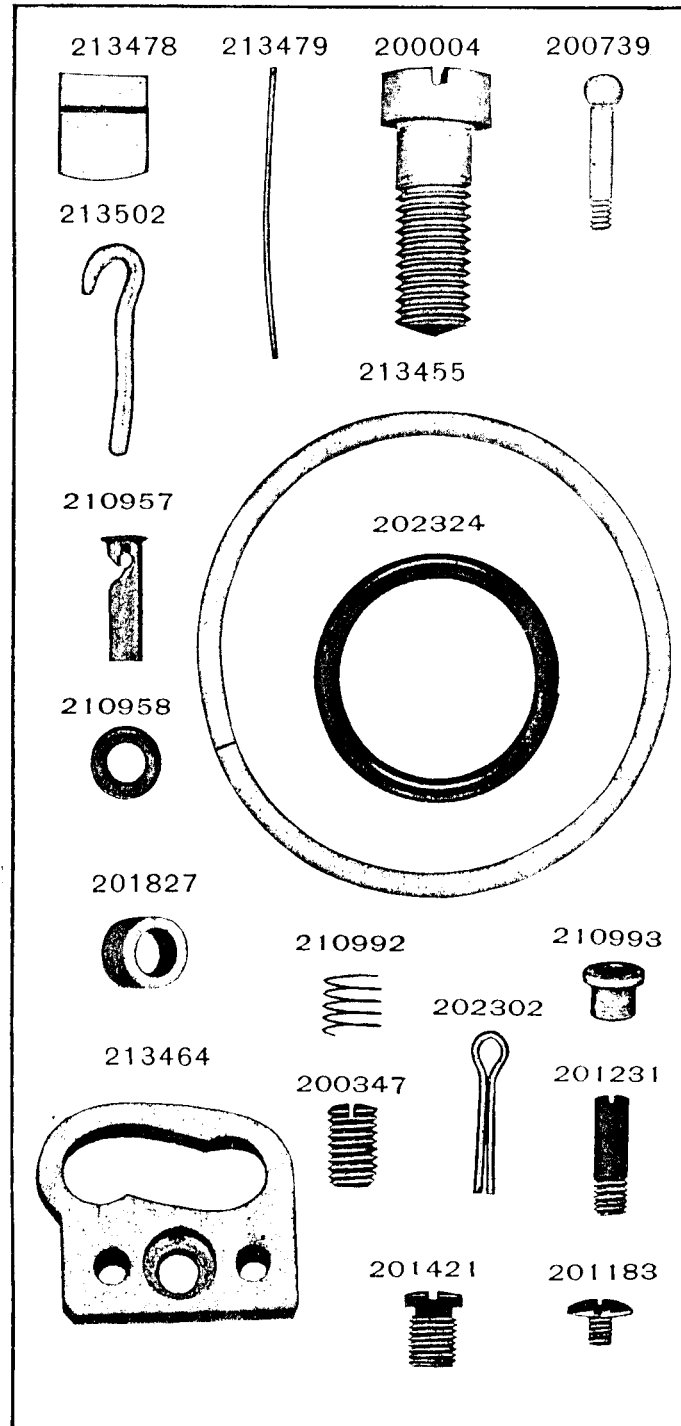

PLATE 11064-FULL SIZE

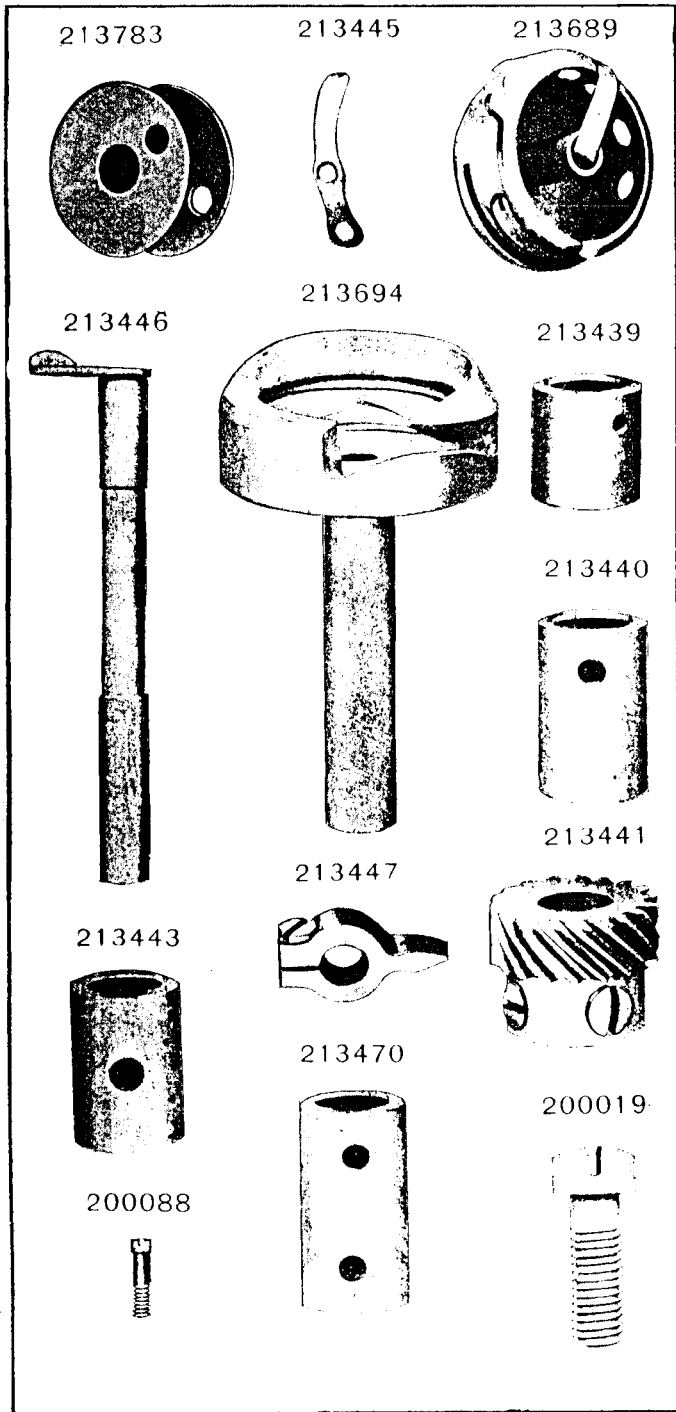

PLATE 11066-FULL SIZE

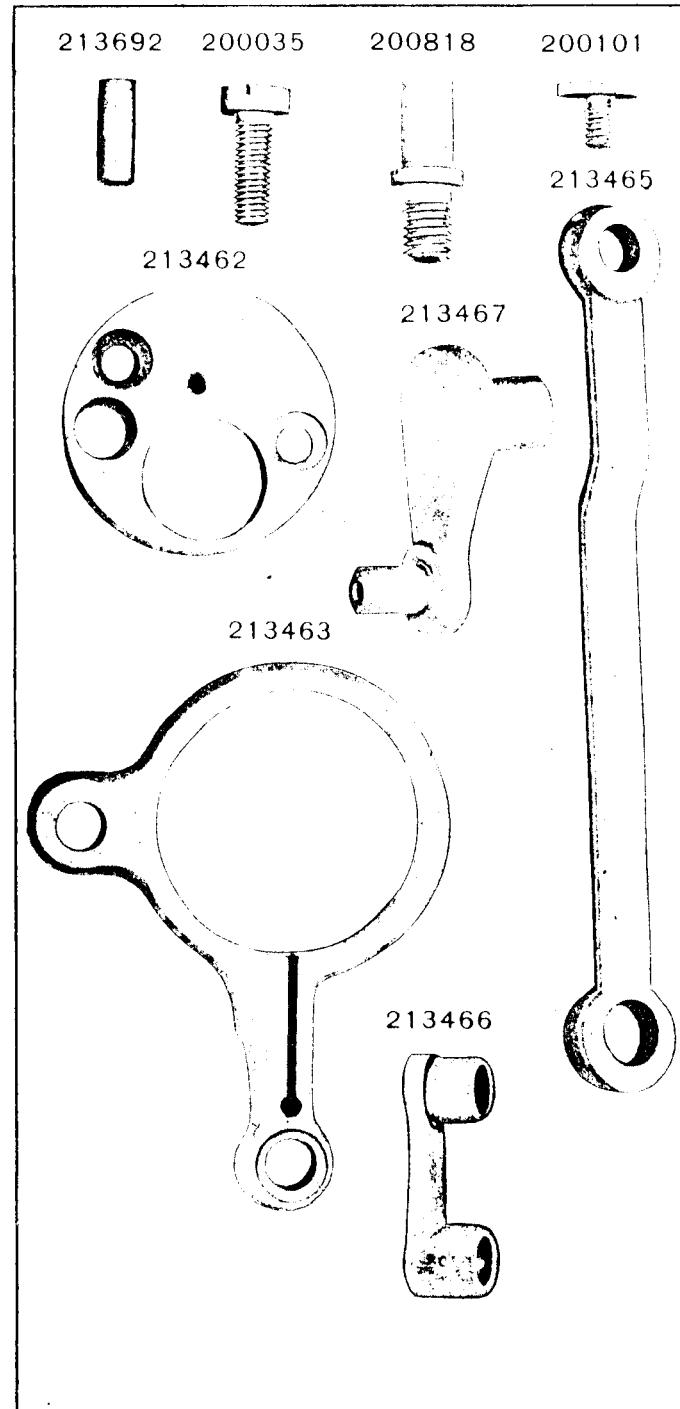
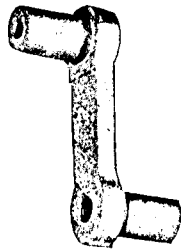

PLATE 11067—FULL SIZE

225832



213461



213696

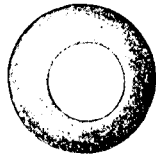

200095



200681



213494

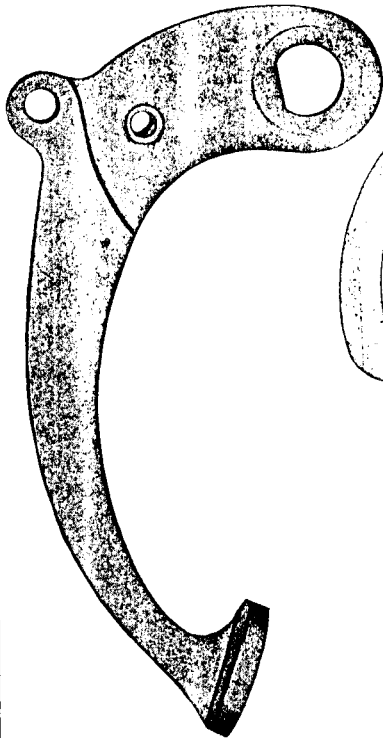

213496

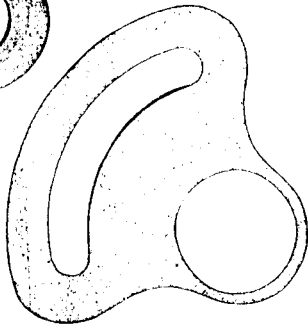
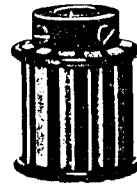
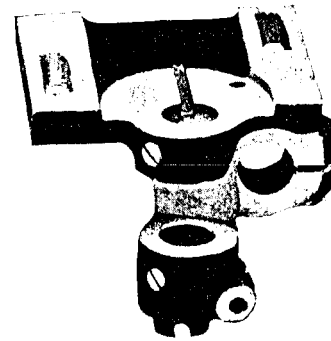

PLATE 11069—ONE-HALF SIZE

221576



213442



213497

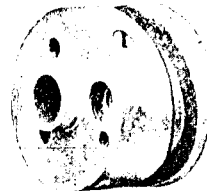

213521

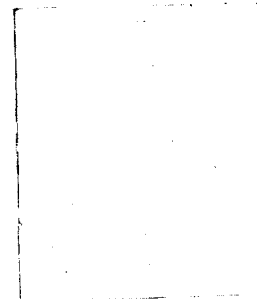

213616

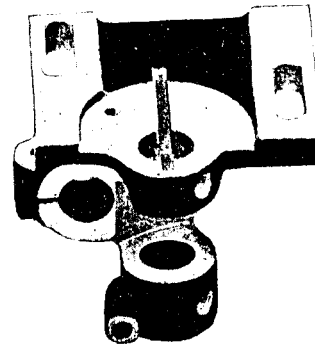

213522

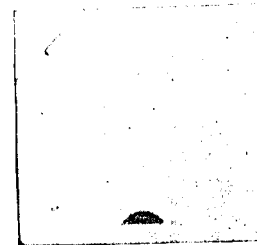

PLATE 11070—FULL SIZE

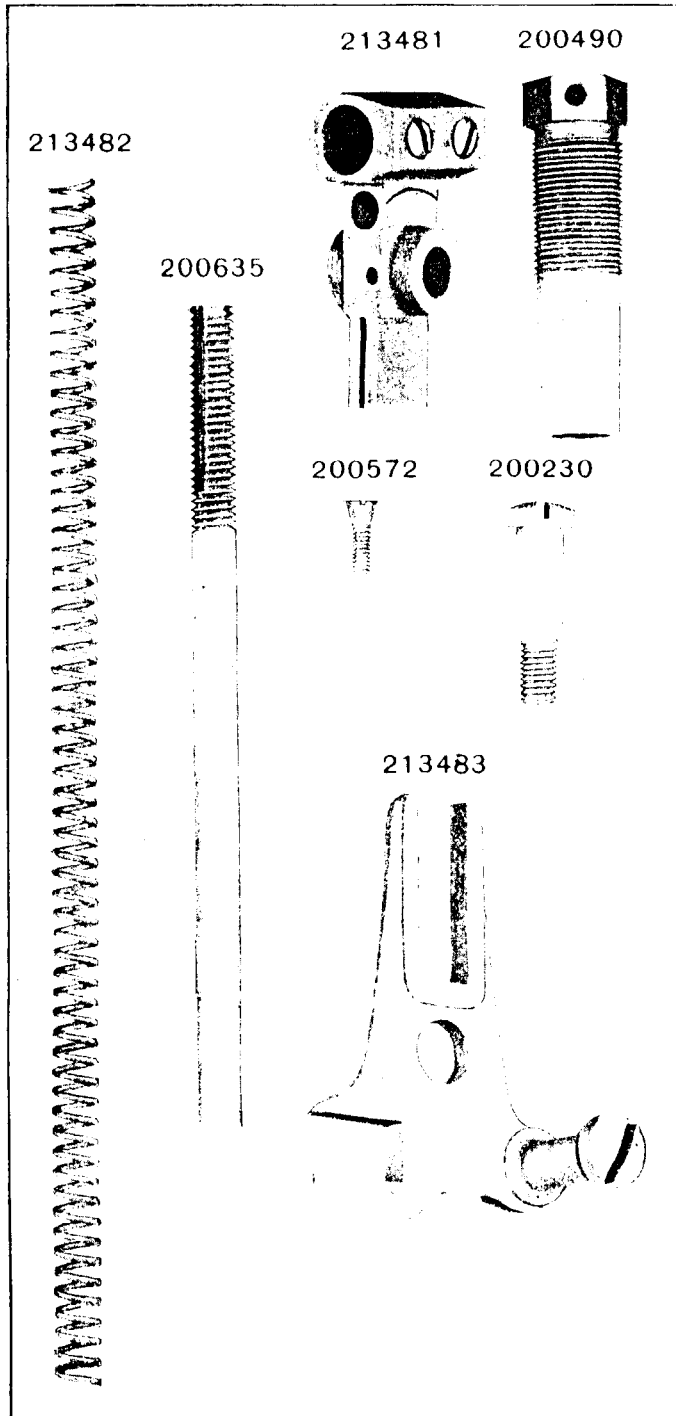

PLATE 11071—FULL SIZE

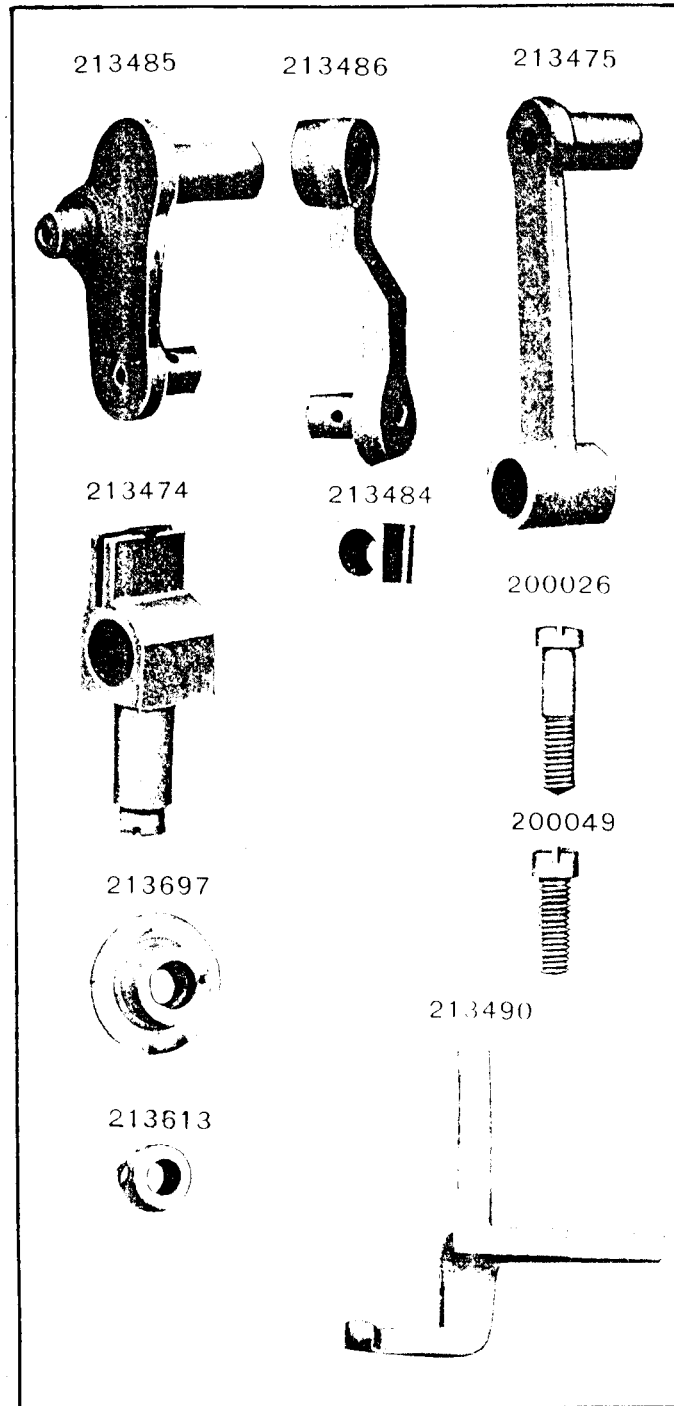

PLATE 11072—FULL SIZE

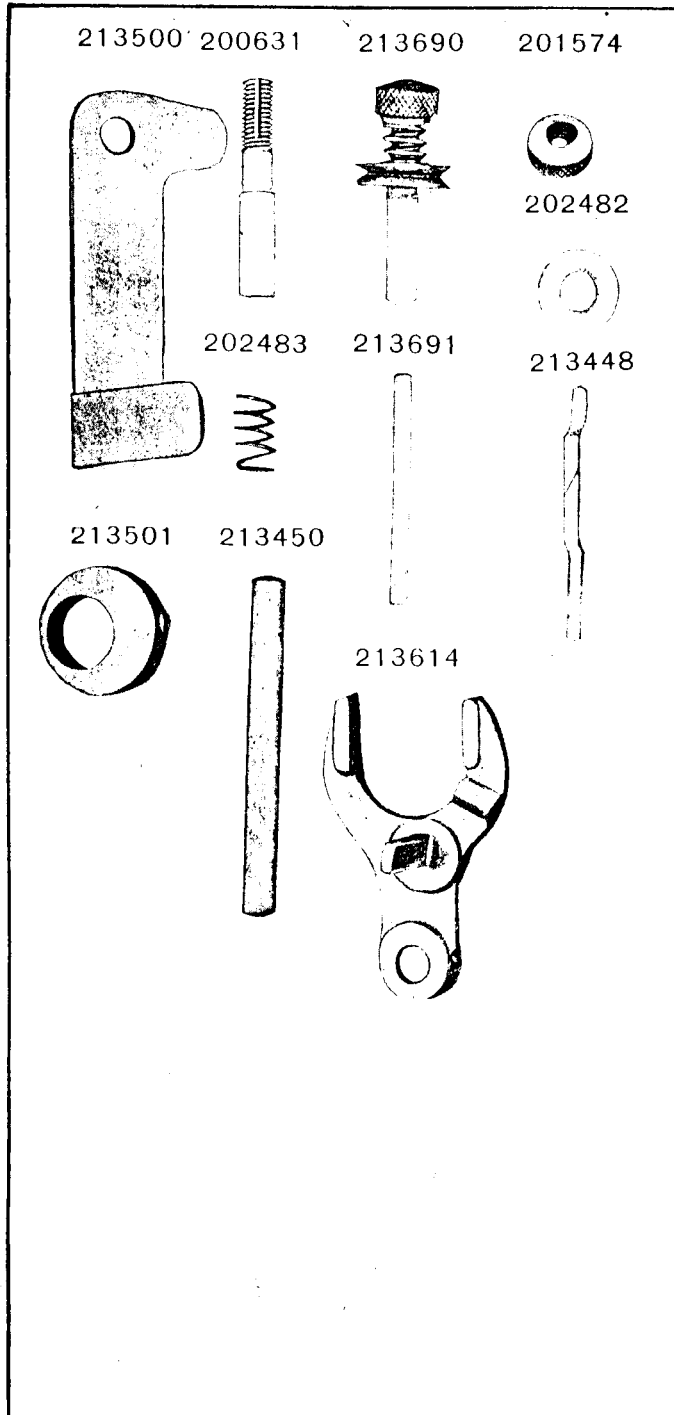

PLATE 11073—FULL SIZE

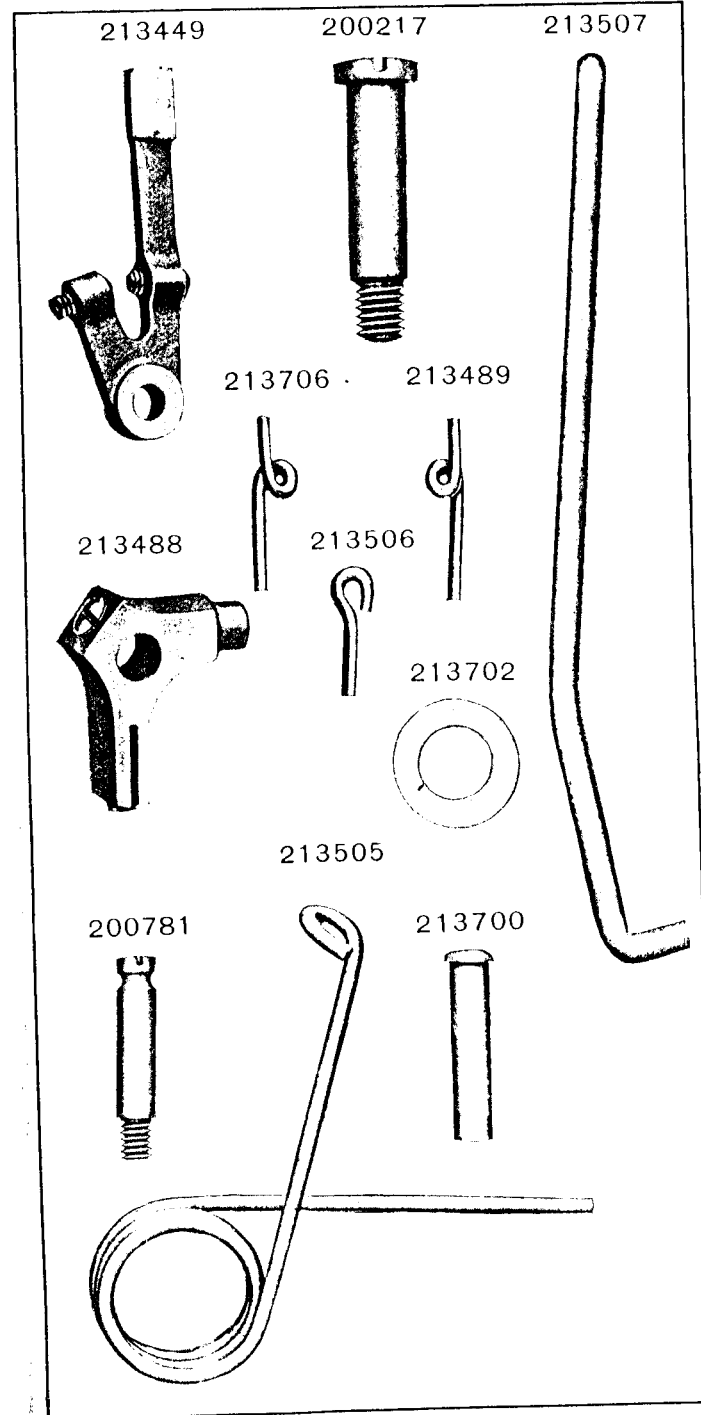
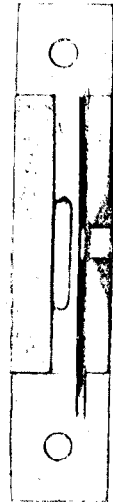

PLATE 11074-FULL SIZE

212841
212842
212856



212841
212842
212856



212846
221542

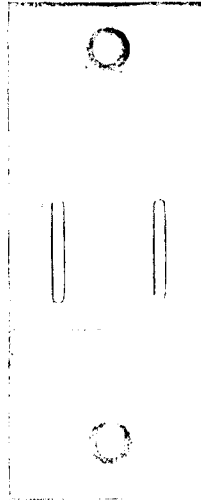

212616

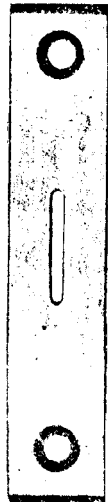

212847
212857

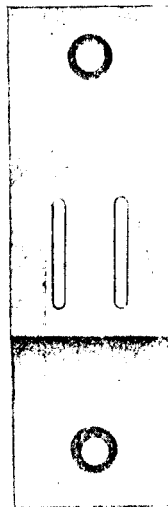
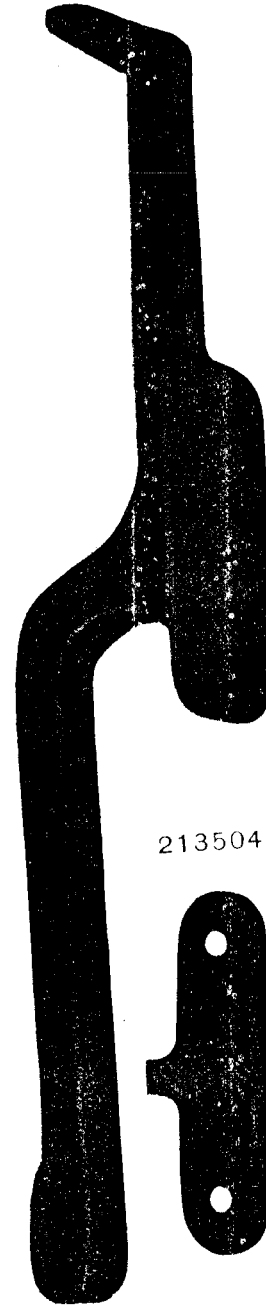

PLATE 11077-ONE-HALF SIZE

213503



213701



213504



PLATE 11078—FULL SIZE

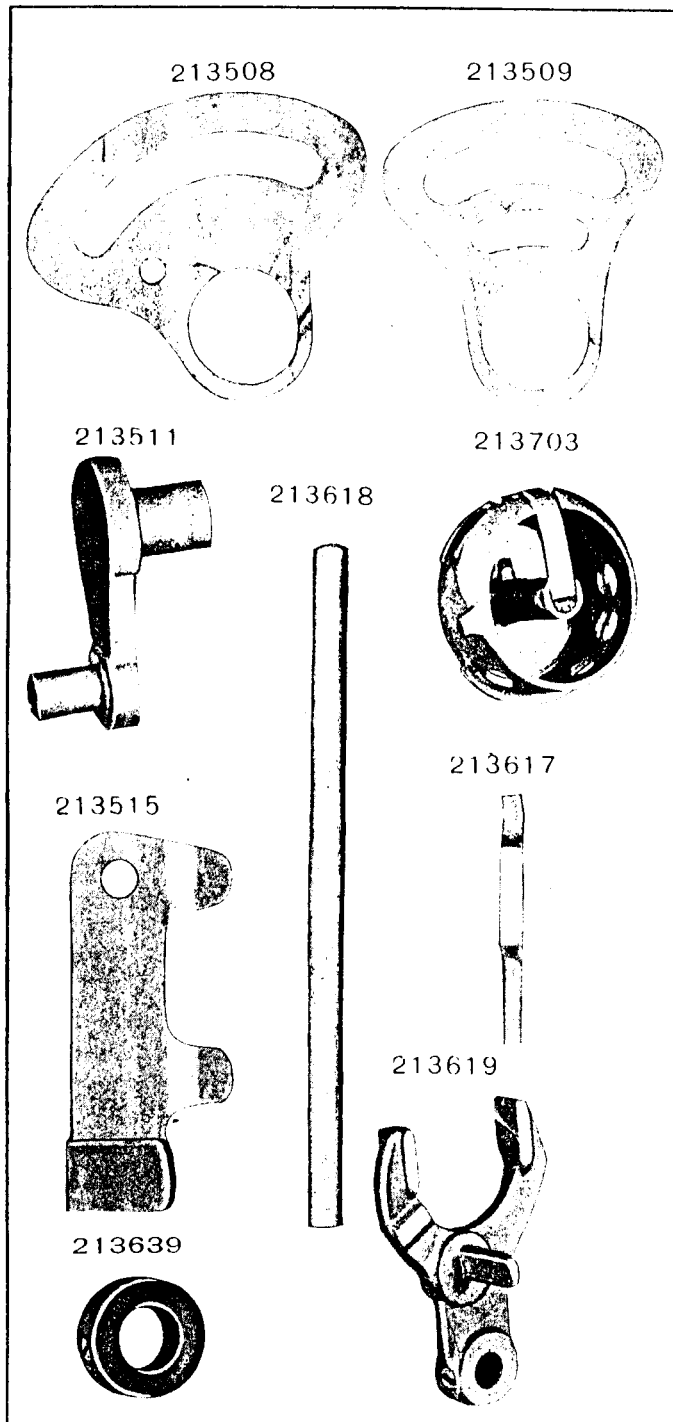

PLATE 11079—FULL SIZE

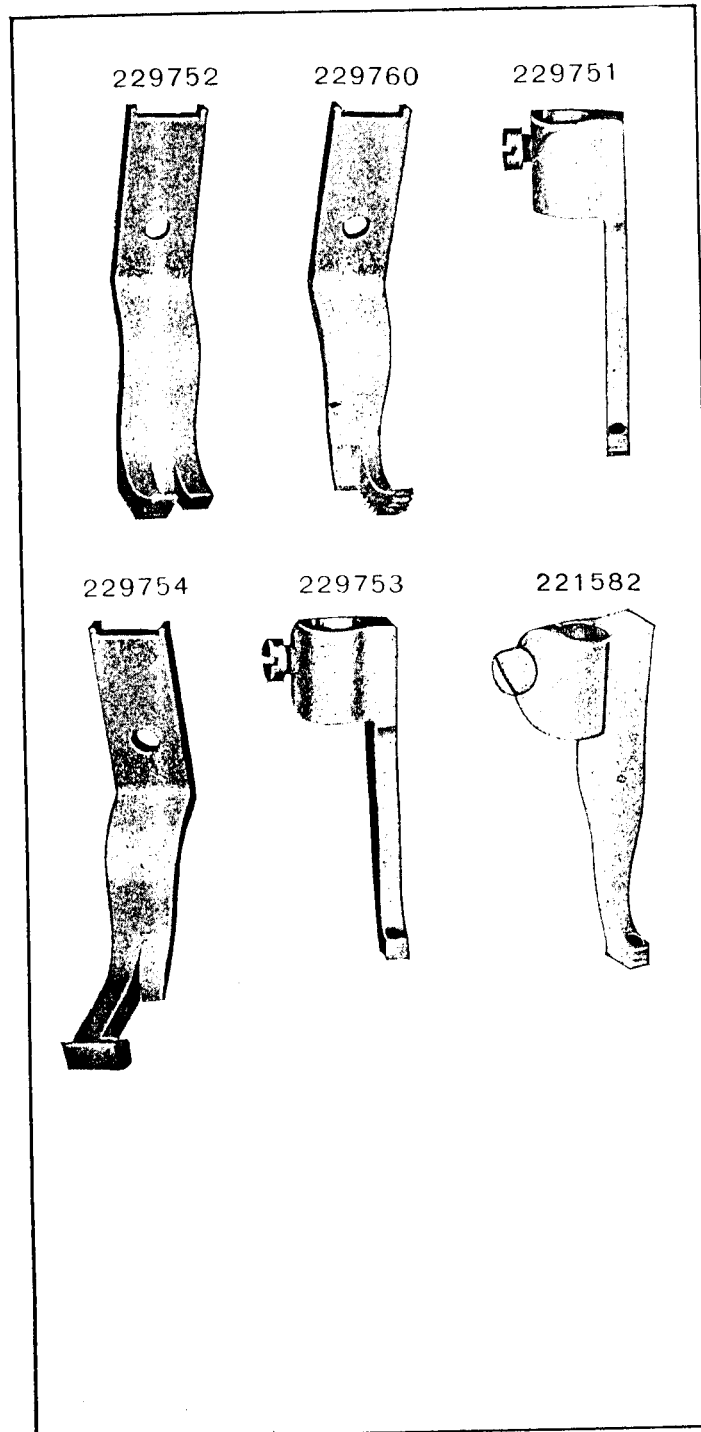

PLATE 11080—FULL SIZE

229756



229755



229757



221611
229758



229759

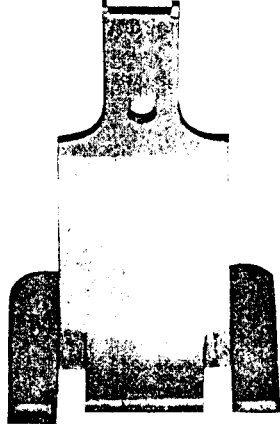

229762



PLATE 11183 ONE-FOURTH SIZE

213458

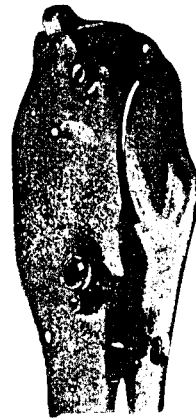

213459



213491

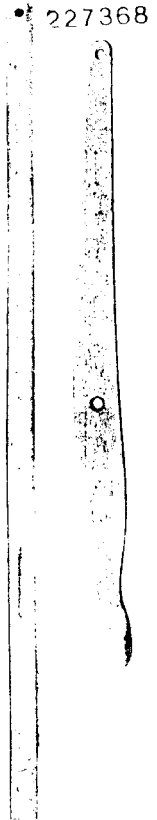

213471

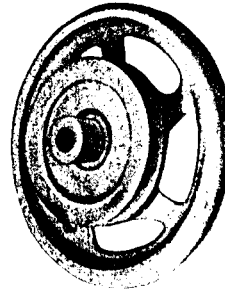

221581

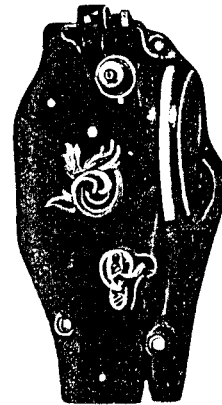

PLATE 11185—ONE-HALF SIZE

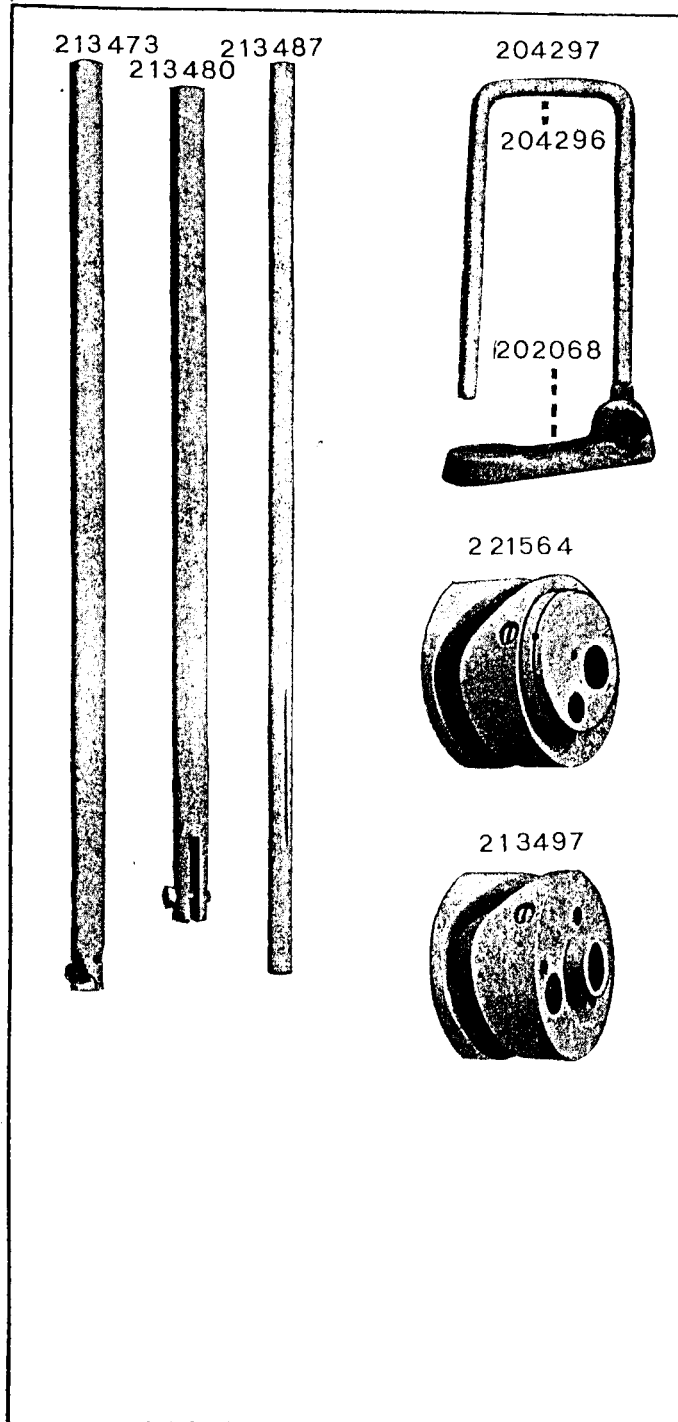

PLATE 11701—FULL SIZE

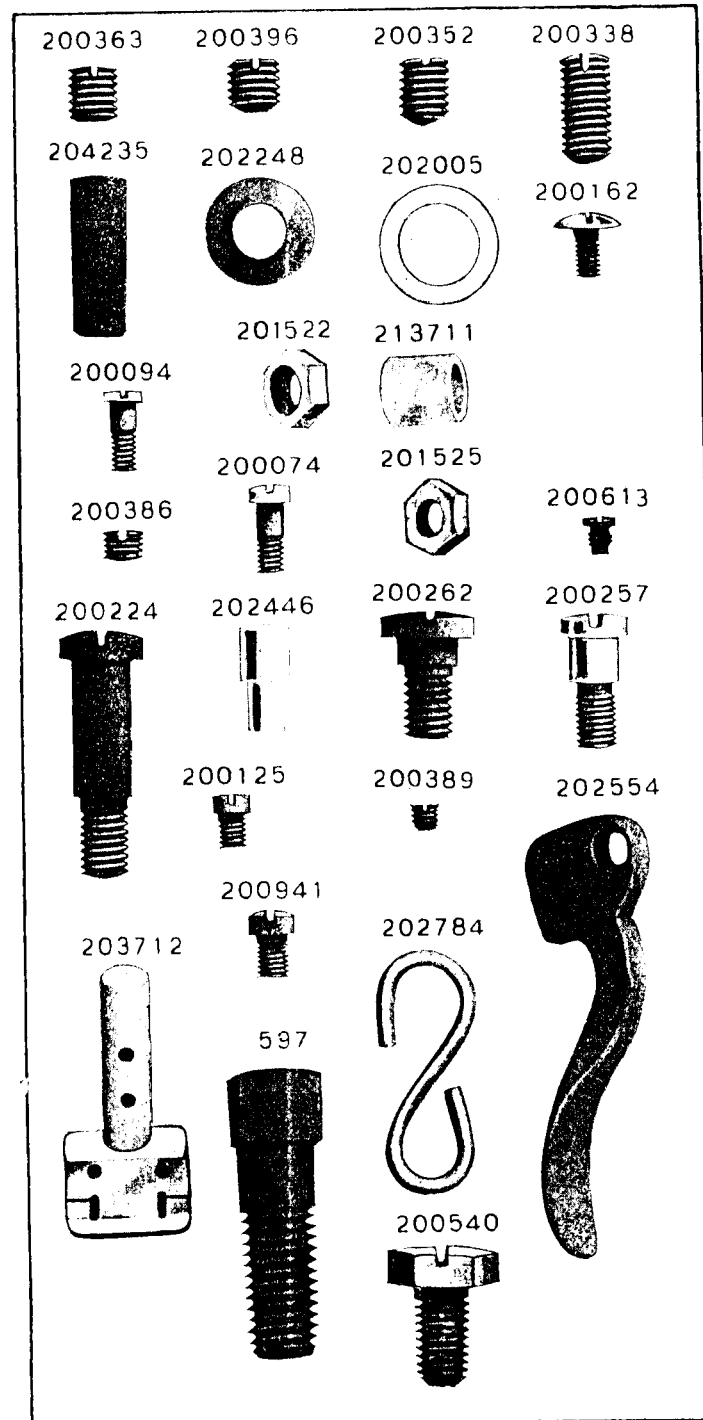

PLATE 11702 ONE-HALF SIZE

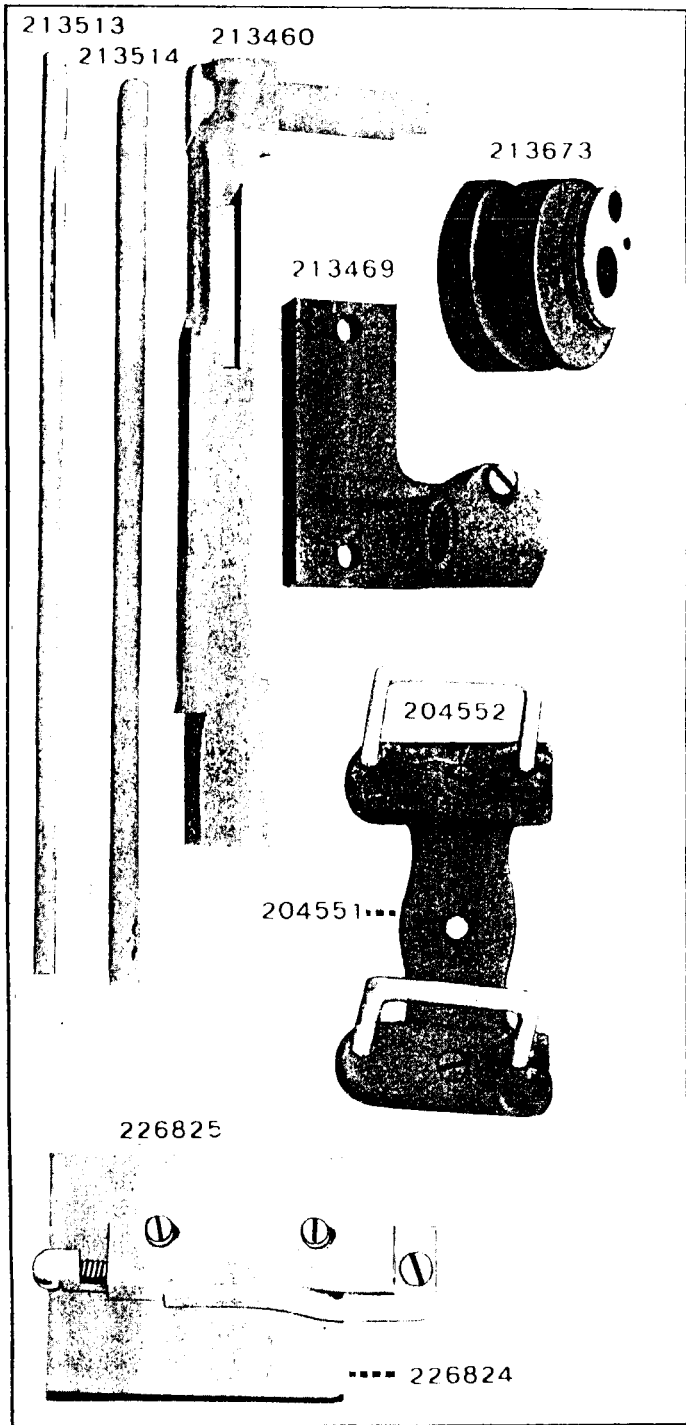

PLATE 11703—FULL SIZE

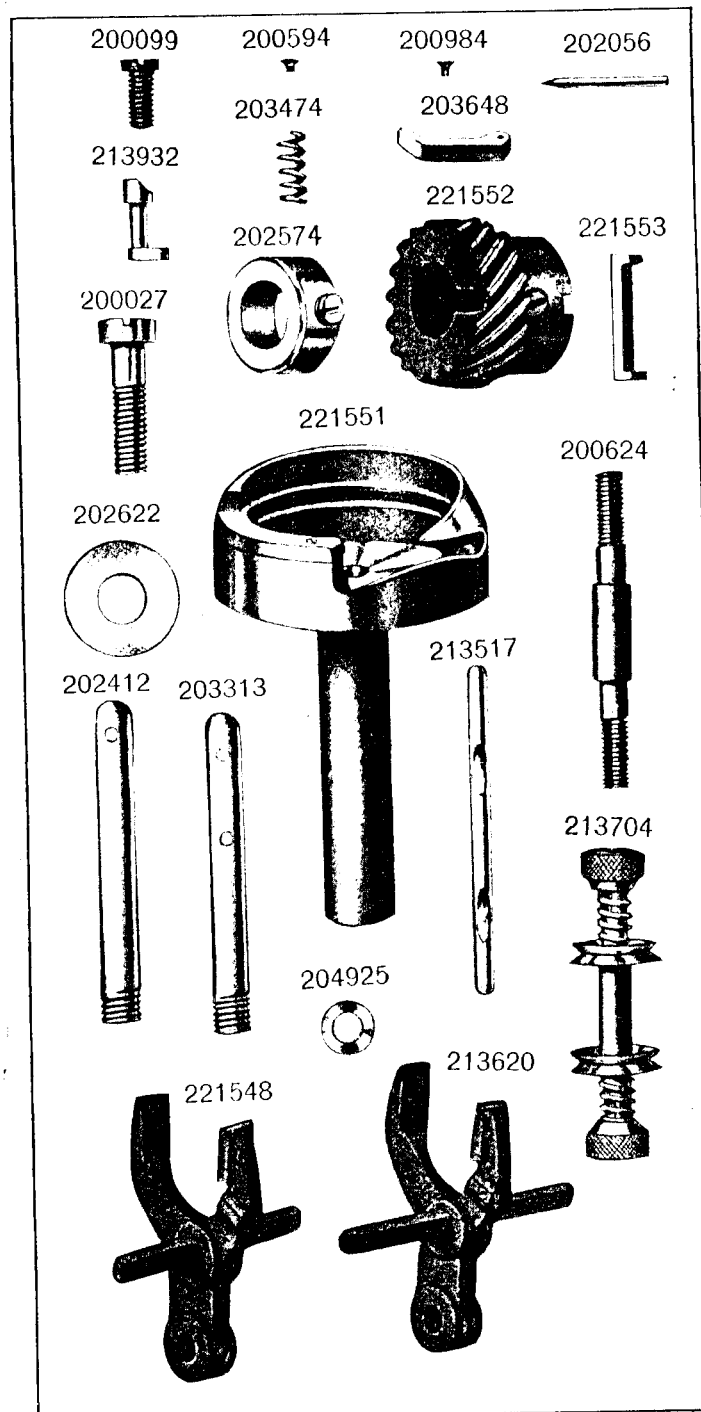
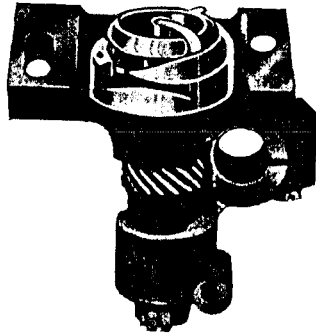
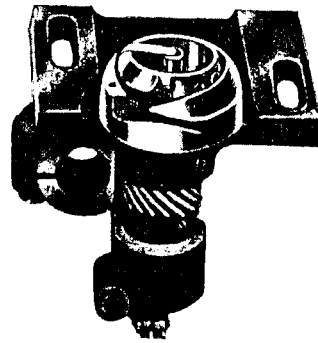

PLATE 11704--ONE-HALF SIZE

221555



221556



227678

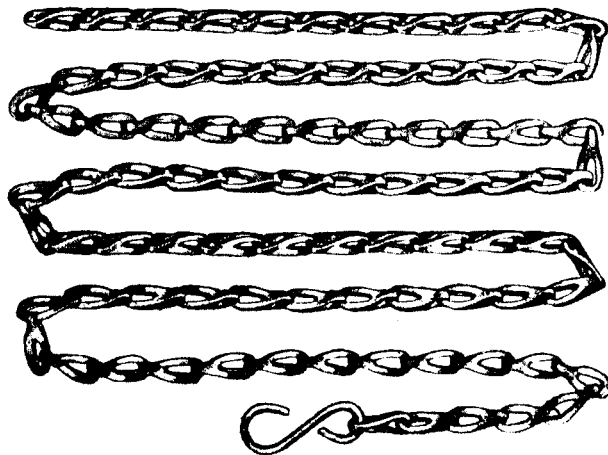
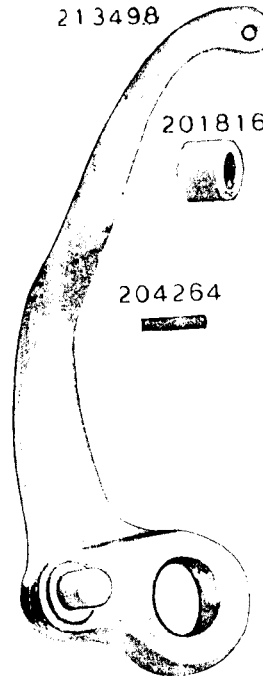
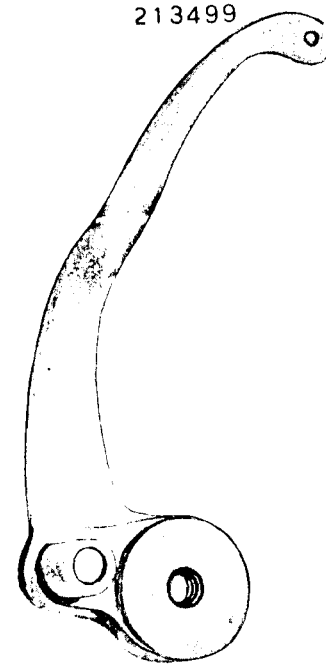

PLATE 11705--FULL SIZE

213498



213499



204264



213705

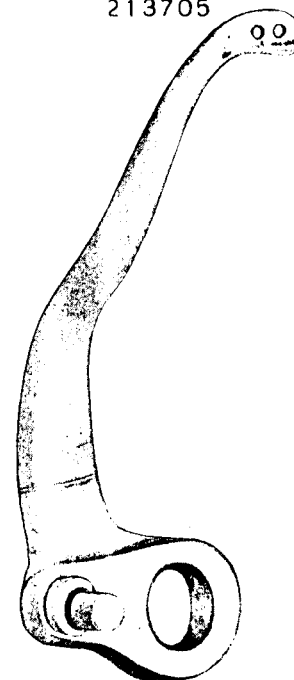

213516

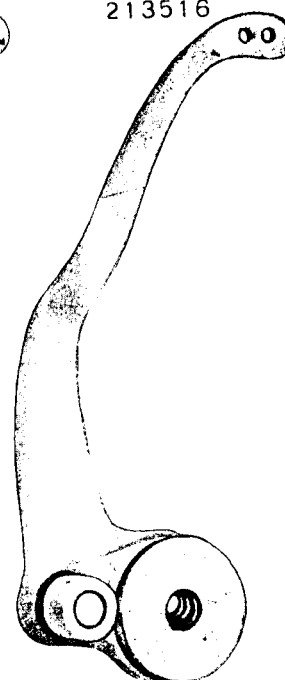

PLATE 11706-FULL SIZE

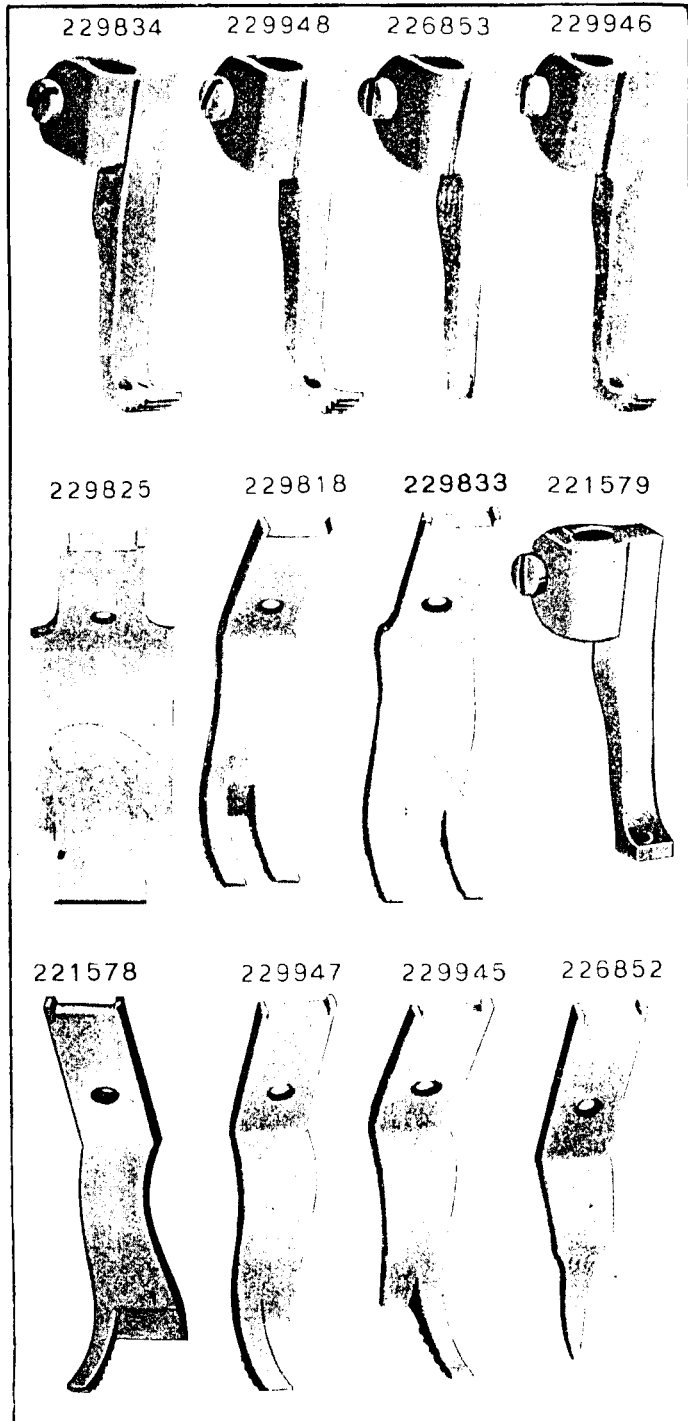

PLATE 11707-ONE-FOURTH SIZE

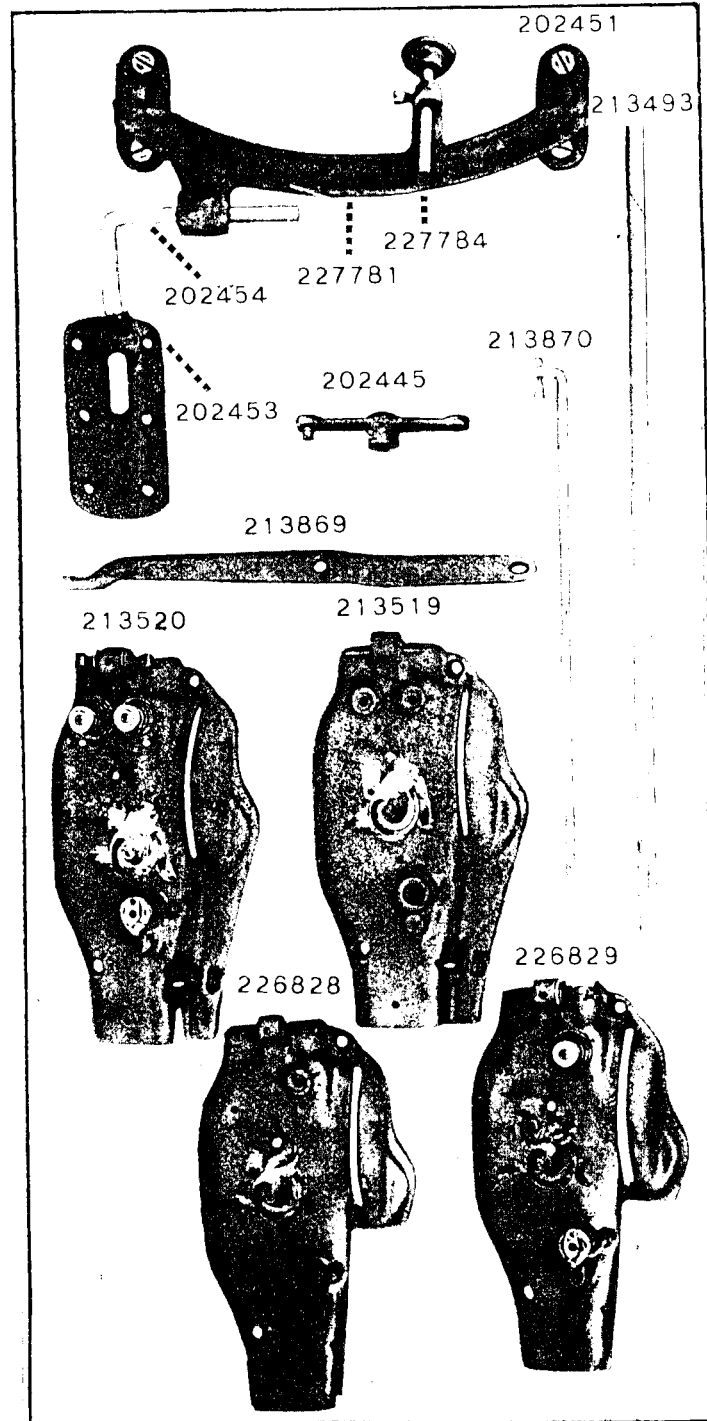
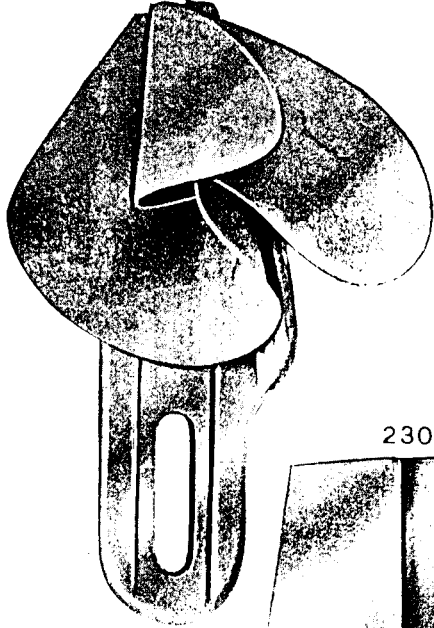
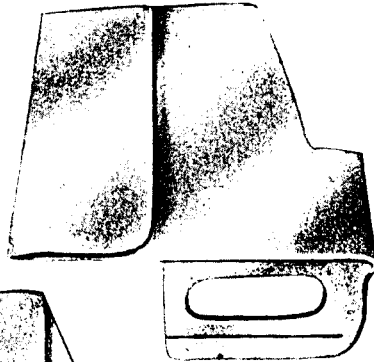

PLATE 11708-FULL SIZE

230054



230709



230053

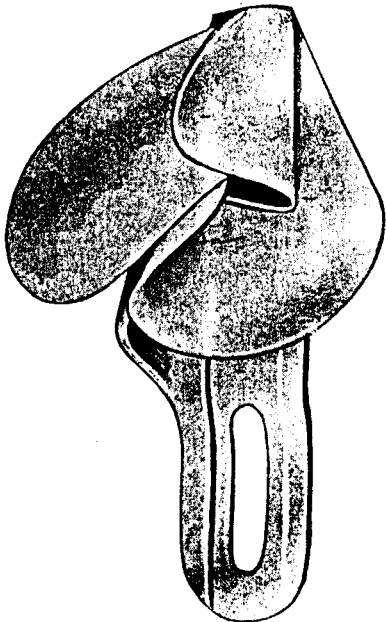
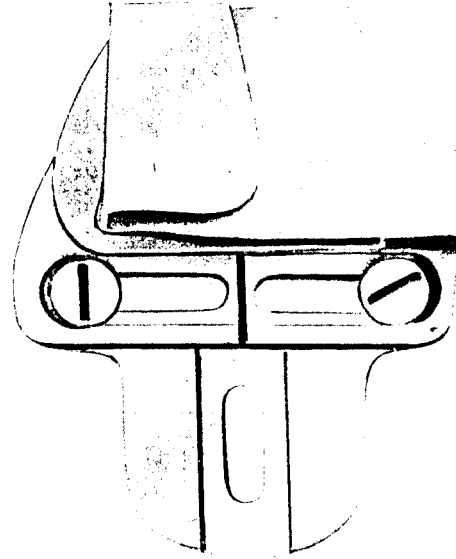

PLATE 11709-FULL SIZE

230455



200170



230710

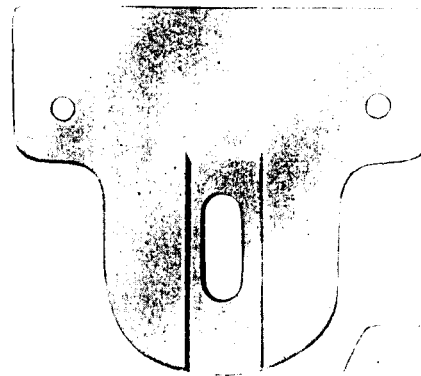

230708

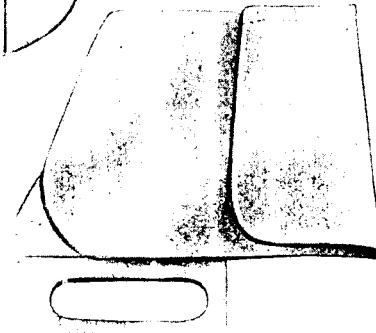
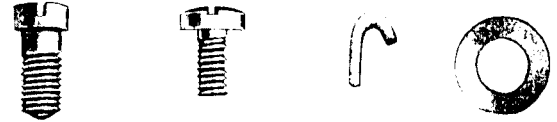

PLATE 11710--FULL SIZE

200281 200172 200103 200164



200058 200077 204190 206216



226848 226847 226843

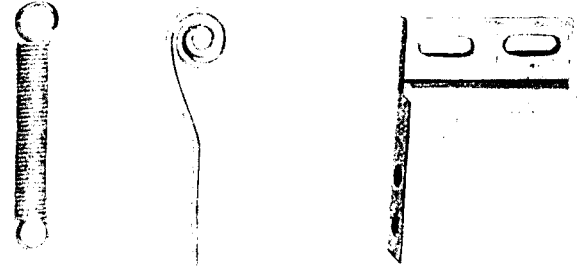

226842 226845



PLATE 11711--ONE-HALF SIZE

226841 226844 226849



221577

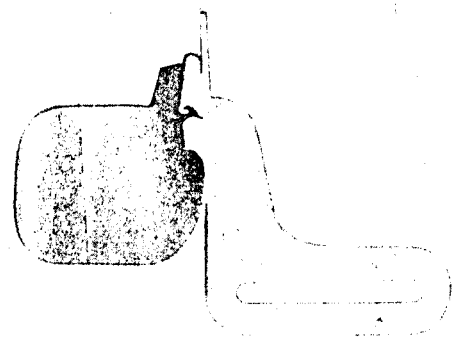

PLATE 12153—ONE-HALF SIZE

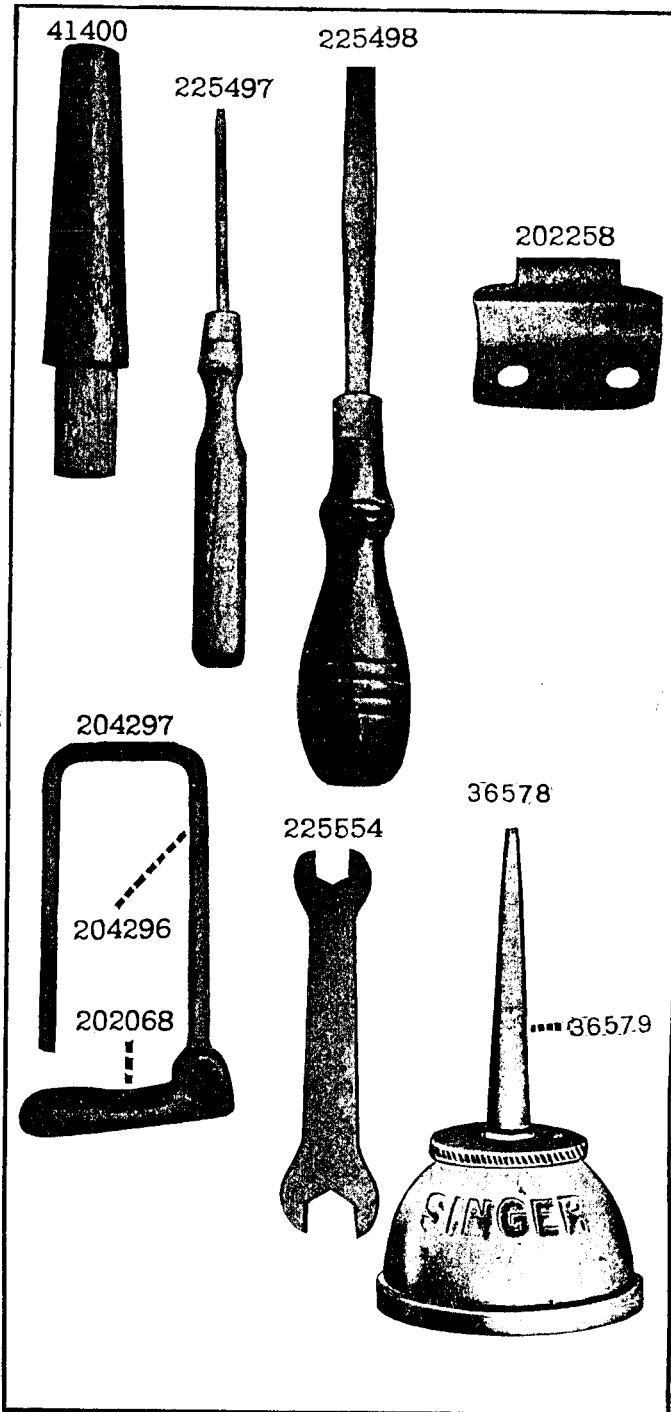

PLATE 12311—FULL SIZE

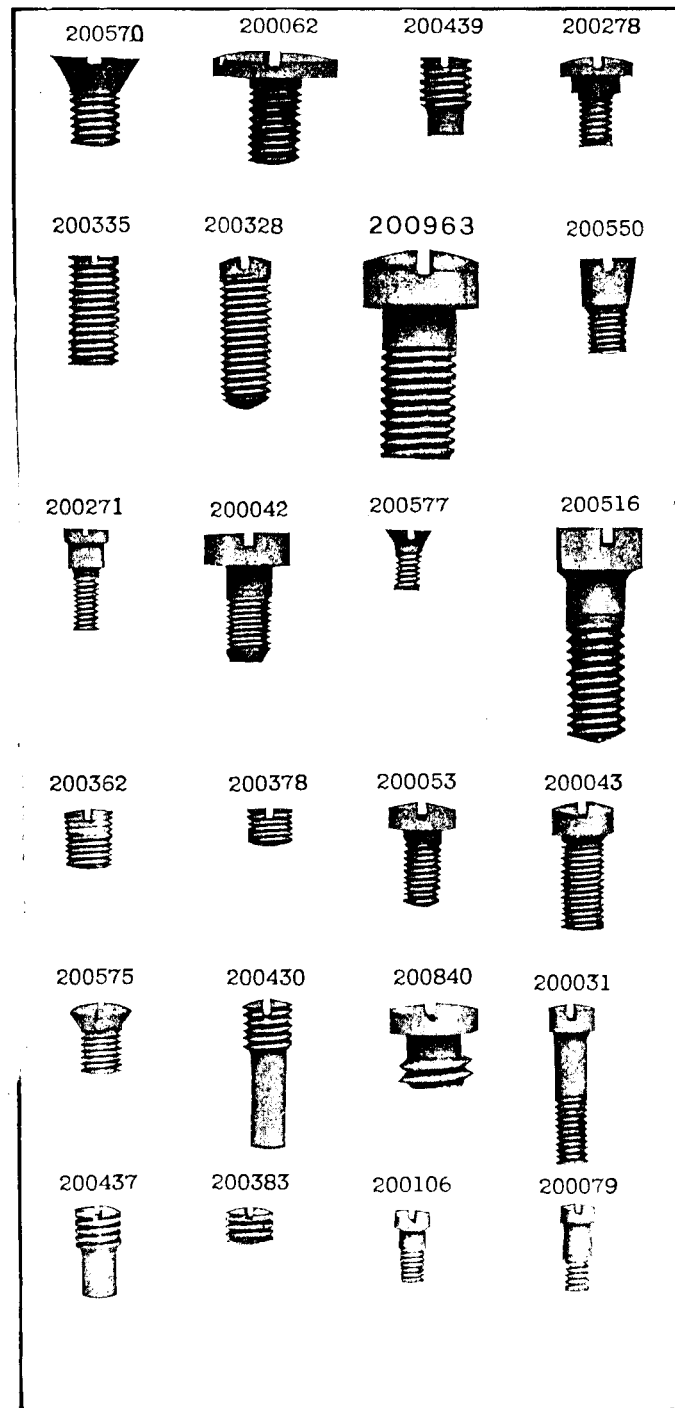

PLATE 12319 - FULL SIZE

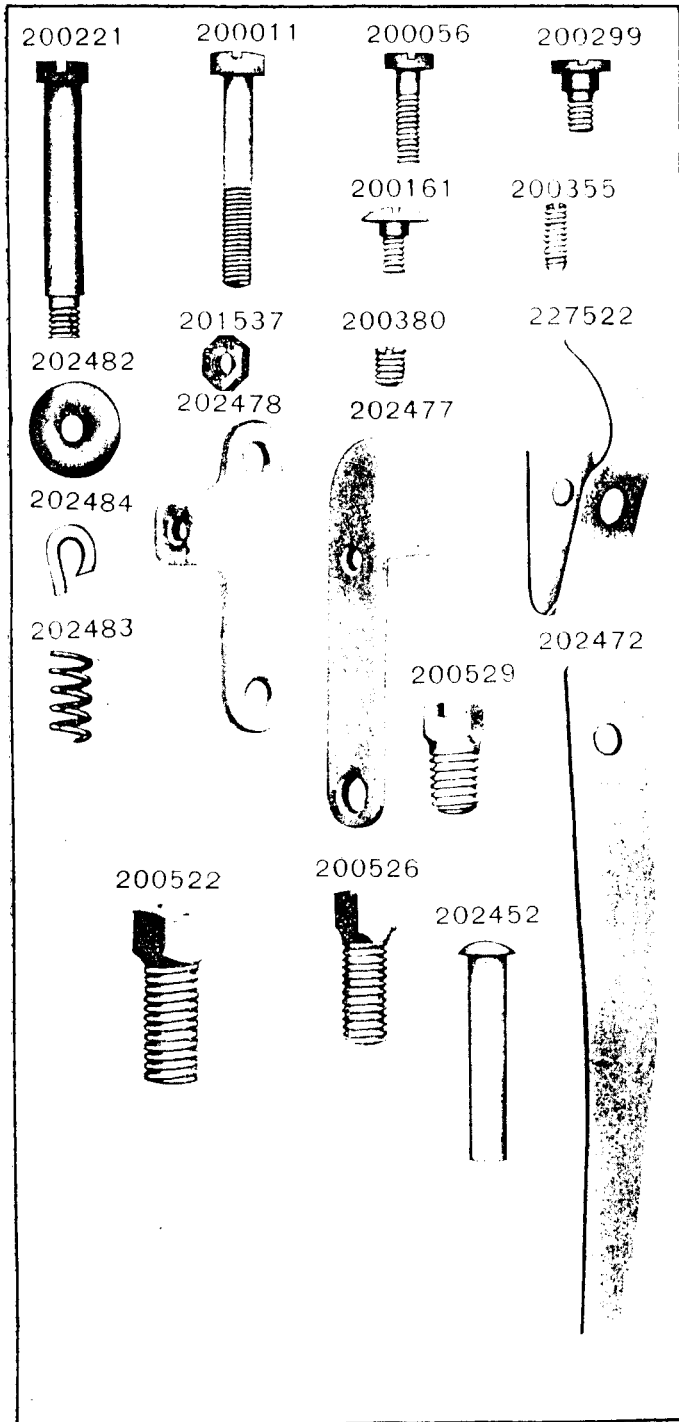

PLATE 12320 - ONE-HALF SIZE

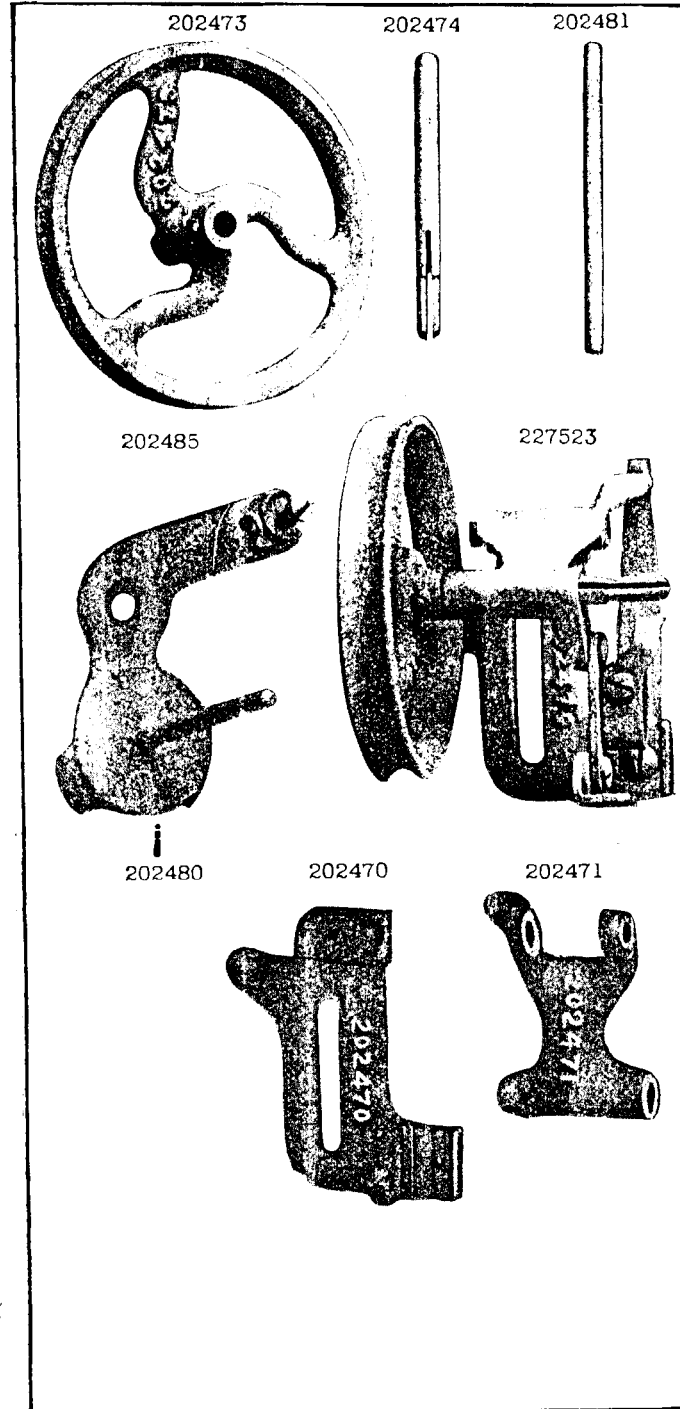

PLATE 12349-FULL SIZE

