

SINGER
140W1

USE ONLY SINGER OILS and LUBRICANTS

*They insure freedom from lubricating trouble and
give longer life to sewing equipment*

“Singer Oil for High Speed Sewing Machines”

(Cloth and Leather)

For all manufacturing sewing machines except where a stainless oil is desired.

“Singer Stainless Oil for High Speed Sewing Machines”

For all manufacturing sewing machines where a stainless oil is desired.

“Singer Motor Oil”

For oil-lubricated motors, power tables, transmitters and machinery in general.

“Singer Stainless Thread Lubricant”

For lubricating the needle thread of sewing machines for stitching fabrics or leather where a stainless thread lubricant is required.

NOTE: All of the above oils are available in 1 quart, 2 quart, 1 gallon and 5 gallon cans or in 55 gallon drums, and can also be supplied in customer's containers.

“Singer Gear Lubricant”

This specially prepared grease is recommended for gear lubrication on manufacturing sewing machines.

“Singer Ball Bearing Lubricant”

This pure grease is specially designed for the lubrication of ball bearings and ball thrust bearings of motors and electric transmitters, ball bearing hangers of power tables, etc.

NOTE: The above greases are furnished in 1 lb. and 4 lb. tins

Copyright, U. S. A.,
1914, 1915, 1924, 1932, 1934, 1935, 1936 and 1940,
by The Singer Manufacturing Company
All Rights Reserved for all Countries

2667w

INSTRUCTIONS FOR USING AND ADJUSTING SINGER SEWING MACHINE

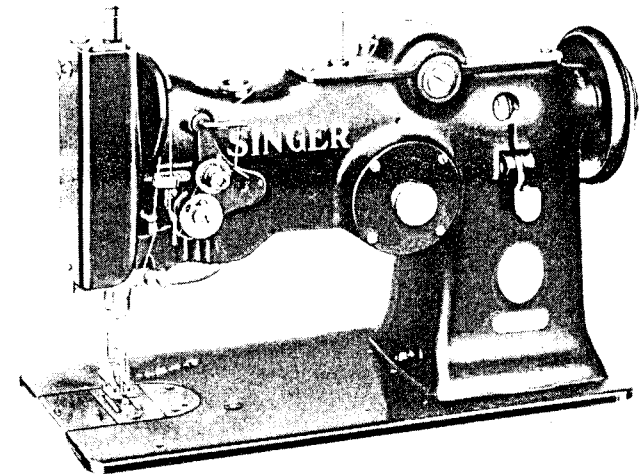

140w1

THE SINGER MANUFACTURING CO.

To Set the Needle Bar Frame

Turn the balance wheel toward you until the arrow marked "A" on needle vibrator cam (C, Fig. 26) is directly opposite the roller on the lever (D, Fig. 26). In this position, it should be possible to move the pitman stud (G, Fig. 26) upward and downward in the segment (F) without causing sidewise vibration of the needle. If this is not possible, correct by loosening screw (E) and repositioning segment (F), then retighten screw (E).

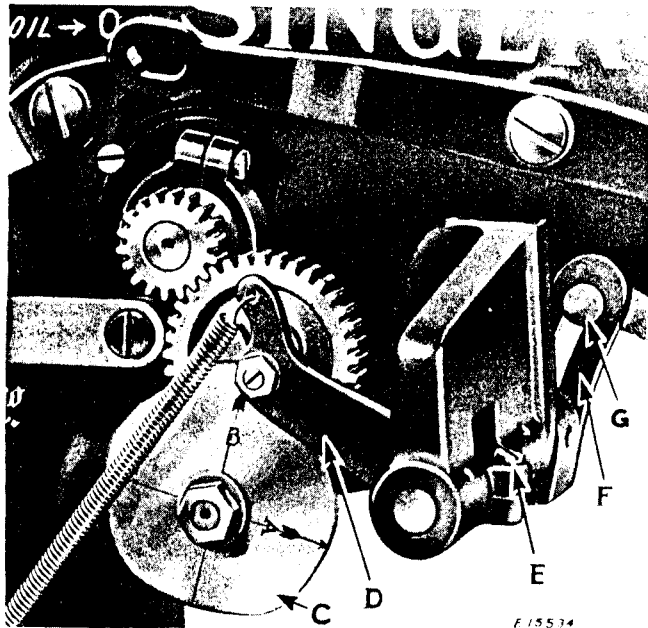

Fig. 26.

To time the needle vibrator cam (C, Fig. 26), turn the balance wheel until the timing marks J1 and K1 (Fig. 21) are together and the needle bar is at its lowest point, loosen the screws in the gear (G1, Fig. 21) and turn the cam to right or left until the arrow "B" is opposite the roller. Then retighten the screws.

If, for any reason, the intermediate gear which operates the cam (C) is thrown out of engagement with the other gears, the cam should be turned before reengagement so that after the gears are engaged, the arrow "B" will be opposite the roller with the timing marks in line as instructed above.

SPECIAL INSTRUCTIONS
COVERING
SINGER SEWING MACHINE
140w2

The instructions given in Form 2667W for Machine 140w1 apply to Machine 140w2 with the exception of those on pages 14 and 17 for regulating the width of stitch and setting the needle bar frame.

To Regulate the Width of Stitch

The bight or width of stitch is regulated by loosening the nut (A, Fig. 25) and raising or lowering the needle bar frame pitman in the segment lever as required.

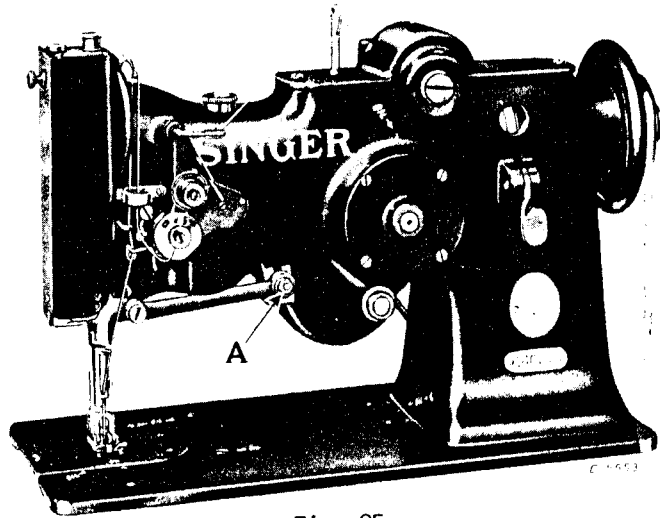

Fig. 25.

The maximum width between outside stitches is $5/16$ inch. As the width of vibration is increased, the width of the throat plate guide must also increase, in order to prevent the needle catching in the material on its two inside strokes.

THE SINGER MANUFACTURING COMPANY

Copyright U.S.A., 1941 by The Singer Manufacturing Co.
All Rights Reserved for All Countries

To all whom it may concern:

The placing or renewal of the name "Singer" (Reg. U. S. Pat. Off.) or any of the trade marks of The Singer Manufacturing Company on any machine that has been repaired, rebuilt, reconditioned, or altered in any way whatsoever outside a Singer factory or an authorized Singer agency is forbidden.

**THE IMPORTANCE OF USING
GENUINE SINGER PARTS AND NEEDLES
IN SINGER MACHINES**

The successful operation of Singer machines can only be assured if genuine Singer parts and needles are used. Supplies are available at all Singer Shops for the Manufacturing Trade and mail orders will receive prompt attention.

Genuine Singer Needles should be used
in Singer Machines.
These Needles and their Containers
are marked with the
Company's Trade Mark "SIMANCO." 1

Needles in Containers marked
"For Singer Machines"
are not Singer made needles. 2

DESCRIPTION

MACHINE 140W1 has a rotary hook and a vibrating needle and forward-and-back feeding mechanism, for fagoting and feather stitching in fabrics and light weight leather. It has ball bearings on the balance wheel end of the arm shaft and hook driving shaft, and has an aluminum alloy needle bar carrying frame.

This machine is especially valuable for open work fagoting and ornamental stitching in women's wear such as slips, brassieres, corsets, dresses and shoes. In the manufacture of table covers, scarfs, pajamas, shoes, etc., an ornamental effect can be produced by feather stitching with thread of a contrasting color.

A separator on the throat plate makes it easy to keep a uniform distance between edges being joined by fagoting. Throat plates with $3/32$, $1/8$, $5/32$ or $3/16$ inch separators can be supplied, the $5/32$ inch being standard equipment unless otherwise ordered.

For ornamental feather stitching or applique work, a throat plate without the edge guide is used.

Speed

The maximum speed recommended for Machine 140W1 is 2200 stitches per minute. The machine should be run slower than the maximum speed at first until the parts which are in movable contact have become glazed by their action upon each other. When the machine is in operation, the balance wheel should turn over towards you.

To Oil the Machine

The machine should be oiled at the places designated by un-lettered arrows in Figs. 2 to 6, and when in continuous use it should be oiled at least twice a day.

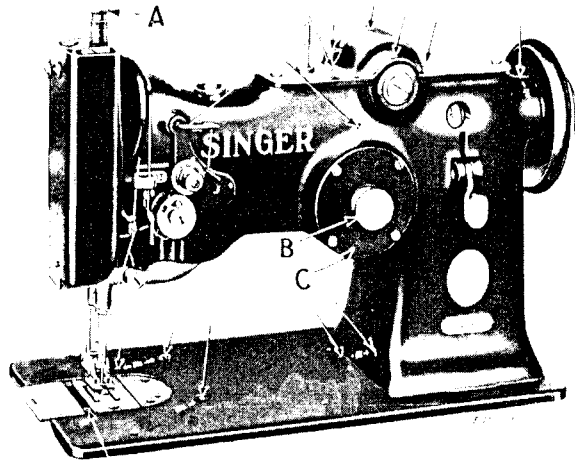

Fig. 2. Oiling Points and Adjustments at Front of Machine

Slip the belt off the balance wheel, turn the machine back on its hinges and apply oil to the points shown in Fig. 5, then bring the machine forward into place.

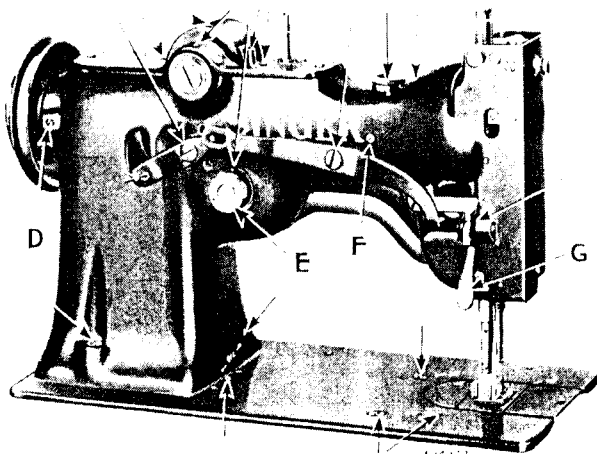

Fig. 3. Oiling Points and Adjustments at Rear of Machine

Remove the face plate and apply oil to the places indicated in Fig. 4, then replace the face plate.

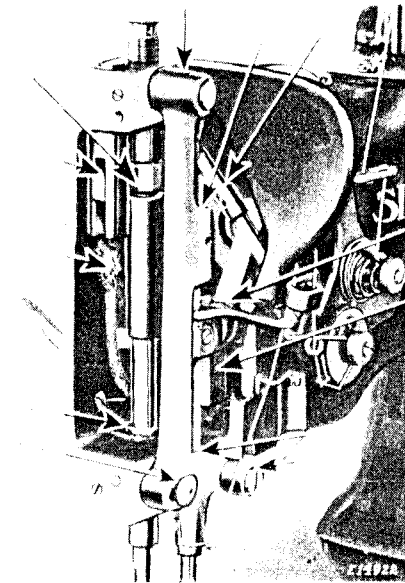

Fig. 4. Face Plate Removed, Showing Oiling Points

Oil the bobbin case bearing in the hook race each time a bobbin is replaced.

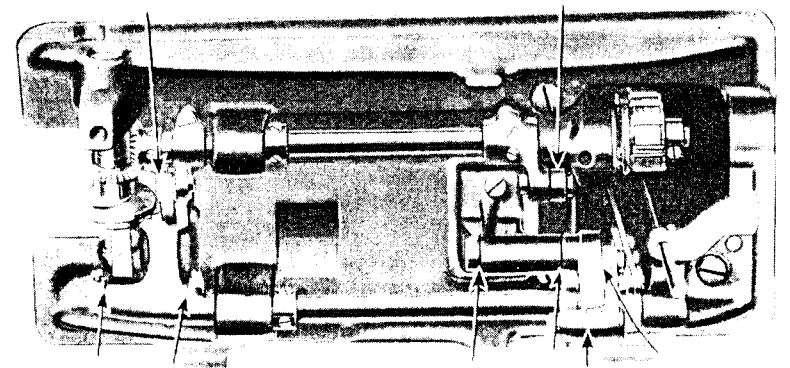

Fig. 5. Oiling Points Underneath the Machine

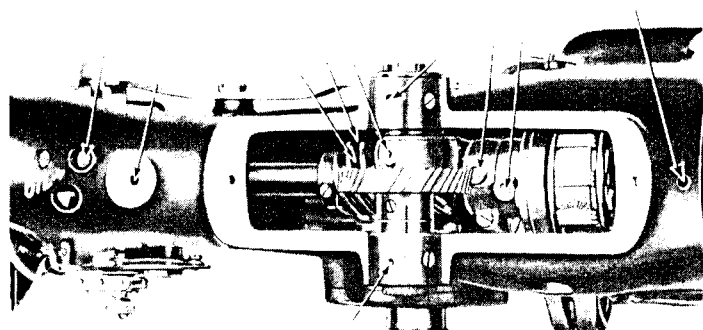

Fig. 6. Showing the Oiling Points Underneath Arm Cap

Needles

Needles for Machine 140W1 are of Class and Variety 135x7 and are made in sizes 7, 8, 9, 10, 12, 14, 16, 18, 20, 22 and 24.

The size of the needle to be used should be determined by the size of the thread which must pass freely through the eye of the needle. If rough or uneven thread is used, or if it passes with difficulty through the eye of the needle, the successful use of the machine will be interfered with.

Orders for needles must specify the QUANTITY required, the SIZE, also the CLASS and VARIETY numbers separated by x.

The following are details of an intelligible order:

"100 No. 12, 135x7 Needles."

Relative Sizes of Needles and Thread

Size Numbers of Needles	For Cloth Work	
	Cotton	Silk
12	70 to 100	00 to A
14	50 to 70	A,B
16	40 to 50	B,C
18	30 to 40	C,D
20	24 to 30	D,E

To make a smooth, even stitch with your sewing machine, use good, firmly twisted and smoothly finished thread, that passes freely through the eye of the needle. No other needles will give as good results and satisfaction as those recommended above.

In using slack twist or uneven silk, should it be frayed or roughened, see whether the needle is too fine or too sharp, or has a hooked point, made by striking the throat plate.

For ordinary work use the same size of thread on the bobbin as in the needle. Always use soft finished thread on the bobbin.

Thread

Left twist thread should be used in the needle. Either right or left twist thread can be used in the bobbin.

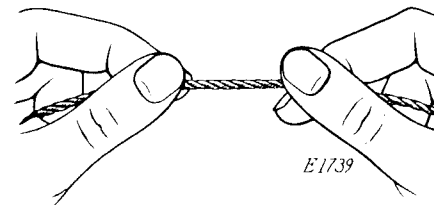

Fig. 7. How to Determine the Twist

Hold the thread as shown above. Turn the thread over toward you between the thumb and the forefinger of the right hand; if left twist, the strands will wind tighter; if right twist, the strands will unwind. Use soft finish thread of the same size for the needle and the bobbin.



Fig. 8. Removing the Bobbin Case

To Remove the Bobbin Case

Lift the bobbin case latch, as shown in Fig. 8, and draw the bobbin case out from you, turn its open end down and release the latch and the bobbin will drop out.

To Wind the Bobbin

(See Fig. 9)

Fasten the bobbin winder to the table with its driving pulley in front of the machine belt so that the pulley will drop away from the belt when sufficient thread has been wound upon the bobbin.

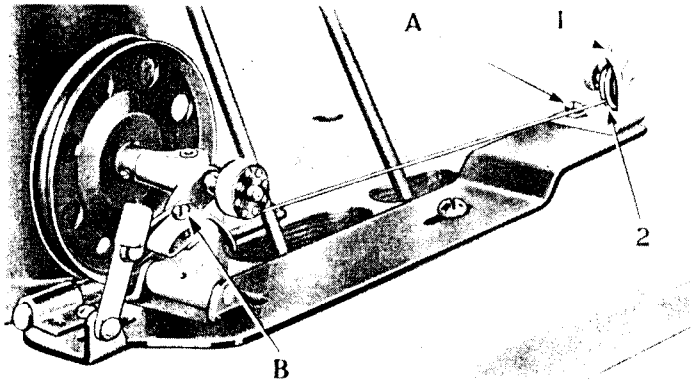

Fig. 9. Winding the Bobbin

Place the bobbin on the bobbin winder spindle and push it on as far as it will go.

Pass the thread down through the thread guide (1) in the tension bracket, around the back and between the tension discs (2). Then wind the end of the thread around the bobbin a few times, push the bobbin winder pulley over against the machine belt and start the machine.

When sufficient thread has been wound upon the bobbin, the bobbin winder will stop automatically.

If the thread does not wind evenly on the bobbin, loosen the screw (A) in the tension bracket and move the bracket to the right or left as may be required, then tighten the screw.

The amount of thread wound on the bobbin is regulated by the screw (B). To wind more thread on the bobbin, turn the screw (B) inwardly. To wind less thread on the bobbin, turn the screw outwardly.

Bobbins can be wound while the machine is stitching.

To Thread the Bobbin Case

Hold the bobbin between the thumb and forefinger of the right hand, the thread drawing on the bottom from the left toward the right, as shown in Fig. 10.

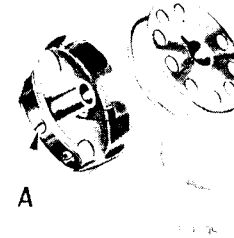

Fig. 10

With the left hand, hold the bobbin case as shown in Fig. 10, the tension spring being at the front and place the bobbin into the bobbin case.

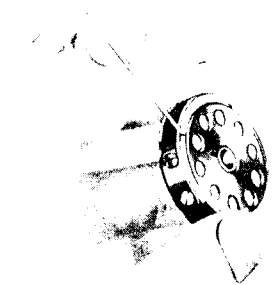

Fig. 11

Then pull the thread into the slot in the edge of the bobbin case as shown in Fig. 11, and back under the tension spring into the slot at the end of the tension spring, as shown in Fig. 12.

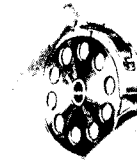

Fig. 12

To Replace the Bobbin Case

After threading, take the bobbin case by the latch, holding it between the thumb and forefinger of the left hand; place the bobbin case on the center stud of the bobbin case base, release the latch and press the bobbin case back until the latch catches the groove near the end of the stud. Allow the thread to hang free and replace the slide in the bed of the machine.

To Set the Needle

Push the needle up in the needle bar as far as it will go, with the long groove to the front, and secure it firmly with the set screw.

It may be necessary to turn the needle slightly to the right or left for some threads, if stitches are missed.

Operators are liable to use needles which are too fine. Better results usually follow the use of a needle of a larger size.

Threading the Needle

(See Fig. 13)

Turn the balance wheel until the thread take-up (12) is at its highest point.

Pass the thread from the unwinder, from back to front through the lower hole (1) in the pin on top of the machine, from right to left through the upper hole (2) in the pin, downward through the left-hand hole (3), upward through the middle hole (4) and downward through the right-hand hole (5) of the thread straightener, down under the guide (6), over to the left between the tension discs (7), around beneath the thread controller (8) and against the pressure of the controller spring into the fork at (9), under the wire guard (10), up through the thread guide (11), from right to left through the thread take-up eyelet (12), down again through the guide (11), through the eyelet in the auxiliary thread take-up (13), back of the guide (14), through guide (15), down through the hole (16) at the lower end of the needle bar, and from front to back through the eye of the needle (17). Draw about two inches of thread through the eye of the needle with which to commence sewing.

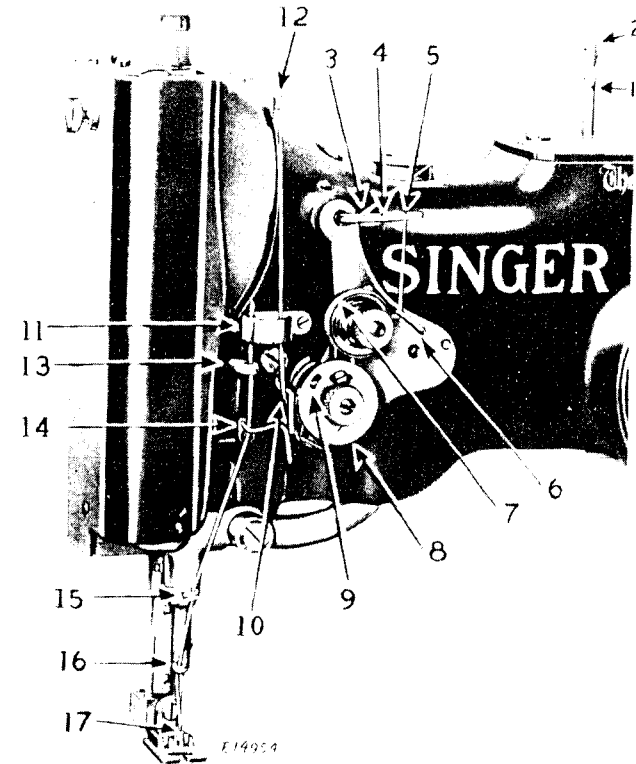

Fig. 13. Threading the Needle

To Prepare for Sewing

With the left hand hold the end of the needle thread, leaving it slack from the hand to the needle, turn the balance wheel over toward you until the needle moves down and up again to its highest point, thus catching the bobbin thread; draw up the needle thread and the bobbin thread will come up with it through the hole in the throat plate. Lay both threads back under the presser foot.

To Commence Sewing

Place the material beneath the presser foot, lower the presser foot and commence to sew, turning the balance wheel over toward you.

To Turn a Corner

Stop the machine while the needle is rising, but before it is out of the material, raise the presser foot and turn the work, using the needle as a pivot.

To Remove the Work

Raise the presser lifter, turn the machine by the balance wheel until the take-up lever (12, Fig. 13) is at its highest point and draw the work from you. If the threads do not draw out easily, the take-up lever is not in the right position, as directed. If the machine is stopped as directed, the needle will not be unthreaded in starting to sew, even if only a short end is left through the needle.

For convenience in taking out the work, the tension of the upper thread is released by raising the presser foot with the lifter (G, Fig. 3); but is not released by thick goods or seams passing under the presser foot. Do not try to adjust the upper tension (M, Fig. 18) when the presser lifter is up as the tension is then loose.

Causes of the machine not working properly will usually be found in the tension not being correctly adjusted, or its discs may be clogged with lint or knots of thread or the thread controller spring (L, Fig. 18) may not have the correct tension (this is important); the thread may be too coarse or too fine for the needle, or the needle and thread too coarse or too fine for the throat plate, or the needle bent or blunt. See that a straight needle is pushed up in the needle bar as far as it should go; any particle of lint or dirt which prevents it from going up can be removed through the cross hole in the needle bar.

To Regulate the Pressure on the Material

The pressure of the presser foot on the material may be increased by turning down the thumb screw (A, Fig. 2) above the presser bar, or decreased by turning this thumb screw upward.

Tensions

The needle and bobbin threads should be locked in the center of the thickness of the material, thus:



Fig. 14. Perfect Stitch

If the tension on the needle thread is too tight, or if that on the bobbin thread is too loose, the needle thread will lie straight along the upper surface of the material, thus:



Fig. 15. Tight Needle Thread Tension

If the tension on the bobbin thread is too tight, or if that on the needle thread is too loose, the bobbin thread will lie straight along the under side of the material, thus:



Fig. 16. Loose Needle Thread Tension

To Regulate the Tensions

THE TENSION ON THE NEEDLE THREAD SHOULD ONLY BE REGULATED WHEN THE PRESSER FOOT IS DOWN. Having lowered the presser foot, turn the thumb nut (M, Fig. 18) at the front of the tension discs over to the right to increase the tension. To decrease the tension, turn this thumb nut over to the left.

The tension on the bobbin thread is regulated by the screw (A, Fig. 10) in the tension spring on the outside of the bobbin case. To increase the tension, turn this screw over to the right. To decrease the tension, turn this screw over to the left.

When the tension on the bobbin thread has been once properly adjusted, it is seldom necessary to change it, as a correct stitch can usually be obtained by varying the tension on the needle thread.

To Regulate the Distance between Stitches

The distance between stitches depends on the amount of forward-and-backward feeding motion, and is indicated by a number appearing in the opening shown below.

Press the stitch regulator lever (A, Fig. 17) and at the same time turn the balance wheel over toward you until the lever (A)

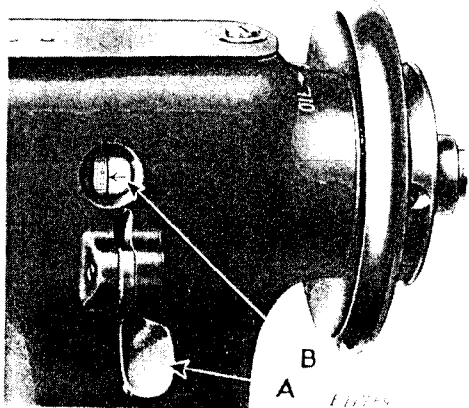

Fig. 17. Stitch Regulator

engages the notch in the stitch regulator flange (B, Fig. 17). Continue to hold the lever (A) in the notch in the flange (B) and at the same time turn the balance wheel backward or forward, as required, until the desired number is opposite the arrow, as shown in Fig. 17, then release the lever (A).

To Regulate the Width of Stitch

The bight or width of stitch is regulated by means of the needle vibrator regulating spindle head (B, Fig. 2) at the front of the machine. To increase the width of stitch, turn the regulating spindle head over to the left. To decrease the width of stitch, turn the spindle head over to the right. The extreme width of stitch is $\frac{3}{16}$ inch. For fagoting, the stitch width will depend on the distance between edges being joined.

The distance between edges being fagoted is controlled by the size of the guide on the throat plate. Throat plates are available for openings of $\frac{3}{32}$, $\frac{1}{8}$, $\frac{5}{32}$ and $\frac{3}{16}$ inch.

INSTRUCTIONS FOR ADJUSTERS AND MACHINISTS

Thread Controller

The function of the thread controller spring is to hold back the slack of the needle thread until the eye of the needle nearly reaches the goods in its descent, as without this controlling action of the spring, the slack thread or silk (more especially silk) will sometimes be penetrated by the point of the needle as the needle is descending.

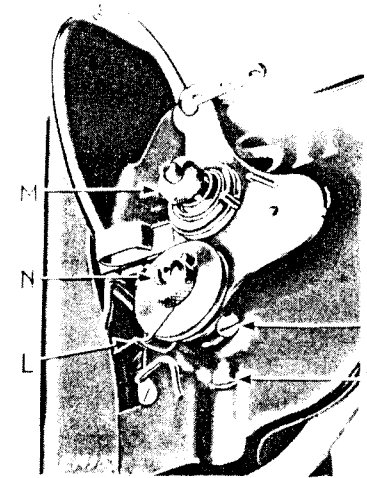

Fig. 18

For more controller action on the thread, loosen the stop screw (O, Fig. 18) under the controller discs, and set the stop lower. For less action, set the stop higher. The position of the controller spring (L) shown in Fig. 18 is the best average setting for stitching fine fabrics and light leathers.

To strengthen the action of the controller spring on the thread, loosen the tension stud screw (P, Fig. 18), and turn the tension stud (N) slightly to the left with a screwdriver. To lighten the spring action, turn the stud to the right, then tighten the tension stud screw (P).

To Time the Sewing Hook

Remove the throat plate and turn the balance wheel over toward you until the LOWER timing mark (V, Fig. 20) on the needle bar is just visible at the end of the needle bar frame (or until the needle has risen $\frac{3}{32}$ inch from its lowest position); if the needle and hook are in correct time, the point of the hook will be opposite the center of the needle.

To time the hook, loosen the set screws in the lower belt pulley (R1, Fig. 22) and turn the hook as required. Before tightening the set screws, see that there is no end play in the shaft.

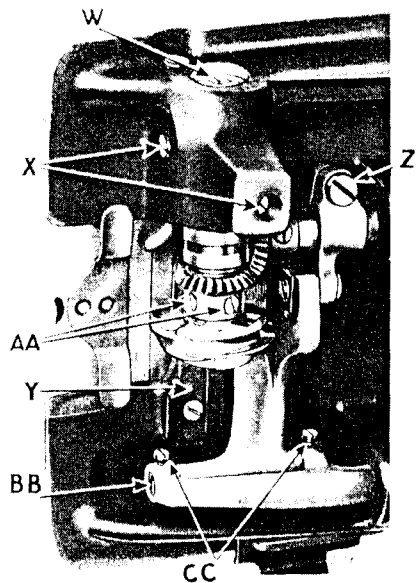

Fig. 19

To Set the Hook To or From the Needle

The point of the hook should come as close as possible to the needle without touching it. Loosen the four screws (X and AA, Fig. 19) and slide the hook to the correct position, then tighten the two screws (X). Reset the gear on the hook shaft and tighten screws (AA).

To Remove the Hook

Remove the bobbin case stop (Y, Fig. 19), loosen the hook spindle screw (W, Fig. 19) a few turns and tap it lightly to loosen the hook. Then remove the screw (W) and withdraw the hook from its socket.

To Set the Needle Bar Frame

First turn the needle vibrator regulating spindle head (B, Fig. 2) at the front of the machine to hold the needle bar frame

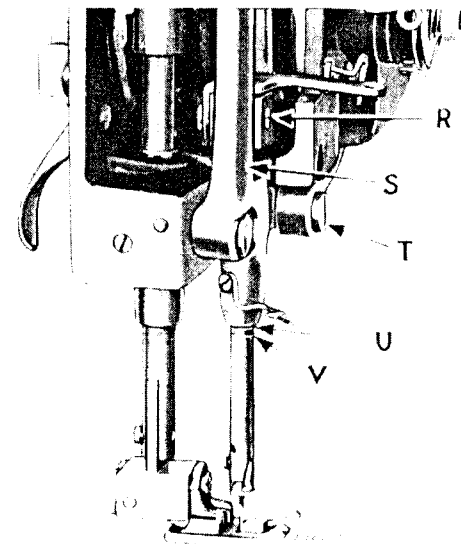

Fig. 20. Face Plate Removed

(S, Fig. 20) stationary (no side movement). A straight needle should now come in the center of the needle hole in the throat plate. If it does not, loosen the set screw which holds eccentric stud (T, Fig. 20) and adjust the stud (T) until it does.

Now turn the needle vibrator regulating spindle head for the widest throw, and turn the balance wheel until the needle bar frame is at its extreme sidewise throw. The frame (S) should commence its sidewise movement at the same time that the needle starts upward from its lowest position. If it does not, the movement of the needle bar frame may be timed by turning the vibrator gear pinion (G1, Fig. 21) on the shaft.

To Set the Needle Bar

See that the needle is up in the bar as far as it will go. There are two lines $\frac{3}{32}$ inch apart across the needle bar, about two inches above the lower end. When the needle bar is at its lowest position, the upper mark (U, Fig. 20) should be just visible at the lower end of the needle bar frame.

In case the needle bar is not correctly set, loosen the needle bar connecting stud set screw (R, Fig. 20) and move the needle bar to the correct position, then tighten the set screw.

TO SET A NEEDLE BAR WHICH HAS NO MARK: Set the needle bar so that when it rises $\frac{3}{32}$ inch from its lowest position, the eye of the needle will be about $\frac{1}{16}$ inch below the point of the hook as the hook point enters the thread loop.

Feed Mechanism

To take up lost motion of the feed driving and lifting connections, adjust their pinch screws (N1, Fig. 21).

To prevent the feed dog from striking either end of the slots in the throat plate, loosen screw (U1, Fig. 22) and move the feed dog forward or backward until the longest stitch can be taken without the feed dog striking, then tighten the screw (U1).

To Raise or Lower the Feed Dog

Usually when at its highest position, the feed dog should show a full tooth above the throat plate.

Remove the throat plate; clean the lint and dirt from between the feed points and replace the throat plate; tip the machine back and turn the balance wheel toward you until the feed dog is at its highest position; loosen screw (Z, Fig. 19) and raise or lower the feed dog as required, then tighten the screw (Z).

Loosen the two screws (CC, Fig. 19) and turn the eccentric stud (BB, Fig. 19) to level off the front and back of the feed dog, then tighten the screws (CC).

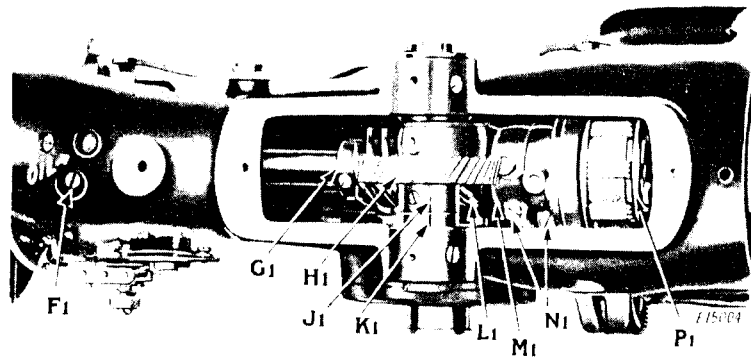

Fig. 21. Arm Cap Removed

To Time the Feed Reversing Eccentric

Remove arm cap from top of machine. Turn the balance wheel over toward you until the needle bar frame (S, Fig. 20) is at its extreme left throw and the needle bar at its lowest position. The timing mark (J1, Fig. 21), on the hub of the gear (H1), should now be in line with the timing mark (K1) on the end of the bushing. If the two timing marks are not in line, loosen the screws in spiral pinion (L1, Fig. 21) on the arm shaft and turn pinion (L1) to right or left to bring them in line, then tighten the screws in the pinion.

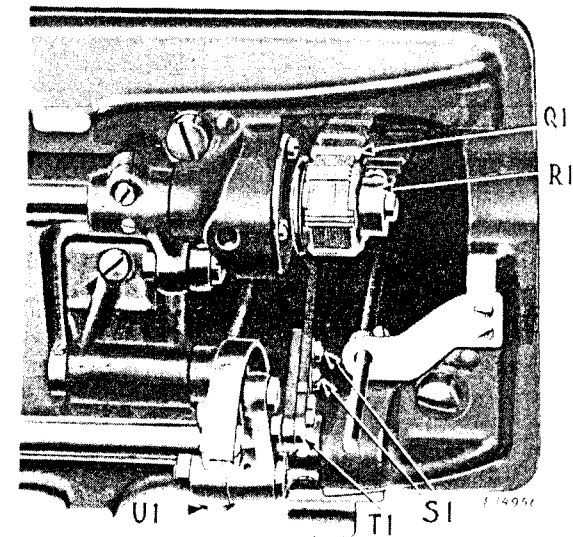

Fig. 22. Return Feed Adjustment
To Adjust for Amount of Return Feed

After the stitch is made in the edge of the material at the maximum side throw of the needle, the material must be fed backward far enough on the next stitch so that the needle passes behind the last stitch to form the fagoting lock instead of an ordinary zigzag stitch.

Turn the balance wheel over toward you until feed control connection (T1, Fig. 22) is at its lowest position; loosen screws (S1) and lengthen connection to get more return feed or shorten the connection for less return feed, then tighten the screws (S1).

To Remove the Needle Vibrator Gear Shaft

Remove the needle vibrator regulating spindle head (B, Fig. 2) and the eccentric bracket cover (C, Fig. 2); remove the locking and adjusting screws (A1 and B1, Fig. 23), also the screw and spring (E1). Loosen the two set screws in the gear (D1) and remove the needle vibrator gear shaft collar (E, Fig. 3) at the back of the arm, then draw the shaft out.

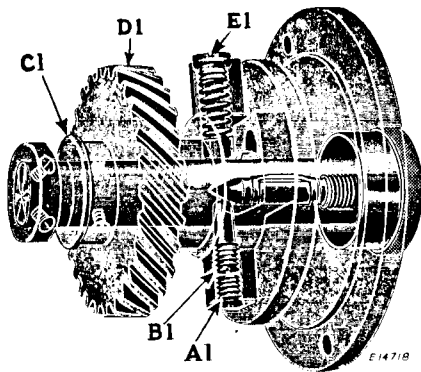

Fig. 23. Transparent view showing the needle vibrator regulating spindle head at front of machine

When replacing these parts be careful that the large washer (C1, Fig. 23) is in place between the gear and arm, that the position screws are set firmly against the flat spots on the shaft and that the set screws are at the right of the position screws when the shaft has been returned to its place.

To Remove the Arm Shaft

Slide the arm shaft connection belt (Q1, Fig. 22) off the lower pulley and lift it off the upper belt pulley (P1, Fig. 21). Loosen the set screws and remove the spot screws in the pulley (P1), the feed lifting eccentric (M1, Fig. 21), and the needle bar crank (F1). Loosen the screws in the gear pinion (L1) and the worm gear (G1), then draw the shaft out from the balance wheel end.

To Remove the Belt from Within the Arm

Slide the arm shaft connection belt (Q1, Fig. 22) off the lower pulley, and remove the balance wheel; loosen the arm shaft ball bearing bushing (back) set screw (D, Fig. 3) at the back of the arm, and remove the bushing; lift the belt up through the arm cap hole as far as possible and draw it out through the space formerly occupied by the bushing.

When replacing the belt see that the sewing hook and needle are in correct time before running the belt on the lower pulley and verify the correctness of the timing before commencing to sew.

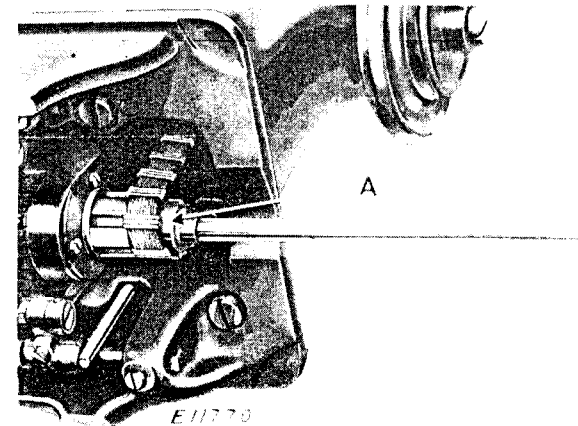

Fig. 24. Putting Belt on Lower Pulley with Belt Replacer 244005

To facilitate the replacing of the belt on the lower pulley, use belt replacer 244005 (A, Fig. 24). Rest the replacer in the loop of the belt and slide it over the hub of the pulley, as shown in Fig. 24, having the notches in the replacer engage the two set screws in the hub of the pulley. Turn the balance wheel toward you until the belt is fully over the pulley, then remove the replacer.

NOTE: As belt replacer 244005 will serve for several machines, it is not regularly furnished with the machine, and must be ordered separately.