

SINGER

153K101, K102, K103 AND 154K101

USE SINGER* OILS and LUBRICANTS

They insure freedom from lubricating trouble and give longer life to sewing equipment

The following are the correct lubricants for this machine:

TYPE B — MANUFACTURING MACHINE OIL, HEAVY GRADE

When an oil is desired which will produce a minimum of stain on fabrics, even after a long period of storage, use:

TYPE D — MANUFACTURING MACHINE OIL, HEAVY GRADE

OTHER SINGER* LUBRICANTS

TYPE E — THREAD LUBRICANT

For lubricating the needle thread of sewing machines for stitching fabrics or leather where a thread lubricant is required.

TYPE F — MOTOR OIL

For oil lubricated motors and plain bearings in power tables and transmitters.

NOTE: All of the above oils are available in 1 quart, 1 gallon and 5 gallon cans.

GEAR LUBRICANT

This specially prepared grease is recommended for gear lubrication on manufacturing sewing machines.

BALL BEARING LUBRICANT

This pure grease is specially designed for the lubrication of ball bearings and ball thrust bearings of motors and electric transmitters, ball bearing hangers of power tables, etc. Furnished in 1 lb. and 4 lb. tins.

Form K6435
(165)

INSTRUCTIONS

FOR USING AND ADJUSTING

SINGER*

SEWING MACHINES

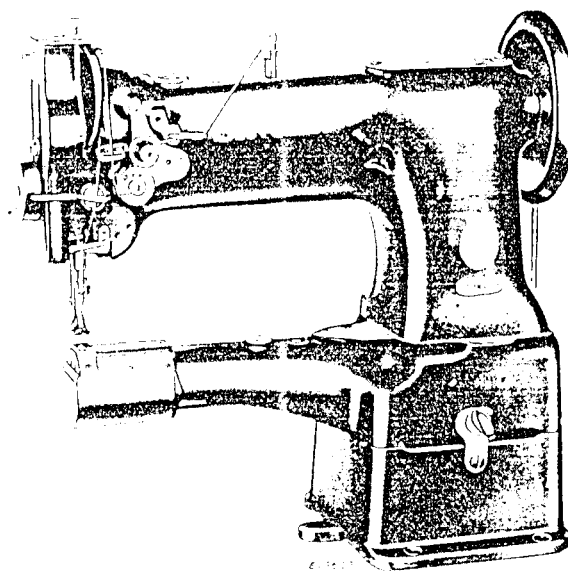

**153K101, 153K102, 153K103
and 154K101**

CYLINDER BED

COMPOUND FEED

HIGH SPEED

THE SINGER COMPANY

DESCRIPTION

These lock stitch, cylinder machines have a compound feed, belt-driven rotary sewing hook on a vertical axis and a safety clutch which protects the hook from damage.

Machine 153K101 has one needle and one hook and has alternating pressers in addition to the compound feed. This is the heavy duty machine in the 153K class for all work requiring a strong feed mechanism such as leather garments and cushion closing operations.

Machine 153K102 has one needle and one hook and has a four-motion under-feed mechanism as part of its compound feed. This machine is used for stitching light and medium weight cloth and leather.

Machine 153K103 is the same as Machine 153K102 except that it has alternating pressers in addition to the compound feed. This machine is used for stitching light and medium weight cloth and leather.

MACHINE 154K101 has two needles and two hooks, otherwise it is the same as Machine 153K102. It is furnished in gauges from 1/8 to 1/2 inch, as ordered.

Speed

The maximum speed recommended for Machines 153K102 and 154K101 is 3000 R.P.M., and for Machines 153K101 and 153K103 the maximum speed is 2900 R.P.M., depending on the nature of the material being stitched. The machine should be run slower than the maximum speed until the parts which are in movable contact have become glazed by their action upon each other. When the machine is in operation, the machine pulley should always turn over toward the operator.

Needles

Needles for Machines 153K102 and 154K101 are Catalogue 1901 (135x7) which are made in sizes 12, 14, 16, 18, 20, 22 and 24.

Needles for Machines 153K101 and 153K103 are Catalogue 3370 (135x16) which are made in sizes 14, 15, 16, 17, 18, 19, 20, 21, 22, 23 and 24.

The size of the needle to be used should be determined by the size of the thread which must pass freely through the eye of the needle. If rough or uneven thread is used, or if it passes with difficulty through the eye of the needle, the successful use of the machine will be interfered with.

Orders for needles must specify the QUANTITY required, the SIZE number, and also the CATALOGUE number.

The following is an example of an intelligible order:

"100 size 18, Catalogue 1901 Needles"

The best stitching results will be obtained with needles sold by Singer Sewing Machine Company.

Oiling the Machines

When the machine is received from the factory it should be thoroughly cleaned and oiled. When the machine is in continuous use it should be oiled at least twice a day. Use "TYPE B" or "TYPE D" OIL sold by Singer Sewing Machine Company.

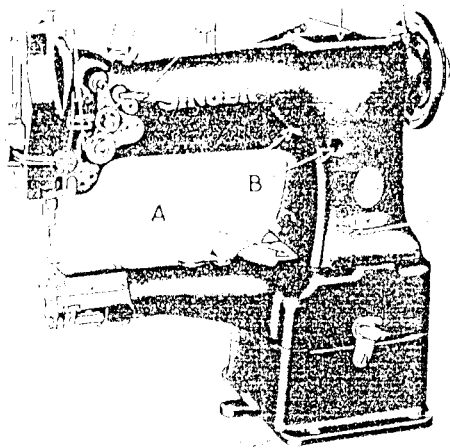

Fig. 2. Oiling Points at the Front of the Machine

Oil should be applied to each of the places designated by arrows in Figs. 2 to 5A.

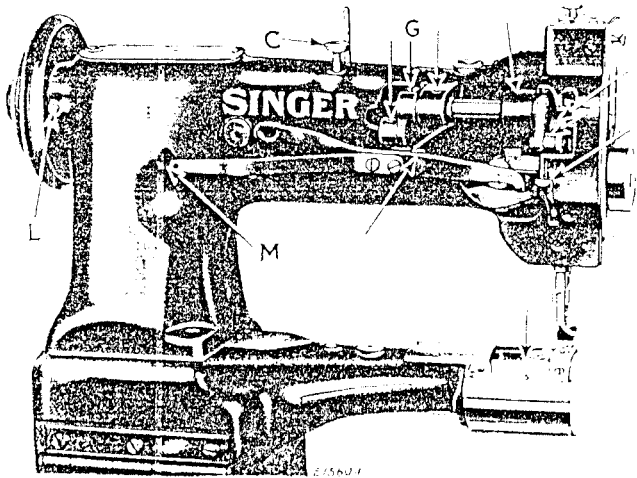

Fig. 3. Oiling Points and Adjustments at Back of Machine 153K103

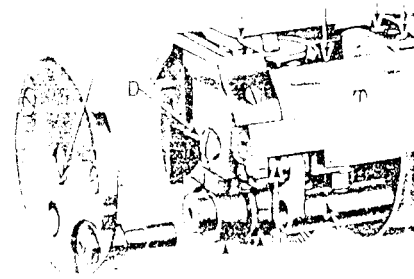

Fig. 4 Oiling Points and Adjustment in End of Cylinder

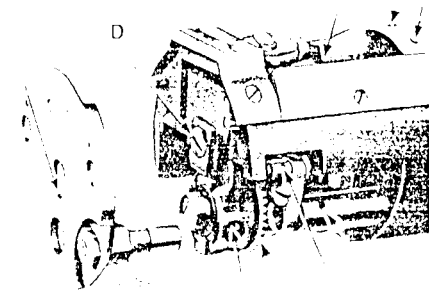

Fig. 4A Oiling Points and Adjustments in End of Cylinder Machine 153K101 only

Remove the cylinder end cover and apply oil to the places indicated in Fig. 4. Move the face plate aside and oil the wick and bearings shown in Fig. 5, then replace the face plate.

The small felt pad on the side of the bobbin case should be kept wet with oil to lubricate the hook race.

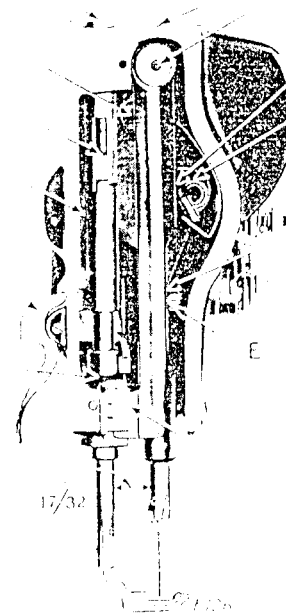

Fig. 5. Machine 153K102 and 154K101

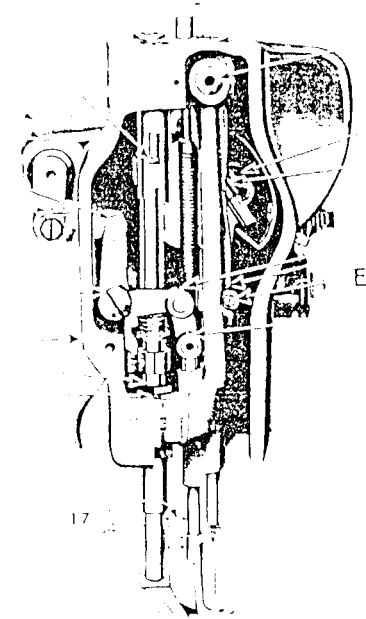

Fig. 5A. Machine 153K101 and 153K103

Oiling Points and Adjustments Back of the Face Plate

Relative Sizes of Needles and Thread

The following sizes of needles and thread are recommended:

SIZES OF NEEDLES	COTTON THREAD	SILK THREAD
9, 10	70	00 and 0
11	60	A
12	50	B
13	40	C
14	36	D
15	30	D
16	30	E
18	24	EE
20	20	
22	16	
23	12	
24, 25	8	

Thread

Use left twist thread for the needle. Either left or right twist thread may be used for the bobbin.

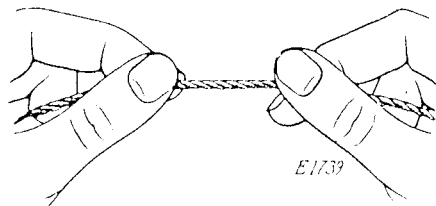

Fig. 6. How to Determine the Twist

Hold the thread as shown above. Turn the thread over toward you between the thumb and the forefinger of the right hand; if left twist, the strands will wind tighter; if right twist the strands will unwind.

To Set the Needle

Turn the machine pulley over toward you until the needle bar moves up to its highest point; loosen the set screw in the needle bar and put the needle up into the bar as far as it will go, with its long groove toward the left, the eye of the needle being directly in line with the machine bed, then tighten the set screw.

ON MACHINE 154K101, the needles should be set with their long grooves facing each other and the eyes in line.

To Remove the Bobbin

Draw out the slide plate in the bed of the machine, and on Machine 154W101, also remove the cylinder bed cap. Insert the finger nail of the forefinger under the latch (G, Fig. 9) of each bobbin case, raise the latch and remove the bobbin.

To Wind the Bobbin

Fasten the bobbin winder to the table with its driving pulley in front of the machine belt, so that the pulley will drop away from the belt when sufficient thread has been wound upon the bobbin.

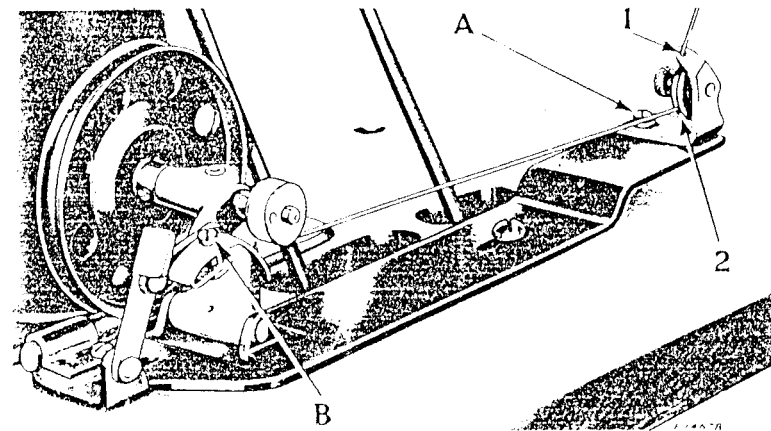

Fig. 7. Winding the Bobbin

Place the bobbin on the bobbin winder spindle and push it on as far as it will go.

Pass the thread down through the thread guide (1) in the tension bracket, around the back and between the tension discs (2). Then wind the end of the thread around the bobbin a few times, push the bobbin winder pulley over against the machine belt and start the machine.

When sufficient thread has been wound upon the bobbin, the bobbin winder will stop automatically.

If the thread does not wind evenly on the bobbin, loosen the screw (A) in the tension bracket and move the bracket to the right or left as may be required, then tighten the screw.

The amount of thread wound on the bobbin is regulated by the screw (B). To wind more thread on the bobbin, turn the screw inwardly. To wind less thread on the bobbin, turn the screw outwardly.

Bobbins can be wound while the machine is stitching.

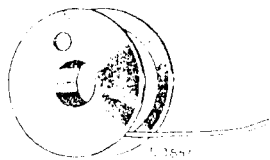

Fig. 8. Direction of Thread on Bobbin

To Replace the Bobbin and Thread the Bobbin Case

The following instructions apply to both bobbins in Machine 154K101.

Hold the bobbin between the thumb and forefinger of the right hand, the thread drawing on the bottom from the left toward the right (see Fig. 8), and place it on the centre stud of the bobbin case, then push down the latch as shown in Fig. 9. Draw the thread into the slot (1, Fig. 9) and back of the projection (2, Fig. 9), leaving a loose end of thread about two inches long above the slide. When closing the slide, leave just enough space for the thread to pass through.

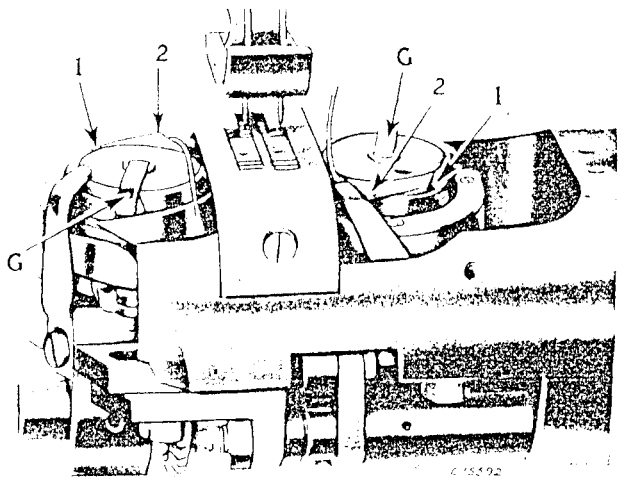

Fig. 9. Bobbin Cases of Machine 154K101 Threaded

The bobbin case in Machines of Class 153K is threaded the same as the right hand bobbin case illustrated above.

Upper Threading

MACHINES 153K101, 153K102 AND 153K103. Pass the thread from the unwinder from back to front through the lower hole (1) in the pin on top of the machine and from right to left through

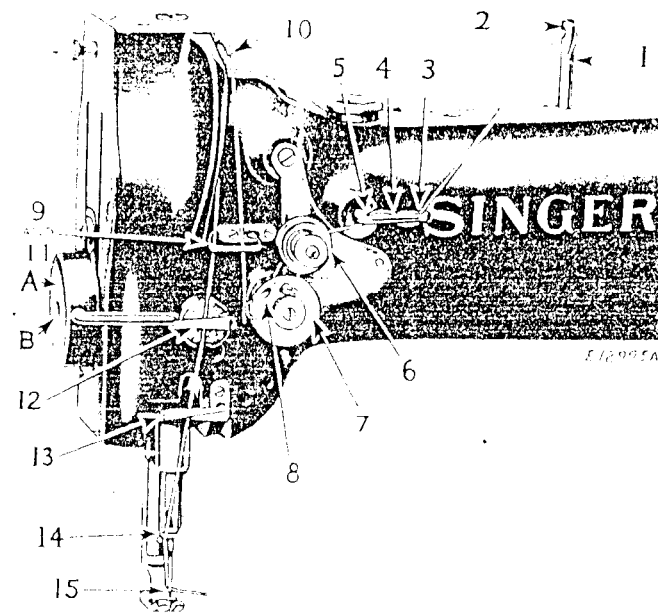

Fig. 10. Threading Class 153K Machines

the upper hole (2) in the pin, down through the hole (3), up through the hole (4) and down through the hole (5) in the thread guide at the front of the machine, over from right to left between the tension discs (6), down, under from right to left around the thread controller (7), up into the take-up spring (8) and against the pressure of the spring until the thread enters the fork in the thread controller disc; up through the thread guide (9), from right to left through the hole (10) in the thread take-up lever, down through the thread guides (11, 12 and 13), through the guide (14) at the bottom of the needle bar, and from left to right through the eye of the needle (15).

Upper Threading of Machine 154K101

TO THREAD THE OUTSIDE NEEDLE OR THE ONE FARTHEST FROM THE UPRIGHT PART OF THE ARM, pass the thread from the unwinder from

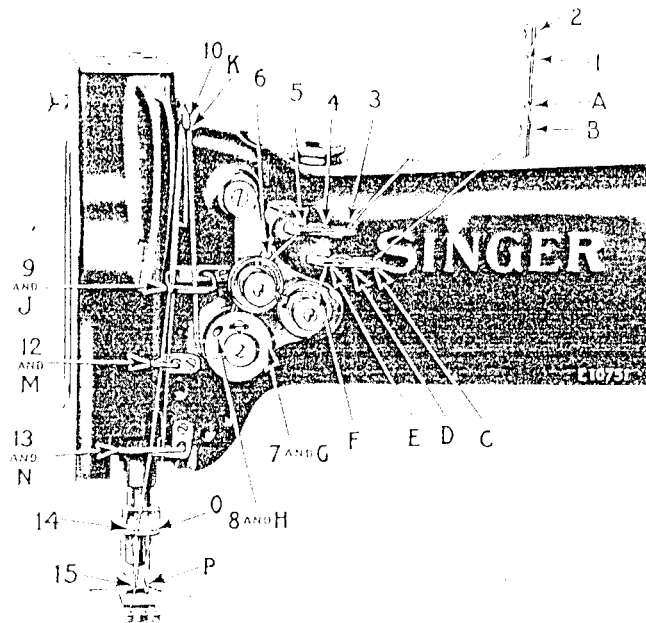

Fig.11. Upper Threading of Machine 154K101

back to front through the hole (1) in the pin on top of the machine, then from right to left through the hole (2) in the pin, down through the hole (3), up through the hole (4) and down through the hole (5) in the thread guide at the front of the machine, over from right to left between the left tension discs (6), down under from right to left around the thread controller (7), up into the fork (8) of the thread controller against the pressure of the wire controller spring, up through the thread guide (9), up and from right to left through the upper hole (10) in the end of the thread take-up lever, down through the thread guide (9) again, and through the thread guides (12 and 13), down through the left hole (14) in the needle holder and from right to left through the eye of the left or outside needle (15).

TO THREAD THE INSIDE NEEDLE OR THE ONE NEAREST THE UPRIGHT PART OF THE ARM, pass the thread from the unwinder from back to front through the hole (A) in the pin on top of the machine, then from right to left through the hole (B) in the pin, down through the hole (C), up through the hole (D) and down through the hole (E) in the thread guide at the front of the machine, under from right to left between the right tension discs (F), down under from right to left around the thread controller (G), up into the fork (H) of the thread controller against the pressure of the wire controller spring, up through the thread guide (J), up and from right to left through the lower hole (K) in the end of the thread take-up lever, down through the thread guide (J) again, and through the thread guides (M and N), down through the right hole (O) in the needle holder and from left to right through the eye of the right or inside needle (P).

Draw about three inches of thread through the eye of each needle with which to commence sewing.

To Prepare for Sewing

With the left hand hold the end of the needle thread, leaving it slack from the hand to the needle. Turn the machine pulley over toward you until the needle moves down and up again to its highest point, thus catching the bobbin thread; draw up the needle thread and the bobbin thread will come up with it through the hole in the feed dog. Lay the threads back under the presser foot and close the slide.

To Commence Sewing

Place the material beneath the presser foot, lower the presser foot and commence to sew, turning the machine pulley over toward you.

To Remove the Work

Have the thread take-up lever at the highest point, raise the presser foot, draw the work back and cut the threads close to the goods. Lay the ends of the threads back under the presser foot.

Tensions

The needle and bobbin threads should be locked in the centre of the thickness of the material, thus:



Fig.12. Perfect Stitch

If the tension on the needle thread is too tight, or if that on the bobbin thread is too loose, the needle thread will lie straight along the upper surface of the material, thus:



Fig.13. Tight Needle Thread Tension

If the tension on the bobbin thread is too tight, or if that on the needle thread is too loose, the bobbin thread will lie straight along the under side of the material, thus:

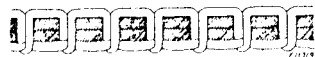

Fig.14. Loose Needle Thread Tension

To Regulate the Tensions:

The tension on the needle thread is regulated by the thumb nut (R, Fig.16) at the front of the tension discs on the front of the machine. To increase the tension, turn this thumb nut over to the right. To decrease the tension, turn this thumb nut over to the left.

The tension on the bobbin thread is regulated by means of the screw nearest the centre of the tension spring on the outside of the bobbin case. To increase the tension, turn this screw over to the right. To decrease the tension, turn this screw over to the left.

To Regulate the Pressure on Material

The pressure on the material is regulated by the screw (C, Fig. 3) at the back of the machine, the screw acting on a flat spring. To increase the pressure, turn this screw downward. To decrease the pressure, turn this screw upward. The pressure should be only heavy enough to enable the feed to move the work along evenly.

To Regulate the Length of Stitch

The length of stitch is regulated by the thumb screw (A, Fig. 15) at the right of the machine pulley.

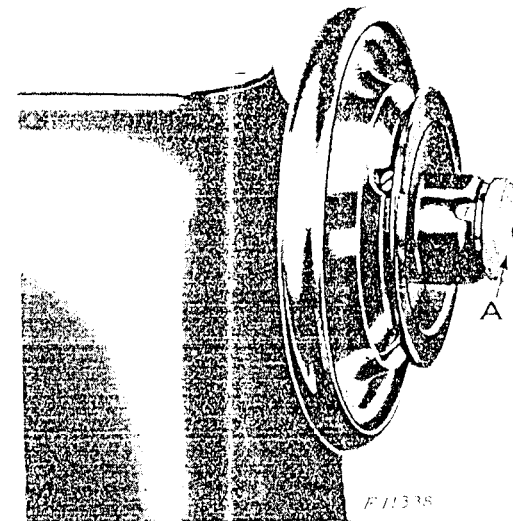

Fig. 15. Stitch Regulator

There is a notch in the hub of the machine pulley, as shown in Fig.15, and the number appearing in the notch shows the approximate number of stitches to the inch that the machine is ready to make.

To lengthen the stitch, turn the thumb screw (A) over toward you. To shorten the stitch, turn this thumb screw over from you.

To Adjust the Thread Lubricator for Stitching Leather

To ensure satisfactory results, "TYPE E" Thread Lubricant, sold only by Singer Sewing Machine Company, should be used in the thread lubricator which is attached to the face plate.

When replenishing the lubricant supply, fill the reservoir (A, Fig.10) to about 1/8 inch below the filler hole (B, Fig.10).

The amount of lubrication of the thread is controlled by raising or lowering the felt pad holder (12, Fig.10) above or below the level of the lubricant. For more lubricant, lower the felt pad holder. For less lubricant, raise the felt pad holder.

INSTRUCTIONS FOR ADJUSTERS AND MACHINISTS

Thread Controller

The function of the thread controller spring is to hold back the slack of the needle thread until the eye of the needle nearly reaches the goods in its descent, as without this controlling action of the spring, the slack thread or silk (more especially silk) will sometimes be penetrated by the point of the needle as the needle is descending.

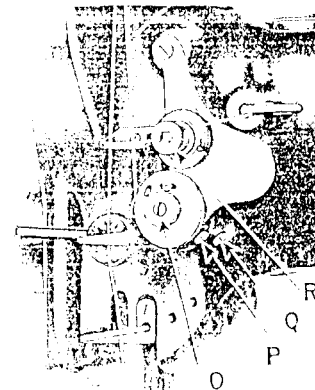

Fig. 16. Adjustment of Thread Controller

For more controller action on the thread, loosen the stop screw (P, Fig. 16) at the right of the tension and set the stop lower, and for less action set the stop higher.

To strengthen the action of the controller spring on the thread, loosen the tension stud screw (Q, Fig. 16) at the right of the stop screw and turn the tension stud (O, Fig. 16) slightly to the left with a screwdriver, or to lighten its action turn to the right and retighten the tension stud screw.

To Set the Needle Bar

See that the needle is up in the bar as far as it will go. There are two lines across the needle bar about two inches above the lower end. When the needle bar is at its lowest position, the upper mark should be just visible at the end of the needle bar frame.

In case the needle bar is not correctly set, loosen the needle bar connecting stud pinch screw (E, Fig. 5) and place the needle bar in correct position as directed above, then retighten the screw (E).

TO SET A NEEDLE BAR WHICH HAS NO MARK. Set the stitch regulator to indicate 9 stitches to the inch, then set the needle bar so that when it rises $3/32$ inch from its lowest position, the point of the sewing hook will be at the centre of the needle and about $1/16$ inch above the eye.

Relative Positions of Needle Bar and Presser Bar

(Machines 153K102 and 154K101)

The distance between the needle bar and presser bar, after turning the stitch regulator so that there is no feed movement, should be $17/32$ inch as shown in Fig. 5.

If the distance between the needle and presser bars is more or less than $17/32$ inch, insert a screwdriver in the hole (B, Fig. 2) at the front of the machine and loosen the screw therein. While this screw is loose, the needle bar frame can be moved forward or backward, as may be required, until the distance between the needle and presser bars is $17/32$ inch. A piece of sheet metal $17/32$ inch wide may be used to determine the correct distance. When making this adjustment be sure to see that the stitch regulator is set so that there is no feeding movement. When the adjustment has been made, securely tighten the screw (B, Fig. 2).

Relative Positions of Vibrating and Lifting Presser Bars

(Machines 153K101 and 153K103)

The distance between the vibrating presser bar and lifting presser bar, after turning the feed regulating spindle head so that there is no feed movement of the needle bar, should be $17/64$ inch, as shown in Fig. 5A for Machine 153K103. The correct distance for Machine 153K101 is $17/64$ inch.

If the distance between the vibrating presser bar and the lifting presser bar is more or less, insert a screwdriver in the

hole (B, Fig. 2) at the front of the machine and loosen the screw therein. While this screw is loose, the needle bar frame can be moved forward or backward to the required distance. A piece of metal of the correct width may be used to determine the correct distance. When making this adjustment be sure to see that the feed regulating spindle head is set so that there is no feeding movement of the needle bar. When the adjustment has been made, securely tighten the screw at B (Fig. 2).

To Adjust the Relative Height of Lift of the Vibrating and Lifting Pressers

The amount of lift of the vibrating and lifting presser feet should be regulated according to the thickness of the material being sewn. The feet should lift just high enough to clear the material. As a rule, the vibrating and lifting pressers should lift an equal height, but some grades of work may require that they lift an unequal height. To change the relative lift of the presser feet, loosen the screw (G, Fig. 3) at the back of the machine and move the presser bar upwardly or downwardly as required, then securely tighten the screw (G).

To Set the Hook To or From the Needle

To prevent the point of the sewing hook from dividing the strands of the thread, it should run as close to the needle (within the scarf) as possible.

If the sewing hook runs too far from or too close to the needle, loosen the hook saddle screws (K, Fig. 17) just enough to permit the saddles to be driven by light blows to the position desired, then retighten the hook saddle screws.

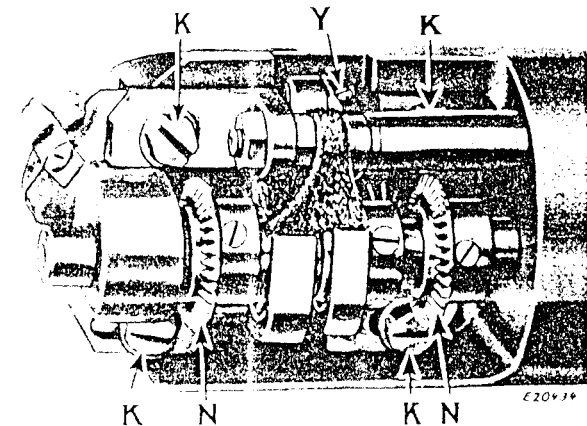

Fig. 17. Adjustment of Hook Saddles

To Time the Sewing Hook

Set the feed regulating spindle head so that there is no feeding action.

Remove the throat plate and turn the machine pulley over toward you until the lower mark across the needle bar is just visible at the end of the needle bar frame on the upward stroke of the needle bar. If the sewing hook is correctly timed with the needle bar, the point of the hook will be at the centre of the needle and about 1/16 inch above the eye.

If the hook is not timed correctly, loosen the two set screws in the hub of the hook driving gear (N, Fig. 17) and turn this gear on the shaft until the point of the hook is at the centre of the needle. Then securely tighten the two set screws in the gear.

To Remove the Bobbin Case and Hook from the Machine

Take out the hook gib screws and remove the gib (H, Fig. 18) to allow the bobbin case to be taken out, after which remove the

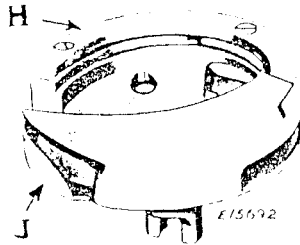

Fig. 18. Sewing Hook Removed from Machine, Showing Oiling Wick and Hook Washer (Needle Guard)

screw from the centre of the hook. Tap the hook lightly on the bottom of its rim to force it from its socket. Do not try to pry it out, as prying may bend the shank of the hook. When replacing the hook, be sure that the prongs of the shank properly enter the slot at the top of the socket, otherwise the hook will be out of time. Then replace the screw in the centre of the hook, replace the bobbin case and securely fasten the hook gib in position by means of the screws.

Needle Guard

The function of the hook washer (needle guard) (J, Fig. 18), which is attached to the bottom of each sewing hook, is to prevent

the point of the hook from striking the needle, if, when passing through the material, the needle is deflected toward the hook.

The needle guard can be bent with a small pair of pliers until it prevents the hook point from striking the needle, but it should not be bent outwardly enough to deflect the needle from its normal path.

To Adjust the Feed Dog

Usually when the feed dog is at its highest position, it should show a full tooth above the throat plate. To raise or lower the feed dog, remove the cylinder end cover, loosen the feed dog screw (D, Fig. 4) and adjust the feed dog to the required height, then securely tighten the feed dog screw (D). To adjust the feed dog on Machine 154K101, it will be necessary to remove the outside hook saddle and two screws (K, Fig. 17).

If the feed dog strikes the throat plate, tip the machine back and loosen the pinch screw (U, Fig. 23) of the feed driving rock shaft crank at the end of the rock shaft, then set the feed dog so that it will not strike when the longest stitch is made, and retighten the pinch screw (U).

To Adjust Feed Bar

(Except 153K101 which has no adjustment)

To compensate for looseness in feed bar mechanism, loosen screw (Y, Fig. 17) and tighten screw (Z, Fig. 18A), being careful not to make it bind the mechanism, and retighten screw (Y, Fig.

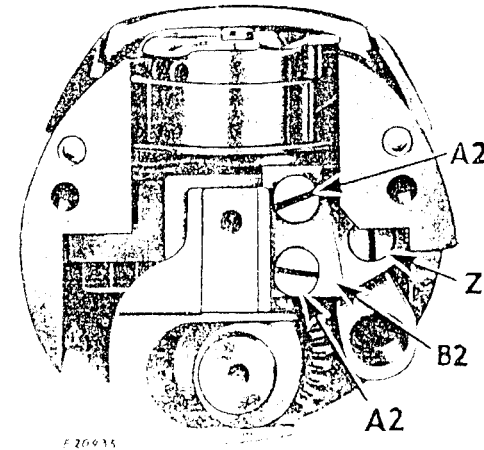

Fig. 18A. Adjustment of Feed Bar

17). Then loosen the screws (A2, Fig. 18A) and with a light pressure push the tapered gib (B2, Fig. 18A) upward, retighten the screws (A2, Fig. 18A). Caution: Before operating machine, make sure that the feed mechanism is not so tight as to cause a bind.

To Adjust the Mechanical Opener

The bobbin case lever (Q, Fig. 19) at the left of the sewing hook, actuated by the eccentric on the hook washer, strikes the

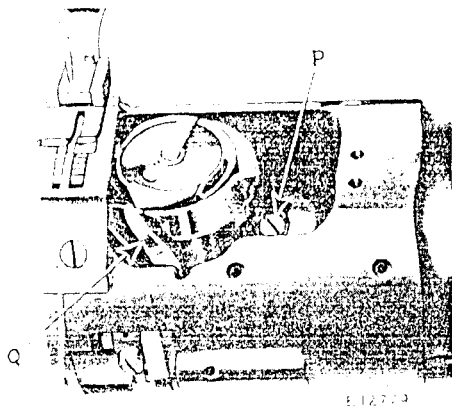

Fig. 19. Adjustment of Mechanical Opener

projection on the bobbin case and turns the bobbin case slightly, making an opening between the bobbin case stop and the stop on the throat plate when the thread is across the bobbin case and passing between the stops.

The bobbin case lever (Q) may be adjusted by loosening the bobbin case lever fulcrum screw (P, Fig. 19) and moving the fulcrum forward or backward.

This adjustment should be made so that the opening between the lever and the edge of the bobbin case is just perceptible when the bobbin case lever has opened the bobbin case all the way.

If the bobbin case lever is set to open the bobbin case too far, it will cause a bind between the bobbin case bearing and the hook bearing when the bobbin case is opened all the way, and care must be taken to see that this does not occur. When the correct adjustment of the bobbin case lever (Q) is made, securely tighten the fulcrum screw (P).

The above instructions apply to both bobbin cases in Machine 154K101, with the exception that the bobbin case lever for the left bobbin case is located at the right of the left sewing hook.

Adjustment of Feed Regulating Spindle Head

The figures on the feed regulating spindle head (DD, Fig. 20), showing through the notch in the machine pulley, indicate the

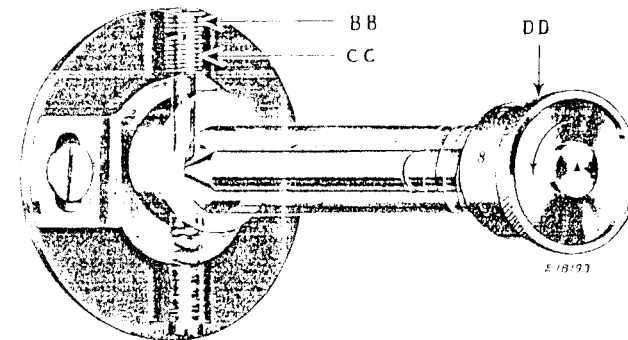

Fig. 20. "X-Ray" View of Feed Driving Eccentric Regulating Bracket and Shaft, Showing the Feed Regulating Spindle and Adjusting Screw (CC) Which Comes in Contact with the Cone of the Spindle to Gauge the Length of Stitch

number of stitches to the inch which should be made. If more or less stitches are made, adjust as follows: Remove screw (BB, Fig. 20), set the indicator at 8 and the feed dog at its highest point, a full tooth showing above the throat plate, then adjust screw (CC, Fig. 20) until eight stitches to the inch is the result and replace check screw (BB) firmly.

By making this adjustment with the stitch indicator set at 8 stitches, the full range of the stitch regulator is automatically taken care of so that the number appearing in the notch in the machine pulley will always indicate the correct number of stitches to the inch that the machine is ready to make.

TO SET THE FEED REGULATOR SO THAT A STITCH LONGER THAN THE ONE DESIRED CANNOT BE MADE. Turn the spindle head (DD, Fig. 20) as far as possible in the direction indicated by the arrow in Fig. 20; remove check screw (BB) and adjust screw (CC) until the machine makes the desired number of stitches to the inch, then turn screw (BB) down tightly on screw (CC) as a check. The stitches may then be changed by turning the stitch regulator (DD) for shorter stitches, but operators cannot make a longer stitch than that limited by the above adjustment.

To Remove the Needle Bar Rock Frame Rock Shaft

Remove the face plate and needle bar rock frame, then loosen the clamp screw (at B, Fig. 2) and draw out the rock shaft.

To Re-engage the Safety Clutch

The safety clutch in the lower belt pulley protects the sewing hooks from damage in case of accidental strain by releasing at a predetermined load.

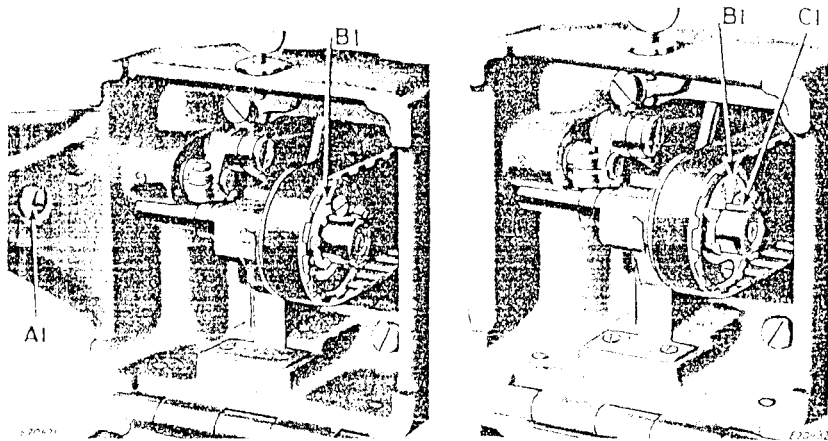

Fig. 21. Safety Clutch Disengaged Fig. 22. Operating Position

Draw back the bed slide, turn the machine pulley back and forth slightly, and remove the material that may be jamming the hook. If necessary to re-engage the clutch, press down the lock stud (A, Fig. 2) near the base of the arm to engage the hook driving shaft lock ratchet (A1, Fig. 21) which will prevent the hook driving shaft from turning backward. Turn the machine pulley away from you until the locking lever (B1) snaps into the notch (C1, Fig. 22) in the shaft collar as shown in Fig. 22. Release the lock stud and resume sewing.

To Remove the Arm Shaft Connection Belt from within the Arm

Slide the connection belt off the lower pulley; remove the feed regulating spindle head and machine pulley; loosen the arm shaft bushing screw (L, Fig. 3) at the back of the arm and remove

the bushing; lift the belt up through the arm cap hole as far as possible and draw it out through the space normally occupied by the bushing.

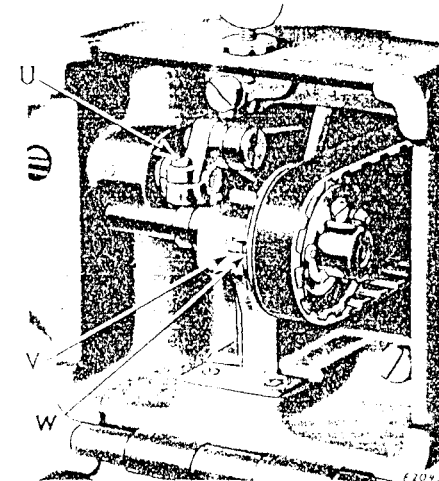

Fig. 23. Showing Timing Marks on Plate and Pulley

Owing to the fact that the sewing hook makes two revolutions to one revolution of the hook driving shaft, and that the feed lifting eccentric is on the hook driving shaft, it is possible to have the sewing hook correctly timed without having the feed correctly timed. To overcome this, the plate (V, Fig. 23) is attached to the underside of the bed of the machine. This plate is marked with an arrow at its forward end and directly alongside of the plate, the side of one of the teeth of the belt pulley is marked as shown at W in Fig. 23. When replacing the belt, replace the arm shaft bushing and securely fasten it in position by the screw (L, Fig. 3) at the back of the machine, replace the feed regulating spindle head and the machine pulley and place the belt on the upper pulley, then turn the machine pulley over toward you until the thread take-up lever is at its highest point. Then turn the hook driving shaft with the fingers until the arrow on the plate (V) and the timing mark on the belt pulley (W) are directly in line. Now, without disturbing either the arm shaft or the hook driving shaft, slip the belt over the lower pulley (Fig. 23). The feed will then be correctly timed with the needle bar.

CAUTION: DO NOT PINCH BELT in handling, as this will put a permanent kink in the wire reinforcements. Do not store near radiator or other hot place, preferably in a cool, dark place until belt is installed in machine.

The Same!

To get replacements
that are the same
as parts in new
machines...

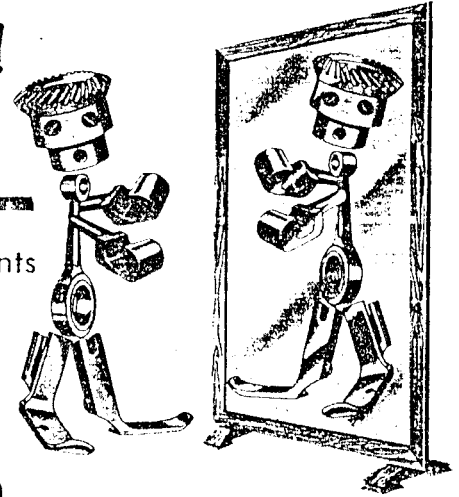

BUY PARTS AND
NEEDLES MADE BY **SINGER***

TO BE DOUBLY SURE...

of new machine performance, make sure that all
replacement parts and needles are precisely
identical to those in new SINGER machines.

Look for the trademark

SINGER or SIMANCO

- ① on every package or container
- ② on the needle or numbered part

Needles in containers marked "For Singer Machines" are NOT made by SINGER.

TO ALL WHOM IT MAY CONCERN:

The improper placing or renewal of the Trademark "SINGER" or any other of the Trademarks of The Singer Company (all of which are duly Registered Trademarks) on any machine that has been repaired, re-built, reconditioned, or altered in any way whatsoever outside a SINGER factory or an authorized SINGER agency is forbidden.