

SINGER
111W152,153,154,155

USE SINGER* OILS and LUBRICANTS

They insure freedom from lubricating trouble and give longer life to sewing equipment

The following are the correct lubricants for this machine:

TYPE B — MANUFACTURING MACHINE OIL, HEAVY GRADE

When an oil is desired which will produce a minimum of stain on fabrics, even after a long period of storage, use:

TYPE D — MANUFACTURING MACHINE OIL, HEAVY GRADE

OTHER SINGER* LUBRICANTS

TYPE E — THREAD LUBRICANT

For lubricating the needle thread of sewing machines for stitching fabrics or leather where a thread lubricant is required.

TYPE F — MOTOR OIL

For oil lubricated motors and plain bearings in power tables and transmitters.

NOTE: All of the above oils are available in 1 quart, 1 gallon and 5 gallon cans.

GEAR LUBRICANT

This specially prepared grease is recommended for gear lubrication on manufacturing sewing machines.

BALL BEARING LUBRICANT

This pure grease is specially designed for the lubrication of ball bearings and ball thrust bearings of motors and electric transmitters, ball bearing hangers of power tables, etc. Furnished in 1 lb. and 4 lb. tins.

Form 30262G
(863)

INSTRUCTIONS FOR USING AND ADJUSTING SINGER* SEWING MACHINES

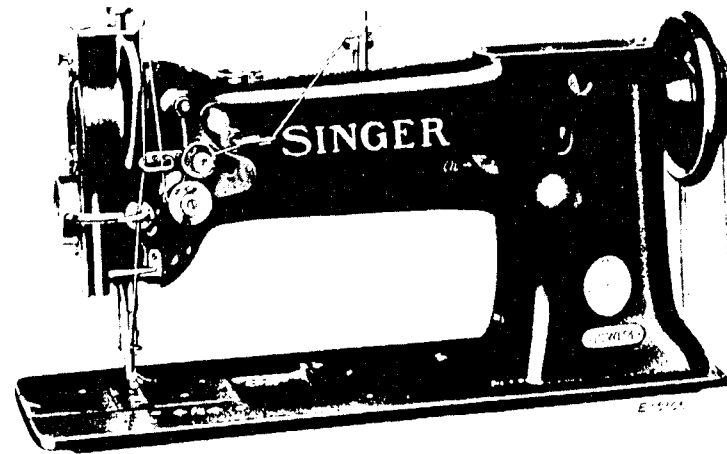

CLASS 111
(VARIETIES 152, 153, 154 and 155)

THE SINGER COMPANY

*A Trademark of THE SINGER COMPANY

Printed in Great Brit

DESCRIPTION

MACHINE 111w152 is a single needle, lock stitch, compound feed machine with a vertical-axis sewing hook, and alternating pressers having $\frac{3}{8}$ lift. It has a safety clutch which prevents the hook from being damaged or getting out of time due to accidental strain. The maximum stitch length is 5 to the inch. The machine is used for stitching light leather work such as leather gloves.

MACHINE 111w153 is similar to Machine 111w152 but is used for heavy work such as automobile and furniture upholstery, tents, awnings and leather coats.

MACHINE 111w154 is similar to Machine 111w152 but its alternating pressers have a lift of $\frac{1}{2}$ inch and the machine is designed for stitching upholstery work, leather coats, buff wheels and binding heavy felt padding.

MACHINE 111w155 is similar to Machine 111w154 except that its maximum stitch length is $3\frac{1}{2}$ to the inch and it has an adjustable lifting eccentric to instantly set the alternating pressers to the minimum amount of lift required for the work to be sewn.

SPEED

The maximum speed recommended for Machines 111w152, 111w153 and 111w154 is 2900 R. P. M. The speed depends on the material being stitched and the continuity of operation of the machine. The machines should also be run slower than the maximum speed until the parts which are in moving contact have become glazed by their action on each other. When the machine is in operation, the machine pulley turns over toward the operator.

The maximum speed for Machine 111w155 is 3500 R. P. M., depending on the material being stitched and thickness of the seams to be crossed.

NEEDLES

Needles for Machines 111w152, 111w153 and 111w155 are **Catalogue 3355 (136x17)** which are made in sizes 12, 14, 16, 18, 20, 22, 23, and 24.

Needles for Machine 111w154 are of **Catalogue 4506 (126x11)** which are made in sizes 22, 24, 25 and 27.

The size of the needle to be used should be determined by the size of the thread which must pass freely through the eye of the needle. If rough or uneven thread is used, or if it passes with difficulty through the eye of the needle, the successful use of the machine will be interfered with.

Orders for needles must specify the **QUANTITY** required, the **SIZE** number, also the **CATALOGUE** number.

The following is an example of an intelligible order:
"100 size 24, Catalogue 3355 Needles,
100 size 25, Catalogue 4506 Needles."

The best results will be obtained when using the needles sold by Singer Sewing Machine Company.

CAUTION

After setting up, do not start the machine, not even to test the speed, until it has been thoroughly oiled, as instructed below.

TO OIL THE MACHINE

To insure easy running and prevent unnecessary wear of the parts which are in movable contact, the machine requires oiling, and when in continuous use, it should be oiled at least twice each day. A new machine should be oiled more frequently when it is in continuous use on long runs.

Use "TYPE B" or "TYPE D" OIL, sold by Singer Sewing Machine Company. For description of oils, see inside of front cover.

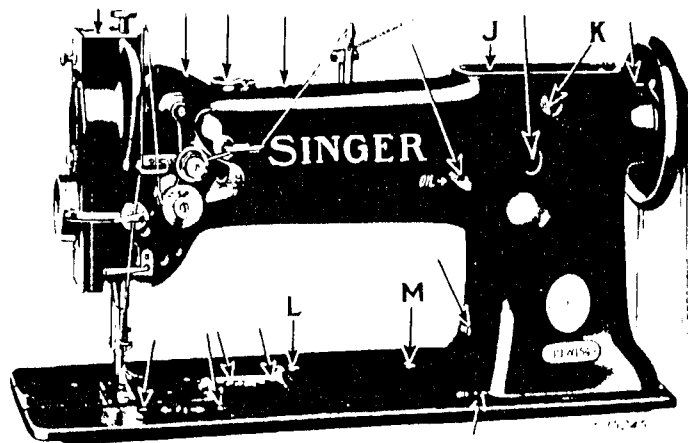

Fig. 2. Front of Machine Showing Oiling Points and Adjustments

Oil should be applied at the places designated by unmarked arrows in Figs. 2 to 6. Swing back the top cover (J, Fig. 2) and oil the bearings which are thus uncovered, then replace the cover.

Loosen the thumb screw in the upper end of the face plate, turn the face plate upward and oil the wick and bearings shown in Fig. 3, then turn down the face plate and tighten the thumb screw.

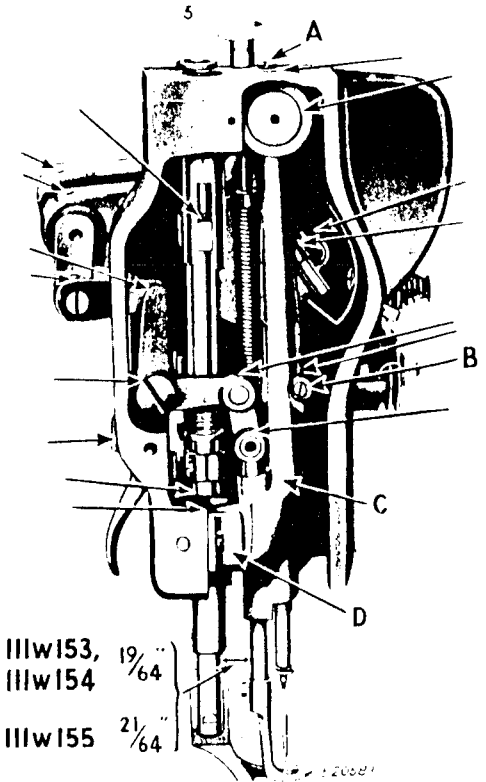

Fig. 3. End View of Machine Showing Oiling Points and Adjustments

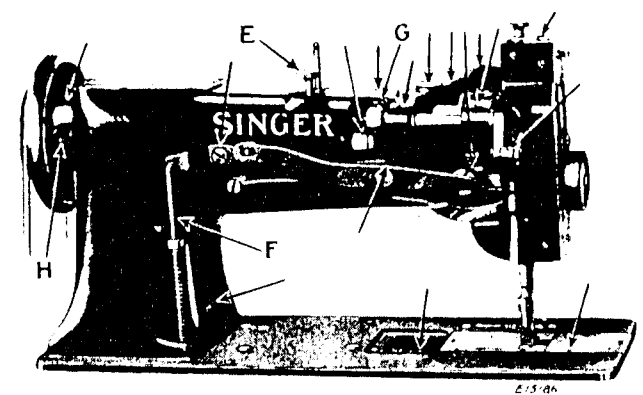

Fig. 4. Rear View of Machine Showing Oiling Points and Adjustments

Turn the machine back on its hinges and apply the oil at the places designated by unlettered arrows as shown in Fig. 5, and all other places where there are parts in movable contact, then bring the machine forward into place.

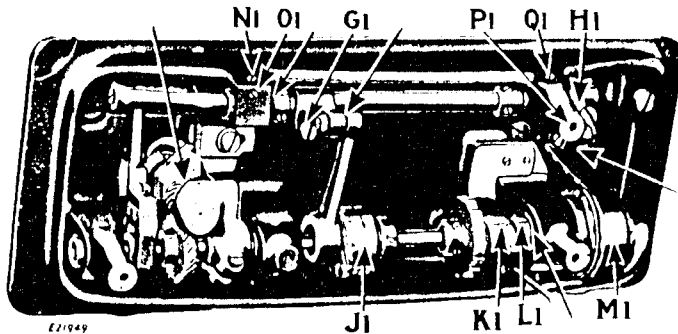

Fig. 5. Base of Machine
Showing Oiling Points and Adjustments

HOOK LUBRICATION

Oil should be placed in the oil well (P, Fig. 6) to lubricate the upper hook bearing and the mechanical opener mechanism.

The small green felt pad (Q, Fig. 6) on the side of the bobbin case should be kept wet with oil to lubricate the hook race. When this pad is wet it appears nearly black, and when it appears light green it indicates that it is dry. When a machine is new, oil should be applied to this felt pad each time a bobbin is replaced.

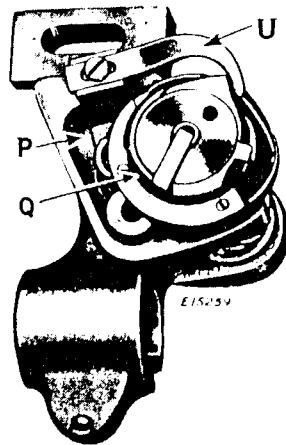

Fig. 6. Hook Lubrication

TO ADJUST THE THREAD LUBRICATOR FOR MACHINES 111w152, 111w153 AND 111w154

When replenishing the lubricant supply, fill the reservoir (A, Fig. 12) to about $\frac{1}{8}$ inch below the filler hole (B, Fig. 12).

The amount of lubrication of the thread is controlled by raising or lowering the felt pad holder (12, Fig. 12) above or below the level of the lubricant. For more lubricant, lower the felt pad holder. For less lubricant, raise the felt pad holder.

ADJUSTMENT OF THREAD LUBRICATOR FOR MACHINE 111w155

When replenishing the supply of thread lubricant, pour only enough into the reservoir to partly immerse the oil pad.

The amount of lubrication of the thread is controlled by the thumb nut (A, Fig. 13). For more lubricant, turn down this thumb nut. For less lubricant, turn up the thumb nut.

NOTE: To insure satisfactory results, SINGER "TYPE E" THREAD LUBRICANT, sold by Singer Sewing Machine Company, should be used in the above thread lubricators.

THREAD

Use left twist thread for the needle. Either left or right twist thread may be used for the bobbin.

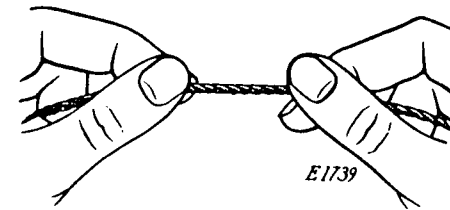

Fig. 7. How to Determine the Twist

Hold the thread as shown above. Turn the thread over toward you between the thumb and forefinger of the right hand; if left twist, the strands will wind tighter; if right twist, the strands will unwind.

RELATIVE SIZES OF NEEDLES AND THREAD

Size Numbers of Needles	Cotton Thread	Silk Thread
10	100 to 150	000 to 00
11	90 " 150	00
12	80 " 90	0
13	70 " 80	A
14	60 " 70	A
15	50 " 60	B
16	40 " 50	C
18	30 " 40	C
20	24 " 30	D
22	16 " 24	E

TO SET THE NEEDLE

Turn the machine pulley over toward you until the needle bar moves up to its highest point; loosen the set screw in the needle bar and put the needle up into the bar as far as it will go, with its long groove toward the left, the eye of the needle being directly in line with the machine bed, then tighten the set screw.

TO REMOVE THE BOBBIN

Draw out the slide plate in the bed of the machine. Insert the finger nail of the forefinger under the latch (C, Fig. 8), raise the latch and lift out the bobbin.

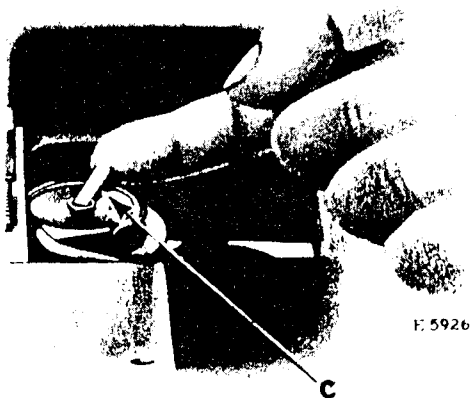

Fig. 8. Removing the Bobbin

TO WIND THE BOBBIN

(See Fig. 9)

Fasten the bobbin winder to the table with its driving pulley in front of the machine belt, so that the pulley will drop away from the belt when sufficient thread has been wound upon the bobbin.

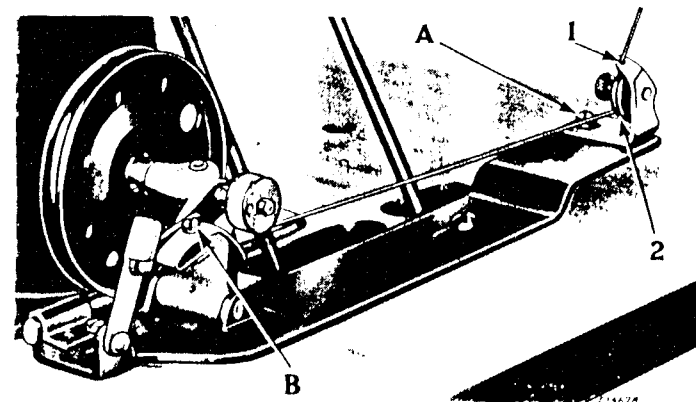

Fig. 9. Winding the Bobbin

Place the bobbin on the bobbin winder spindle and push it on as far as it will go.

Pass the thread down through the thread guide (1) in the tension bracket, around the back and between the tension discs (2). Then wind the end of the thread around the bobbin a few times, push the bobbin winder pulley over against the machine belt and start the machine.

When sufficient thread has been wound upon the bobbin, the bobbin winder will stop automatically.

If the thread does not wind evenly on the bobbin, loosen the screw (A) in the tension bracket and move the bracket to the right or left as may be required, then tighten the screw.

The amount of thread wound on the bobbin is regulated by the screw (B). To wind more thread on the bobbin, turn the screw (B) inwardly. To wind less thread on the bobbin, turn this screw outwardly.

Bobbins can be wound while the machine is stitching.

TO REPLACE THE BOBBIN AND THREAD THE BOBBIN CASE

Hold the bobbin between the thumb and forefinger of the right hand, the thread drawing on the bottom from left to right as

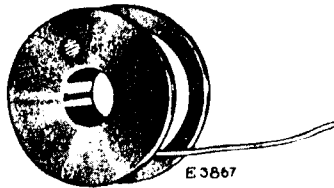

Fig. 10. Direction of Thread on Bobbin

shown in Fig 10, and place it on the center stud of the bobbin case, then push down the latch C, Fig. 11. Draw the thread into the slot 1, Fig. 11 and under the back of the projection 2, Fig. 11, leaving a loose end of thread about two inches long above the slide. When closing the slide plate, leave just enough space for the thread to pass through.

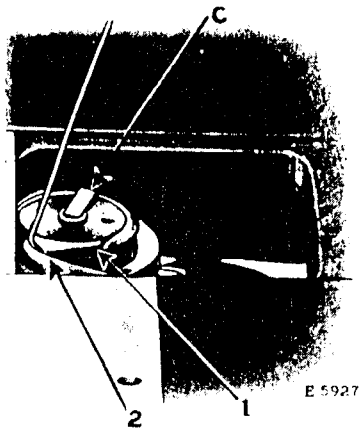

Fig. 11. Bobbin Case Threaded

TO PREPARE FOR SEWING

With the left hand hold the end of the needle thread, leaving it slack from the hand to the needle. Turn the machine pulley over toward you until the needle moves down and up again to its highest point, thus catching the bobbin thread; draw up the needle thread and the bobbin thread will come up with it through the hole in the feed dog. Lay the threads back under the presser feet and close the slide.

TO START SEWING

Place the material beneath the presser feet, lower the presser feet and start to sew, turning the machine pulley over toward you.

TO REMOVE THE WORK

Have the thread take-up lever at the highest point, raise the presser feet, draw the work back and cut the threads close to the goods. Lay the ends of the threads back under the presser feet.

TENSIONS

The needle and bobbin threads should be locked in the centre of the thickness of the material, thus:



Fig. 15. Perfect Stitch

If the tension on the needle thread is too tight, or if that on the bobbin thread is too loose, the needle thread will lie straight along the upper surface of the material, thus:



Fig. 16. Tight Needle Thread Tension

If the tension on the bobbin thread is too tight, or if that on the needle thread is too loose, the bobbin thread will lie straight along the under side of the material, thus:



Fig. 17. Loose Needle Thread Tension

TO REGULATE THE TENSIONS

The tension on the needle thread is regulated by the thumb nut (R, Fig. 18) at the front of the tension discs on the front of the machine. To increase the tension, turn this thumb nut over to the right. To decrease the tension, turn this thumb nut over to the left.

The tension on the bottom thread is regulated by means of the screw nearest the centre of the tension spring on the outside of the bobbin case. To increase the tension, turn this screw over to the right. To decrease the tension, turn this screw over to the left.

TO REGULATE THE LENGTH OF STITCH

The number of stitches per inch is stamped on the stitch indicating disc (K, Fig. 2) located on the arm shaft.

To change the length of stitch, press down the plunger (L, Fig. 2) in the bed of the machine and at the same time turn the machine pulley slowly until the plunger enters a notch in the adjustable feed eccentric cam (J1, Fig. 5). Still holding the plunger, turn the machine pulley forward or backward as required until the number of stitches per inch desired can be seen through the hole in the front of the arm (at K, Fig. 2), then release the plunger.

TO REGULATE THE PRESSURE ON MATERIAL

The pressure on the material is regulated by the screw (E, Fig. 4) at the back of the machine, the screw acting on a flat spring. To increase the pressure, turn this screw downward. To decrease the pressure, turn this screw upward. The pressure should be only heavy enough to enable the feed to move the work along evenly.

UPPER THREADING FOR MACHINES 111w152, 111w153 AND 111w154

Pass the thread from the unwinder from back to front through the lower hole (1) in the pin on top of the machine and from right to left through the

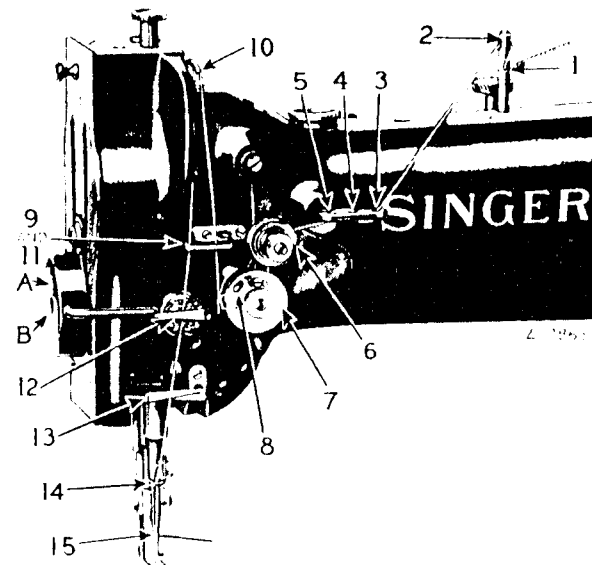

Fig. 12. Upper Threading

upper hole (2) in the pin, down through the hole (3), up through the hole (4) and down through the hole (5) in the thread guide at the front of the machine, over from right to left between the tension discs (6), down, under from right to left around the thread controller (7), up into the fork (8) in the thread controller disc against the pressure of the wire controller spring, up through the thread guide (9), from right to left through the hole (10) in the thread take-up lever, down through the thread guide (11), between the felt pad and felt pad retainer finger (12) and through the thread guide (13), through the thread guide (14) at the bottom of the needle bar and from left to right through the eye of the needle (15).

UPPER THREADING FOR MACHINE 111w155

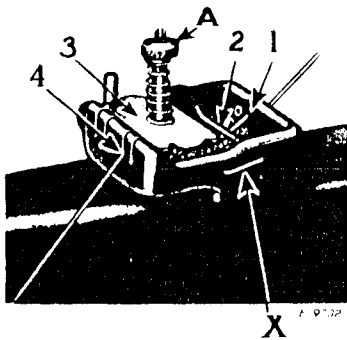

Fig. 13. Upper Threading

Pass the thread from the unwinder through one of the holes (1) in the thread lubricator, and under the wire guide (2), (which may be raised by prying the end (X) out of its position hole and turning it to the right), then under the oil pad (3) and out through one of the notches (4) in the thread lubricator, downward through the hole (5), up through the hole (6) and down through the hole (7) in the thread guide at the front of the machine, over from right to left between the tension discs (8), down,

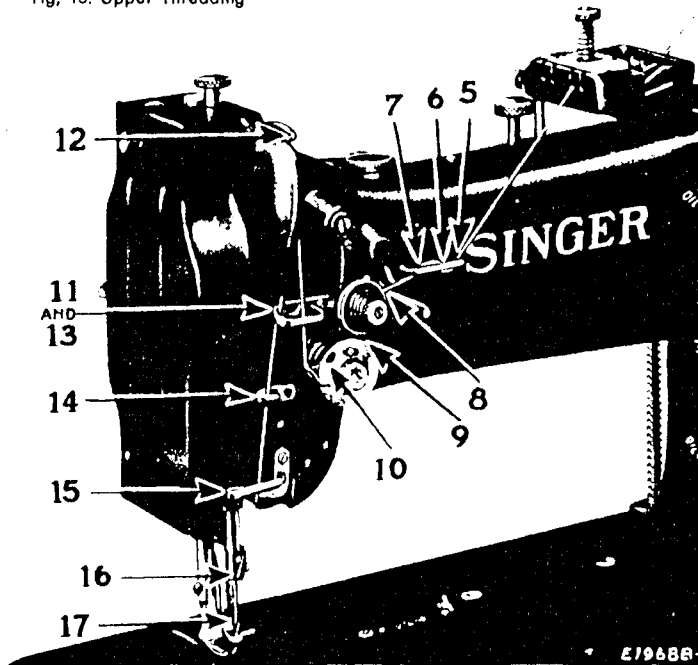

Fig. 14. Upper Threading

under from right to left around the thread controller (9), up into the fork (10) in the thread controller disc against the pressure of the wire controller spring, up through the thread guide (11), from right to left through the hole (12) in the thread take-up lever, down through the thread guides (13, 14 and 15), through the thread guide (16) at the bottom of the needle bar and from left to right through the eye of the needle (17).

INSTRUCTIONS

FOR

ADJUSTERS AND MECHANICS

THREAD CONTROLLER

The function of the thread controller spring is to hold back the slack of the needle thread until the eye of the needle nearly reaches the goods in its descent, as without this controlling action of the spring, the slack thread or silk (more especially silk) will sometimes be penetrated by the point of the needle as the needle is descending.

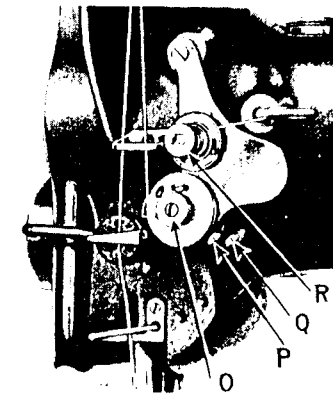

Fig. 18. Adjustment of Thread Controller

For more controller action on the thread, loosen the top screw (P, Fig. 18) at the right of the tension and set the stop lower, and for less action, set the stop higher.

To strengthen the action of the controller spring on the thread, loosen the tension stud screw (Q, Fig. 18) at the right of the stop screw and turn the tension stud (O, Fig. 18) slightly to the left with a screwdriver, or to lighten its action, turn to the right and retighten the tension stud screw.

TO SET THE NEEDLE BAR

See that the needle is up in the bar as far as it will go. There are two lines across the needle bar about two inches above the lower end. When the needle bar is at its lowest position, the upper mark should be just visible at the end of the needle bar frame.

In case the needle bar is not correctly set, loosen the needle bar connecting stud pinch screw (B, Fig. 3) and place the needle bar in correct position as directed above, then retighten the screw (B).

TO SET A NEEDLE BAR WHICH HAS NO MARK: Set the feed eccentric for 8 stitches to the inch; then set the needle bar so that when it rises $\frac{3}{32}$ inch from its lowest position and the point of the sewing hook is at the centre of the needle, the needle eye will be about $\frac{1}{16}$ inch below the hook point.

FORWARD-AND-BACK POSITION OF NEEDLE BAR AND VIBRATING PRESSER BAR FRAME

The needle bar frame (C, Fig. 3) should be set so that a straight needle is centred in the needle hole in the feed dog (or slightly more toward the operator) throughout their feeding movement. It should also be set so that when the feed eccentric is set for zero feeding movement, the distance between the vibrating presser bar and the lifting presser bar will be $\frac{19}{64}$ inch for Machines 111w152, 111w153 and 111w154 and $\frac{21}{64}$ inch for Machine 111w155, as shown in (Fig. 3).

If the needle bar is not centred correctly in the needle hole in the feed dog, adjust the feed eccentric for zero feeding movement, then loosen the clamp screw in the crank (H1, Fig. 5), and also the screw reached through the hole (F, Fig. 4) in the back of the arm; centre the needle with the feed dog, and see that the crank (H1, Fig. 5) is parallel with the top surface of the bed before tightening the two clamp screws.

If the vibrating presser bar is now the wrong distance from the lifting presser bar, with zero feeding movement, loosen clamp screw (G1, Fig. 5) and set the bars $\frac{19}{64}$ inch apart for Machines 111w152, 111w153 and 111w154, and $\frac{21}{64}$ inch for Machine 111w155, then tighten the screw (G1). A piece of sheet metal $\frac{19}{64}$ or $\frac{21}{64}$ inch wide may be used as a gauge for determining the right distance, depending on machine.

TO ADJUST THE RELATIVE HEIGHT OF LIFT OF THE VIBRATING AND LIFTING PRESSERS

The amount of lift of the vibrating and lifting presser feet should be regulated according to the thickness of the material being sewn. The feet should lift just high enough to clear the material. As a rule, the vibrating and lifting pressers should lift an equal height, but some grades of work may require that they lift an unequal height. To change the relative lift of the presser feet, loosen the screw (G, Fig. 4) at the back of the machine and move the presser bar up or down as required, then securely tighten the screw (G).

TO ADJUST THE HEIGHT OF LIFT OF THE VIBRATING AND LIFTING PRESSERS ON MACHINE 111w155

The amount of lift of the alternating presser feet should be regulated according to the thickness of the material being sewn. The feet should lift just high enough to clear the material. Normally, the feed should lift an equal height, but some grades of work may require that they lift an unequal

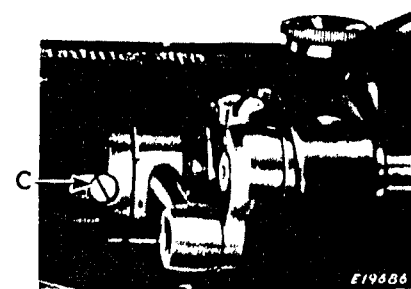

Fig. 19

height. To change height of lift of the presser feet, loosen the set screw (C, Fig. 19) in the lifting eccentric and turn the machine pulley so that the adjusting screw (D, Fig. 20) is accessible. To increase the amount of lift, turn the screw (D) counterclockwise. To decrease the amount of lift, turn the screw (D) clockwise. Then turn the machine pulley and retighten the screw (C).

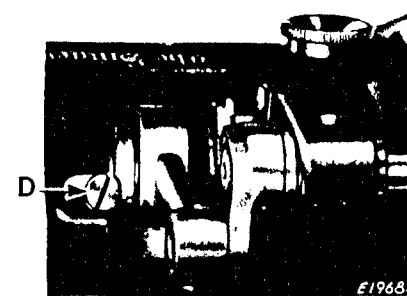

Fig. 20

TO TIME THE SEWING HOOK

Set the feed eccentric so that there is no feeding motion.

Remove the throat plate and turn the machine pulley over toward you until the lower mark across the needle bar is just visible at the end of the needle bar frame on the upward stroke of the needle bar. If the needle bar and sewing hook are correctly timed, the point of the hook will be at the centre of the needle and about 1/16 inch above the eye.

In case the sewing hook is not correctly timed, turn the machine pulley over toward you until the needle bar has descended to its lowest point and has risen until the lower timing mark across the needle bar is just visible at the end of the needle bar frame.

Loosen the two screws in the hub of the hook driving gear (U, Fig. 21) and tap this gear to the right on the hook driving shaft for an earlier hook timing, or to the left for a later hook timing. When the correct timing is obtained, securely tighten the two set screws in the hub of the gear.

TO SET THE SEWING HOOK TO OR FROM THE NEEDLE

To prevent the point of the hook from dividing the strands of the thread, it should run as close to the needle (within the scarf) as possible.

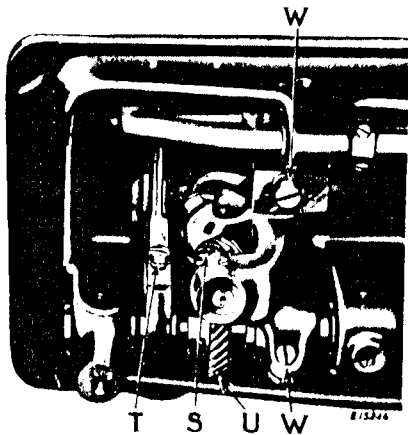

Fig. 21. Adjustment of Hook Saddle

Turn the machine pulley over toward you until the point of the sewing hook is at the centre of the needle. Loosen the two screws (W, Fig. 21) underneath the bed of the machine and move the hook saddle to the right or left, as may be required, until the point of the hook is as close to the needle as possible without striking it, then securely tighten the two screws (W).

TO REMOVE THE SEWING HOOK FROM THE MACHINE

Remove the bed slide, throat plate, feed dog, and the bobbin case opening lever (U, Fig. 6). Then turn back the machine and loosen the two screws in the hub of the hook shaft gear (S, Fig. 21) and lift out the sewing hook.

TO ADJUST THE NEEDLE GUARD ON THE SEWING HOOK

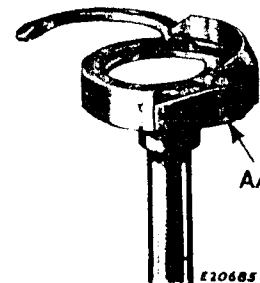

Fig. 22. Sewing Hook Removed from Machine Showing Hook Washer

On Machines 111w152, 111w153 and 111w154, the needle guard washer (AA, Fig. 22), which is attached to the bottom of the sewing hook, should be sprung until it prevents the needle from striking the hook in case the needle is deflected towards the hook.

On Machine 111w155, the needle guard washer (B, Fig. 23), which is attached to the side of the sewing hook should be sprung until it prevents the needle from striking the hook in case the needle is deflected towards the hook.

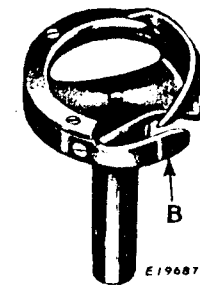

Fig. 23

TO ADJUST THE FEED ROCK SHAFT BEARINGS

The feed rock shaft is carried in split bushings which can be adjusted to take up any wear which may occur. Loosen the two lock screws (O1 and Q1, Fig. 5) and turn in the two adjusting screws (N1 and P1) until all lost motion of the rock shaft has been eliminated, then securely tighten the lock screws.

TO RAISE OR LOWER THE FEED DOG

Usually when the feed dog is at its highest position, it should show a full tooth above the throat plate.

Remove the throat plate; clean the lint and dust from between the feed points and replace the throat plate; tip the machine back and turn the machine pulley toward you until the feed dog is at its highest position; loosen screw (T, Fig. 21) in the feed lifting cam fork on the feed bar and raise or lower the feed dog, as may be required, and retighten the screw (T).

When raising or lowering the feed dog, be careful that its underside does not drop low enough to strike the sewing hook.

THE FEED ECCENTRIC

The feed eccentric is provided with a gib (B1, Fig. 24) which can be adjusted to take up any wear or loose motion between the feed eccentric and the eccentric body. To adjust the gib, loosen the two locking screws (C1, Fig. 24) nearest the gib, then turn in the two adjusting screws (D1) against the gib until all play is eliminated and the eccentric fits snugly in the slot in the eccentric body. Securely tighten the two locking screws (C1).

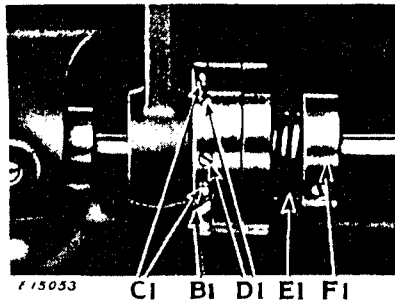

Fig. 24. Feed Eccentric

The spring (E1) presses against the feed eccentric cam to prevent it from moving out of position while the machine is operating. The collar (F1) may be moved to the right or left to change the spring pressure. It should ordinarily be set flush with the end of the hub of the eccentric body.

TO ADJUST THE STITCH LENGTH INDICATOR

Set the machine to produce eight measured stitches to the inch. Then loosen the set screw in the stitch indicating disc (K, Fig. 2); press down the plunger (L, Fig. 2) in the bed of the machine and at the same time turn the machine pulley slowly until the plunger enters the notch in the adjustable feed eccentric cam. With the machine in this position, the stitch indicating disc (K, Fig. 2) should be set so that the figure "8" can be seen through the hole in the front of the arm, then tighten the set screw in the stitch indicating disc.

TO REMOVE THE NEEDLE BAR ROCK FRAME ROCK SHAFT

Remove the face plate; remove the bracket (D, Fig. 3), loosen the hinge stud set screw (A, Fig. 3), and remove the rock frame (C, Fig. 3); then loosen the clamp screw (at F, Fig. 4) and draw out the rock shaft.

TO REMOVE AND REPLACE THE ARM SHAFT CONNECTION BELT

Remove the machine pulley, then loosen the screw (H, Fig. 4) at the rear of the machine, which holds the arm shaft bushing. The bushing can then be removed from the machine. Remove the belt from the lower pulley, then lift the belt up through the arm cap hole as far as possible and draw it out through the space normally occupied by the arm shaft bushing.

Owing to the fact that the sewing hook makes two revolutions to one revolution of the hook shaft, and that the feed eccentric is on the hook shaft, it is possible to have the sewing hook correctly timed without having the feed eccentric correctly timed. To overcome this, a plate attached to the underside of the bed is marked with an arrow (K1, Fig. 5) and the collar on the hook shaft is also marked with an arrow (L1, Fig. 5).

After replacing the belt over the arm shaft, replace the arm shaft bushing and securely fasten it in position by the screw (H, Fig. 4); replace the machine pulley, place the belt on the upper pulley, and turn the machine pulley over toward you until the thread take-up lever is at its highest point; then turn the hook shaft with the fingers until the arrow (L1, Fig. 5) on the collar is directly in line with the arrow (K1, Fig. 5). Now, without disturbing either the arm shaft or the hook shaft, slip the belt over the lower pulley (see Fig. 25). The feed will then be correctly timed with the needle bar.

CAUTION—DO NOT PINCH BELT in handling, as this will put a permanent kink in the wire reinforcements. Do not store near excessive heat. Store in a cool, dark place until belt is installed in machine.

TO RE-ENGAGE THE SAFETY CLUTCH

The hook driving shaft and the shaft of the sewing hook are splined to prevent the hook from getting out of time. The safety clutch located in the lower belt pulley prevents damage in the event of any strain on the sewing hook by releasing the locking lever in the pulley from the notch (C1, Fig. 26) in the collar of the hook driving shaft.

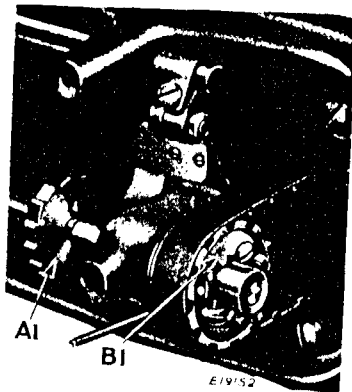

Fig. 25. Safety Clutch Disengaged

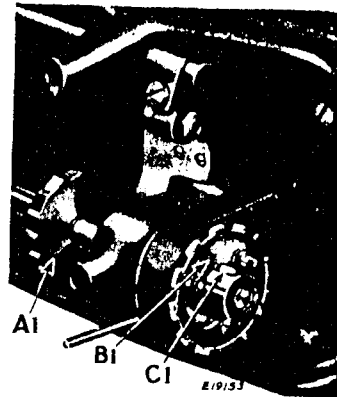

Fig. 26. Operating Position

Draw back the bed slide, turn the machine pulley back and forth slightly, and remove the material that may be jamming the hook. If necessary to re-engage the clutch, press down the lock stud (M, Fig. 2) near the base of the arm to engage the hook driving shaft lock ratchet (A1, Fig. 25) which will prevent the hook driving shaft from turning backward. Turn the machine pulley away from you until the locking lever (B1) snaps into the notch (C1) in the shaft collar as shown in Fig. 26. Release the lock stud and resume sewing.