

SINGER
112W116,W120,113W110

USE ONLY SINGER OILS and LUBRICANTS

*They insure freedom from lubricating trouble and
give longer life to sewing equipment*

"Singer Oil for High Speed Sewing Machines"

(Cloth and Leather)

For all manufacturing sewing machines except where a stainless oil is desired.

"Singer Stainless Oil for High Speed Sewing Machines"

For all manufacturing sewing machines where a stainless oil is desired.

"Singer Motor Oil"

For oil-lubricated motors, power tables, transmitters and machinery in general.

"Singer Stainless Thread Lubricant"

For lubricating the needle thread of sewing machines for stitching fabrics or leather where a stainless thread lubricant is required.

NOTE: All of the above oils are available in 1 quart, 2 quart, 1 gallon and 5 gallon cans or in 55 gallon drums, and can also be supplied in customer's containers.

"Singer Gear Lubricant"

This specially prepared grease is recommended for gear lubrication on manufacturing sewing machines.

"Singer Ball Bearing Lubricant"

This pure grease is specially designed for the lubrication of ball bearings and ball thrust bearings of motors and electric transmitters, ball bearing hangers of power tables, etc.

NOTE: The above greases are furnished in ¼ lb. tubes and 1 lb. and 4 lb. tins.

Copyright, U. S. A.,
1914, 1915, 1916, 1917, 1918, 1922, 1925, 1926, 1927, 1934, 1935 and 1940,
by The Singer Manufacturing Company
All Rights Reserved for all Countries

Form 2049 w

INSTRUCTIONS FOR USING SINGER SEWING MACHINES

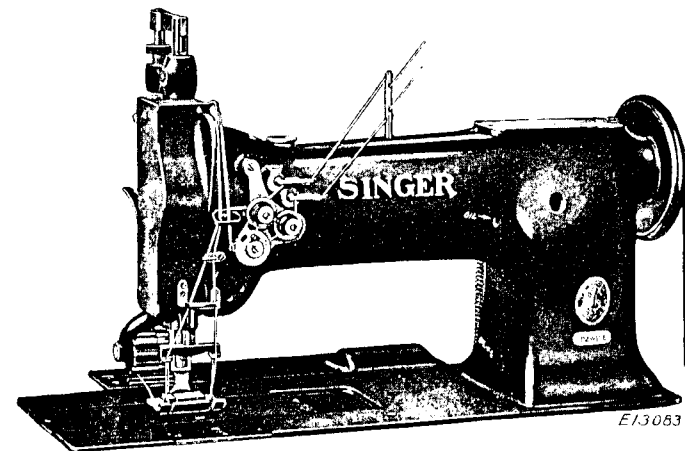

112w116, 112w120

AND 113w110

FOR

TWO-LINE LOCK STITCHING IN FABRICS

THE SINGER MANUFACTURING CO.

To all whom it may concern:

The placing or renewal of the name "Singer" (Reg. U. S. Pat. Off.) or any of the trade marks of The Singer Manufacturing Company on any machine that has been repaired, rebuilt, reconditioned, or altered in any way whatsoever outside a Singer factory or an authorized Singer agency is forbidden.

THE IMPORTANCE OF USING
GENUINE SINGER PARTS AND NEEDLES
IN SINGER MACHINES

The successful operation of Singer machines can only be assured if genuine Singer parts and needles are used. Supplies are available at all Singer Shops for the Manufacturing Trade and mail orders will receive prompt attention.

Genuine Singer Needles should be used
in Singer Machines.
These Needles and their Containers
are marked with the
Company's Trade Mark "SIMANCO." 1

Needles in Containers marked
"For Singer Machines"
are not Singer made needles. 2

DESCRIPTION

Machine 112 w 116 has two needles and two belt driven rotary hooks and is designed for simultaneously making two parallel lines of lock stitching in fabrics. The distance between the needles may be from $\frac{3}{8}$ to 2 inches, as ordered. The machine is equipped with a puller feed in addition to a needle feed and drop feed and is therefore especially adapted for use in the manufacture of bulky work such as tents, awnings, balloons, flags, etc. It is also used for banding overalls and pants, attaching collars to jackets, jumpers, etc., and for general stripping operations on heavy work.

Machine 112 w 120 is made in gauges from $\frac{1}{8}$ to $1\frac{1}{2}$ inches and is intended for two-line lock stitching in light and medium weight fabrics. It is extensively used in the manufacture of shirts, waists, wrappers, etc. It has a drop feed and a hinged presser foot.

Machine 113 w 110 is made in gauges from $\frac{1}{8}$ to 3 inches and is used for two-line lock stitching in balloons, aircraft work, for sewing celluloid into automobile curtains and for stitching articles of large and awkward sizes. It has an extra long arm and is equipped with a puller feed in addition to a drop feed and will sew up to six thicknesses of No. 8 duck.

Speed

The maximum speeds recommended for the machines are as follows:

- Machine 112 w 116 - 2800 per minute
- Machine 112 w 120 - 3000 per minute
- Machine 113 w 110 - 2400 per minute

Run the machines slower than the maximum speed until the parts which are in movable contact have become glazed by their action upon each other. When the machines are in operation, the balance wheel should always turn over toward the operator.

Needles

Needles for Machines 112 w 116, 112 w 120 and 113 w 110 are of the following Class and Variety numbers:

MACHINE	CLASS AND VARIETY	SIZES
112w116	126x3	10, 12, 14, 16, 18, 20, 22, 23 and 24
112w120	135x7	7, 8, 9, 10, 12, 14, 16, 18, 20, 22 and 24
	135x11	9, 10, 12, 14, 16, 18 and 20
	for corset work	
113w110	135x7	7, 8, 9, 10, 12, 14, 16, 18, 20, 22 and 24

The size of the needles to be used should be determined by the size of the thread which must pass freely through the eye of the needles. If rough or uneven thread is used or if it passes with difficulty through the eye of the needles, the successful use of the machine will be interfered with.

Orders for needles must specify the **quantity** required, the **size number**, also the **class** and **variety** numbers separated by the letter x.

The following is an example of an intelligible order:

"100 No. 14, 135x7 Needles."

The best results will be obtained in using the needles furnished by the Singer Sewing Machine Company.

Thread

Use left twist thread for both needles. Either left or right twist thread may be used for the bobbins.

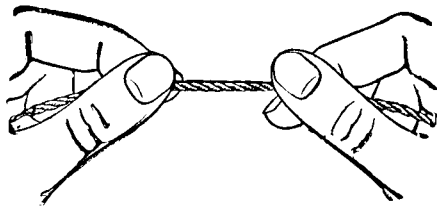

Fig. 2. How to Determine the Twist

Hold the thread as shown above. Turn the thread over toward you between the thumb and the forefinger of the right hand; if left twist, the strands will wind tighter; if right twist, the strands will unwind.

Relative Sizes of Needles and Thread

SIZE NUMBERS OF NEEDLES	COTTON THREAD	SILK THREAD
10	100 to 150	000 to 00
11	90 " 100	00
12	80 " 90	O
13	70 " 80	A
14	60 " 70	A
15	50 " 60	B
16	40 " 50	C
18	30 " 40	C
20	24 " 30	D
22	16 " 24	E

To Set the Needles

Turn the balance wheel over toward you until the needle bar moves up to its highest point; loosen the set screws in the needle holder and put the needles up into the holder as far as they will go, the inside needle or the one nearest the upright part of the arm having its long groove toward the left, and the outside needle or the one farthest from the upright part of the arm having its long groove toward the right, the eyes of both needles being directly in line with the machine bed, then tighten the set screws.

To Remove the Bobbins

Machine 112w116

Draw out the slide plates in the bed of the machine. Turn the balance wheel over toward you until the needle bar moves up to its highest point. Place the thumb or finger under the projection on the side of the bobbin case cap as shown in Fig. 3, then lift out the cap and remove the bobbin.

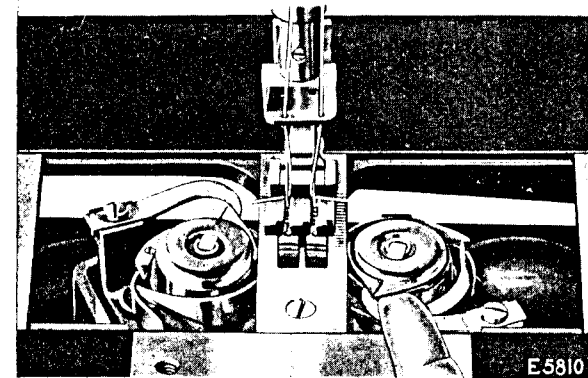

Fig. 3. Removing the Bobbin

To Remove the Bobbins

Machines 112w120 and 113w110

Draw out the slide plates in the bed of the machine. Insert the finger nail of the forefinger under the latches (A and B, Fig. 4), raise the latches and lift out the bobbins.

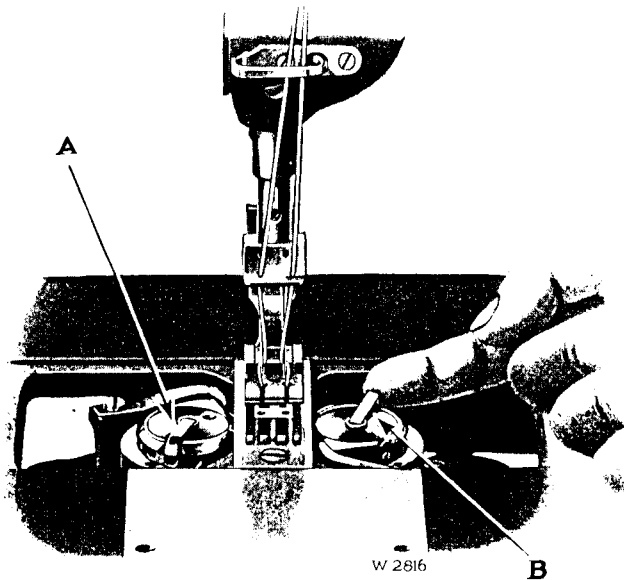

Fig. 4. Removing the Bobbin

To Wind the Bobbin

(See Fig. 5)

Fasten the bobbin winder to the table with its driving pulley in front of the machine belt, so that the pulley will drop away from the belt when sufficient thread has been wound upon the bobbin.

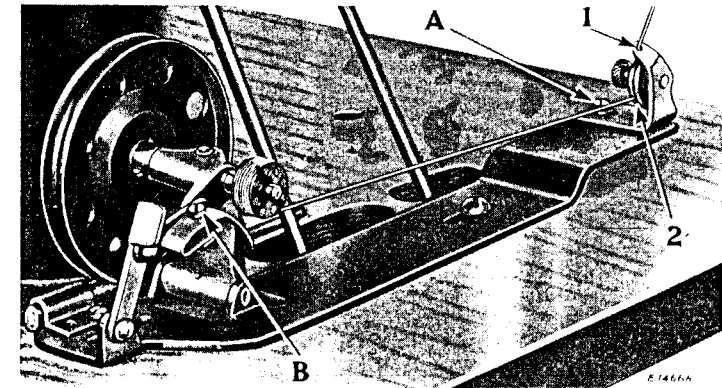

Fig. 5. Winding the Bobbin

Place the bobbin on the bobbin winder spindle and push it on as far as it will go.

Pass the thread down through the thread guide (1) in the tension bracket, around the back and between the tension discs (2). Then wind the end of the thread around the bobbin a few times, push the bobbin winder pulley over against the machine belt, and start the machine.

When sufficient thread has been wound upon the bobbin, the bobbin winder will stop automatically.

If the thread does not wind evenly on the bobbin, loosen the screw (A) in the tension bracket and move the bracket to the right or left, as may be required, then tighten the screw.

The amount of thread wound on the bobbin is regulated by the screw (B). To wind more thread on the bobbin, turn the screw (B) inwardly. To wind less thread on the bobbin, turn this screw outwardly.

Bobbins can be wound while the machine is stitching.

To Thread the Bobbin Case Caps

Machine 112w116

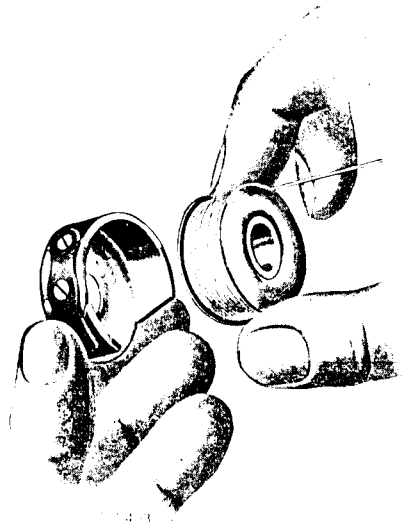

Fig. 6

With the left hand hold the bobbin case cap as illustrated (see Fig. 6), and place the bobbin into it.

Hold the bobbin between the thumb and forefinger of the right hand, the thread drawing on top from the left toward the right.

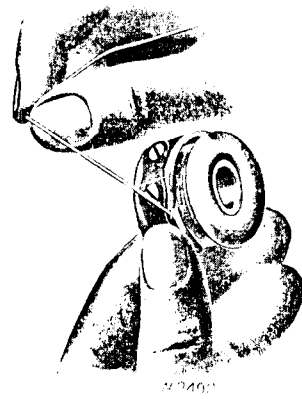

Fig. 7

Then pull the thread into the slot in the edge of the bobbin case cap (see Fig. 7), and under the tension spring as shown in Fig. 8.

To ensure the correct tension, draw the thread under the tension spring once or twice; this will remove any lint which may become lodged under the spring.

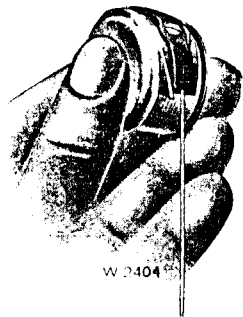

Fig. 8

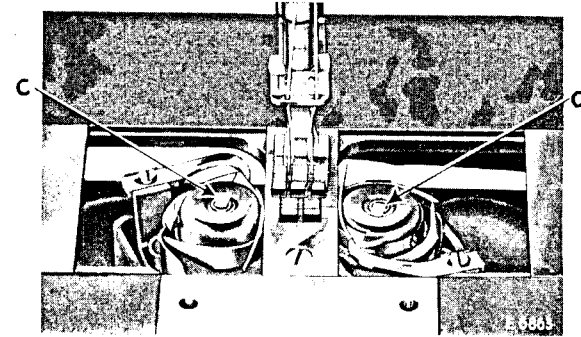

Fig. 9. Bobbin Case Caps Threaded and Replaced

To replace the bobbin case cap at the right of the needles, after threading, take the cap in the right hand, holding the bobbin in the cap with the thumb and replace it on the centre stud, then push down the latch (C, Fig. 9), having the thread at the left of the projection as shown in Fig. 9, and replace the slide plate.

To replace the left bobbin case cap, after threading, take the cap in the left hand, holding the bobbin in the cap with the thumb and place it on the centre stud of the left bobbin case, then push down the latch (C, Fig. 9), having the thread at the right of the projection as shown in Fig. 9, and replace the slide plate.

To Replace the Bobbins and Thread the Bobbin Cases

Machines 112w120 and 113w110

The following instructions apply to both bobbins:

Hold the bobbin between the thumb and forefinger of the left hand, the thread drawing on top from the right toward the left (see Fig. 10), and place it on the centre stud of the bobbin case, then push down the latch as shown in Fig. 11. Draw the thread into the slot (1, Fig. 11) and back of the projection (2, Fig. 12), leaving a loose end of thread about two inches long above the slide. When closing the slides, leave just enough space for the threads to pass through.

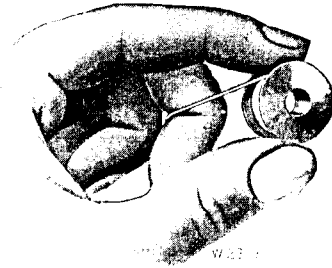

Fig. 10. Direction of Thread on Bobbin

Always oil the bobbin case bearings in the hook races each time a bobbin is replaced.

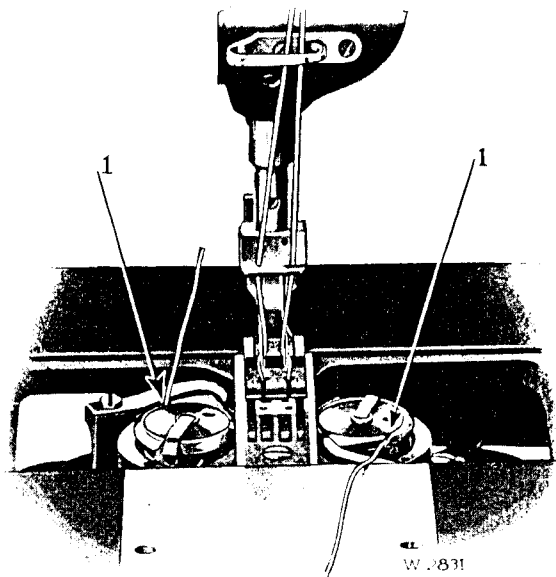

Fig. 11. Threading the Bobbin Cases

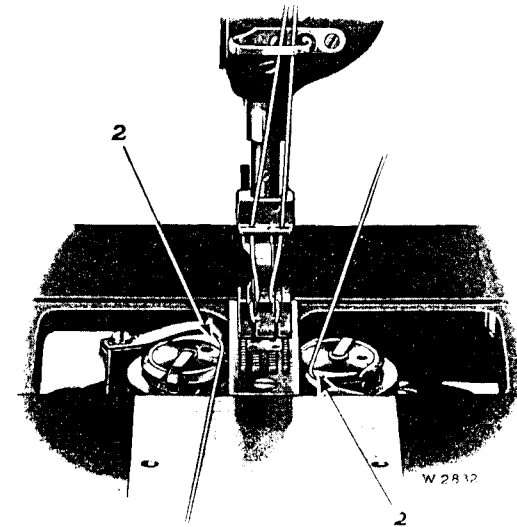

Fig. 12. Threading the Bobbin Cases

To Thread the Needles

(See Fig. 13 on the Following Page)

To thread the outside needle or the one farthest from the upright part of the arm, pass the thread from the left spool on the spool stand, through the left guide at the top of the spool stand, down and from back to front through the hole (1) in the pin on top of the machine, then from right to left through the hole (2) in the pin, into the wire thread guide (3) at the right of the upper thread retainer, through the upper thread retainer (4), over from right to left between the left tension discs (5), down under from right to left around the thread controller (6), into the thread controller spring (7) and up through the thread guide (8), up and from right to left through the upper hole (9) in the end of the thread take-up lever, down through the thread guide (8) again and through the thread guide (11), down through the left hole (12) in the needle holder and from right to left through the eye of the left or outside needle (13).

To thread the inside needle, or the one nearest the upright part of the arm, pass the thread from the right spool on the spool

stand, through the right guide at the top of the spool stand, down, and from back to front through the hole (A) in the pin on top of

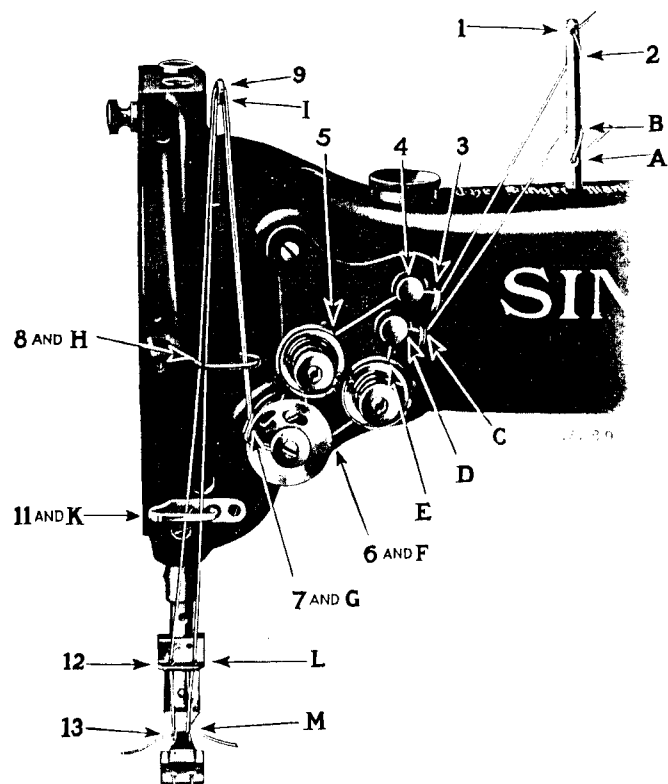

Fig. 13. Threading the Needles

the machine, then up and from right to left through the hole (B) in the pin, into the wire thread guide (C) at the right of the lower thread retainer, through the lower thread retainer (D), under from right to left between the right tension discs (E), down under from right to left around the thread controller (F), into the thread controller spring (G) and up through the thread guide (H), up and from right to left through the lower hole (I) in the end of the thread take-up lever, down through the thread guide (H) again and through the thread guide (K), down through the right hole (L) in the needle holder and from left to right through the eye of the right or inside needle (M).

To Prepare for Sewing

With the left hand hold the ends of the needle threads, leaving them slack from the hand to the needles. Turn the balance wheel

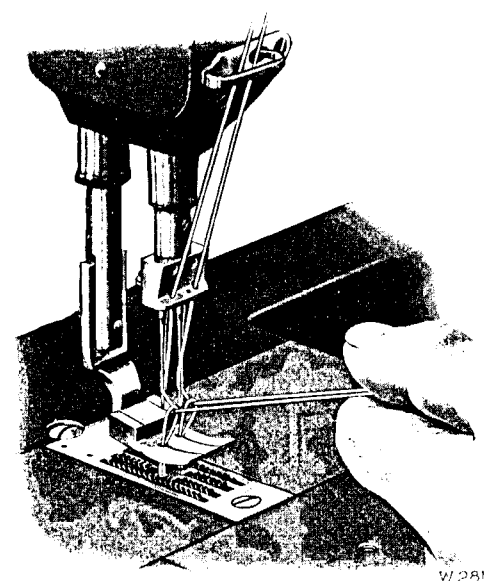

Fig. 14. Drawing Up the Bobbin Threads

over toward you until the needles move down and up again to their highest point, thus catching the bobbin threads; draw up the needle threads and the bobbin threads will come up with them through the holes in the throat plate (see Fig. 14). Lay the threads back under the presser foot and close the slides.

To Commence Sewing

Place the material beneath the presser foot, lower the presser foot and commence to sew, turning the balance wheel over toward you.

To Remove the Work

Have the thread take-up lever at the highest point, raise the presser foot, draw the work back and cut the threads close to the goods. Lay the ends of the threads back under the presser foot.

Tensions

The needle and bobbin threads should be locked in the centre of the thickness of the material, thus :



Fig. 15. Perfect Stitch

If the tension on the needle thread is too tight, or if that on the bobbin thread is too loose, the needle thread will lie straight along the upper surface of the material, thus :



Fig. 16. Tight Needle Thread Tension

If the tension on the bobbin thread is too tight, or if that on the needle thread is too loose, the bobbin thread will lie straight along the under side of the material, thus :



Fig. 17. Loose Needle Thread Tension

To Regulate the Tensions

The tensions on the needle threads are regulated by the thumb nuts (P, Fig. 23) at the front of the tension discs on the front of the machine. To increase the tension, turn these thumb nuts over to the right. To decrease the tension, turn these thumb nuts over to the left.

The tensions on the bobbin threads are regulated by means of the screw nearest the centre of the tension spring on the outside of each bobbin case. To increase the tension, turn these screws over to the right. To decrease the tension, turn these screws over to the left.

To Regulate the Length of Stitch

The length of stitch is regulated by the thumb screw (A, Fig. 18) at the right of the balance wheel.

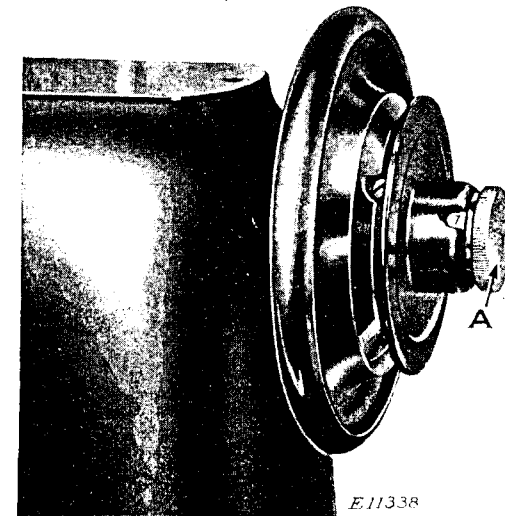

Fig. 18. Stitch Regulator

There is a notch in the hub of the balance wheel as shown in Fig. 18, and the number appearing in the notch shows the number of stitches to the inch that the machine is ready to make.

To lengthen the stitch, turn the thumb screw (A) over toward you. To shorten the stitch, turn this thumb screw over from you.

Note: For the adjustment of the puller feed on Machines 112w116 and 113w110, see pages 25 and 26.

To Regulate the Pressure on Material

The pressure on the material is regulated by the thumb screw (D, Fig. 21) at the back of the machine, the screw acting on a flat spring. To increase the pressure, turn this screw downwardly. To decrease the pressure, turn this screw upwardly. The pressure should be only heavy enough to enable the feed to move the work along evenly.

To Oil the Machine

To ensure easy running and prevent unnecessary wear of the parts which are in movable contact, the machine requires oiling, and when in continuous use, it should be oiled at least twice each day.

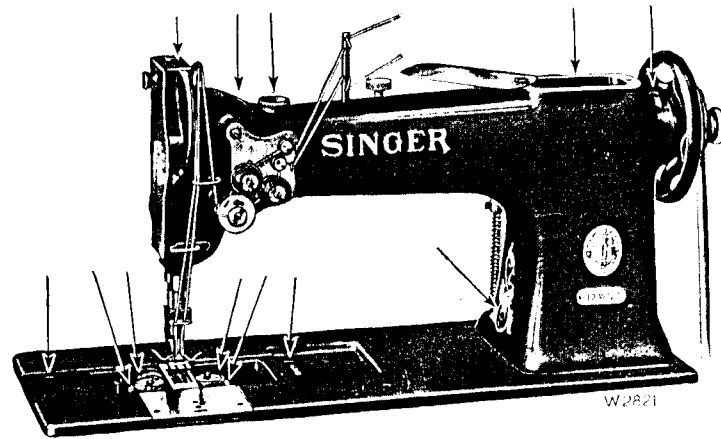

Fig. 19. Oiling Points at the Front of the Machine

Oil should be applied at the places designated by arrows as shown in Figs. 19, 20, 21 and 22. Swing back the cover which is on the top of the machine at the right, and oil the bearings which are thus uncovered, then replace the cover.

Loosen the thumb screw in the upper end of the face plate, turn the face plate upward and oil the wick and bearings which

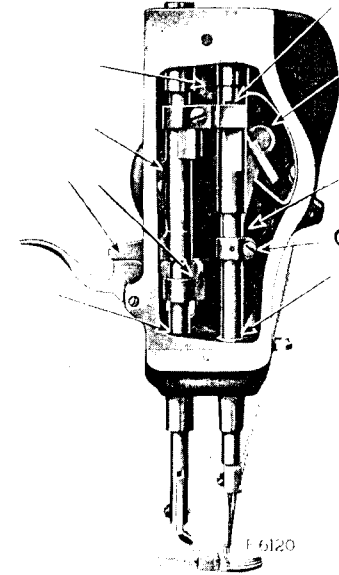

Fig. 20. End View of Machine, Showing Oiling Points

are thus uncovered, then turn down the face plate and tighten the thumb screw.

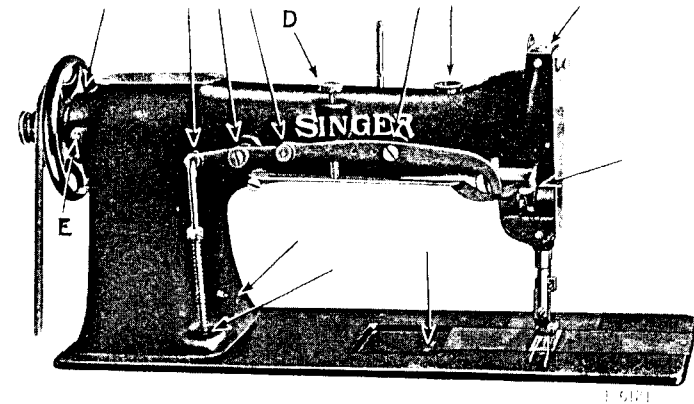

Fig. 21. Oiling Points at the Back of the Machine

Turn the machine back on its hinges and apply oil at the places designated by arrows as shown in Fig. 22, and all other

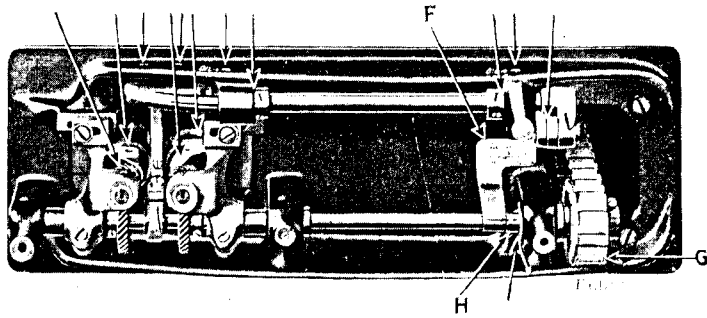

Fig. 22. Base of Machine, Showing Oiling Points

places where there are parts in movable contact, then bring the machine forward into place.

Oil the bobbin case bearings in the hook races each time a bobbin is replaced.

INSTRUCTIONS FOR ADJUSTERS AND MACHINISTS

Thread Controller

The function of the thread controller spring is to hold back the slack of the needle threads until the eye of each needle reaches the goods in its descent, as without this controlling action of the spring, the slack thread or silk (more especially silk) will sometimes be penetrated by the points of the needles as the needles are descending.

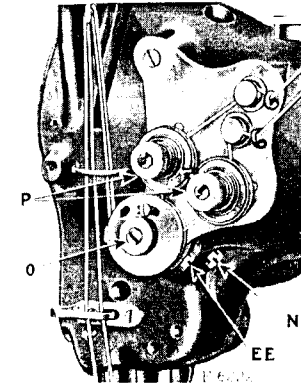

Fig. 23. Adjustment of Thread Controller

To change the thread controller stop for more controller action on the thread, loosen the set screw (EE, Fig. 23) and rotate the thread controller spring stop to the right; for less action, rotate to the left, after which securely tighten the set screw (EE).

It may be found advisable to increase the tension of the spring for coarse thread, or to lessen it for fine thread.

To increase the tension of the thread controller on the threads, loosen the tension stud set screw (N, Fig. 23), located nearly under the tension stud, and turn the tension stud (O, Fig. 23) slightly to the left with a screwdriver, or to decrease the tension, turn it to the right and retighten the stud set screw (N).

To Set the Needle Bar

See that the needles are up in the bar as far as they will go. There are two lines across the needle bar about two inches above the lower end. When the needle bar is at its lowest position, the upper mark should be just visible at the bottom of the needle bar bushing.

In case the needle bar is not correctly timed, loosen the needle bar connecting stud pinch screw (C, Fig. 20) and place the needle bar in the correct position as directed above, then retighten the screw (C).

To Set a Needle Bar which has no Mark. Set the needle bar so that when it rises $\frac{3}{32}$ inch from its lowest position, the points of the sewing hooks will be at the centre of the needles and about $\frac{1}{16}$ inch above the eye.

Relative Positions of Needle Bar and Presser Bar on Machine 112 w 115

The distance between the needle bar and presser bar, after turning the feed regulating spindle head so that there is no feed movement, should be $\frac{1}{2}$ inch.

If the distance between the needle and presser bars is more or less than $\frac{1}{2}$ inch, insert a screwdriver in the hole at the rear of the machine in the upright part of the arm and loosen the screw therein. While this screw is loose, the needle bar frame can be moved forward or backward, as may be required, until the distance between the needle and presser bars is $\frac{1}{2}$ inch. A piece of sheet metal $\frac{1}{2}$ inch wide may be used to determine the correct distance. When making this adjustment be sure to see that the feed regulating spindle head is set so that there is no feeding movement. When the adjustment has been made, securely tighten the screw at the rear in the upright part of the arm.

To Time the Sewing Hooks

Remove the throat plate and turn the balance wheel over toward you until the lower mark across the needle bar is just visible at the bottom of the needle bar bushing on the upward stroke of the needle bar. If the needle bar and sewing hooks are correctly timed, the point of each hook will be at the centre of its needle and about $\frac{1}{16}$ inch above the eye.

In case the sewing hooks are not correctly timed, turn the balance wheel over toward you until the needle bar has descended to its lowest point and has risen until the lower timing mark across the needle bar is just visible at the bottom of the needle bar bushing. Then loosen the four screws (T, Fig. 24) in the hook shaft gears and turn the sewing hooks until the point of each

hook is at the centre of its needle, after which securely tighten the four screws (T), leaving just enough end play to the shaft for lubricating purposes.

To Set the Sewing Hooks To or From the Needles on Machines 112 w 116 and 112 w 120

To prevent the points of the hooks from dividing the strands of the threads, they should run as close to the needles (within the scarf) as possible.

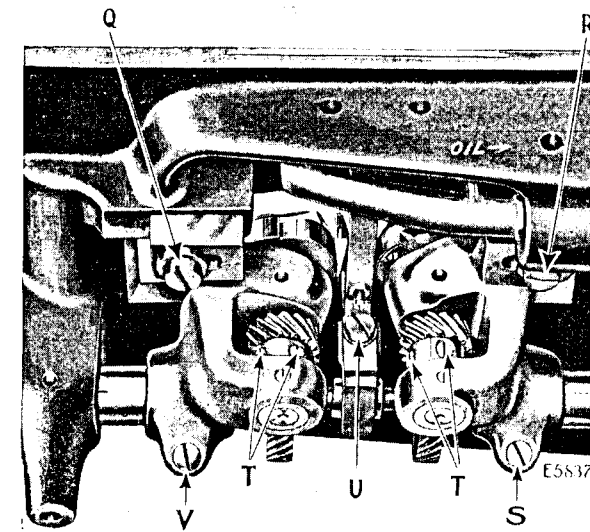

Fig. 24. Adjustment of Hook Saddles on Machines 112w116 and 112w120

Turn the balance wheel over toward you until the points of the sewing hooks are at the centre of the needles. Loosen the four screws (Q, R, S and V, Fig. 24) underneath the bed of the machine, and move the hook saddles to the right or left, as may be required, until the points of hooks are as close to the needles as possible without striking them, then securely tighten the four screws (Q, R, S and V).

The needle guard washer (AA, Fig. 27) which is attached to the bottom of each sewing hook, should be sprung until it prevents the needles from striking the hooks in case the needles are deflected towards the hooks.

To Set the Sewing Hooks To or From the Needles on Machine 113 w 110

To prevent the points of the hooks from dividing the strands of the threads, they should run as close to the needles (within the scarf) as possible.

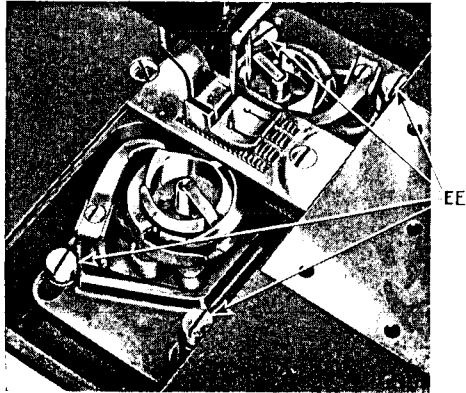

Fig. 25. Adjustment of Hook Saddles
on Machine 113w110

Turn the balance wheel over toward you until the points of the sewing hooks are at the centre of the needles. Loosen the four screws (EE, Fig. 25) in the bed of the machine, and move the hook saddles to the right or left, as may be required, until the points of the hooks are as close to the needles as possible without striking them, then securely tighten the four screws (EE).

The needle guard washer (AA, Fig. 27) which is attached to the bottom of each sewing hook, should be sprung until it prevents the needles from striking the hooks in case the needles are deflected towards the hooks.

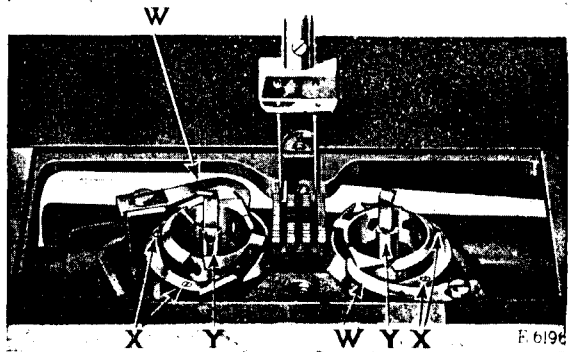

Fig. 26. Removing Bobbin Cases

To Remove the Bobbin Cases from the Sewing Hooks

Remove the four hook gib screws (X, Fig. 26) from the sewing hooks, lift off the hook gibs (Z, Fig. 27) and remove the bobbin cases (Y, Fig. 26).

To Remove the Sewing Hooks from the Machine

Remove the throat plate, feed dog and the two bobbin case opening levers (W, Fig. 26). Also remove the bobbin cases as instructed above, then take out the four screws (T, Fig. 24) from the hook shaft gears and lift out the sewing hooks.

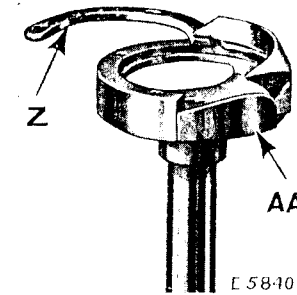

Fig. 27. Sewing Hook Removed from Machine
Showing Hook Washer

To Raise or Lower the Feed Dog

Usually when the feed dog is at its highest position, it should show a full tooth above the throat plate.

Remove the throat plate; clean the lint and dust from between the feed points and replace the throat plate; tip the machine back and turn the balance wheel towards you until the feed dog is at its highest position; loosen screw (U, Fig. 24) in the feed lifting cam fork and raise or lower the feed dog, as may be required, and retighten the screw (U).

When raising or lowering the feed dog, be careful that it does not drop low enough to strike the sewing hooks.

Adjustment of Feed Regulating Spindle Head

The figures on the feed regulating spindle head (DD, Fig. 28), showing through the notch in the balance wheel, indicate

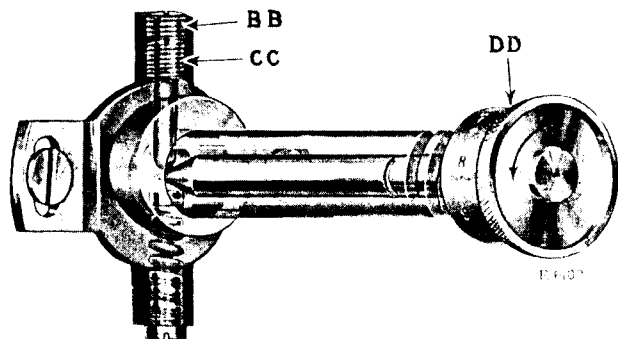

Fig. 28. "X-Ray" View of Feed Driving Eccentric, Regulating Bracket and Shaft, Showing the Feed Regulating Spindle and Adjusting Screw (CC) which Comes in Contact with the Cone of the Spindle to Gauge the Length of Stitch

the number of stitches to the inch which should be made. If more or less stitches are made, adjust as follows: Remove screw (BB, Fig. 28), set the indicator at 8 and the feed dog at its highest point, a full tooth showing above the throat plate, then adjust screw (CC, Fig. 28) until eight stitches to the inch is the result and replace check screw (BB) firmly.

By making this adjustment with the stitch indicator at 8 stitches, the full range of the stitch regulator is automatically taken care of so that the number appearing in the notch in the balance wheel will always indicate the correct number of stitches to the inch that the machine is ready to make.

To Set the Feed Regulator so that a Stitch Longer than the One Desired Cannot be Made. Turn the spindle head (DD, Fig. 28) as far as possible in the direction indicated by the arrow in Fig. 28; remove check screw (BB) and turn screw (CC) until the machine makes the desired number of stitches to the inch, then turn screw (BB) down tightly on screw (CC) as a check. The stitches may then be changed by turning the stitch regulator (DD) for shorter stitches, but operators cannot make a longer stitch than that limited by the above adjustment.

To Adjust the Puller Feed on Machines 112w116 and 113w110

(See Fig. 29)

The puller feed should be adjusted to feed the material slightly faster than the drop feed of the machine, so that the pulling action of the feed rolls will cause a slight tension on the material between the drop feed and the puller feed rolls.

The speed of the puller feed is changed by moving the end of the connection (A) which is fastened by the hexagon nut (C)

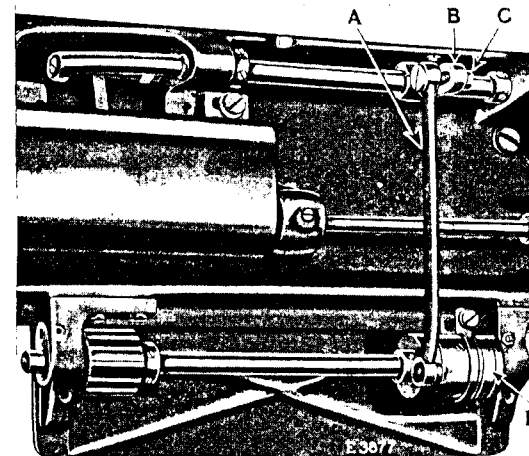

Fig. 29. Showing Adjustment for Changing Speed of Puller Feed

in the slotted segment (B) on the underside of the bed of the machine. To increase the speed of the puller feed, loosen the hexagon nut (C) and move the connection (A) in the slotted segment away from the shaft. To decrease the speed of the puller feed, move the connection (A) toward the shaft. When the required speed of the feed roll is obtained, firmly tighten the hexagon nut (C).

When the puller feed is once correctly set, it seldom requires attention, as the adjustment for changes in length of stitch is automatically taken care of by the stitch regulator of the machine.

If trouble is experienced with clutch slipping, it is probably caused by oil working into clutch assembly (D). Saturate the clutch thoroughly with gasoline or benzine and run the machine a few moments, after which wipe off surplus gasoline, and then place a drop of oil on hinge screw of connection (A).

To Regulate the Pressure on the Upper Feed Roll of Machines 112 w 116 and 113 w 110

(See Fig. 30)

The pressure of the upper feed roll on the material should be only sufficient to enable the feed rolls to pull the material from

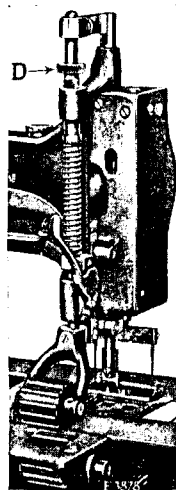

Fig. 30. Adjustment for Regulating Pressure on Upper Feed Roll

the drop feed of the machine without slipping. To increase the pressure on the upper feed roll, turn the thumb screw (D) over to the right or downwardly. To decrease the pressure on the upper feed roll, turn the thumb screw (D) over to the left or upwardly.

Puller Feed Rolls

The two rolls of the puller feed may be either corrugated steel or rubber faced to suit the requirements of the work being sewn.

Following is a list of the corrugated steel rolls which can be furnished, and the classes of work for which they are adapted:

CORRUGATED FEED ROLLS	NO. OF TEETH	CLASS OF WORK
237035 lower (fine)	27	Flags, tents, awnings, balloons and similar work
237036 upper (fine)	27	
237017 lower (coarse)	13	For banding overalls and pants
237020 upper (coarse)	13	
237017 lower (coarse)	13	Comfortables and thick work generally
237045 upper (coarse)	13	

The Rubber Faced Feed Rolls are 237038 (lower) and 237039 (upper). These rolls are used when stitching handkerchiefs and other articles on which it is desirable not to show the marks of the corrugated steel puller feed rolls on either side of the material.

The combination of Rubber Faced Feed Roll 237039 (upper) and Corrugated Steel Feed Roll 237035 (lower) is found most satisfactory for automobile curtains and similar materials which are easily marked on the upper side, but on the underside of which a corrugated steel roll can be used.

To Remove the Arm Shaft Connection Belt from Within the Arm

Slide the connecting belt off the lower pulley (G, Fig. 22); remove the feed regulating spindle head and balance wheel; loosen the arm shaft bushing (back) screw (E, Fig. 21) at the back of the arm and remove the bushing; lift the belt up through the arm cap hole as far as possible and draw it out through the space normally occupied by the bushing.

Owing to the fact that the sewing hooks make two revolutions to one revolution of the arm shaft, and that the feed lifting eccentric is on the hook shaft, it is possible to have the sewing hooks correctly timed without having the feed eccentric correctly timed. To overcome this, the plate (F, Fig. 22) is attached to the underside of the bed of the machine. This plate is marked with an arrow at its lower end and directly alongside of the plate is the collar (H, Fig. 22) mounted on the hook shaft, which is also marked with an arrow. When replacing the belt, replace the arm shaft bushing and securely fasten it in position by the screw (E, Fig. 21) at the back of the machine; replace the feed regulating spindle head and the balance wheel, and place the belt on the upper pulley, and then turn the balance wheel over toward you until the thread take-up lever is at its highest point. Then turn the hook shaft with the fingers until the two arrows, one on plate "F" and the other on collar "H", are directly in line. Now, without disturbing either the arm shaft or the hook shaft, slip the belt over the lower pulley (G, Fig. 22). The feed will then be correctly timed with the needle bar.

To facilitate the replacing of the belt on the lower pulley, use belt replacer 241538 (A, Fig. 31). Rest the replacer in the

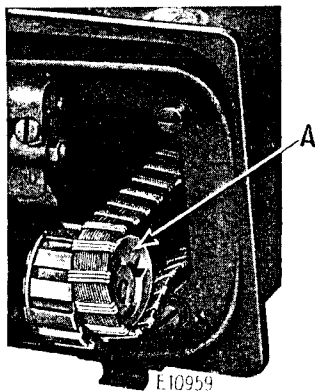

Fig. 31. Putting Belt on Lower Pulley with Belt Replacer 241538

loop of the belt and slide it over the hub of the pulley, as shown in Fig. 31, having the notches in the replacer engage the two set screws in the hub of the pulley. Turn the balance wheel toward you until the belt is fully over the pulley, then remove the replacer.

Note: As belt replacer 241538 will serve for several machines, it is not regularly furnished with the machine, and must be ordered separately.

**Genuine Singer Needles should be used
in Singer Machines.
These Needles and their Containers
are marked with the
Company's Trade Mark "SIMANCO." 1**

**Needles in Containers marked
"For Singer Machines"
are not Singer made needles. 2**