

SINGER

81-50,-52,-53,-56,-63

USE ONLY
SINGER

"MANUFACTURING SEWING MACHINE OIL

(Cloth and Leather)"

for general use

or

"MANUFACTURING SEWING MACHINE OIL

(Stainless for White Goods)"

where a stainless oil is desired.

These specially prepared oils are the result of extensive research. They ensure freedom from lubricating trouble and give longer life to sewing machines.

**THE IMPORTANCE OF USING
SINGER NEEDLES FOR
SEWING MACHINES**

The best stitching results will be obtained by using the needles furnished by the Singer Sewing Machine Company.

Singer Needles can be purchased from any Singer Shop for the Manufacturing Trade.

Genuine Singer Needles should be used
in Singer Machines.
These Needles and their Containers
are marked with the
Company's Trade Mark "SIMANCO." 1

Needles in Containers marked
"For Singer Machines"
are not Singer made needles. 2

Copyright, U. S. A., 1926, 1932, 1933 and 1935,
by The Singer Manufacturing Company
All Rights Reserved for all Countries

18675

To all whom it may concern:

The placing or renewal of the name "Singer" (Reg. U. S. Pat. Off.) or any of the trade marks of The Singer Manufacturing Company on any machine that has been repaired, rebuilt, reconditioned or altered in any way whatsoever outside a Singer factory or an authorized Singer agency is forbidden.

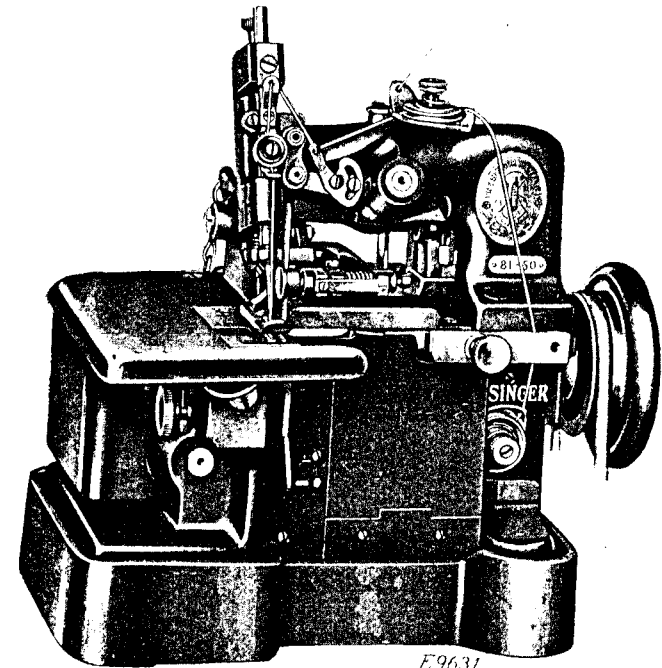

**INSTRUCTIONS FOR
ASSEMBLING AND ADJUSTING MECHANISM
AND
REPLACING LUBRICATING WICKS
OF HIGH SPEED MACHINES 81-50, 81-52,
81-53, 81-56 AND 81-63**

NOTE

When inferior oil is used or when the oil is dirty, absorption of the oil by the wicks may be interfered with and the consequent lack of supply of oil for the lubrication of the bearings will cause serious trouble.

Use either "Singer Manufacturing Sewing Machine Oil (Stainless for White Goods)" or "Singer Manufacturing Sewing Machine Oil (Cloth and Leather)" for the lubrication of these machines.

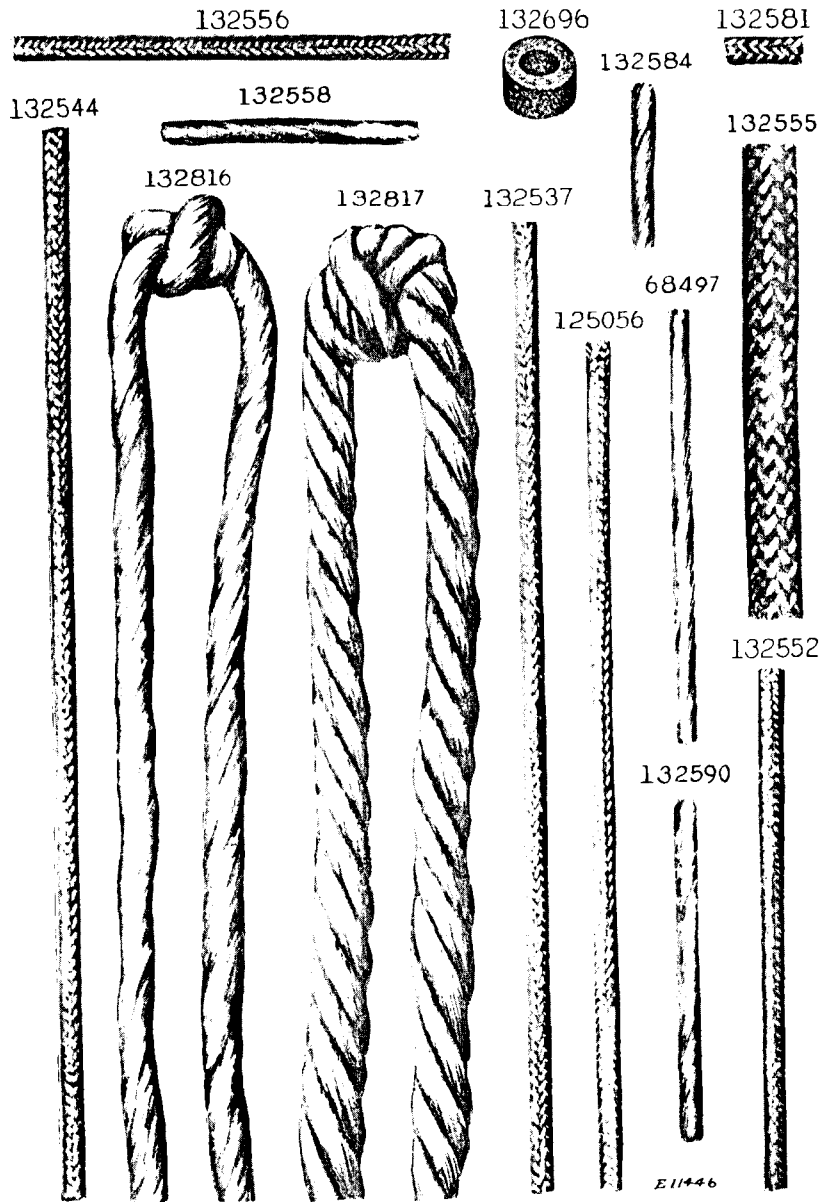

FIG. 2
WICKS USED IN MACHINES
(ILLUSTRATIONS ACTUAL SIZE)

Charts Showing Distribution of Oil

Primary wicks, solid red; secondary wicks, sectional red lines; channels or ducts, two red lines.

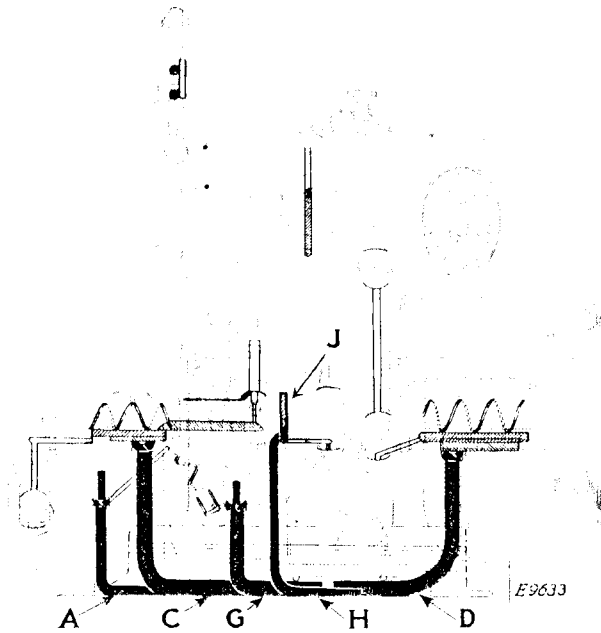

FIG. 3
SECTIONAL VIEW OF FRONT OF MACHINE

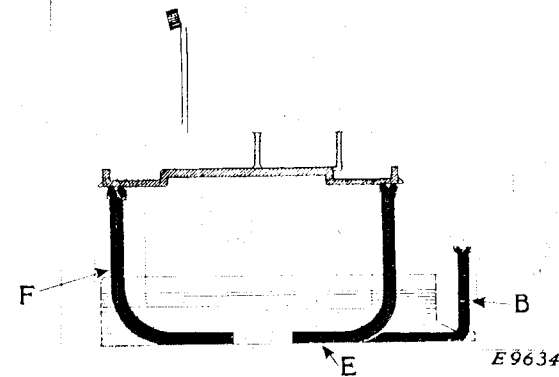

FIG. 4
SECTIONAL VIEW OF REAR OF MACHINE

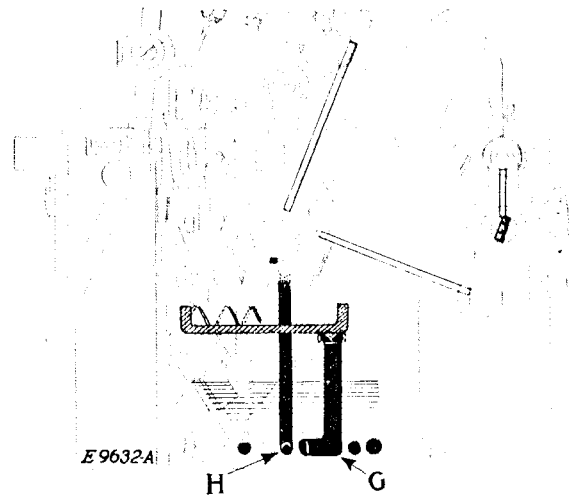

FIG. 5
SECTIONAL VIEW OF RIGHT END OF MACHINE

Primary Wicks

One end of each of the eight primary wicks (A, B, C, D, E, F, G and H, Figs. 3, 4, 5 and 6) lies on the bottom of the oil reservoir of the machine and the other end of each of these wicks extends up through the casting. The upper end of each, except H, is formed into a knot which is anchored in a countersunk hole to hold the wick in position. The upper end of wick H is secured in the feed eccentric lubricator shown at J, Fig. 3 and A, Fig. 27.

Each primary wick takes the oil from the reservoir up to the secondary wicks.

Removal of Bottom Cover of Machine

Before removing the bottom cover from the machine, drain the oil through the oil tube in the base of the machine, then tilt the machine back and loosen the screws which hold the bottom cover in position. This will allow the remainder of the oil in the reservoir to drain off.

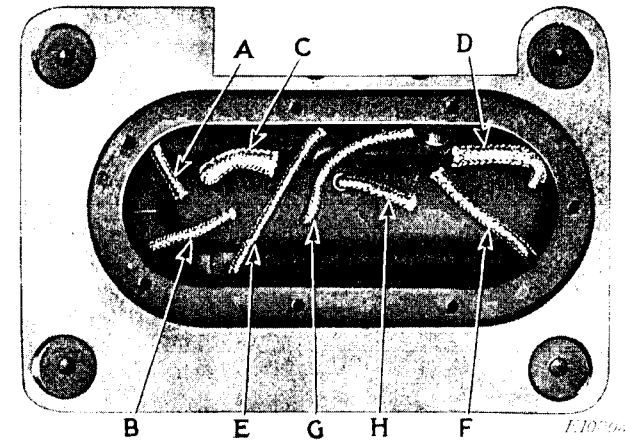

FIG. 6
UNDERSIDE OF MACHINE AFTER REMOVAL OF BOTTOM
COVER SHOWING PRIMARY WICKS IN POSITION

Primary Replacement Wicks

- Wick A, 132816, leads to right hand looper and spreader lever hinge pin (front of machine).
- Wick B, 132816, leads to right hand looper and spreader lever hinge pin (rear of machine).
- Wick C, 132817, leads to frame rotary shaft bushing (left).
- Wick D, 132817, leads to frame rotary shaft flanged bushing (right).
- Wick E, 132816, leads to feed rock shaft hinge pin (left).
- Wick F, 132816, leads to feed rock shaft hinge pin (right).
- Wick G, 132816, leads to left hand looper lever hinge stud.
- Wick H, 132537, leads to feed eccentric lubricator.

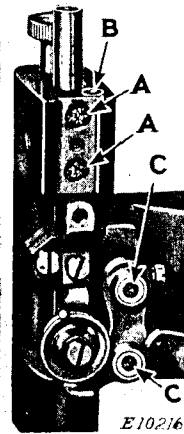

FIG. 7

LUBRICATION OF NEEDLE BAR BUSHING AND LINKS

The needle bar in its bushing is lubricated by two oil wicks (AA) (132581), a channel connecting the two and for these, oil is applied by hand through the oil hole (B) at the top of the arm.

The two wicks (CC) (132584) oiled by hand, supply oil for the needle bar connecting link hinge pins.

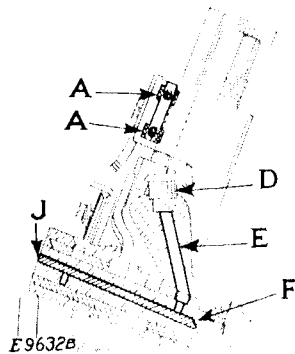

FIG. 8

LUBRICATION OF NEEDLE BAR CRANK

Oil applied by hand to the oil cup (D) travels through the channel (E) to the bushing (F). A hole in the bushing conducts the oil to the wick (J) (132590) which lubricates the needle bar crank pin.

To Disassemble the Machine

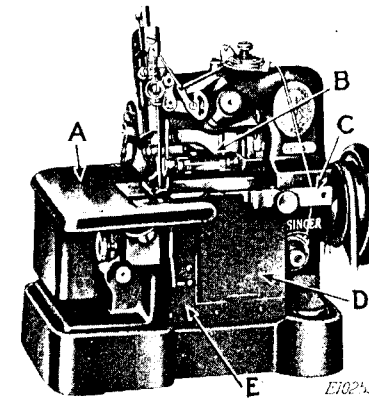

FIG. 9

Remove needle, presser foot, throat plate, feed dog, upper knife, cloth plate (A), frame top cover (B), frame top cover extension (C), hinged frame cover (D) and frame side cover (E).

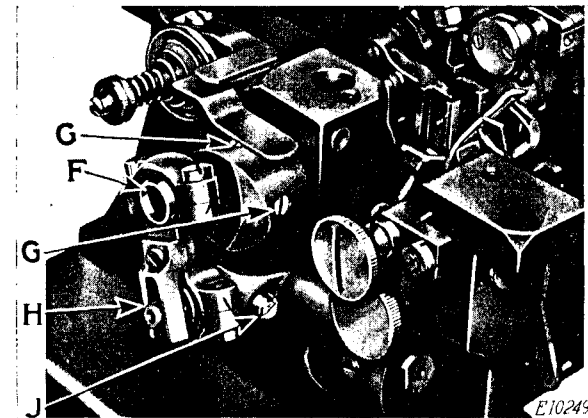

FIG. 10. DISASSEMBLY

Remove right and left loopers, tension complete and thread nippers. Remove frame rotary shaft crank (F) complete with guide (H) after loosening the two screws (GG) and the screw (J).

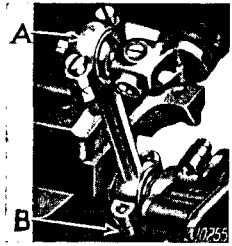

FIG. 11
REMOVAL OF NEEDLE
BAR CONNECTING ROD

Remove the upper connecting rod cap (A) and the lower connecting rod cap (B). After the removal of the connecting rod and its two caps, temporarily assemble them to ensure correct assembly later. Note the slight groove at one side of each cap and connecting rod for matching.

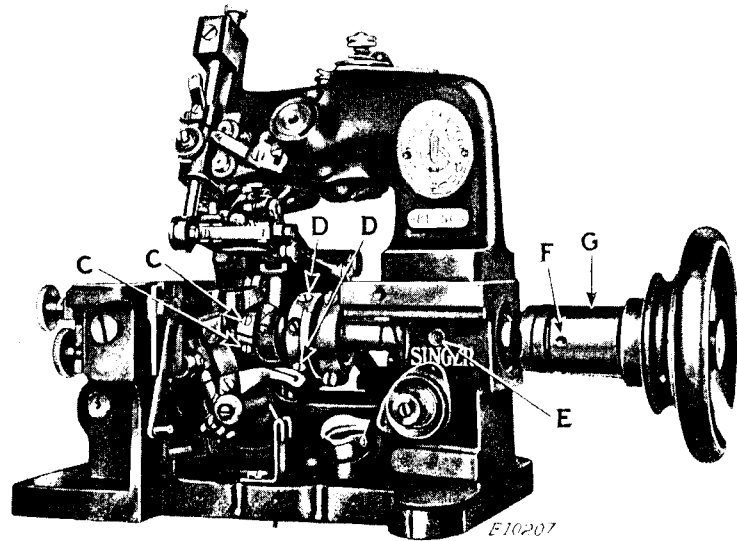

FIG. 12
REMOVAL OF FRAME ROTARY SHAFT

Loosen the two set screws (CC) in feed lifting eccentric, loosen the two small set screws (DD) in feed eccentric (the two larger screws are used for regulating the length of feed). Take out the tip set screw indicated at E. Turn the shaft so that the ball of the crank will pass through the clearance in the casting (A, Fig. 30). Tap gently with a mallet at the left end of the shaft and withdraw the shaft with balance wheel and bushing (G) as shown above.

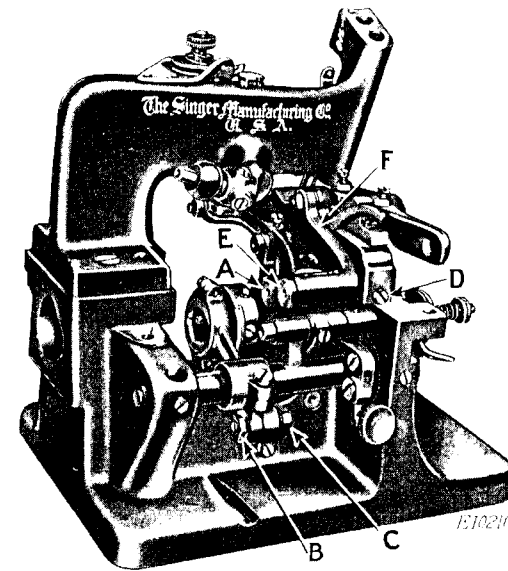

FIG. 13.
REMOVAL OF FEED ECCENTRIC

Take off nut (B) and remove screw (C). Remove connecting rod and feed eccentric in one unit. Remove the feed eccentric lubricator (A, Fig. 27).

Loosen set screw (D) and after taking out hinge pin (E), remove the presser lever (F).

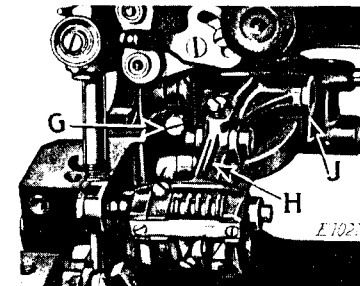

FIG. 14
REMOVAL OF KNIFE LEVER

Loosen set screw (G) and after taking out hinge pin (J), remove the knife lever (H) and eccentric in one unit.

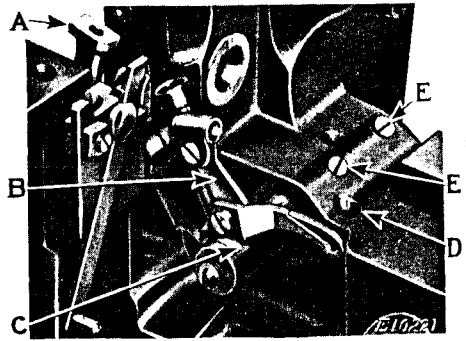

FIG. 15

REMOVAL OF RIGHT AND LEFT LOOPER LEVERS

Loosen set screws (EE) and withdraw left hand looper lever hinge stud (C). Then take out left hand looper lever.

Remove right hand looper lever (A) after loosening set screws (A and E, Fig. 33) and removing hinge pin (H, Fig. 33).

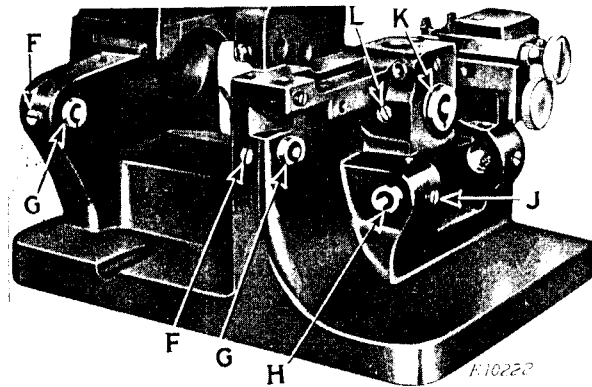

FIG. 16

REMOVAL OF BUSHINGS

Loosen set screws (FF) and remove the split bushings (GG) for feed rock shaft hinge pin. Also loosen set screw (J) and remove the split bushing (H) for right hand looper and spreader lever hinge pin. Remove frame rotary shaft bushing (K) after taking out set screw (L).

Replacing the Wicks

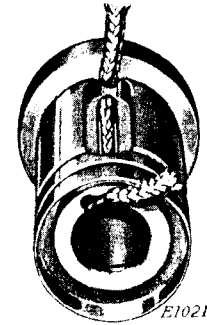

FIG. 17

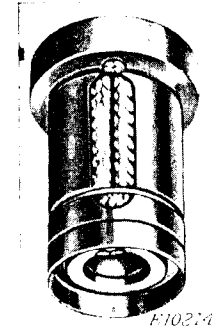

FIG. 18

REPLACING THE WICKS FOR FRAME ROTARY SHAFT FLANGED BUSHING 132554

After putting the wick 132556 down into the slot in the bushing, bring the end through the hole at the right (Fig. 17), then pass the end back through the hole at the left and pack this end back into the recess at the left. Bring the other end of the wick forward and pack it into the recess.

Pack the heavier wick 132555 over the smaller wick as shown (Fig. 18) and snap the wick retainer spring 132603 into place.

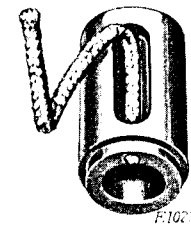

FIG. 19

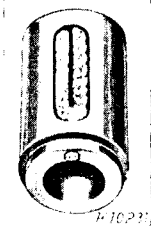

FIG. 20

REPLACING THE WICK FOR FRAME ROTARY SHAFT BUSHING 132550

After putting the wick 132552 down into the slot of the bushing, put the end into the hole (Fig. 19) to secure it and pack the wick into the recess of the bushing as shown (Fig. 20).

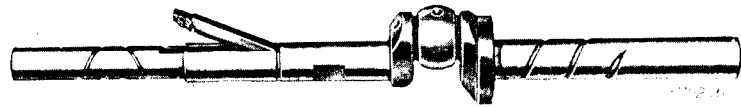

FIG. 21
FRAME ROTARY SHAFT

Fit wick 132558 into its retainer 132559 (Fig. 21) and put both into position in the groove in the shaft and press the retainer down firmly.



FIG. 22
RIGHT HAND LOOPER AND
SPREADER LEVER HINGE PIN 132699



FIG. 23
FEED ECCENTRIC LUBRICATOR
132785

Wick 125056 is threaded in hinge pin 132699, as shown in Fig. 22, one end being positioned in the hole (A) at the left and the other in the hole (B) at the right.

Wick 132537 is threaded in feed eccentric lubricator, as shown in Fig. 23, the upper end of the wick being positioned in the hole in the groove at the right.



FIG. 24
FEED ROCK SHAFT
HINGE PIN 132542



FIG. 25
LEFT HAND LOOPER
LEVER HINGE STUD 132569

Wick 132544 is threaded in hinge pin 132542, as shown in Fig. 24.

Wick 132552 is threaded in hinge stud 132569, as shown in Fig. 25.

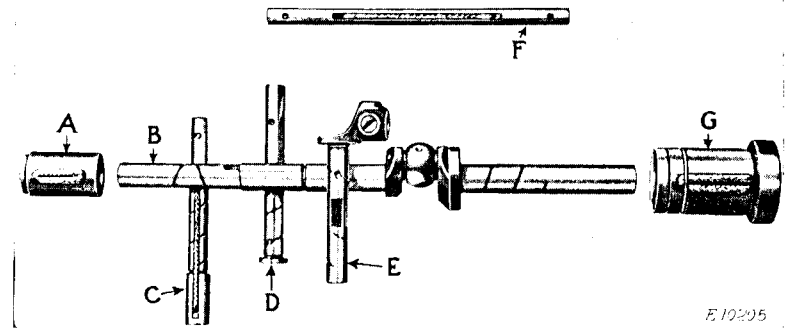

FIG. 26
PINS AND BUSHINGS THREADED WITH WICKS

- A. 132550, frame rotary shaft bushing (front) with wick 132552.
- B. 132549, frame rotary shaft with wick 132558 and retainer 132559.
- C. 132699, right hand looper and spreader lever hinge pin with wick 125056.
- D. 132569, left hand looper lever hinge stud with wick 132552.
- E. 132588, needle bar crank with wick 132590.
- F. 132542, feed rock shaft hinge pin with wick 132544.
- G. 132694, frame rotary shaft flanged bushing with wicks 132555 and 132556, retainer spring 132603 and oil sling cover 132692.

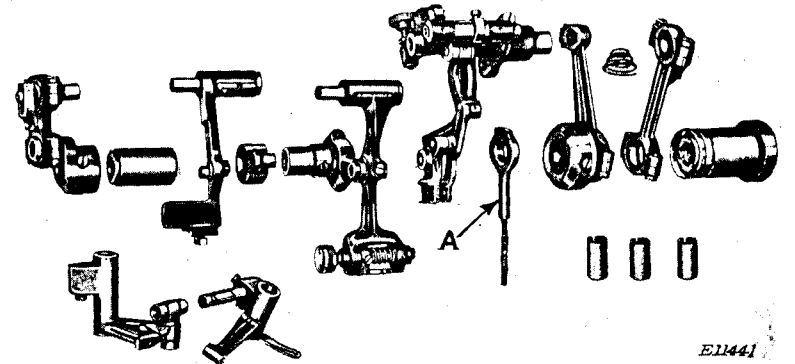

FIG. 27
SOME OF THE UNITS READY FOR ASSEMBLY



FIG. 28

PRIMARY WICK 132817. USED FOR BUSHINGS
AT EACH END OF FRAME ROTARY SHAFT

An overhand knot as shown (Fig. 28), holds this primary wick in place. The knot in the primary wicks must not be made too tight. It should just fill the countersunk space made for it in the bed casting and **must make contact with the secondary wicks to assure the lubrication of the bearings.**

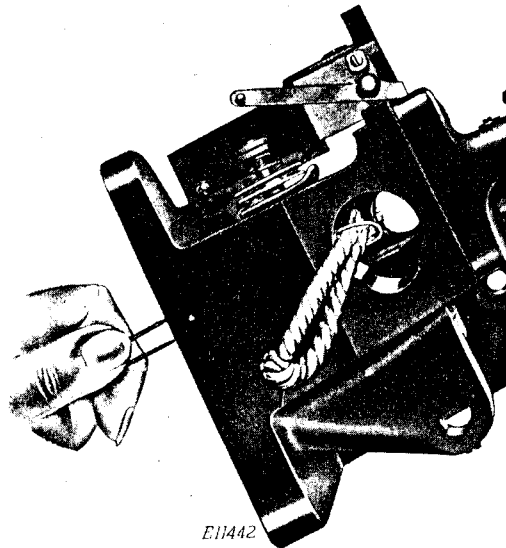

FIG. 29

METHOD OF INSERTING WICKS

After forming a loop with a thin piece of wire or an ordinary piece of twine, the wick is drawn down into place in the hole in the casting as shown (Fig. 29).

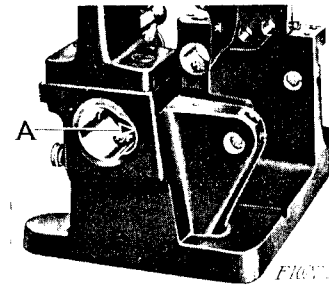

FIG. 30

FOUR OF THE PRIMARY WICKS
DRAWN INTO PLACE

Assembly

Having installed the primary wicks and put the secondary wicks into their respective hinge pins, etc., the parts of the machine are now ready for assembly.

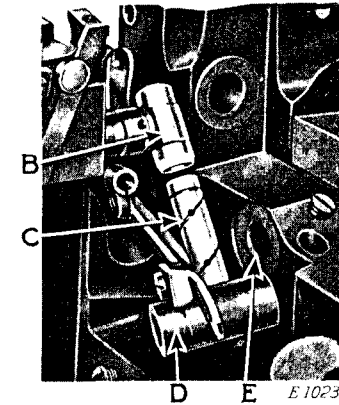

FIG. 31

ASSEMBLY OF LOOPER LEVERS

Place the right hand lever connecting stud (B) with the beveled end downwardly, on the right hand looper lever, as shown, and enter the left hand looper lever connecting stud (C) into the hollow of stud (D). Then insert the hinge stud (Fig. 25) into the bearing (D) of the left hand looper lever and into the hole (E) of the casting, being careful to see that the oil wick in the hinge stud is central at the bottom to make contact with the primary wick (G, Fig. 6). Push the hinge stud (C, Fig. 15) in as far as possible and securely tighten the set screws (EE, Fig. 15) which position on the flat of the hinge stud.

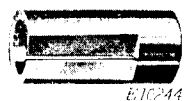

FIG. 32

BUSHING FOR LOOPER LEVER HINGE PIN (ONE)
AND FOR FEED ROCK SHAFT HINGE PIN (TWO)

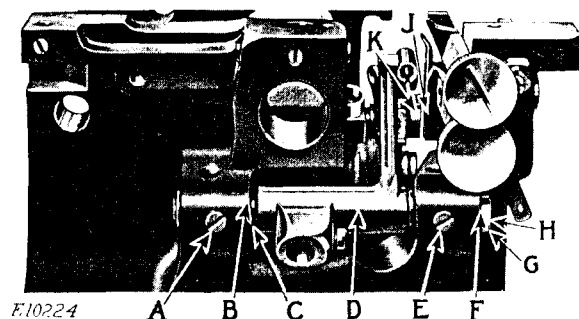

FIG. 33

INSTALLING OF LOOPER LEVERS

Insert the split bushing (Fig. 32) in the hole indicated at (B), putting the flattened end in first from the front of the machine so that the looper lever (D) will bear against the completely rounded end of the bushing. The slot in the bushing must be exactly in the centre at the bottom, so that contact of the wick at the end of the hinge pin (H) will be made, through the slot in the bushing, with the primary wick (B, Fig. 6). Then slightly tighten the set screw (A).

Insert the hinge pin (H) into the hole of the casting indicated at (F) and into the sleeve of the looper lever. Then enter the end of the hinge pin into the bushing (C), having the wick in the pin at the bottom of the split bushing. The flat of the hinge pin shown at (G) will then be in position to receive the set screw (E) and the wick in the shoulder of the hinge pin will be in contact with the primary wick (A, Fig. 6).

Move the looper lever (D) over to the shoulder of the hinge pin and adjust the hinge pin so that the tubular part of the looper lever (K) has a clearance of about $\frac{1}{16}$ inch from the lug of the casting at (J). Then firmly tighten the set screw (E).

Move the split bushing (C) over to the looper lever (D), leaving it free so as not to bind. Then firmly tighten the set screw (A).

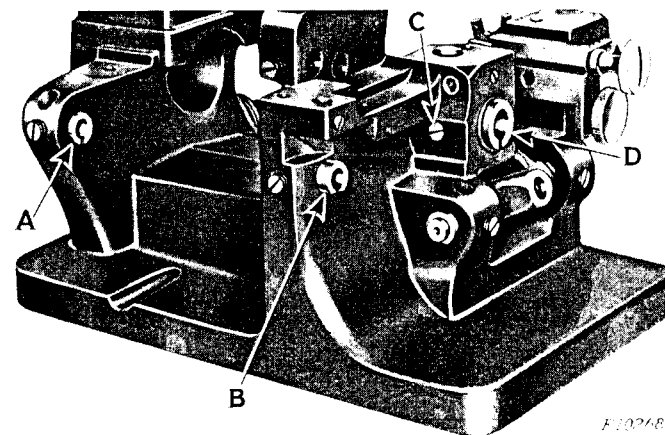

FIG. 34

REPLACING OF BUSHINGS

To replace the two split bushings (A and B) for the feed rock shaft hinge pin: Into the hole at the left, enter the flattened end of the bushing (Fig. 32) in an outward direction (toward the left). Into the hole at the right insert the flattened end of the bushing and push the bushing outwardly (toward the right).

When the feed rock shaft is installed, each of its two bearing ends will bear against the completely rounded ends of each bushing. The slot in each bushing must be exactly in the centre at the bottom so that contact of the wick in the hinge pin of the feed rock shaft will be made through the slot of each bushing with the primary wicks (E and F, Fig. 6).

Replace the front rotary shaft bushing (D), having the wick exactly in the centre at the bottom to make contact with the primary wick (C, Fig. 6). Then locate the hole in the bushing through the tapped hole shown at (C) so that it will receive the tip screw. Insert the screw and firmly tighten it.

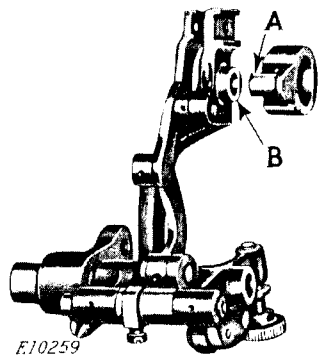

FIG. 35
INSTALLING FEED ROCK SHAFT

When inserting the hinge pin (D, Fig. 36) of the feed rock shaft make sure that the wick at each end of the pin is directly over the slots in the bushings. Then slightly tighten the set screws (E and G).

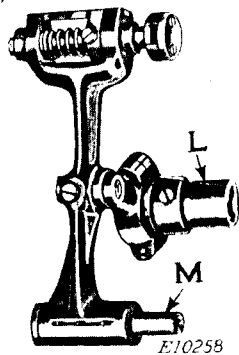

FIG. 37
INSTALLING KNIFE LEVER

Before installing the feed rock shaft which is assembled with other feed parts, as shown in Fig. 35, place the spur (A) of the feed lifting eccentric into the hole of the feed bar at (B).

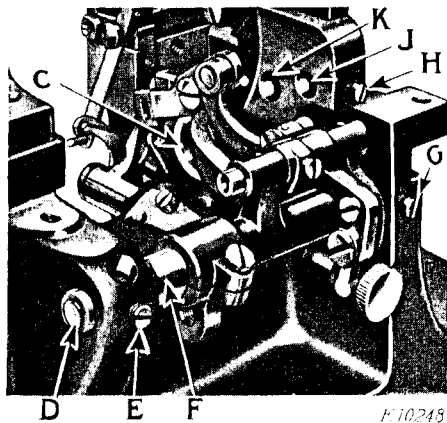

FIG. 36
INSTALLING THE FEEDING MECHANISM

Insert the feed lifting eccentric (L, Fig. 37) into the hole (C, Fig. 36) of the feed lifting eccentric connection and insert the end of the knife lever hinge stud (M, Fig. 37) into the hole (K, Fig. 36) of the casting, having the flat in the hinge stud in position to receive the set screw (G, Fig. 14). Then securely tighten the set screw.

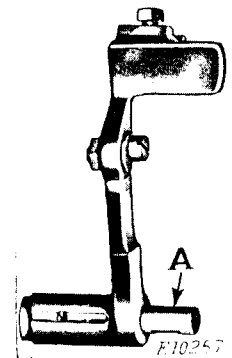

FIG. 38
INSTALLING PRESSER
LEVER

Insert the presser lever hinge stud (A) into the hole (J, Fig. 36) in the casting, having the flat in position to receive the set screw (H, Fig. 36), then firmly tighten the set screw.

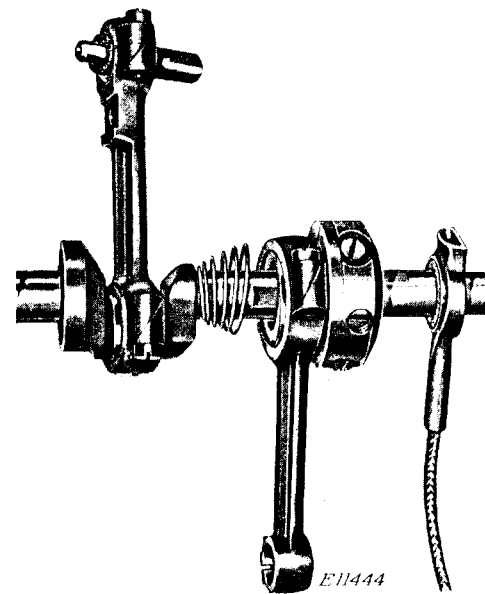

FIG. 39
INSTALLING SPRING, FEED ECCENTRIC
AND FEED ECCENTRIC LUBRICATOR
(VIEW FROM REAR OF MACHINE)

The small diameter of the spring is placed against the frame rotary shaft crank as shown in Fig. 39. The circular ridge of the feed eccentric lubricator fits into the hollow of the feed eccentric. After placing them together, pass the wick down through the hole (D, Fig. 15) and insert the end of the lubricator in the hole.

Installing Frame Rotary Shaft

(SEE PAGE 12)

Having the flanged bushing and balance wheel on the frame rotary shaft, insert the end of the shaft in the hole at the end of the casting, being careful to see that the hole for the end of the tip screw in the flanged bushing is in the position shown at F, Fig. 12.

Turn the shaft so that the ball of the crank will pass through the clearance in the casting (A, Fig. 30). The hole in the flanged bushing for the tip screw can be seen through the tapped hole (E, Fig. 12) in the casting. Insert the tip screw and firmly tighten it.

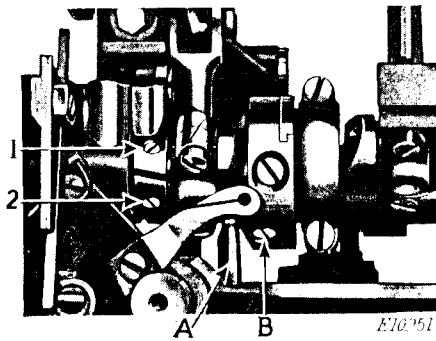

FIG. 40

INSTALLING FRAME ROTARY SHAFT

Turn the balance wheel over from you as in regular operation and remove the first screw (1) in the feed lifting eccentric. Turn the shaft until the flat on the shaft can be seen through the set screw hole, replace and firmly tighten the set screw on the flat. Then firmly tighten the other set screw (2).

Having the two set screws (one of which is designated by B), loose in the feed eccentric, push the feed eccentric lubricator (A) and feed eccentric snugly up against the feed lifting eccentric, making sure that the tube of the feed eccentric lubricator is exactly upright.

Remove the first screw (B) in the feed eccentric and after locating its flat on the shaft, replace this set screw and firmly tighten it. Then tighten the second set screw.

Secure the lower end of the connecting rod of the feed eccentric to the crank of the feed rock shaft with the screw and nut (B and C, Fig. 13).

Installing the Needle Bar Connecting Rod

(SEE FIG. 11)

The two caps (top and bottom) of the needle bar connecting rod are mated with the connecting rod and replaced in this manner. See that the groove at one side of each cap matches with the groove in one side in each end of the connecting rod.

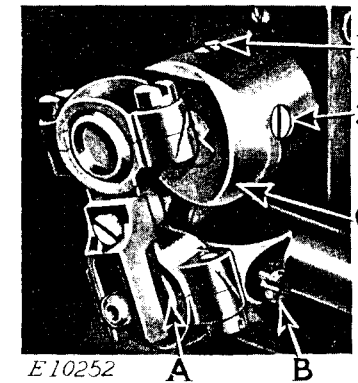

FIG. 41

INSTALLING THE ROTARY SHAFT CRANK

While placing the rotary shaft crank on the end of the shaft, enter the end of the ball stud (A) into the hole in the sleeve of the right hand looper lever. The extent of the insertion of the stud into the hole controls the stroke of the loopers. The rotary shaft crank (C) should be located tightly up against the rotary shaft bushing, but not so tight as to bind.

Turn the shaft until the slot in the end of the shaft is in line with the second screw hole (2) in the rotary shaft crank, then insert the pointed timing screw and firmly tighten it in the slot of the shaft and tighten set screw (1).

Installing of Feed Dog and Throat Plate

(SEE FIG. 36)

After the feed dog is installed, place the throat plate in position. The correct position of the feed dog between the bars of the throat plate is obtained by moving the feed rock shaft (D, Fig. 36) to the right or left as desired. Then bring the bushings on each side close up to the ends of the feed rock shaft bearings and firmly tighten the set screws (E, and G, Fig. 36).

Installing of Loopers, Etc.

(SEE FIG. 10)

Replace the tension complete, thread nippers and right and left hand loopers.

To Complete the Assembly

(SEE FIG. 9)

Replace frame side cover, hinged frame side cover, frame top cover extension, frame top cover, cloth plate, upper knife, presser foot and needle.

Oiling

Use either "Singer Manufacturing Sewing Machine Oil (Stainless for White Goods)" or "Singer Manufacturing Sewing Machine Oil (Cloth and Leather.)"

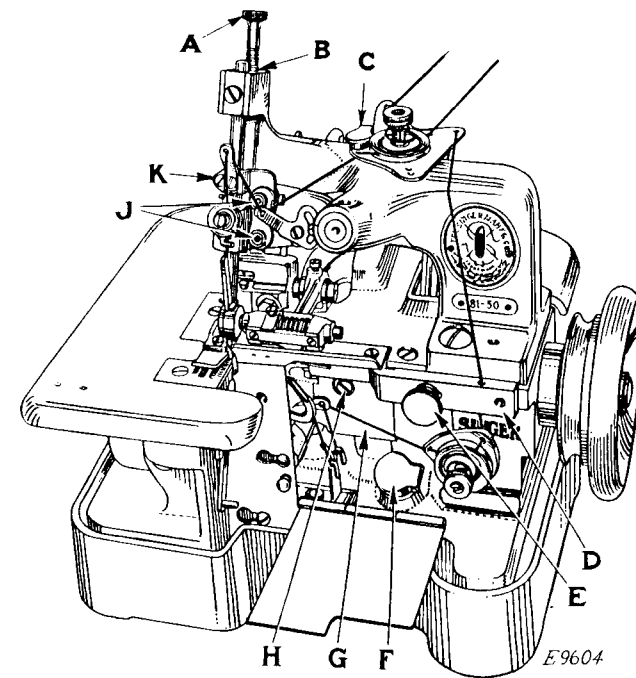

FIG. 42

FRONT VIEW, SHOWING OILING POINTS AND ADJUSTMENTS

Apply the oil to the oil cup (F) in the bed of the machine until the reservoir is full. Also fill the oil cup (C) at the top of the machine and saturate the wicks, through the oil hole at B, which lubricate the needle bar. Oil the needle bar link connection (J) and the knife lever and presser lever bearings at the back of the machine. These oil holes are shown in Figs. 35, 37 and 38.

Thereafter, replenish the oil supply in the reservoir about once each day, or often enough to keep it filled. Twice a day apply oil to the remainder of the oiling points.

“Running-In”

When the machine has been assembled and thoroughly lubricated, it should be carefully “run-in” for about twelve hours, at a speed not exceeding 3000 revolutions per minute, and gradually brought up to the desired speed. The maximum speed is 4500 revolutions per minute for long runs or 5000 for short runs.

Adjustments

To Set the Needle Bar at the Correct Height

Remove the throat plate in order to obtain a clear view of the needle and loopers.

Turn the balance wheel over from you until the needle bar has risen $\frac{3}{32}$ inch from its lowest position. The point of the left hand looper, on its loop taking stroke, should then be at the centre of the needle, and the eye of the needle should be about $\frac{1}{16}$ inch below the looper point. If the needle bar is not at the correct height, loosen the pinch screw (K, Fig. 42) and move the needle bar upward or downward as required, then securely tighten the pinch screw (K).

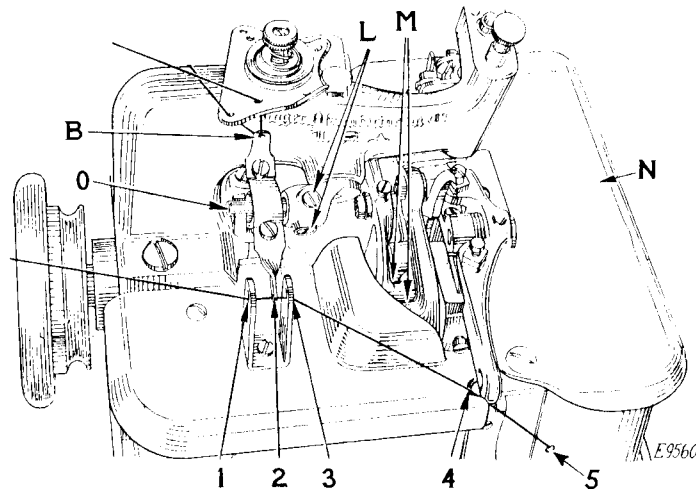

Fig. 43
ADJUSTMENTS

To Change the Stroke of the Needle Bar

A variation in the amount of needle bar stroke can be obtained by adjusting the ball stud (O, Fig. 43). To lengthen the stroke, loosen the two set screws (L, Fig. 43) in the needle bar crank and move the ball stud inwardly or toward the crank. To shorten the stroke of the needle bar, move the ball stud outwardly or away from the crank, then securely tighten the set screws (L).

To Set the Left Hand Looper

Turn the balance wheel over from you until the needle bar is in its lowest position. At this position, the looper point should be about $\frac{1}{32}$ inch to the left of the needle. Now turn the balance wheel until the needle bar has risen $\frac{3}{32}$ inch from its lowest position and the point of the looper should be at the centre of the needle.

The left hand looper should be set in the looper carrier by means of the screw (A, Fig. 45), so that the point of the looper on its loop taking stroke passes as close as possible to the needle without striking it. The point of the right hand looper or spreader should pass at the recess back of the left hand looper eye as close as possible without touching it.

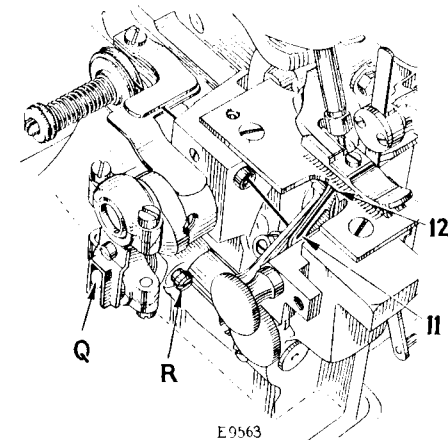

Fig. 44
ADJUSTMENTS

A variation in the amount of the looper motion can be obtained by adjusting the ball stud (Q, Fig. 44). To increase this motion, loosen the set screw (R, Fig. 44) in the looper lever and move the ball stud (Q) inwardly or toward the looper lever. To decrease the motion, move the ball stud outwardly or away from the looper lever. After the desired motion has been obtained, securely tighten the set screw.

To Adjust the Trimmer

The lower knife (B, Fig. 45) should always be fastened in position when removing or replacing the upper knife. The lower knife is adjustable to the right or left and its position governs the position of the upper one, also the width of bight on the goods.

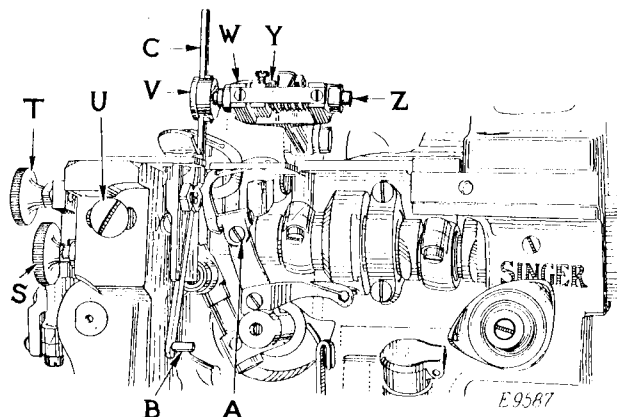

FIG. 45
ADJUSTMENTS

To remove the lower knife (B, Fig. 45), loosen the thumb screw (T, Fig. 45) and draw the knife out downwardly.

To replace the lower knife, have the presser foot and feed down, press the upper knife holder (V, Fig. 45) toward the balance wheel, and push the lower knife upwardly so as to touch the presser foot without lifting it, then tighten the thumb screw (T, Fig. 45).

To adjust the trimmer sidewise, loosen the thumb screw (E, Fig. 42) and move the extension bracket (D, Fig. 42) to the right or away from the upper knife; loosen the screw (U, Fig. 45) and turn the thumb screw (S, Fig. 45) inwardly or outwardly until the trimmer is in the desired position, then securely tighten the screw (U, Fig. 45). Move the extension bracket (D, Fig. 42) back toward the upper knife, leaving just enough clearance between the upper knife and the bracket so as to allow free movement of the upper knife, then tighten the thumb screw (E, Fig. 42).

To remove the upper knife (C, Fig. 45), loosen the screw (Z, Fig. 45) at the end of the knife holder, press the knife holder (V, Fig. 45) toward the balance wheel and remove the knife.

When replacing the upper knife, have the knife holder in its lowest position and pressed toward the balance wheel, insert the knife and set it so that its cutting edge is just below the cutting edge of the lower knife, then tighten the clamping screw (Z, Fig. 45).

To Change the Width of Bight

The positions of the trimmer and chaining-off finger determine the width of bight on the goods.

For a wider bight, move the trimmer and the chaining-off finger on the presser foot to the right. For a narrower bight, move the trimmer and chaining-off finger to the left.

If the desired effect cannot be obtained by these adjustments, it will be necessary to change the size of the chaining-off finger on the presser foot.

To Adjust the Upper Knife Tension

The knives must always have spring contact with each other; the amount of pressure can be obtained by adjusting the knife holder guide.

When the knives are in contact, the space between the guide (Y, Fig. 45) and the knife lever (W, Fig. 45) should be about $\frac{1}{32}$ inch.

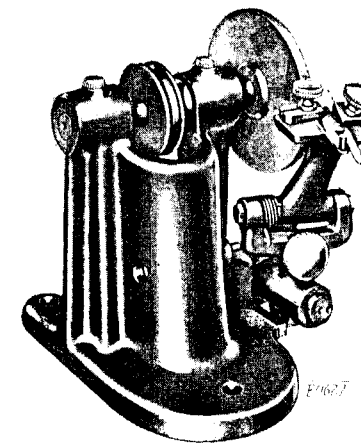

FIG. 46
KNIFE GRINDER 41335

To Sharpen the Knives

Knife Grinder 41335, here illustrated, is recommended for sharpening Movable Knives 42033, 42111 and 42213, also Stationary Knife 42046.

Knife Grinder 41819 is recommended for sharpening Movable Knife 42305, also Stationary Knife 42309.

The use of these grinders ensures the correct angle and shape of the cutting edge of the knives.

To Set the Feed Dogs on Machines 81-50 and 81-56

The front feed dog should be set so that when it is raised to its highest point by the feed lifting eccentric, the full depth of the teeth will project above the throat plate.

When very elastic materials are to be sewn, the back feed dog should remain in its raised position only long enough to permit the work to come out flat.

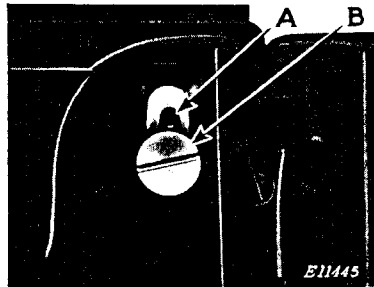

FIG. 47

To Adjust the Gathering Feed on Machine 81-53

The amount of movement of the rear feed dog is determined by the position of the slide block which is held in place by the thumb screw (B, Fig. 47) at the back of the machine. Moving the thumb screw downward in the slot increases the gathering motion, and moving it upward decreases this motion.

If insufficient gathering effect is obtained with the thumb screw (B) at the lower end of the slot, the range of adjustment may be increased by removing the thumb screw and inserting it in the upper hole (A, Fig. 47) in the slide block.

When the desired gathering effect is obtained the thumb screw should be tightened.

Genuine Singer Needles should be used
in Singer Machines.
These Needles and their Containers
are marked with the
Company's Trade Mark "SIMANCO." 1

Needles in Containers marked
"For Singer Machines"
are not Singer made needles. 2