

# **SINGER**

**81-60,65,70,72,73,75,76,77,78**

# USE SINGER\* OILS and LUBRICANTS

*They insure freedom from lubricating trouble and give longer life to sewing equipment*

*The following are the correct lubricants for this machine:*

**TYPE B** — MANUFACTURING MACHINE OIL, HEAVY GRADE

*When an oil is desired which will produce a minimum of stain on fabrics, even after a long period of storage, use:*

**TYPE D** — MANUFACTURING MACHINE OIL, HEAVY GRADE

## OTHER SINGER LUBRICANTS

**TYPE E** — THREAD LUBRICANT

For lubricating the needle thread of sewing machines for stitching fabrics or leather where a thread lubricant is required.

**TYPE F** — MOTOR OIL

For oil lubricated motors and plain bearings in power tables and transmitters.

NOTE: All of the above oils are available in 1 quart, 1 gallon and 5 gallon cans.

**GEAR LUBRICANT**

This specially prepared grease is recommended for gear lubrication on manufacturing sewing machines.

**BALL BEARING LUBRICANT**

This pure grease is specially designed for the lubrication of ball bearings and ball thrust bearings of motors and electric transmitters, ball bearing hangers of power tables, etc. Furnished in 1 lb. and 4 lb. tins.

18986

TO ALL WHOM IT MAY CONCERN:

The improper placing or renewal of the Trade Mark "SINGER" or any other of the Trade Marks of The Singer Manufacturing Company (all of which are duly Registered Trade Marks) on any machine that has been repaired, rebuilt, reconditioned, or altered in any way whatsoever outside a SINGER factory or an authorized SINGER agency is forbidden.

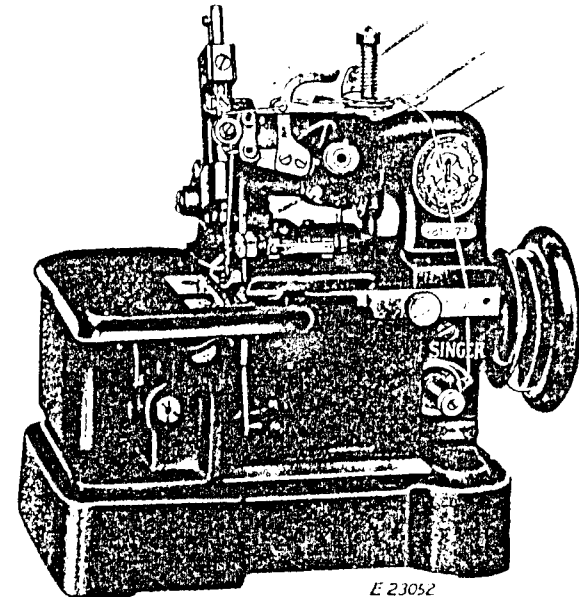

E 23052

## INSTRUCTIONS FOR ASSEMBLING AND ADJUSTING MECHANISM AND REPLACING LUBRICATING WICKS OF SINGER\* HIGH SPEED MACHINES 81-60, 81-65, 81-70, 81-72, 81-73, 81-75, 81-76, 81-77 and 81-78

### Note

When inferior oil is used or when the oil is dirty, absorption of the oil by the wicks may be retarded and the consequent lack of supply of oil for the lubrication of the bearings will cause serious trouble.

Use "TYPE B" or "TYPE D" OIL, sold by Singer Sewing Machine Company. For description of these oils, see inside front cover of this book.

NOTE: Before using new wicks, saturate them with oil.

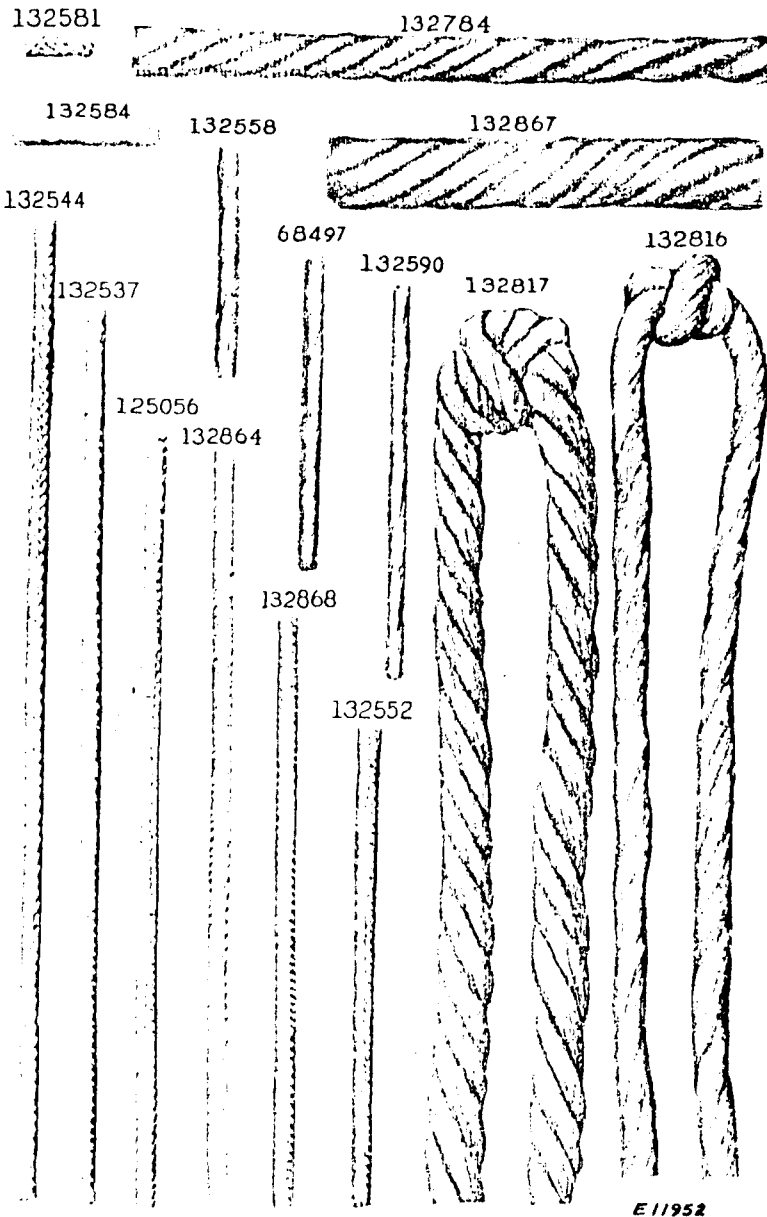

Fig. 2  
Wicks Used In Machines  
(Illustrations Actual Size)

Charts Showing Distribution of Oil

Primary wicks solid black; secondary wicks, sectional black lines; channels or ducts, two black lines.

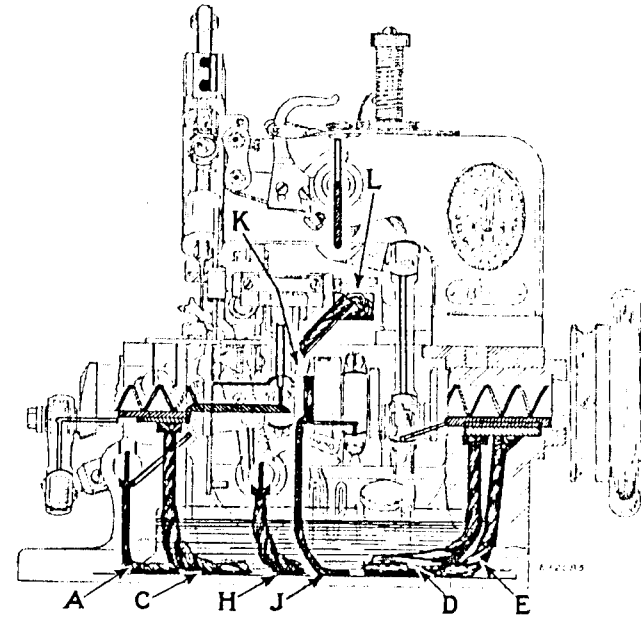

Fig. 3  
Sectional View of Front of Machine

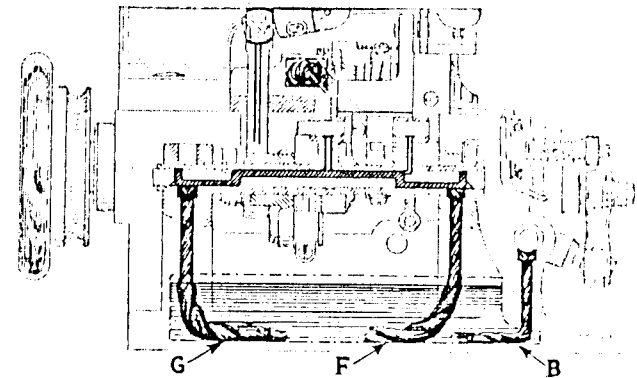

Fig. 4  
Sectional View of Rear of Machine

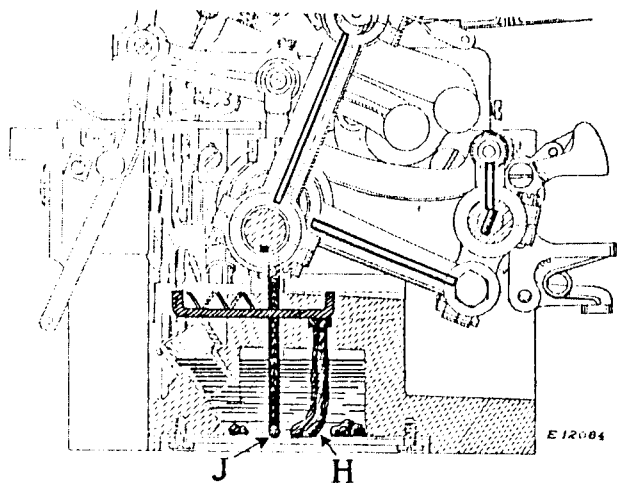

Fig. 5  
Sectional View of Right End of Machine

#### Primary Wicks

One end of each of the nine primary wicks (A,B,C,D,E,F,G,H and J, Figs. 3,4,5 and 6) lies on the bottom of the oil reservoir in the base of the machine and the other end of each of these wicks extends up through the casting. The upper end of each, except J, is formed into a knot which is anchored in a countersunk hole to hold the wick in position. The upper end of wick J is secured in the feed eccentric lubricator shown at K, Fig. 3 and A, Fig. 27.

Each primary wick takes the oil from the reservoir up to the secondary wicks. Wick J receives an additional supply of oil from the top reservoir (L, Fig. 3).

#### Removal of Bottom Cover of Machine

Before removing the bottom cover from the machine, drain the oil through the oil tube in the base of the machine, then tilt the machine back and loosen the screws which hold the bottom cover in position. This will allow the remainder of the oil in the reservoir to drain off.

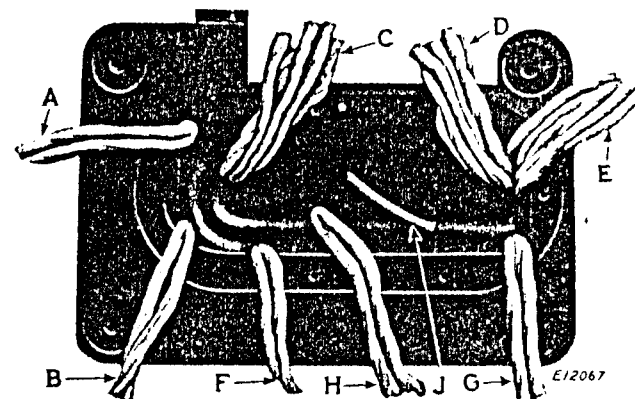

Fig. 6

Underside of Machine After Removal of Bottom Cover Showing Primary Wicks in Position

#### Primary Replacement Wicks

- Wick A, 132816, leads to right hand looper and spreader lever hinge pin (front of machine).
- Wick B, 132816, leads to right hand looper and spreader lever hinge pin (rear of machine).
- Wick C, 132817, leads to frame rotary shaft bushing (left).
- Wick D, 132817, leads to frame rotary shaft flanged bushing (right).
- Wick E, 132817, leads to frame rotary shaft flanged bushing (right).
- Wick F, 132816, leads to feed rock shaft hinge pin (left).
- Wick G, 132816, leads to feed rock shaft hinge pin (right).
- Wick H, 132816, leads to left hand looper lever hinge stud.
- Wick J, 132537, leads to feed eccentric lubricator.

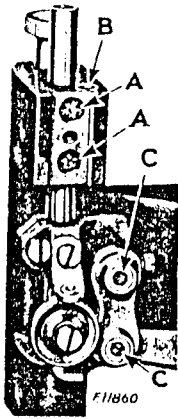

Fig. 7  
Lubrication of Needle Bar Bushing and Links

The needle bar in its bushing is lubricated by two oil wicks (AA) (132581), a channel connecting the two and, for these, oil is applied by hand through the oil hole (B) at the top of the arm.

The two wicks (CC) (132584) oiled by hand, supply oil for the needle bar connecting link hinge pins.

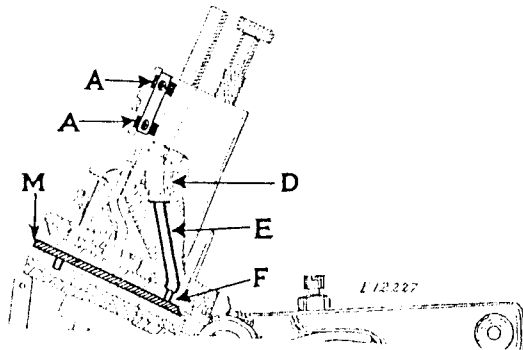

Fig. 8  
Lubrication of Needle Bar Crank

Oil applied by hand to the oil cup (D) travels through the channel (E) to the bushing (F). A hole in the bushing conducts the oil to the wick (M) (132590) which lubricates the needle bar crank pin.

### To Disassemble the Machine

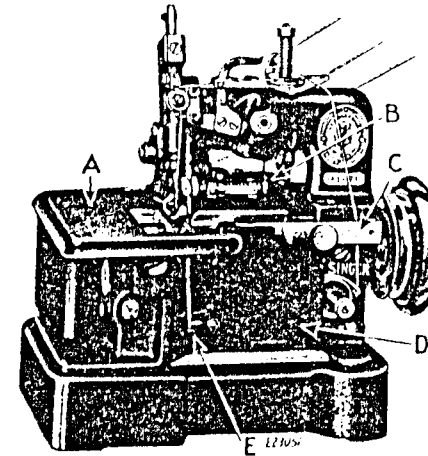

Fig. 9

Remove needle, presser foot, throat plate, feed dog, upper knife, cloth plate (A), frame top cover (B), frame top cover extension (C), hinged frame cover (D), frame side cover (E) and chip guard (F).

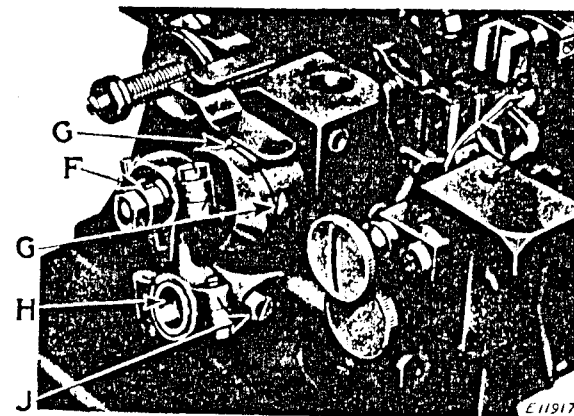

Fig. 10. Disassembly

Remove right and left loopers, tension complete and thread nippers. Remove frame rotary shaft crank (F) complete with ball stud (H) after loosening the two screws (GG) and the screw (J).

Remove the upper connecting rod cap (A) and the lower connecting rod cap (B). After the removal of the connecting rod and its

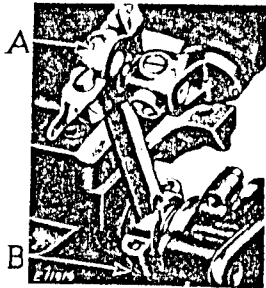

Fig. 11  
Removal of Needle  
Bar Connecting Rod

two caps, temporarily assemble them to ensure correct assembly later. Note the slight groove at one side of each cap and connecting rod for matching.

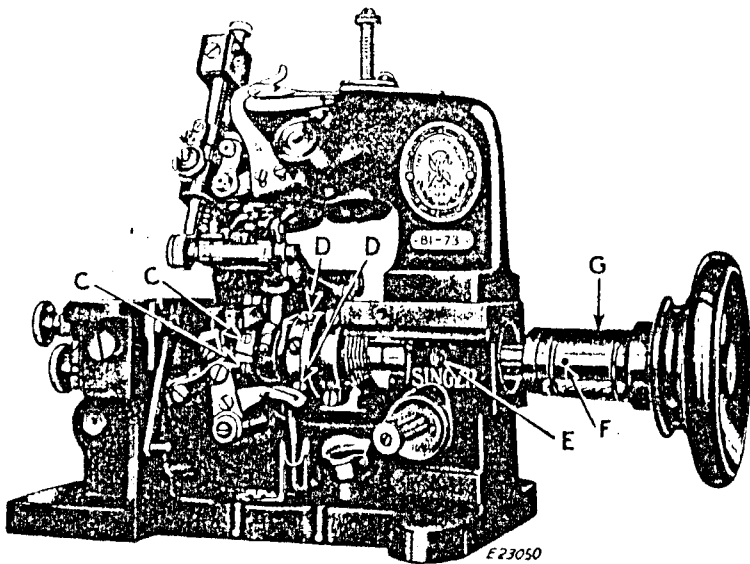

Fig. 12. Removal of Frame Rotary Shaft

Loosen the two set screws (CC) in feed lifting eccentric, loosen the two small set screws (DD) in feed eccentric (the two larger screws are used for regulating the length of feed). Take out the set screw indicated at E. Turn the shaft so that the crank will pass through the clearance in the casting (A, Fig. 30). Tap gently with a mallet at the left end of the shaft and withdraw the shaft with machine pulley and bushing (G) as shown above.

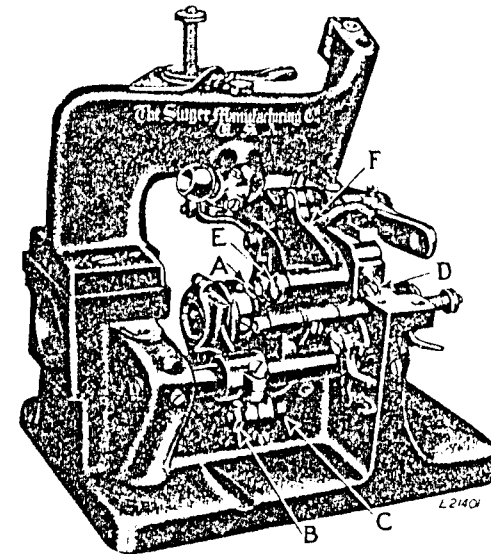

Fig. 13  
Removal of Feed Eccentric

Take off nut (B) and remove screw (C). Remove connecting rod and feed eccentric in one unit, then remove the feed eccentric lubricator (A).

Loosen set screw (D) and after taking out hinge pin (E), remove the presser lever (F).

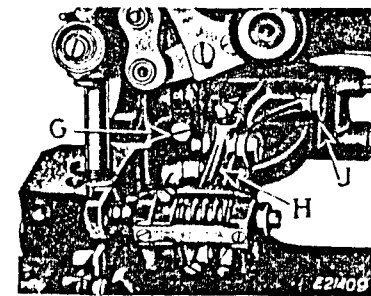

Fig. 14  
Removal of Knife Lever

Loosen set screw (G) and after taking out hinge pin (J), remove the knife lever (H) and eccentric in one unit.

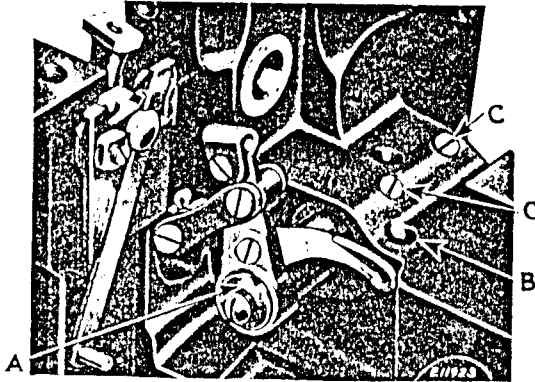

Fig. 15  
Removal of Right and Left Looper Levers

Loosen set screws (CC) and withdraw left hand looper lever hinge stud (A). Loosen set screws (A and E, Fig. 32) and remove hinge pin (H, Fig. 32). Take out both the right and left hand loopers in one unit.

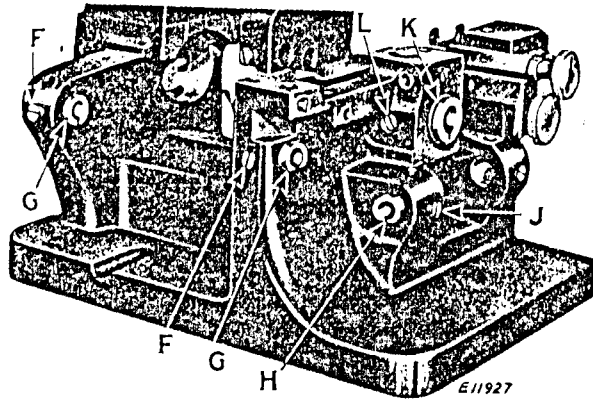

Fig. 16  
Removal of Bushings

Loosen set screws (FF) and remove the split bushings (GG) for feed rock shaft hinge pin. Also loosen set screw (J) and remove the split bushing (H) for right hand looper and spreader lever hinge pin. Remove frame rotary shaft bushing (K) after taking out set screw (L).

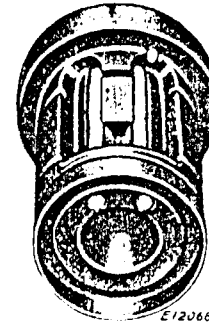

Fig. 17

Replacing the Wicks for Frame Rotary Shaft Flanged Bushing 132866

Push the two ends of the small wick 132868 through the holes at the flanged end of the bushing and secure them in the front holes as shown in Fig. 17. Be sure to press the wick down into the recess of the bushing.

Pack the heavier wick 132867 over the smaller wick as shown in Fig. 18, and snap the two wick retainer springs 132603, shown at A, Fig. 18, into place.

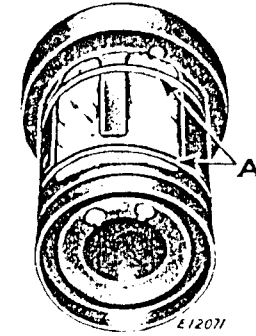

Fig. 18

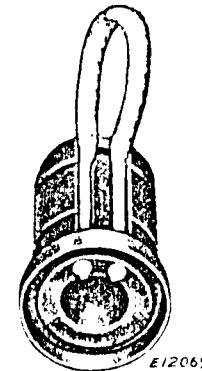

Fig. 19

Replacing the Wick for Frame Rotary shaft Bushing 132930

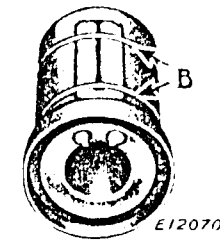

Fig. 20

After securing both ends of wick 132864 in the holes at the flanged end of the bushing, push the wick down into the recess of the bushing as shown in Fig. 19, fold back the remainder of the wick (Fig. 20) and snap the two retainer springs 132715, shown at B, Fig. 20, into place.

12

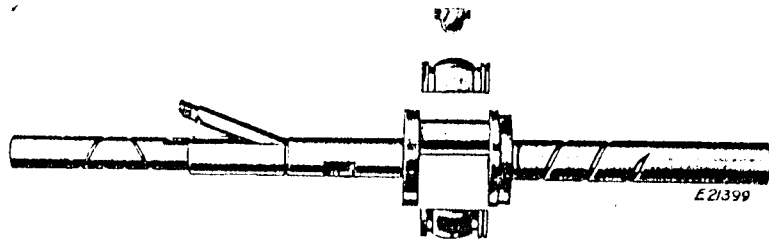

Fig. 21  
Frame Rotary Shaft Showing  
Ball Sleeve Replacement 132790

Fit wick 132558 into its retainer 132559 (Fig. 21) and put both into position in the groove in the shaft and press the retainer down firmly.

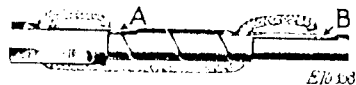

Fig. 22  
Right Hand Looper And  
Spreader Lever Hinge Pin 132899

Wick 125056 is threaded in hinge pin 132899, as shown in Fig. 22, one end being positioned in the hole (A) at the left and the other in the hole (B) at the right.

Wick 132537 is threaded in feed eccentric lubricator, as shown in Fig. 23, the upper end of the wick being positioned in the hole in the groove at the right.



Fig. 23  
Feed Eccentric Lubricator  
132785

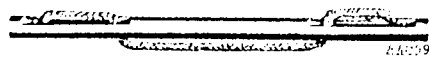

Fig. 24  
Feed Rock Shaft  
Hinge Pin 132542

Wick 132544 is threaded in hinge pin 132542, as shown in Fig. 24.

Wick 132552 is threaded in hinge stud 132798, as shown in Fig. 25.

NOTE: Be sure that the wicks are pressed into the recesses of the pins and bushings so that they cause no obstruction when the pins and bushings are being placed in the machine.

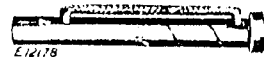

Fig. 25  
Left Hand Looper  
Lever Hinge Stud 132798

13

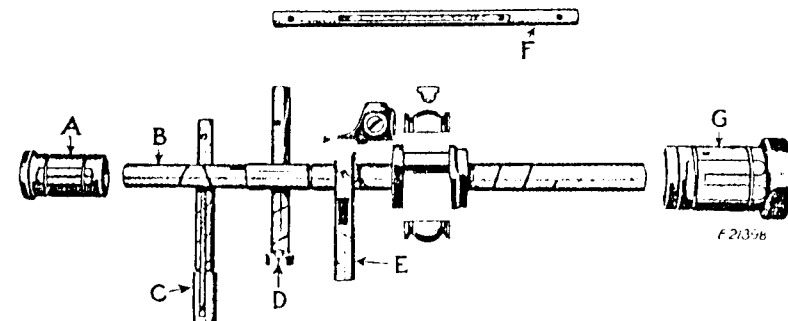

Fig. 26  
Pins and Bushings Threaded with Wicks

- A. 132930, frame rotary shaft bushing (front) with wick 132864.
- B. 132819, frame rotary shaft with wick 132558 and retainer 132559.
- C. 132699, right hand looper and spreader lever hinge pin with wick 125056.
- D. 132798, left hand looper lever hinge stud with wick 132552.
- E. 132879, needle bar crank (back) with wick 132590.
- F. 132542, feed (front) rock shaft hinge pin with wick 132544.
- G. 132866, frame rotary shaft flanged bushing with wicks 132867 and 132868, retainer spring 132603 and oil sling cover 132892.

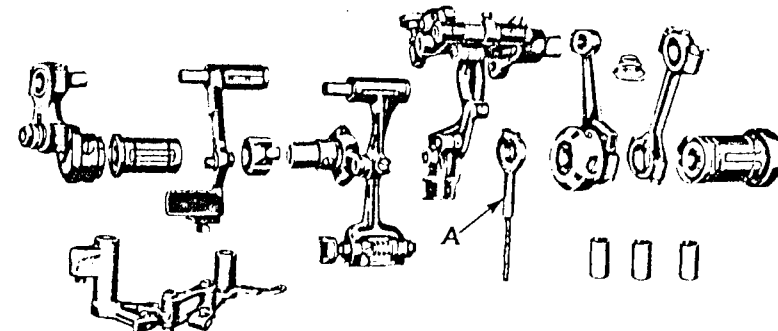

Fig. 27  
Some of the Units Ready for Assembly





E12375

Fig. 28

Primary Wick 132817. Used for Bushings  
at Each End of Frame Rotary Shaft

An overhand knot as shown (Fig. 28), holds this primary wick in place. The knot in the primary wicks must not be made too tight. It should just fill the countersunk space made for it in the bed casting and must make contact with the secondary wicks to assure the lubrication of the bearings.

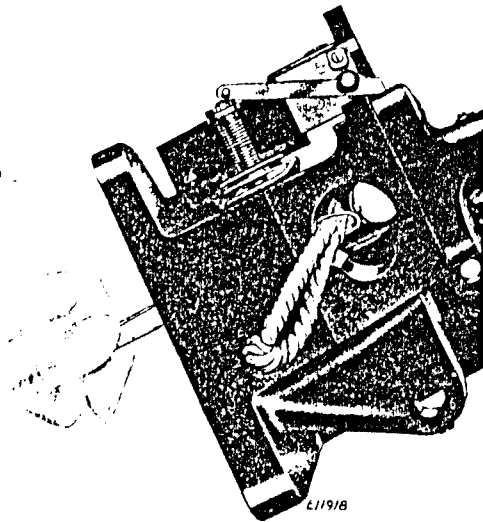

E11918

Fig. 29.

Method of Inserting Wicks

After forming a loop with a thin piece of wire or an ordinary piece of twine, the wick is drawn down into place in the hole in the casting as shown (Fig. 29).

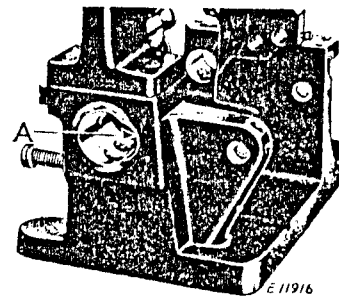

E11916

Fig. 30  
Five of the Primary Wicks  
Drawn into Place

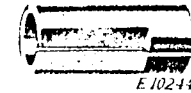

E10244

Fig. 31  
Bushing for Looper Lever  
Hinge Pin (one) and for Feed  
Rock Shaft Hinge Pin (two)

### Assembly

Having installed the primary wicks and put the secondary wicks into their respective hinge pins, etc., the parts of the machine are now ready for assembly.

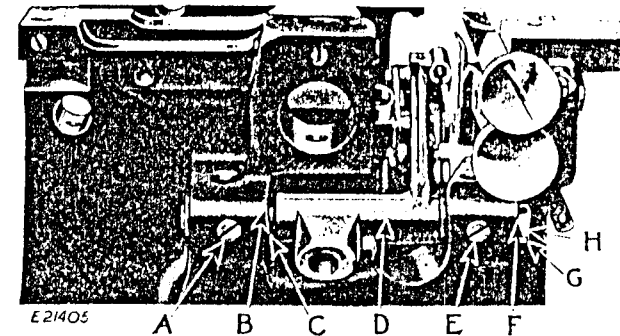

E21405

A B C D E F

H  
G

Fig. 32

Installing of Looper Levers

Insert the split bushing (Fig. 31) in the hole indicated at (B, Fig. 32) putting the flattened end in first from the front of the machine so that the looper lever (D) will bear against the completely rounded end of the bushing. The slot in the bushing must be exactly in the center at the bottom, so that contact of the wick at the end of the hinge pin (H) will be made, through the slot in the bushing, with the primary wick (B, Fig. 6). Then

slightly tighten set screw (A, Fig. 32). Insert hinge pin (H, Fig. 32) into the hole of the casting indicated at (F) and into the sleeve of the looper lever, then enter the end of the hinge pin into the bushing (C), having the wick in the pin at the bottom of the split bushing. The flat of the hinge pin shown at (G) will then be in position to receive the set screw (E) and the wick in the shoulder of the hinge pin will be in contact with the primary wick (A, Fig. 6). Then insert the left hand lever hinge stud (Fig. 25) through the hollow of looper lever (B, Fig. 33) and into the hole (C) of the casting, being careful to see that the oil wick in the hinge stud is central at the bottom to make contact with the primary wick (H, Fig. 6). Push the stud (Fig. 25) in as far as possible without binding, then securely tighten set screws (D, Fig. 33). Move the looper lever (D, Fig. 32) to the right or left, as required, so that there is a little sidewise play in the connecting links (A, Fig. 33) of the right and left hand loopers. Then move the split bushing (C, Fig. 32) over to the looper lever (D, Fig. 32) leaving it free so as not to bind. Firmly tighten the set screws (A and E, Fig. 32).

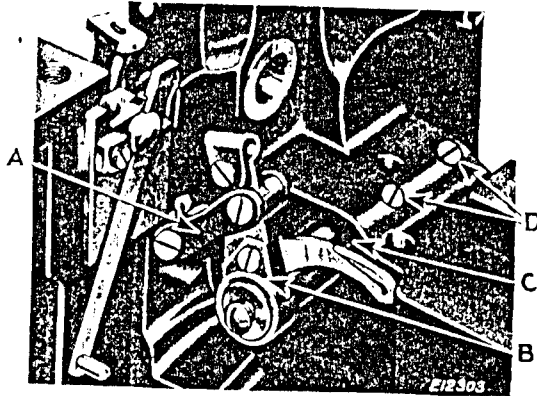

Fig. 33  
Installing and Adjusting Looper Levers

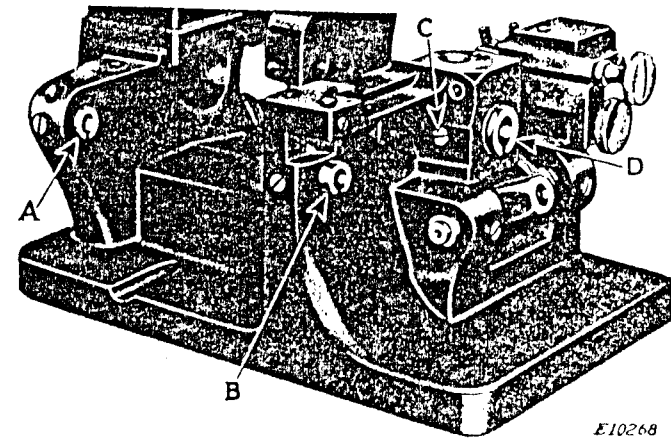

Fig. 34  
Replacing of Bushings

To replace the two split bushings (A and B) for the feed rock shaft hinge pin: Into the hole at the left, enter the flattened end of the bushing (Fig. 31) in an outward direction (toward the left). Into the hole at the right insert the flattened end of the bushing and push the bushing outwardly (toward the right).

When the feed rock shaft is installed, each of its two bearing ends will bear against the completely rounded ends of each bushing. The slot in each bushing must be exactly in the center at the bottom so that contact of the wick in the hinge pin of the feed rock shaft will be made through the slot of each bushing with the primary wicks (F and G, Fig. 6).

Replace the front rotary shaft bushing (D), having the wick exactly in the center at the bottom to make contact with the primary wick (C, Fig. 6). Then locate the hole in the bushing through the tapped hole shown at (C, Fig. 34) so that it will receive the end of the set screw. Insert the screw and firmly tighten it.

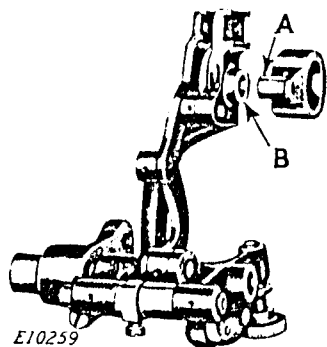

Fig. 35  
Installing Feed Rock Shaft

Before installing the feed rock shaft which is assembled with other feed parts, as shown in Fig. 35, place the spur (A) of the feed lifting eccentric into the hole of the feed bar at (B).

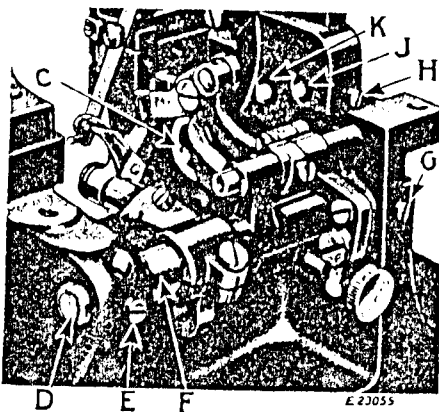

Fig. 36  
Installing the Feeding Mechanism

When inserting the hinge pin (D, Fig. 36) of the feed rock shaft make sure that the wick at each end of the pin is directly over the slots in the bushings. Then slightly tighten the set screws (E and G).

Insert the feed lifting eccentric (L, Fig. 37) into the hole (C, Fig. 36) of the feed lifting eccentric connection and insert the end of the knife lever hinge stud (M, Fig. 37) into the hole (K, Fig. 36) of the casting, having the flat in the hinge stud in position to receive the set screw (G, Fig. 14). Then securely tighten the set screw.

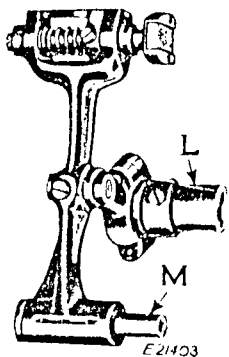

Fig. 37  
Installing Knife Lever

### Installing Frame Rotary Shaft

Place the circular ridge of the feed eccentric lubricator in the hollow of the feed eccentric, then insert the end of the lubricator into the hole

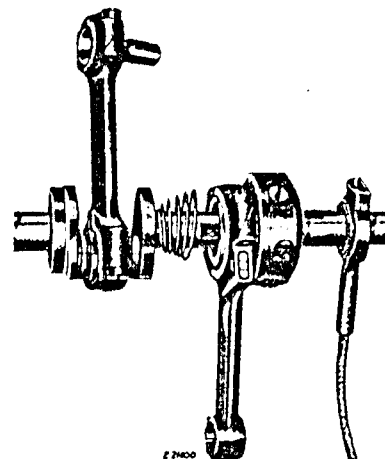

Fig. 38 Parts Correctly Assembled  
on Frame Rotary Shaft  
(View from Rear of Machine)

(B, Fig. 15). Now, having the flanged bushing and machine pulley on the frame rotary shaft, insert the end of the shaft in the hole at the end of the casting, being careful to see that the hole for the end of the set screw in the flanged bushing is in the position shown at F, Fig. 12. Turn the shaft so that the crank will pass through the clearance in the casting (A, Fig. 30), then carefully tap the hub of the machine pulley so that the flanged bushing moves into the

casting and the rotary shaft enters, in the following order, the feed eccentric lint cover (spring), feed eccentric, feed eccentric lubricator, (see Fig. 38 for their proper positions on the rotary shaft), feed lifting eccentric and rotary shaft front bushing. The hole in the flanged bushing for the set screw can be seen through the tapped hole (E, Fig. 12) in the casting. Insert the set screw, making certain that the end of the screw enters the hole in the bushing, and firmly tighten it.

Turn the machine pulley over from you as in regular operation and remove the first screw (1, Fig. 39) in the feed lifting eccentric. Turn the shaft until the flat on the shaft can be seen through the set screw hole, replace and firmly tighten the set screw on the flat. Then firmly tighten the other set screw (2).

Having the two set screws (one of which is designated by B, Fig. 39) loose in the feed eccentric, push the feed eccentric lubricator (A) and feed eccentric snugly up against the feed lifting eccentric, making sure that the tube of the feed eccentric lubricator is exactly upright.

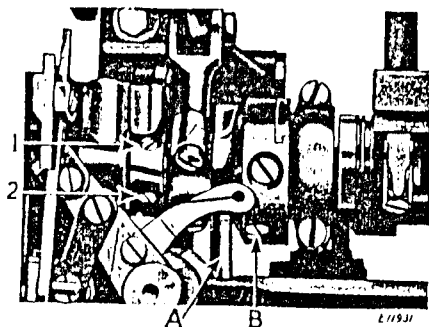

Fig. 39  
Installing Frame Rotary Shaft

Remove the first screw (B, Fig. 39) in the feed eccentric and after locating its flat on the shaft, replace this set screw and firmly tighten it. Then tighten the second set screw.

Secure the lower end of the connecting rod of the feed eccentric to the crank of the feed rock shaft with the screw and nut (B and C, Fig. 13). Be sure that these two parts are in proper alignment.

### Installing the Needle Bar Connecting Rod

The small (upper) end of the connecting rod has its bearing on the ball stud of the needle bar crank and should be assembled with the grooves on the side of the connecting rod toward the rear of the machine and matched with the groove on the cap. The right hand looper thread pull-off and the left hand looper thread pull-off are inserted under the heads of the screws and the screws securely tightened, as shown in Fig. 11.

To assemble the lower end of the connecting rod to the rotary shaft, turn the machine so that you are working from its front, insert the guide (A, Fig. 21), into the recess in the top of the replacement bushing, place the bushing on the rotary shaft with the GROOVED END OF THE BUSHING TOWARD THE MACHINE PULLEY, move the connecting rod down and over the bushing so that the guide in the recess of the bushing also fits into the slot cut out for it in the connecting rod bearing, place the other half of the bushing in the cap, with the grooved end of the bushing toward the machine pulley and the groove on the cap match with the groove on the connecting rod, place these parts in position on the shaft, insert the screws and tighten them securely after placing the right hand looper thread controller under the head of the nearest screw, as shown at (E, Fig. 46).

### To Assemble the Rotary Shaft Crank

Insert the threaded end (L) of the crank through replacement bushing (K), making certain that position pin (O) enters the recess made for it at the end of replacement bushing (K). Then insert the replacement bushing through ball sleeve (G) and place washer (F) and nut (E) on the threaded end of the crank and securely tighten nut (E). Insert guide (M) into the slot at the bottom of bearing (D), then place the ball sleeve in bearing (D). Be sure that the groove on the side of the connection is facing you.

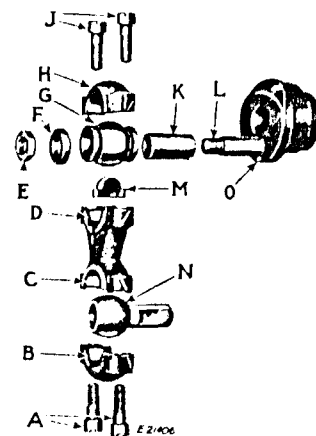

Fig. 40. Rotary Shaft  
Crank Disassembled

Now place top cap (H) down and over ball sleeve (G), with the groove in the cap facing you, and tighten it securely with screws (J). Place ball stud (N), with the stud extending to the right, between bottom cap (B) and bearing (C), the groove in the cap and connection facing you, then insert screws (A) and tighten them.

### Installing the Rotary Shaft Crank

While placing the rotary shaft crank on the end of the shaft, enter the end of ball stud (A) into the hole in the right hand looper lever. Then tighten screw (B). The extent of the insertion of the stud into the hole controls the stroke of the loopers, as explained on page 25, Fig. 45. The rotary shaft crank (C) should be located tightly up against the rotary shaft bushing, but not so tight as to bind. Turn the shaft until the slot in the end of the shaft is in line with the second screw hole (2) in the rotary shaft crank, then insert the pointed timing screw and firmly tighten it in the slot of the shaft and tighten set screw (1).

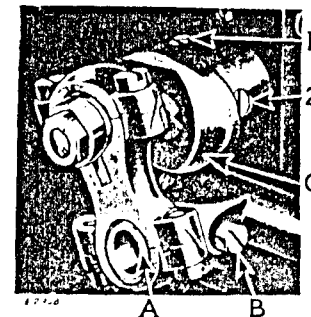

Fig. 41  
Installing Rotary Shaft Crank

### Installing of Feed Dog and Throat Plate

(See Fig. 36)

After the feed dog is installed, place the throat plate in position. The correct position of the feed dog between the bars of the throat plate is obtained by moving the feed rock shaft (F, Fig. 36) to the right or left as desired. Then bring the bushings on each side close up to the ends of the feed rock shaft bearings and firmly tighten the set screws (E and G, Fig. 36).

### Installing of Loopers, Etc.

(See Fig. 10)

Replace the tension complete, thread nippers and right and left hand loopers.

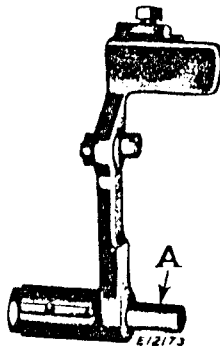

Fig. 42  
Installing Presser Lever

### Installing Presser Lever

Insert the presser lever hinge stud (A) into the hole (J, Fig. 36) in the casting, having the flat in position to receive the set screw (H, Fig. 36), then firmly tighten the set screw.

### To Complete the Assembly

(See Fig. 9)

Replace frame side cover, hinged frame side cover, chip cover, frame top cover extension, frame top cover, cloth plate, upper knife, presser foot and needle.

### Oiling

Use "TYPE B" or "TYPE D" OIL, sold by Singer Sewing Machine Company.

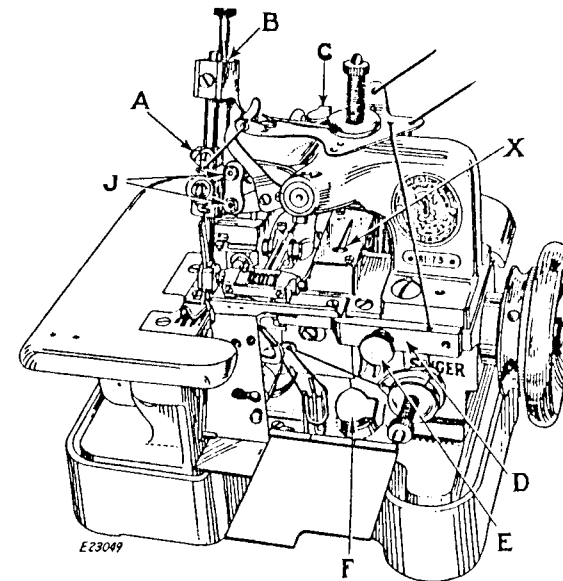

Fig. 43  
Front View, Showing Oiling Points and Adjustments

Apply oil to oil hole (X) and oil cup (F) until the reservoirs are full. Fill the oil cup (C) at the top of the machine and thoroughly saturate the wick through the hole (B) in the casting near the top of the needle bar. Then oil the needle bar link connection (J) at the front of the machine. Also, apply oil to the knife lever and presser lever bearings (M, Fig. 44) at the back of the machine.

THEREAFTER, replenish the oil supply in the reservoirs about once each day, or often enough to keep them filled. Twice a day apply oil to the remainder of the oiling points.

The surplus oil drips into the cast iron base and thence into the glass drain jar which is provided in the base for this purpose. Oil should not be used over again.

CAUTION. A machine new from the factory, or one that has not been used for some time, should not be operated until about three hours after filling the reservoirs. Failure to heed this caution may result in serious damage to the mechanism of the machine.

### "Running-In"

When the machine has been assembled and thoroughly lubricated, it should be carefully "run in" for about twelve hours, at a speed not exceeding 3000 revolutions per minute, and gradually brought up to the desired speed. The maximum speed is 4500 revolutions per minute for long runs (3500 for Machine 81-60 and 4200 for Machines 81-75 and 81-77).

### Adjustments

#### To Set the Needle Bar at the Correct Height

Remove the throat plate in order to obtain a clear view of the needle and loopers.

Turn the machine pulley over from you until the needle bar has risen  $\frac{3}{32}$  inch from its lowest position. The point of the left hand looper, on its loop taking stroke, should then be at the center of the needle, and the eye of the needle should be about  $\frac{1}{16}$  inch below the looper point. If the needle bar is not at the correct height, loosen the pinch screw (A, Fig. 43) and move the needle bar upward or downward as required, then securely tighten the pinch screw (A).

NOTE. On Machine 81-78 the left hand looper should be adjusted to the left hand needle.

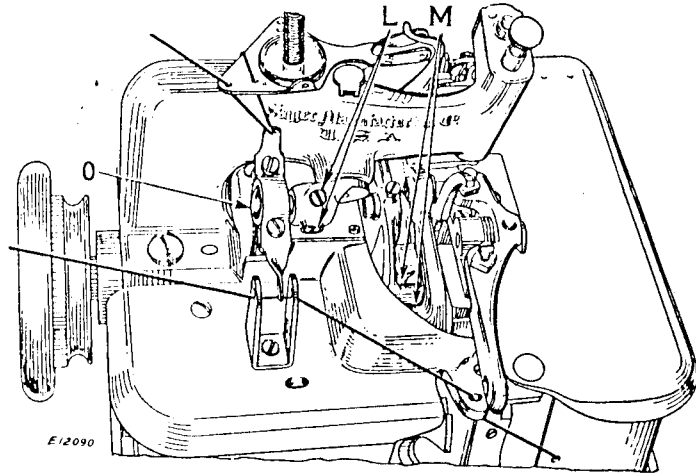

Fig. 44. Adjustments

#### To Change the Stroke of the Needle Bar

A variation in the amount of needle bar stroke can be obtained by adjusting the ball stud (O, Fig. 44). To lengthen the stroke, loosen the two set screws (L, Fig. 44) in the needle bar crank and move the ball stud inwardly or toward the crank. To shorten the stroke of the needle bar, move the ball stud outwardly or away from the crank, then securely tighten the set screws (L).

### To Set the Left Hand Looper

Turn the machine pulley over from you until the needle bar is in its lowest position. At this position, the looper point should be about  $\frac{1}{32}$  inch to the left of the needle. Now turn the machine pulley until the needle bar has risen  $\frac{3}{32}$  inch from its lowest position and the point of the looper should be at the center of the needle. (Some threads and materials require more needle loop, in which case the looper can be set  $\frac{1}{16}$  inch from the needle.)

The left hand looper should be set in the looper carrier by means of the screw (A, Fig. 46), so that the point of the looper on its loop taking stroke passes as close as possible to the needle without striking it. The point of the right hand looper or spreader should pass at the recess back of the left hand looper eye as close as possible without touching it.

NOTE. On Machine 81-78 the left hand looper should be adjusted to the left hand needle.

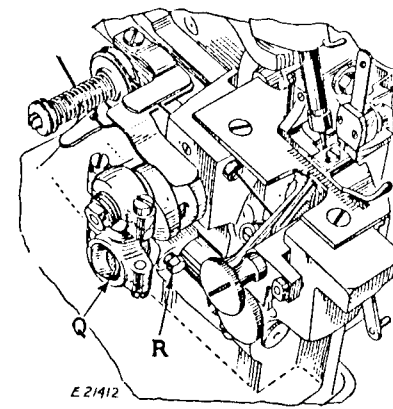

Fig. 45

#### To Regulate the Amount of Looper Motion

A variation in the amount of the looper motion can be obtained by adjusting the ball stud (Q, Fig. 45). To increase this motion, loosen the set screw (R, Fig. 45) in the looper lever and move the ball stud (Q) inwardly or toward the looper lever. To decrease the motion, move the ball stud outwardly or away from the looper lever. After the desired motion has been obtained, securely tighten the set screw.

#### To Adjust the Trimmer

The lower knife (B, Fig. 46) should always be fastened in position when removing or replacing the upper knife. The lower knife is adjustable to the right or left and its position governs the position of the upper one, also the width of bight on the goods.

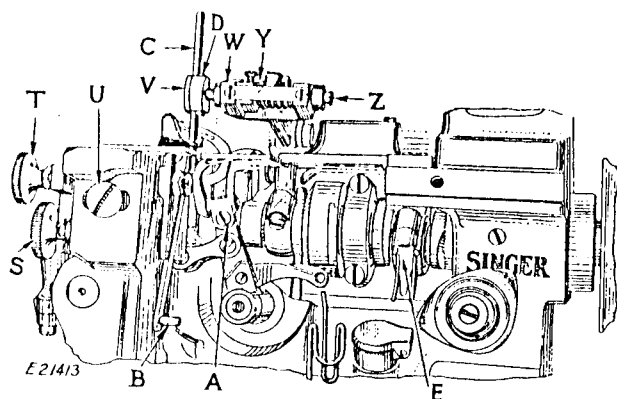

Fig. 46  
Adjustments

To remove the lower knife (B, Fig. 46), loosen the thumb screw (T, Fig. 46) and draw the knife out downwardly.

To replace the lower knife, have the presser foot and feed down, press the upper knife holder (V, Fig. 46) toward the balance wheel, and push the lower knife upwardly so as to touch the presser foot without lifting it, then tighten the thumb screw (T, Fig. 46).

To adjust the trimmer sidewise, loosen the thumb screw (E, Fig. 43) and move the extension bracket (D, Fig. 43) to the right or away from the upper knife; loosen the screw (U, Fig. 46) and turn the thumb screw (S, Fig. 46) inwardly or outwardly until the trimmer is in the desired position, then securely tighten the screw (U, Fig. 46). Move the extension bracket (D, Fig. 43) back toward the upper knife, leaving just enough clearance between the upper knife and the bracket so as to allow free movement of the upper knife, then tighten the thumb screw (E, Fig. 43).

To remove the upper knife (C, Fig. 46), loosen the screw (Z, Fig. 46) at the end of the knife holder, press the knife holder (V, Fig. 46) toward the machine pulley and remove the knife.

When replacing the upper knife, have the knife holder in its lowest position and pressed toward the machine pulley, insert the knife and set it so that its cutting edge is just below the cutting edge of the lower knife, then tighten the clamping screw (Z, Fig. 46).

### To Change the Width of Bight

The positions of the trimmer and chaining-off finger determine the width of bight on the goods.

For a wider bight, move the trimmer and the chaining-off finger on the presser foot to the right. For a narrower bight, move the trimmer and chaining-off finger to the left.

For a wider bight than is possible with the above instructions, remove the gib (D, Fig. 46) and replace it at the left of the upper knife. The lower knife should then be adjusted accordingly.

### To Adjust the Upper Knife Tension

The knives must always have spring contact with each other; the amount of pressure can be obtained by adjusting the knife holder guide.

When the knives are in contact, the space between the guide (Y, Fig. 46) and the knife lever (W, Fig. 46) should be about  $1/32$  inch.

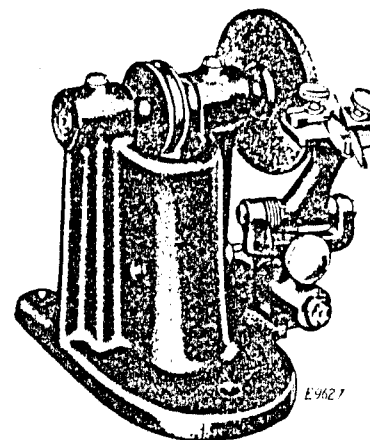

Fig. 47. Knife Grinder 701-5

### To Sharpen the Knives

**SINGER** Knife Grinder 701-5, illustrated, is recommended for sharpening the knives on Machines 81-70, 81-72, 81-73, 81-77 and 81-78. Use Knife Grinder 701-4 for Machines 81-75 and 81-76. The use of these grinders ensures the correct angle and shape of the cutting edge of both knives.

NOTE. Care should be taken when grinding as the knives will not stay sharp if the knife edge has become discolored through improper grinding. Discoloration indicates a loss of temper in the knives.

To Adjust the Gathering Feed  
on Machines 81-73 and 81-77

The amount of movement of the rear feed dog is determined by the position of the lever (A) at the back of the machine.

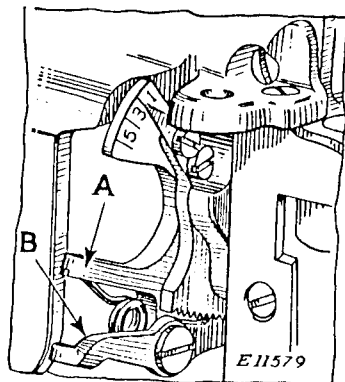

Fig. 48. Adjusting the Gathering Feed

For more gathering motion, press the latch (B) against the lever (A) and move the lever upward. For less gathering motion, move the lever downward.

The markings on the indicator plate aid in duplicating any particular setting.

To Adjust the Gathering Feed  
on Machines 81-70 and 81-76

When very elastic materials are to be sewn, the back feed dog should remain in its raised position only long enough to permit the work to come out flat.

To adjust the gathering feed, loosen the smaller screw (L, Fig. 36) above the regulating thumb screw at the back of the machine and turn the thumb screw outward for more gather and inward for less gather.

SINGER Needles should be used  
in SINGER Machines  
These Needles and their Containers  
are marked with the  
Company's Trade Mark "SIMANCO." 1

Needles in Containers marked  
"FOR SINGER MACHINES"  
are NOT SINGER made needles. 2