

**SINGER**  
99K

EDITORIAL  
COPY

L.P.C.  
8/17/62

*Instructions for Using*

**SINGER**

*Sewing Machines*

*Class 99K*

THE SINGER MANUFACTURING COMPANY



Form K6122  
(762)

*Instructions for using*  
**SINGER**  
SEWING  
MACHINES  
99K\*

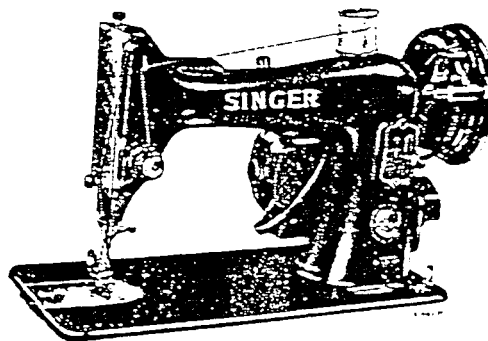

\*A Trade Mark of THE SINGER MANUFACTURING CO.

WHEN YOU OWN A **SINGER** 99K  
MACHINE

you have a smooth running machine which offers you a new world of sewing enjoyment. Exclusive dresses for yourself, clothing for your family, and numerous items for the home—all will be yours at a fraction of their ready-made cost.



TO GET THE MOST ENJOYMENT  
FROM YOUR SINGER

You are entitled to sewing lessons when you become the owner of a new SINGER. A skilled, SINGER-trained teacher personally guides you and assists you in learning the fundamentals of home sewing. Other courses embracing all phases of home sewing are available at low cost.

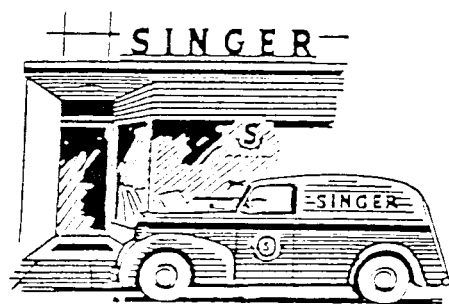

#### EVERYTHING FOR THE WOMAN WHO SEWS

The answer to your sewing needs is at your SINGER SEWING CENTRE. There you will find a wide choice of sewing necessities and notions, sewing instructions and guidance and services for covering buttons, hemstitching, making belts and buckles, to mention a few. Look in your telephone directory under SINGER SEWING MACHINE COMPANY for the SINGER SEWING CENTRE nearest you.

#### SINGER SERVICE

Wherever you go you will find expert, dependable SINGER Service nearby. SINGER is interested in helping you keep your SINGER Sewing Machine in top condition. That is why you should always call your SINGER SEWING CENTRE if your machine ever requires adjustment or repair. When you call your SINGER SEWING CENTRE you can be sure of obtaining the service of a trained SINGER repair man and can be assured of warranted SINGER\* parts when needed! Look for the familiar red "S" Trade Mark on your SINGER SEWING CENTRE and the ever ready SINGER Service Car.

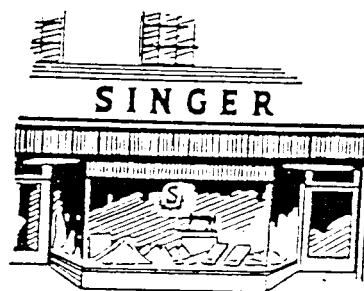

## ELECTRICAL INFORMATION

### The SINGER\* Electric Motor

is located at the back of the machine, and can be supplied for operation on alternating or direct current. Orders must state the catalogue number of the motor, or the voltage, and in the case of alternating current, the number of cycles.

### Before Inserting Electric Plug—

be sure that voltage and number of cycles stamped on motor nameplate are within range marked on electric meter installed by electric power company.

### Electrical Connections for Machine

Push three-pin safety plug into three-pin terminal block at right of machine and connect plug at other end of cord to electric supply point.

### Speed Controller

The speed of machine is regulated by amount of pressure on foot controller or knee controller.

### CAUTION

When you have finished your sewing always disconnect the plug from the electric supply point.

LIGHT

To Turn Light "on" or "off."

To turn on light, reach over machine arm and turn switch V, Fig. 1 to right. To extinguish light turn switch to left.

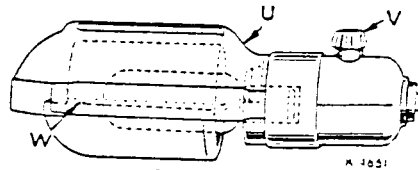

Fig. 1. Light.

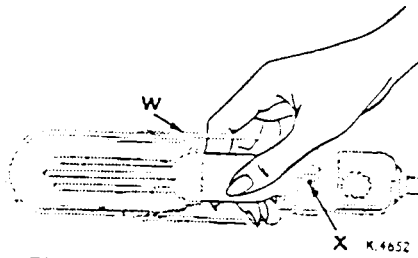

Fig. 2. Removing and replacing bulb.

#### To Remove Bulb

Grasp light socket so that thumb extends over switch V. Press shade with thumb at U to release shade from two catches, and slide it halfway out of shade holder W. Press bulb into socket and at same time turn bulb over from machine as far as it will go to unlock pin X (see Figs. 3 and 4). Withdraw the bulb.

#### To Insert New Bulb

Press bulb into socket and turn it over toward machine until pin X enters notch in socket (see Fig. 3). Return shade to its normal position as shown in Fig. 1.

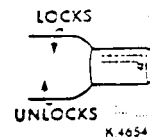

Fig. 3. Locking or unlocking bulb pin.

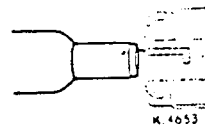

Fig. 4. Inserting bulb in socket.



IF MACHINE IS ELECTRICALLY  
OPERATED

Raise presser foot Q by means of presser bar lifter R to prevent injury to the foot Q and feed T.

Place a piece of material under presser foot and let the foot down upon it. Turn on electric current and, if the combination knee and foot controller is installed as a knee controller, press knee lever to the right. If controller is placed on the floor to be used as a foot controller, press down on pedal of controller. The speed of the machine is controlled entirely by the amount of pressure applied to the controller. Operate machine in this way, without being threaded, until you have become accustomed to guiding the material and operating the controller.

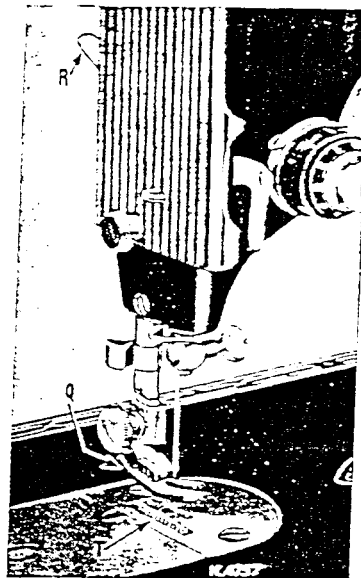

Fig. 5. Front view of machine.

### IF MACHINE IS HAND OPERATED

When the machine is uncovered, the hand attachment will be found to be out of working position as shown in Fig. 6. Pull the small spring stud 2, and turn the handle back until the lever 1, enters the socket 3. Press back the hinged finger 4, Fig. 7 between the spokes of the wheel. The machine is now ready for working, as shown in Fig. 7.

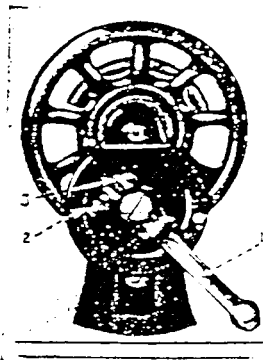

Fig. 6.

NOTE. Before replacing the cover or the machine in its case, the lever should be disengaged and the handle placed in the position shown in Fig. 6.

#### TO OPERATE THE HAND MACHINE

Place a piece of material under the presser foot Q, Fig. 5, and lower the latter by means of the lifter R.

Now turn the handle over from you to work the machine, without being threaded, until you are accustomed to guiding the material with the left hand.

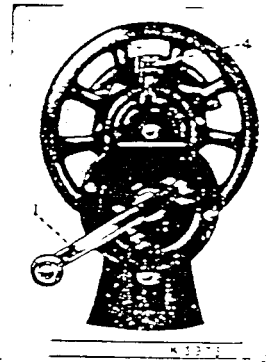

Fig. 7.

#### IF MACHINE IS TREADLE OPERATED

Loosen the hand wheel by turning stop motion screw L, Fig. 16, over toward you, place both feet upon the treadle and turn the hand wheel over toward you, at the same time allowing the feet to move freely and lightly with the motion of the treadle. Continue to do this until a regular and easy movement is acquired and you are able to work the treadle so that you can re-start the machine with the wheel turning toward you.

When familiar with the working movement, tighten the hand wheel by turning the stop motion screw over from you, and place a piece of material under the presser foot Q, Fig. 5. Lower the latter by means of the lifter and again work the machine, without being threaded, until you are accustomed to guiding the material. The belt should be only just tight enough not to slip. If too loose, shorten and rejoin.

#### BELT SHIFTER

This device simplifies throwing off and replacing the belt. To throw off the belt, move the belt shifter to the left (see Fig. 3), working the treadle at the same time. To replace the belt, work the treadle slowly with the hand wheel turning toward you, when a revolution or two of the wheel will bring the belt back into its place.

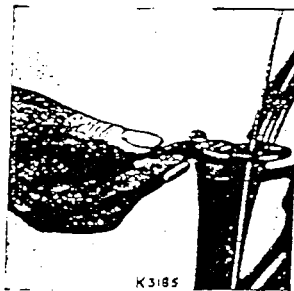
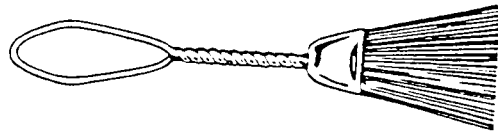

Fig. 3.

### PROTECTION AGAINST RUST DAMAGE

Lint and fluff, if not removed prior to storage will, during humid periods, absorb and hold moisture, and thus accelerate rust damage to highly polished thread handling and other exposed parts. The extent of rust damage would depend upon the length of time the machine remained in idle storage where there is no ventilation. Sudden drops in temperature will cause moisture to form on parts which, if not protected by a film of oil, would rust and damage while in storage.

Proper storage care suggests thorough brush-cleaning to remove all traces of lint and fluff, followed by swabbing of all the exposed parts in Figs. 10 and 11 with a lint-free brush saturated with SINGER Oil.



*SINGER Lint Brush may be purchased at  
your local SINGER SEWING CENTRE.*

TO OIL THE MACHINE and STAND

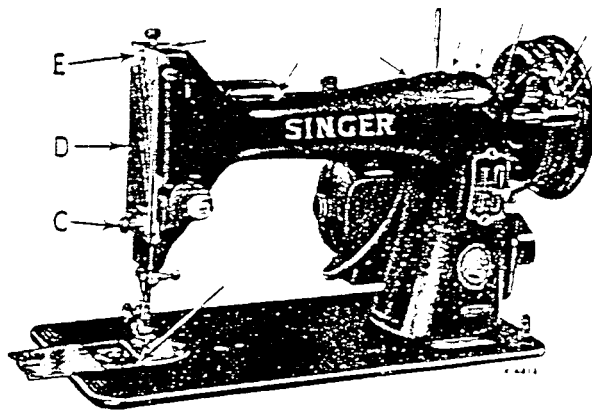

Fig. 9. Front View,  
Showing Oiling Points.

If the machine is used continuously, it should be oiled daily. If moderately used, an occasional oiling is sufficient. Apply one drop of oil at each of the places indicated by the unlettered arrows in Figs. 9, 10 and 12 and carefully clean the machine to insure smooth and satisfactory performance. Oil holes are provided in the

machine for bearings which cannot be directly reached.

Remove face plate D, Fig. 9 by taking out screw C and loosening screw E near the top of the plate. Slip plate over screw E. Oil the points indicated in Fig. 10 and then replace face plate D.

Draw the slide to the left (as shown in Fig. 9) and, after removing the lint and dust which may have accumulated (see instructions on page 35), apply a drop of oil at the place indicated at F, Fig. 11. The slide should then be closed.

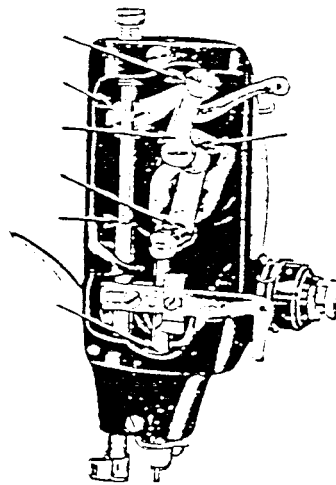

*Fig. 10. Face Plate Removed  
Showing Oiling Points.*



*Fig. 11. Oiling the Sewing Hook.*

To oil the parts underneath the bed of the machine, turn the machine back on its hinges and apply oil to the oil holes and bearings indicated in Fig. 12.

To oil the stand, apply a drop of oil to the centres upon which the band wheel and treadle work, and to both ends of the pitman rod connecting the treadle with the band wheel.

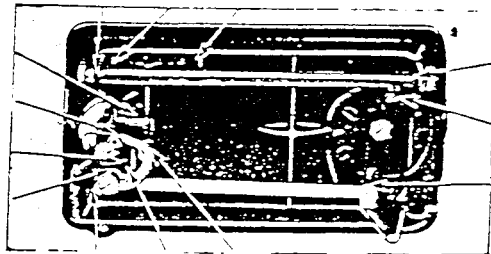

*Fig. 12. Oiling Points on Base of Machine.*

After oiling, run the machine rapidly for a few minutes so that the oil may reach the bearings. Neglect to oil the machine will shorten its life and cause you trouble and annoyance.

Always use SINGER<sup>®</sup> oil. Inferior oil clogs the bearings, prevents efficient working, and causes rapid wear of the mechanism.

CHART SHOWING THE RELATIONSHIP OF TYPES OF FABRICS, THREAD AND NEEDLE SIZES AND MACHINE STITCHES TO THE INCH

TYPES OF FABRIC	THREAD SIZES	NEEDLE SIZES	MACHINE STITCHES PER INCH	
			Inside Seams	Top Stitching
Very thin Silk, Muslin, Cambric, Light-weight Delicate Fabrics, etc.	100 to 150 Cotton 50 Silk 80 Mercerised Darning Cotton	9	20	25 to 30
Fine Calicoes, Linens, Shirtings, Fine Silk Goods, etc.	80 to 100 Cotton, 50 Silk 50 Mercerised Darning Cotton	11	16	20
Plastic Materials	50 to 80 Mercerised Cotton	11	10	12
Shirtings, Sheetings, Bleached Calicoes, Silk and General Domestic Goods, Light Woolen Goods and all classes of general work	80 to 80 Cotton, 50 Silk 50 Spiko	14	12	18
All kinds of heavy Calicoes, Drill, Woolen Goods, etc.	40 to 60 Cotton	16	10	12
Tickings, Heavy Woolens, Trousers, Boys' Clothing, Corsets, Cloaks, Mantles, Heavy Coats, and Heavy Clothing generally	24 to 40 Cotton, 80 to 90 Linen	18 or 19	8	10
Bags, Coarse Cloths, Canvas, Duck, Heavy Goods of any texture	40 to 60 Linen, or very coarse Cotton	19 or 21	6	8

*When ordering needles, always specify Catalogue 2020 (15x1) and state the size and quantity required. You will obtain the best stitching results from your Sewing Machine if it is fitted with a SINGER® Needle.*



### NEEDLES AND THREAD

For perfect stitching, thread should be selected according to fabric to be stitched, and needle must be correct size for thread which must pass freely through eye of needle.

### TO SET THE NEEDLE

Select the correct needle according to the table on page 14. Be sure that needle is not blunt or bent. Raise the needle bar to its highest position and loosen thumb screw H, Fig. 13 in needle clamp. Push needle with its flat side toward the right up into needle clamp as far as it will go, then tighten the thumb screw H. A screwdriver slot is

provided for stronger clamping of needle, required for attachments driven from needle clamp hub.

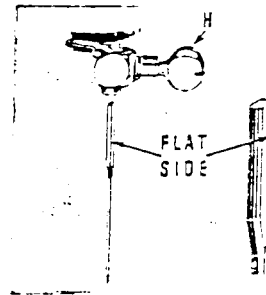

Fig. 13. To Set the Needle.

## UPPER THREADING

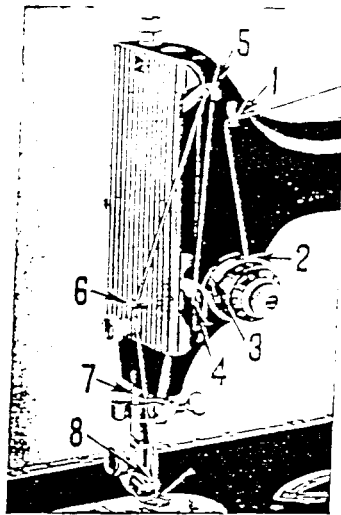

Fig. 14. Upper Threading.

See Fig. 8.

- Place spool of thread on spool pin
- Raise take-up lever 5 to its highest point
- Lead thread into thread guide 1
- Down and from right to left between tension discs 2
- Into the loop of the take-up spring 3
- Under the slack thread regulator 4 (not through the eye in the thread regulator)
- Up and from right to left through hole in take-up lever 5
- Down through guide 6 on face plate
- Down through the lower wire guide 7
- From left to right through the eye of the needle 3
- Draw about two inches of thread through the eye of the needle with which to begin sewing.

TO REMOVE THE BOBBIN

- Raise needle to its highest point.
- Draw slide plate to the left.
- Press bobbin ejector J, Fig. 15, to raise bobbin for easy removal.

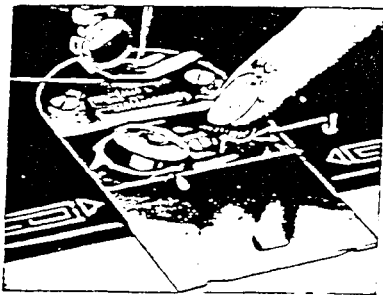

Fig. 16. Removing the Bobbin.

TO WIND THE BOBBIN

Hold hand wheel K, Fig. 16, with left hand and with right hand loosen stop motion screw L to disengage stitching mechanism.

Place empty bobbin on bobbin winder spindle, see Fig. 16.

Turn bobbin until hole in right side engages pin in spindle.

Press bobbin winder downward until latch M, Fig. 17, engages. In this position latch will hold bobbin in place.

Place spool of thread on spool pin 1.

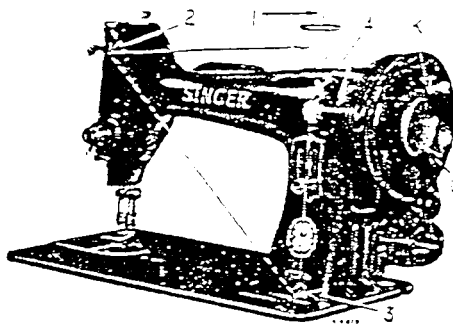

*Fig. 16. Machine Threaded for Winding the Bobbin.*

Draw thread through guide 2 on arm of machine.

Lead thread from front to rear through lower notch of guide 3.

Pass thread through upper notch of guide 3.

Thread through hole O, Fig. 17, in left side of bobbin from inside.

The end of the thread must be held by hand until it is broken off by the rotation of the bobbin.

Fig. 17 shows bobbin winder in position for winding.

When sufficient thread has been wound, the bobbin winder is automatically released.

Remove filled bobbin from bobbin winder spindle and re-tighten stop motion screw L, Fig. 16.

If thread does not wind evenly on bobbin, loosen screw which holds thread guide 3, Fig. 16.

Turn guide to left if bobbin winds high on right.

Turn guide to right if bobbin winds high on left.

When guide is properly centred, thread will wind evenly across bobbin. Tighten guide clamping screw.

If the pressure of bobbin winder pulley N, Fig. 17 against hub of hand wheel is insufficient for winding the bobbin, press down winder until latch M drops down and holds it, then loosen screw P2. With the forefinger push back upper end of slotted plate P1 as far as it will go and at the same time, with the thumb, press winder against ledge of wheel. Then tighten screw P2 securely. Afterwards raise latch to release winder from contact with hand wheel.

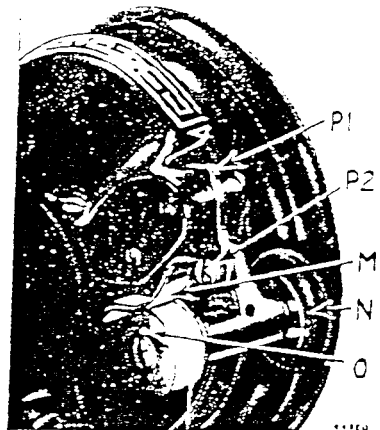

Fig. 17. Bobbin Winder Adjustment.

TO REPLACE THE BOBBIN

Hold bobbin between the thumb and forefinger of left hand, with thread leading on top from right to left, as shown in Fig. 18.

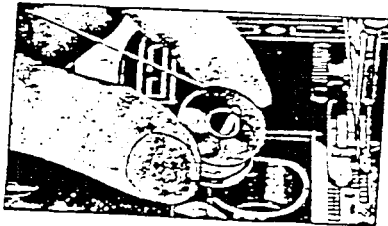

Fig. 18. Replacing the Bobbin.

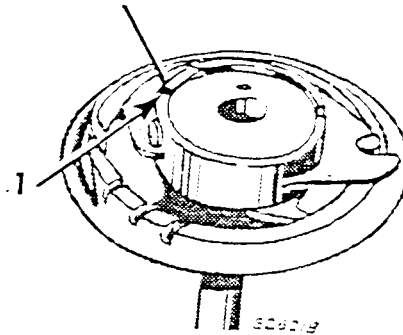

Fig. 19. Threading the Bobbin Case.

Place bobbin into bobbin case and draw thread into slot 1, Fig. 19 in the bobbin case, as shown. Draw the thread backward between the bobbin case and the tension spring until it reaches the notch 2, Fig. 20, then pull

the thread toward the right, as shown in Fig. 20. When closing the slide, place thread up through slot 3, Fig. 21, as shown.

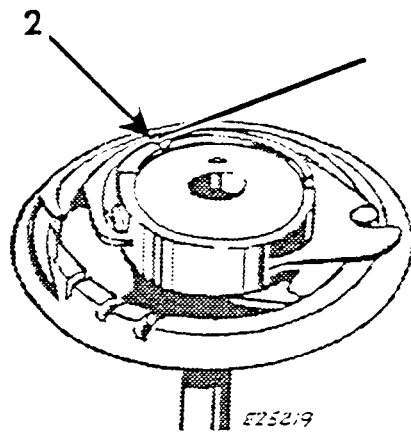

Fig. 20. Bobbin Case Threaded.

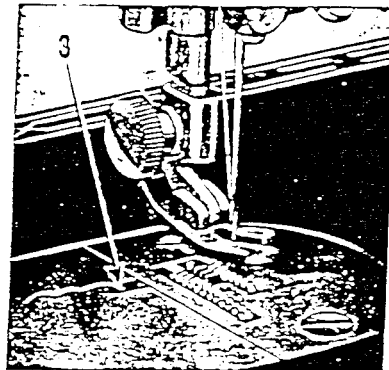
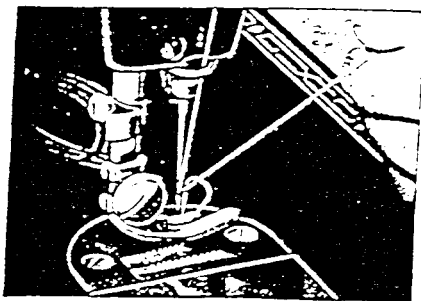

Fig. 21. Under Threading Completed.

#### TO PREPARE FOR SEWING

Have the thread take-up lever at its highest position. With the left hand, hold the needle thread, leaving it



*Fig. 22. Drawing Up the Under Thread.*

slack from the hand to the needle. Turn the hand wheel over toward you until the needle moves down and up again to its highest position, thus catching the bobbin thread. Draw up the needle thread and the bobbin thread will come up with it through the hole in the throat plate as shown in Fig. 22.

Lay both threads back under the presser foot diagonally across the feed, to the right or left, depending upon which side of the needle the material is to be located so that when the presser foot is lowered, the threads will be firmly held between the feed and the presser foot.



---

### TO START SEWING

Be sure to have thread take-up lever 5, Fig. 14 at its highest position.

Place material beneath the presser foot Q, Fig. 23, turn the hand wheel to bring the point of the needle into the material, then lower the presser foot by means of presser bar lifter R and start to sew.

Some materials, such as soft finished sheers, nylons, jerseys, tricots and other elastic and spongy textiles, require a slight amount of assistance in feeding during sewing operations.

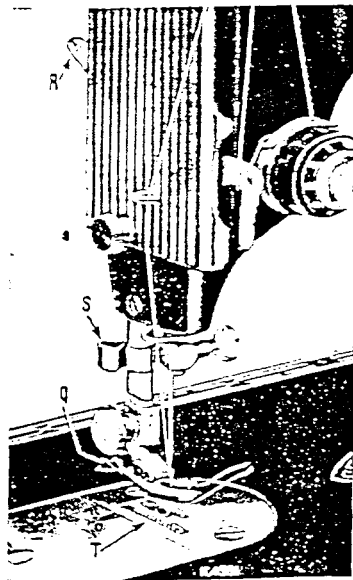

Fig. 23. To Start Sewing.

However, too much pull will stretch the seam, create irregular stitching and bend the needle. Most materials require only guiding for best sewing results.

The machine will sew its own thread when sewing from one piece of material to another. However, it is not recommended that any sewing be done with a threaded machine unless some fabric is under the presser foot.

#### TO TURN A CORNER

Stop the machine when the needle eye, making its upward stroke, is still in the fabric. Raise the presser foot and turn the work as desired, using the needle as a pivot, then lower the presser foot and resume sewing.

#### BASTING

The longest stitch, No. 6 on the stitch indicator plate, is satisfactory for basting and is easily removed by clipping every sixth stitch and withdrawing the long continuous thread. Machine basting is firmer, more even and much quicker than hand basting.

#### TO SEW BIAS SEAMS

Use a short stitch when sewing bias or curved seams to increase the elasticity of the seam and to prevent seam failure under strain. No change in tensions is required.

#### TO REMOVE THE WORK

Stop the machine with the thread take-up lever 5, Fig. 14 at its highest point. Raise the presser foot by means of presser bar lifter R, Fig. 23, draw the fabric back and to the left and sever

the threads on thread cutter S, Fig. 23. Place ends of threads under presser foot.

**CAUTION :**

When the machine is not in use, raise the presser foot by means of presser bar lifter R to prevent injury to the presser foot and the feed T, Fig. 23.

**TO REGULATE LENGTH OF STITCH**

The machine is adjustable to make from 6 to 30 stitches per inch, as indicated by the numerals on the stitch indicator plate.

The "red dot" indicator U, Fig. 24, in the slot at the left indicates the stitch setting. To regulate the length of stitch, turn thumb nut V, Fig. 24, on lever away from the stitch indicator plate as far as necessary.

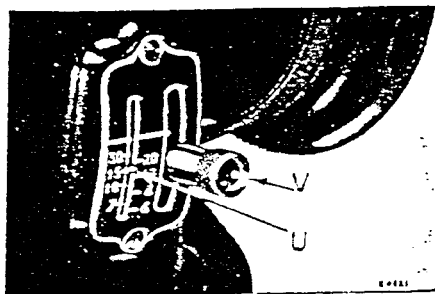

*Fig. 24. To Regulate Stitch Length.*

Move the lever at V until the "red dot" indicator U is at the desired stitch setting. Then turn thumb nut V inward until it touches indicator plate. The machine is now set to stitch the desired number of stitches per inch in a forward direction.

**TO REVERSE THE DIRECTION  
OF FEED**

For Back Tacking, raise the lever to the upper end of the indicator plate. The machine will then stitch in a reverse direction, making it easy to fasten the ends of seams.

**TO REGULATE PRESSURE ON  
PRESSER FOOT**

For ordinary sewing, the pressure of the presser foot on the material seldom requires changing. Heavy materials require more pressure than light weight materials. The pressure should be only heavy enough to prevent the material from rising with the needle and to en-

able the feed to move the work along evenly without side creeping. To increase the pressure, turn the thumb screw **W**, Fig. 25 clockwise or downward. To lighten the pressure, turn the thumb screw **W** so that it screws upward.

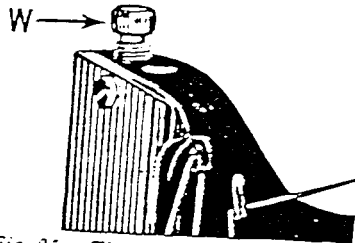

*Fig. 25. Thumb Screw for Regulating Pressure on Presser Foot.*

### THREAD TENSIONS

For perfect stitching, the tension on the needle and bobbin threads must be heavy enough to pull the threads to the centre of the thickness of the material and make a firm stitch, as shown in Fig. 26. If the needle thread lies straight along the top side of the material, the tension on the needle thread is too heavy or the tension on the bobbin thread is too light, as shown in Fig. 27. If the bobbin thread lies straight along the underside of the material, the tension on the needle thread is too light or the tension on the bobbin thread is too heavy, as shown in Fig. 28.



Fig. 26. Perfect Stitching.



Fig. 27. Imperfect Stitching.



Fig. 28. Imperfect Stitching.

### TO REGULATE NEEDLE THREAD TENSION

The tension on the needle thread can be tested only when the presser foot is down.

The numerals "0" to "9" on dial X, Fig. 29 indicate the different degrees of tension that can be obtained. The numbers do not denote size of thread or amount of tension.

When the tension has been correctly set, note the number at the indicator line Y, Fig. 29 so that this setting may be regained should the tension be altered for special work.

To increase tension, turn the thumb nut Z, Fig. 29 gradually to the right (clockwise) until the required tension

is obtained. Each higher number denotes increased tension.

To decrease tension, turn the thumb nut Z gradually to the left (counterclockwise) until the required tension is obtained. Each lower number denotes less tension.

The tension indicator Y is marked with the signs + and —, which indicate the direction in which to turn the thumb nut Z for more or less tension.

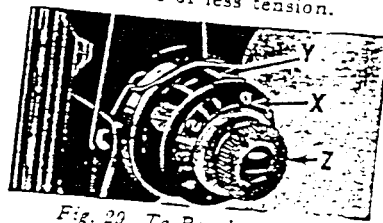

Fig. 29. To Regulate Needle  
Thread Tension.

• TO REGULATE BOBBIN  
: THREAD TENSION

The tension on the bobbin thread is regulated by the screw A, Fig. 30 which is nearest the centre of the tension spring on the outside of the bobbin case. To increase the tension, turn screw A over to the right. To decrease the tension, turn this screw to the left.

When the tension on the bobbin thread has been once properly adjusted, it is seldom necessary to change it. A correct stitch can usually be obtained by varying the tension on the needle thread.

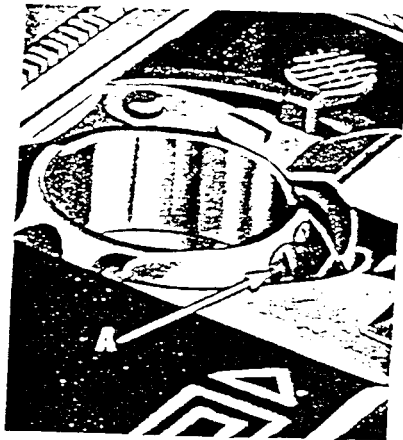

Fig. 24. Bobbin Thread Tension.

..

### TO ADJUST THE NEEDLE THREAD TENSION

Lower the presser bar and turn the numbered dial X to bring the numeral "1" opposite the centre line Y, Fig. 29 between the plus and minus signs on the tension indicator. Press the numbered dial inward as far as it will go, and turn the thumb nut Z until the pin engages one of the holes in the numbered dial. Turn the thumb nut, together with the numbered dial, to the left. This should cause the numeral

"0" to stop opposite the centre line if the tension is properly assembled. Now insert the pin of the thumb nut Z in different holes of the numbered dial until one is found which gives a slight perceptible tension on No. 50 mercerised thread when the thumb nut is turned to the extreme left and the numeral "0" is opposite the centre line. This tension gradually increases with the turn of the thumb nut to the right, providing a full range of tensions from light to heavy with one revolution of the thumb nut.



**TO ADJUST THE TENSION ON  
THE THREAD TAKE-UP SPRING**

The tension on the thread take-up spring should be just sufficient to take up the slack of the needle thread until the eye of the needle in its descent reaches the material.

**TO ADJUST THE BOBBIN THREAD  
TENSION**

First adjust the needle thread tension, as instructed on page 30. Then, using No. 50 mercerised thread in both the needle and the bobbin, and using two thicknesses of thin material under the presser foot, turn the numbered dial, by means of the thumb nut, to bring the numeral "4" opposite the centre

line. A few stitches should now be made in the material and then examined to see if the stitch is properly locked in the material. If the bobbin thread shows on top, the tension on the bobbin thread should be increased. If the needle thread shows on the bottom, the tension on the bobbin thread should be decreased.

A wide range of materials and threads can now be accommodated without further adjustment of the bobbin thread tension.

Any change in tension, required to obtain a proper stitch to suit different materials being sewn, can be made by a slight adjustment of the tension on the needle thread only.

#### TO CLEAN THE STITCH FORMING MECHANISM

After considerable use, the stitch forming mechanism of the machine may become clogged with lint and this may interfere with the perfect operation of the machine.

Occasionally remove the bobbin case from the machine, according to the following instructions, and remove any lint, etc., which has accumulated in the machine.

#### TO REMOVE THE BOBBIN CASE

*Operator Being at the Front of the Machine.*

Raise the needle to its highest position by turning the hand wheel over toward you. Draw the slide plate AA, Fig. 31

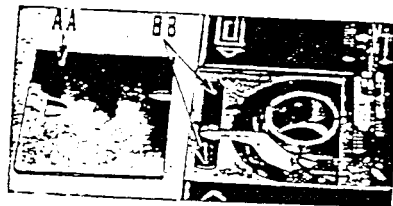

Fig. 31. Slide Plate Removed.

slightly to the left, then lift its right hand end and draw it toward the needle until it is disengaged from the spring BB in the bed of the machine.

Insert the forefinger of the left hand under the latch CC, Fig. 32. raise the latch just high enough to clear the edge at DD and then move the latch toward you.

Under no circumstances must the screw EE be loosened. The loosening of this screw will change the clearance for the thread between the bobbin case and the bobbin case position bracket.

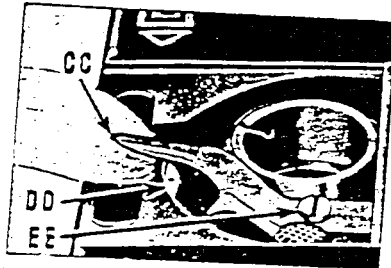

Fig. 32. Raising the Bobbin Case Latch.

Hold the bobbin case between the forefinger and the thumb of the left hand as shown in Fig. 33. Tilt the bobbin case to the left and at the same time slightly turn the right or forked end toward you so that it is moved out of engagement with the sewing hook. Then tilt the bobbin case toward the right and remove it.

## TO REPLACE BOBBIN CASE

*Operator Being at the  
Front of the Machine.*

See that the needle is raised to its highest position and that the lat in CC, Fig. 34 is raised from the slot FF, Fig. 34 and moved toward you.



*Fig. 33. Removing the Bobbin Case.*

Hold the bobbin case between the forefinger and thumb of the left hand, as shown in Fig. 33. Insert the forked end of the bobbin case under the throat of the bobbin case position bracket GG, Fig. 34. Then, with a slight twisting



*Fig. 34. Bobbin Case Position Bracket.*

motion of the bobbin case to the left and to the back, lightly press it downward until the edge of the sewing hook engages in the groove under the rim of the bobbin case.

Having set the bobbin case into the correct position, lock the latch CC, Fig. 34 in the notch FF, Fig. 34 to hold the bobbin case in place.

#### TO REPLACE SLIDE PLATE

Replace the slide plate from the right, as shown in Fig. 35, being careful to see that the two ends of the spring BB enter the grooves on the underside of the slide plate.

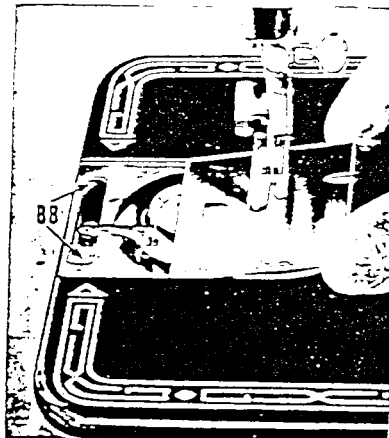

Fig. 35. Replacing Slide Plate.

## SEWING SUGGESTIONS

### Belt for Treadle Machine (99K29) :

The Belt should be only just tight enough not to slip. If too loose, shorten and rejoin.

### Breaking of Needles Might be Caused by :

1. Improper size of needle for thread and material—see page 14.
2. Bent needle.
3. Pulling of material when stitching.
4. Needle striking an improperly fastened presser foot or attachment.

5. Crossing too thick seams with too small a needle.

### Breaking of Needle Thread Might be Caused by :

1. A knot in thread.
2. Improper threading—see page 16.
3. Upper tension is too tight—see page 27.
4. Needle not pushed up as far as it will go into needle clamp—see page 15.
5. Needle blunt or bent.
6. Thread too coarse for needle—see page 14.
7. Roughened hole in throat plate.

---

8. Improper arrangement of threads to start sewing—see page 22.

**Breaking of Bobbin Thread**  
Might be Caused by :

1. Improper threading of bobbin case—see pages 20 and 21.
2. Bobbin thread tension too tight—see page 29.

**Skipping of Stitches**  
Might be Caused by :

1. Needle not pushed up as far as it

will go into needle clamp—see page 15.

2. Needle blunt or bent.
3. Needle too small for thread—see page 14.

If machine runs heavily after standing idle for a long period, apply a few drops of paraffin at all oiling places, run machine for a few minutes, then wipe clean and oil the machine—see pages 11, 12 and 13.

Free instruction for using the machine is gladly given at any

**SINGER SEWING CENTRE**

INSTRUCTIONS  
FOR USING  
ATTACHMENTS

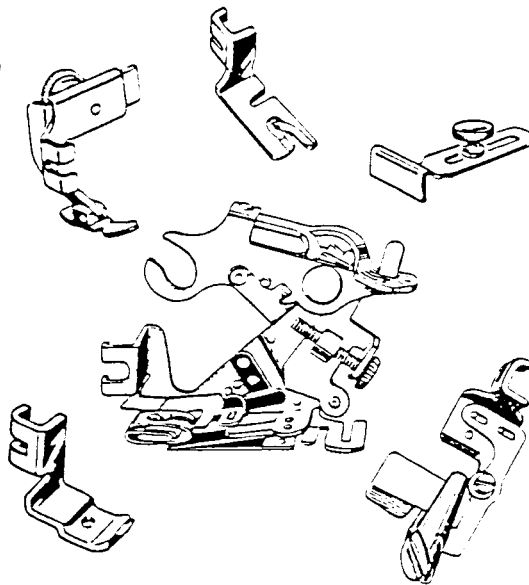



## THE FOOT HEMMER

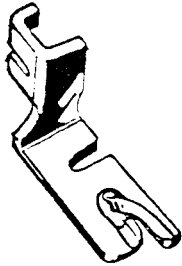

The foot hemmer forms and stitches a perfectly turned hem without basting or pressing. It is attached to the machine in place of the presser foot.

- Place the creased hem edge under the foot and take several stitches through the fold.
- Grasp the thread ends and the single fold in front of the hemmer and lift the single fold into the hemmer scroll.

Soft fabrics will enter the scroll best with the foot down, firm crisp fabrics with the foot raised.

### Applications

Fine hems	Hemming with lace
Edging ruffles	Lace insertion
Sheer seams	Lingerie finishes

### Hemming

- Form a double  $\frac{1}{8}$ " fold at the very edge of the fabric.
- Crease this fold for about 2".
- Draw the needle and bobbin threads under the hemmer.

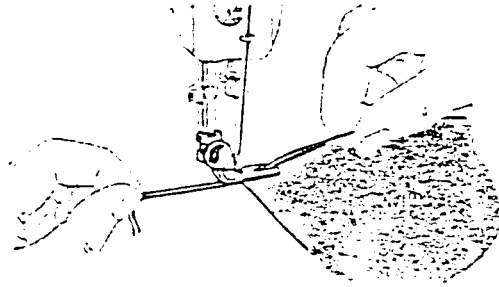

- Stitch slowly for several inches until hem is well started. Hold thread ends in back of foot with the left hand and guide the raw fabric edge into the mouth of the scroll with the right hand.

Even feeding is essential to good hemming. The same width of fabric must be kept in the scroll of the hemmer at all times.

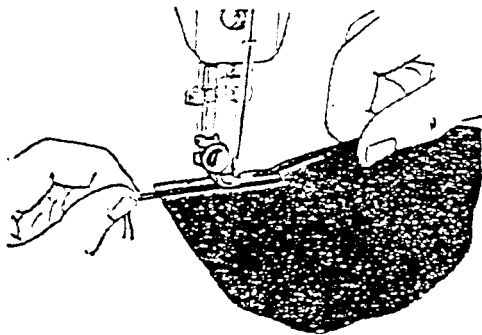

#### Hemmed Seams

Hemmed seams are often substituted for French seams where a fine narrow seam is appropriate.

- Allow a scant  $\frac{1}{4}$ " seam allowance.
- With right sides of the fabric together, place the upper layer a scant  $\frac{1}{8}$ " to the left of the lower layer.
- Insert the two fabric edges into the hemmer and proceed as for a plain hem.

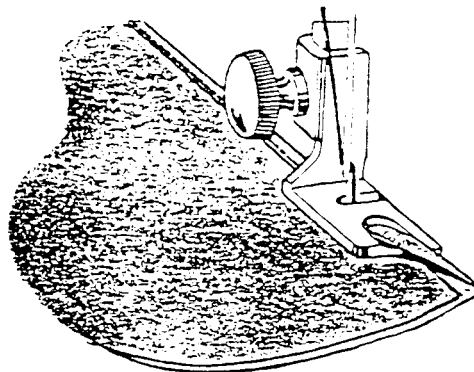

### Hemming With Lace

Most of the popular kinds of lace edging and insertion can be applied with the foot hemmer. It is an excellent way to trim children's clothes and to finish lingerie hems.

#### *Lace Applied Over Hem*

- Fold and start hem in usual way.
- Starting about 1 inch down from end of lace, place selvage under the needle, then lower the needle to hold lace firmly.
- Raise hemmer foot slightly and slip lace under back part of foot.
- Stitch slowly, guiding fabric with right hand and lace with left hand. Take care not to stretch the lace.

#### *Lace Applied Under Hem*

When using lace underneath the fold of a hem, the procedure is the same as when making a hemmed seam (page 41). Slip the lace in from the left as you would the second piece of fabric.

This method is used where a neat finish is desired on both sides of the material. 42

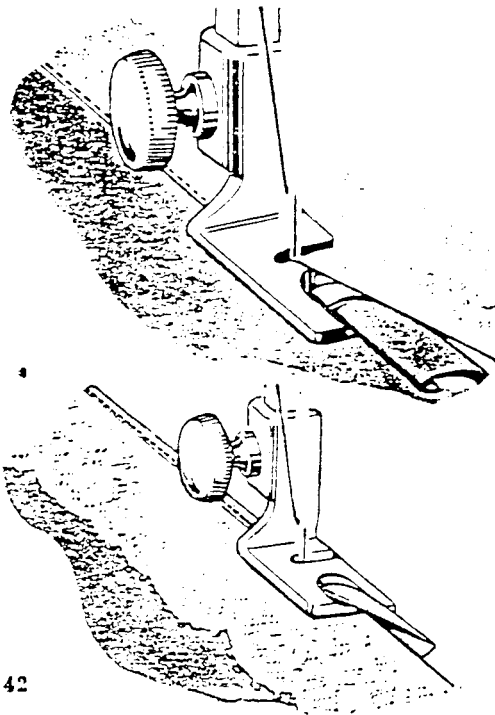

## THE BINDER

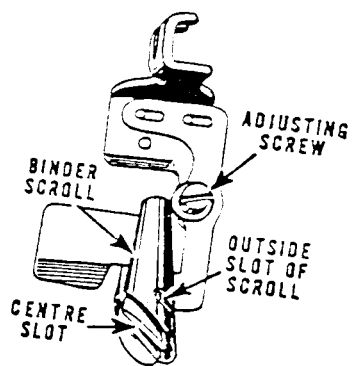

The binder is used to apply commercial binding as well as self-fabric bias to an unfinished edge.

This colourful trim is attractive when applied to children's wear, aprons and fabric furnishings. It is a practical finish for seam edges that ravel and for making bound seams.

### Inserting the Binding

Pre-folded commercial bias binding is inserted from the right into the outside slot of the binder scroll.

- Cut the binding diagonally to form along point.
- Insert the pointed end into the slot and pull through the scroll until the evenly folded edges are under the needle.

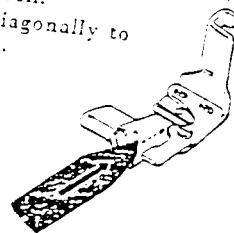

Self-fabric bias binding should be cut  $\frac{1\frac{1}{2}}{10}$ " wide on the true bias.

- Insert the unfolded binding directly into the two folds at the end of the scroll and draw it back under the needle.

As the binding passes through the scroll the raw edges are turned in.

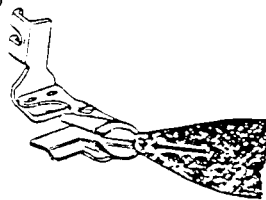

### Adjustment and Operation of the Binder

The edge to be bound is guided into the centre of the scroll. Stitching is positioned close to the edge of the binding by adjusting the scroll portion of the attachment.

- Loosen the adjusting screw and move the scroll to the right to bring the stitching closer to the binding edge. For a wider adjustment, move the scroll to the left.

Be sure that the screw is well tightened after making an adjustment.

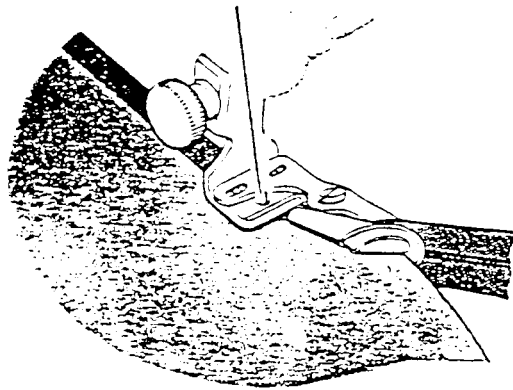
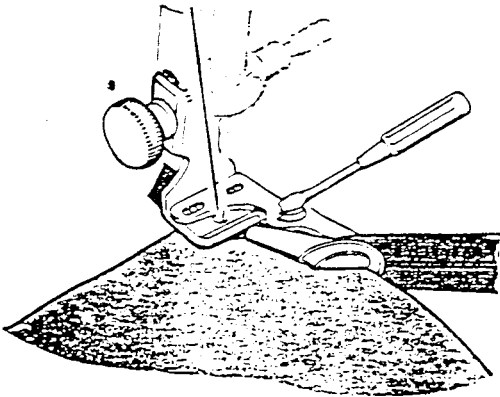

Never pull the binding as it feeds through the scroll. Allow the attachment to do the work. Merely guide the edge to be bound well into the centre of the scroll as you stitch.

### *Binding Curved Edges*

Curved edges can be bound as easily as straight edges, but require slightly different fabric handling.

### *Inside Curves*

Inside curves are straightened as they are fed into the binder. If the fabric is soft and has a tendency to stretch, reinforce the edge with a single row of stitching before binding.

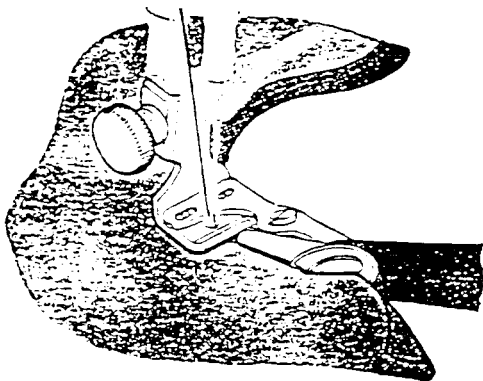

### *Outside Curves*

Outside curves tend to lead away from the centre slot of the scroil and should be guided so that a full seam width is taken at the needle point. Do not attempt to pull or straighten the fabric into the full length of the scroil.

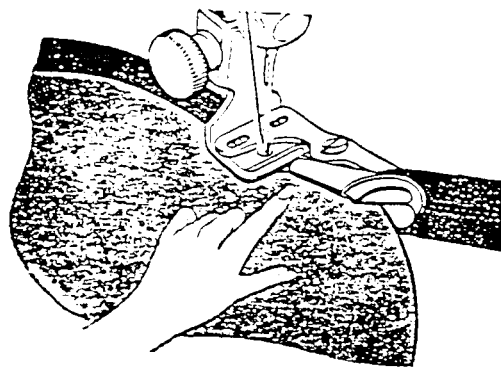

## THE GATHERING FOOT

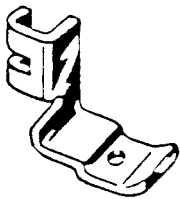

Single or multiple rows of shirring can be quickly and expertly placed with the gathering foot. Evenly spaced shirring is insured as this foot is designed to lock fullness into every stitch.

### Applications

Plain shirring  
Elastic shirring  
Shirring

Waffle shirring  
Machine smocking

Shirring is usually done on the crosswise grain of the fabric. Soft fabrics lend themselves to shirring better than firm fabrics.

The amount of fullness is very simply controlled by stitch length and degree of tension.

A long stitch produces more fullness than a short stitch. Balanced tensions are always required, but heavy tensions, both upper and lower, produce more fullness than light tensions.

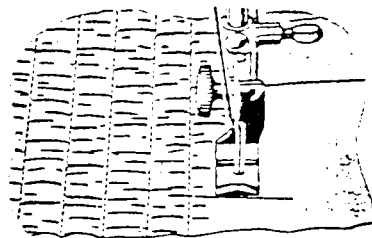

Many lovely effects are accomplished with simple rows of evenly spaced shirring. A yoke section, insert or trimming band of self-fabric affords an interesting contrast of texture when stitched with the gathering foot in rows  $\frac{1}{4}$ " apart.

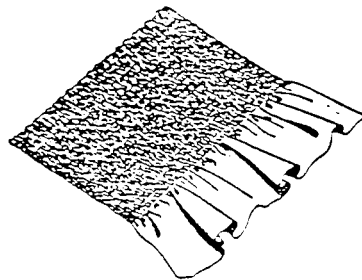

## THE RUFFLER

Occasionally apply a drop of oil to parts in movable contact.

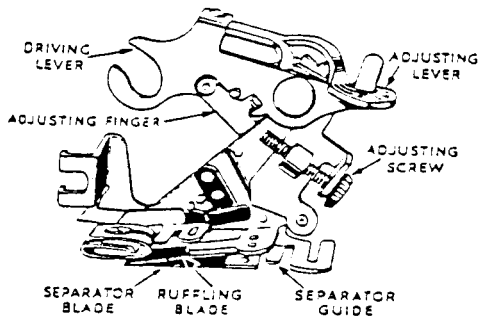

This attachment offers a simple and effective way to make gathered and pleated ruffles.

Ruffles may be made separately or made and applied at the same time.

The ruffler is attached to the machine in place of the presser foot.

### Adjusting Points

1. The adjusting lever sets the ruffler for gathers or pleats. The number 1 space setting is for gathers, and places fullness at every stitch. Numbers 6 and 12 are space settings for pleats, spacing them either 6 or 12 stitches apart. The star is for plain stitching, and is used when grouping gathers or pleats.

2. The adjusting finger is used only for pleating and affects the width of the pleat. It is thrown out of action by bringing it out of contact with the adjusting screw located at the right of the ruffler.

3. The adjusting screw regulates the fullness of gathers or pleats. When turned in (clockwise) to its limit with the adjusting finger in place, the attachment is set for its deepest pleat. When turned out (anti-clockwise) to its limit and the adjusting finger out of action, the ruffler gives only a hint of fullness.

### Activating Parts

The ruffling blade and the separator blade are of blue steel and hold the material to be gathered between them.



The ruffling blade forms the gathers or pleats by carrying the fabric to the needle according to the spacing and fullness to which the ruffer is adjusted. The separator guide is slotted to guide seam edges evenly and to separate the ruffle strip from the material to which the ruffle is attached.

#### Preparation

Raise the needle to its highest point. Locate the attachment on the machine in place of the regular presser foot, and at the same time fit the fork of the driving lever over the needle clamp screw. Make sure both the presser bar screw and the needle clamp screw are tightened securely.

#### Gathering

- Set adjusting lever on No. 1 setting.
- Throw adjusting finger out of action.
- Turn adjusting screw for amount of fullness desired.

The attachment is set for maximum fullness by turning adjusting screw in (clockwise) as far as possible; for less fullness, turn adjusting screw out (anti-clockwise).

- Set stitch length to space the fullness. A short stitch gives more fullness than a long stitch.



- Insert material to be gathered between the blue blades and through the first separator guide.
- Lower presser bar and stitch. Always test the stitch length and ruffer setting on a scrap of self fabric before proceeding with the actual work.

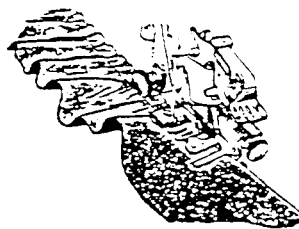

**Forming and Attaching a Ruffle in one operation—**

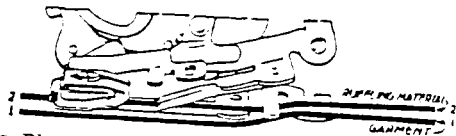

- Place ruffle strip between the two blue blades and through the first separator guide.
  - Place fabric to which ruffle is to be attached between the separator blade and the feed of the machine.
- Right sides of the fabric are placed together when the seam is to fall to the inside.
- Proceed as for plain gathering.

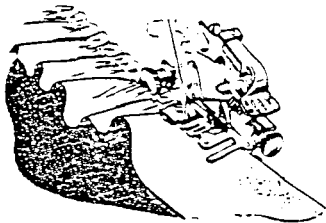

**Pleating**

- Move adjusting lever to space setting desired for pleats of either 6 or 12 stitches apart.
- Activate adjusting finger.
- For deepest pleat, turn adjusting screw in (clockwise) to its maximum. For shallower pleats, turn adjusting screw out (anti-clockwise).
- Set stitch length. A short stitch places pleats close together. A longer stitch separates the pleats for a greater distance.

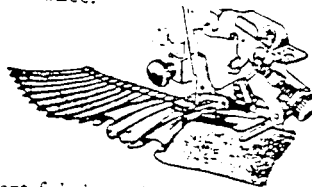

- Insert fabric to be pleated between the blue blades and through the separator guide.
- Lower presser bar and stitch.

**Group Pleating**

By using the star setting (plain stitching) alternately with the 6 or 12 setting, pleats are formed in groups. Even spacing between groups is easily accomplished by counting the number of stitches.

## THE SEAM GUIDE

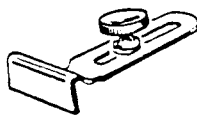

The seam guide is adjustable for spacing stitching at any distance between  $\frac{1}{8}$ " and  $1\frac{1}{8}$ " from a fabric edge. It is used in connection with the presser foot.

### Applications

Seams Stay stitching  
Top stitching—single and multiple rows

- Attach the guide to the machine with the thumb screw in either of the threaded holes at the right of the needle.
- Adjust for width desired.
- For straight edges, align guide with the presser foot.
- For curved edges, set the guide at an angle so that the end closest to the needle acts as a guide.

- For pinned seams, place the pins with the points toward the seam edge so that they nip into the fabric at the stitching line. The hinged foot will then ride freely over the points.

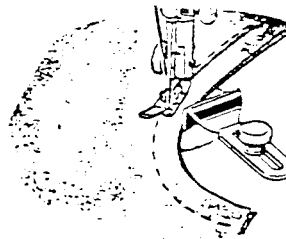
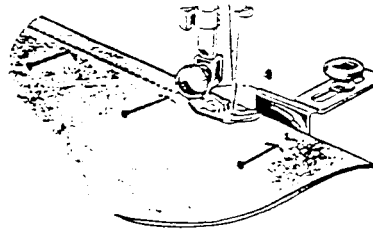

## THE ZIPPER FOOT

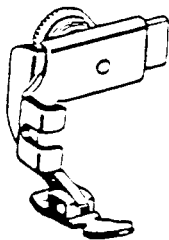

The zipper foot is designed for accurate placement of stitches close to a raised edge. The hinged feature of this foot insures even feeding over pins, heavy layers of fabric or cross seams. It is attached to the machine in place of the presser foot, and may be adjusted to either side of the needle.

### Applications

Zipper insertions  
Corded seams

Tubular cording  
Slip cover welting

### Preparation

- Attach zipper foot to machine in place of presser foot.
- Loosen zipper foot thumb screw and adjust foot to right or left of needle, as desired.

- Align the notch in the toe with the needle hole in the throat plate.
- Check adjustment by lowering needle into side notch, making sure it clears the foot.
- Lock foot in position by tightening thumb screw.

### Skirt Zipper

- Machine baste placket opening of skirt and press this seam open.
- Attach zipper foot to machine in place of presser foot.
- Position zipper foot to right of needle.
- Open zipper.
- Place zipper face down on seam allowance with edge of teeth at seam line.
- Turn the back seam allowance away from body of skirt.
- Stitch zipper tape to the seam allowance.

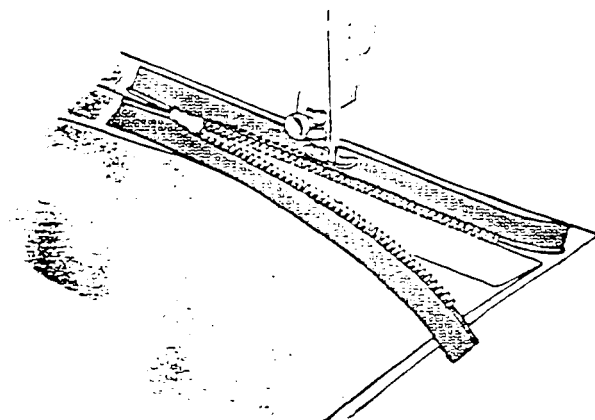

- Move foot to the left of needle.
- Close zipper and turn it face up.
- Smooth back the seam allowance at the edge of the zipper.
- Top stitch the seam allowance to the tape close to the folded edge.

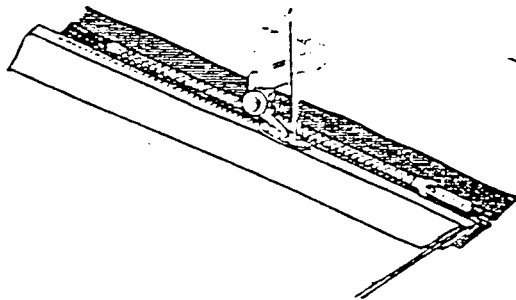

- Turn skirt to right side.
- Fold zipper to front of skirt.
- Pin in place from right side.
- Baste.
- Move foot to right of needle.
- Stitch across lower end of zipper and up to waistline.
- Remove basting.

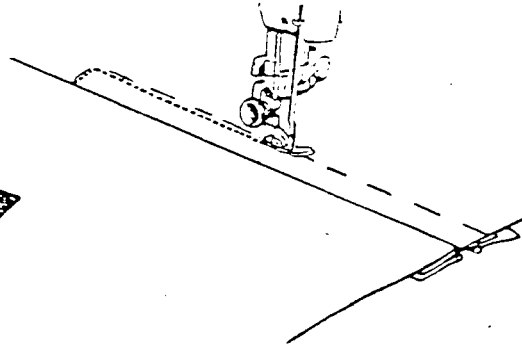

### Corded Welting

Cable cord comes in a variety of sizes and when covered with a firmly woven fabric makes a corded welting that is an excellent seam finish.

This welting is prepared in advance and then stitched into the seam. Cut a true bias strip  $1\frac{1}{4}$  inches wide, plus three times the width of the cord of either self or contrasting fabric. Sew strips together on the lengthwise grain to obtain desired length.

- Adjust zipper foot to left side of needle.
- Encase cord in bias strip, raw edges even.
- Lower presser bar.
- Stitch close to cord, using a stitch length slightly longer than for plain seaming of same fabric.
- Do not crowd stitching against cord.

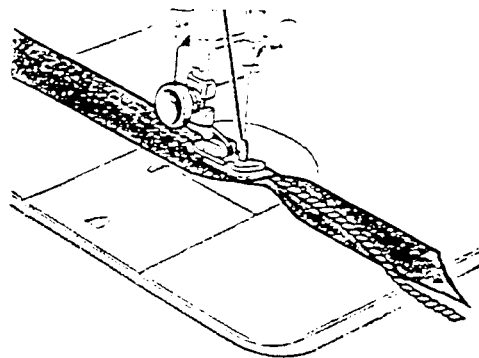
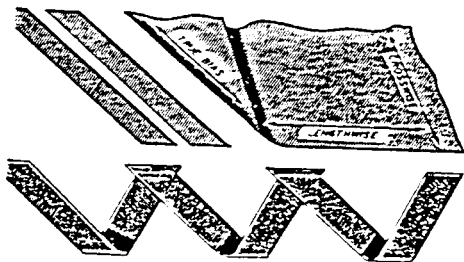

### Corded Seams

The corded seam is a typical treatment for slip covers, children's clothes, blouses and lingerie.

When cording a seam the zipper foot is usually adjusted to the right of the needle so that the bulk of the work will fall to the left.

- Attach corded welting to right side of a single seam edge, using same length stitch as used for welting (page 54). Guide edge of foot next to cord, but do not crowd.

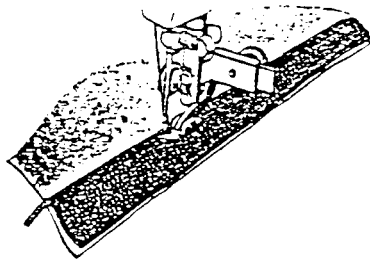

- Place attached corded welting over second seam edge, and pin or baste together.
- Keep the first stitching uppermost as a guide and position the seam under the needle.
- Stitch, this time crowding the foot against the cord.

This method produces evenly joined seam edges and tightly set welting.

Curved seams are corded as easily as straight seams, except that a shorter stitch is used. Since the seam allowance of the welting is bias, it is easy to shape it to the seam.

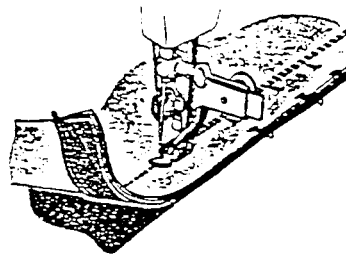



## FASHION AIDS

available for separate purchase at your local SINGER SEWING CENTRE.

### THE BUTTONHOLER

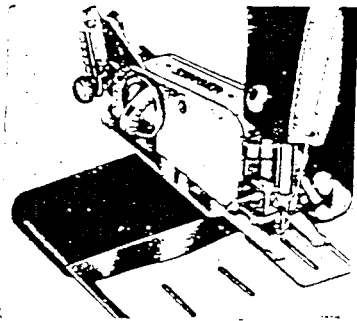

This attachment produces neat and durable buttonholes in a great variety of fabrics without any special skill on the part of the operator. The buttonholes are produced in a fraction of the time required for hand work and they are firmer and more even than those made by hand.

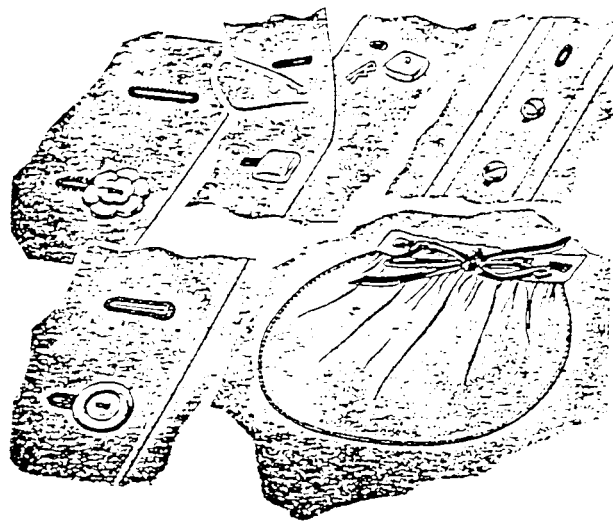

---

THE BLIND STITCHER

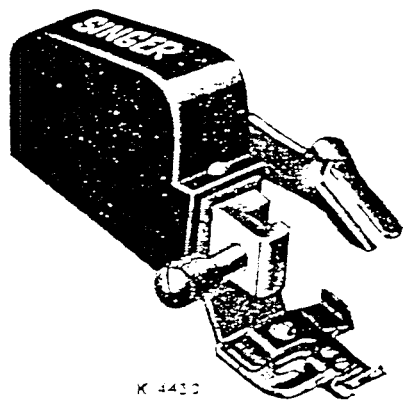

This useful SINGER attachment produces invisible hemming with perfect blind stitches on an almost unlimited variety of work such as skirts, dresses, lingerie, children's clothes, towels, curtains, sheets, table cloths and many other articles.

It is quickly attached to your sewing machine in place of the presser foot. It is easy to use and will enable you to accomplish superior invisible hemming much faster and with less effort than is possible by hand.

### THE BIAS GAUGE

The Bias Gauge is very useful (especially in the case of soft materials) when cutting bias strips from  $\frac{1}{8}$  inch to  $1\frac{3}{4}$  inches in width. This is done by placing the bias gauge upon the point of the scissors and setting the blued indicator to the width desired. The line F is the point at which to set the blued indicator for facings, the line B for binding, and the line C for cording or piping.

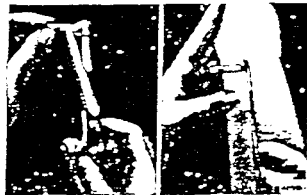

Insert the material in the gauge with the edge against the blued indicator, and hold as shown above.

Bias binding should be cut  $\frac{1}{8}$  inch wide, and to do this the indicator should be set midway between the lines F and B.

### THE EDGE-STITCHER

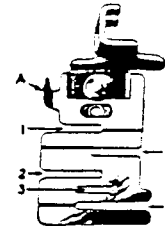

The edge stitcher provides a series of slotted guides which regulate the placement of stitches in relation to a fabric edge.

It is attached to the machine in place of the presser foot.

#### Applications

Joining lace and insertion    French seams  
Tucking with lace    Straight and pin tucks  
Facing and seam finishes    Seam piping

#### Joining Lace and Insertion

Lovely lingerie detail is simple to accomplish with the edge stitcher by joining lace insertion or alternate bands of fabric and lace. Slots 1 and 4 are used for this work. Since slot 1 overlaps

slot 4, the edge inserted into slot 1 will be the top stitched edge.

- Place the first band (the fabric band where used) into slot 1.
- Adjust lug A to position the stitching close to the edge of this band.
- Place the second band (lace) into slot 4.
- Adjust pressure to correct degree of lightness for even feeding.
- Use a short stitch length and balanced tensions.
- Hold both band edges against the end of the slots while stitching.

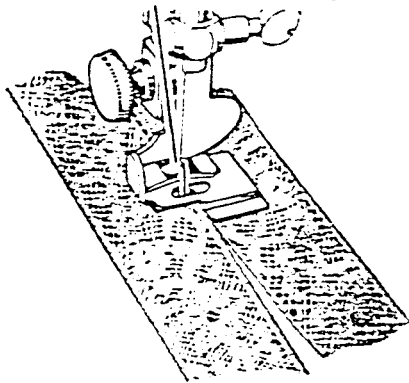

#### French Seams

The edge stitcher makes very fine French seams, so well adapted to sheer fabrics where raw seam edges must be concealed.

- Trim away seam allowances to  $\frac{1}{4}$ ".
- Lay seam edges together, right sides of fabric outward, and insert into slot 1.
- Move lug A to the left to position stitching  $\frac{1}{8}$ " from the edge.
- Stitch and press.
- Fold with right sides of fabric together and insert into slot 1.
- Move lug A to extreme left, allowing just enough margin to conceal raw edges.
- Stitch.

#### Tucking

Dainty tucks from "pin" width to  $\frac{1}{4}$ " may be produced with the edge stitcher. Tucks are usually made on the lengthwise grain of the fabric.

- Draw a single thread from the fabric, or measure from the selvage to locate the first tuck on the straight grain of the fabric.

- For succeeding tucks, crease fabric or draw a thread at distance desired from previous tuck.
  - Press tuck folds before stitching.
  - To make "pin" tucks, insert the tuck fold in slot 1 and adjust lug A to locate stitching a pin width from the fold.
  - To make  $\frac{1}{4}$ " tucks, insert the tuck fold into slot 3, and move lug A to its extreme left position.
- Use a short stitch length and perfectly balanced tensions.

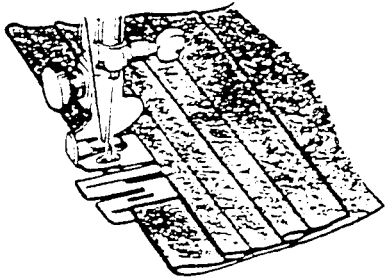

### THE QUILTER

The Quilter, designed with a short, open foot and an adjustable and removable space guide, is especially well adapted to stitching lightly padded materials. The light padding is basted to the underside of the fabric and may be of outing dannel, canton dannel, sheet wadding or light wool interlining.

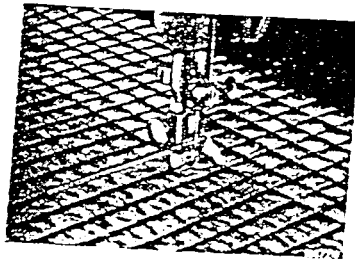

Replace the presser foot with the Quilter. Adjust the space guide for the width between stitching lines. The space guide may be used to the right or left of the needle.

## THE ADJUSTABLE HEMMER

To Make Hems  
from 3/16 to 15/16 Inch Wide

1. Attach adjustable hemmer to presser bar in place of presser foot.
2. Pull up bobbin thread as instructed on page 22.
3. Loosen thumb screw on hemmer and move scale until pointer registers with number of desired width of hem. (No. 1 indicates the narrowest hem and No. 3, the widest.) Then tighten thumb screw.
4. Place cloth in hemmer and draw it back and forth until hem is formed as shown.
5. Draw end of hem back under needle, lower presser bar and start to sew.
6. Guide sufficient cloth into hemmer to turn hem properly.

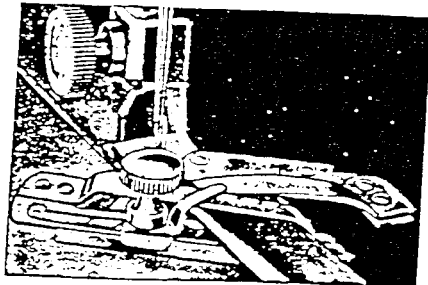

## THE ADJUSTABLE HEMMER

### WIDE HEMMING

- To make a hem more than  $\frac{1}{2}$  inch wide, loosen thumb screw in hemmer and move scale to right as far as it will go, then swing it toward you as shown and tighten thumb screw. Fold and crease down a hem of the desired width, pass fold under extension at right of hemmer, and the edge into folder as shown and proceed to stitch the hem.

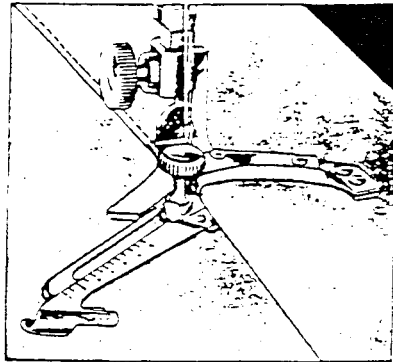

### THE TUCKER

The Tucker is a time-saver for making tucks up to one inch in width. Two adjustable scales are provided, the smaller near the needle is numbered from 1 to 3, expressing in eighths of an inch the width of the tuck. The larger scale expresses in quarter inches the spacing between tucks.

Set the tuck scale first for the width of tuck. The space scale is then adjusted using the needle as an indicator for the spacing between tucks. When both scales are set at the same number, blind tucks result. That is, the fold of one tuck just touches the stitching line of the next. When additional space between tucks is desired, adjust the space scale to a point beyond the tuck scale reading equal to the spacing desired, expressed in quarters of an inch. Thus half-inch tucks spaced a half inch apart require a tuck scale setting of 4, and a space scale setting of 5.

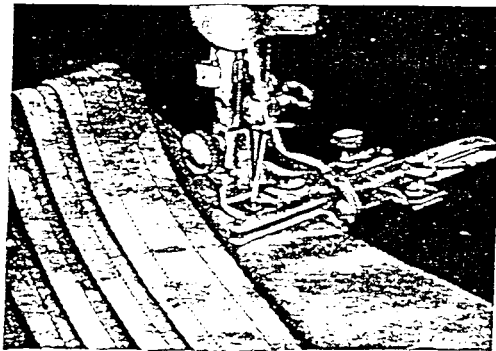



### DARNING OR EMBROIDERING

While darning and embroidery can be done on the machine when threaded for regular sewing, the use of feed cover plate Y, No. 32622, is recommended, as movable contact with the feed in some cases might interfere with the handling of the work.

Do not change the adjustment of the feed dog in any way, as it is essential that its position should remain as originally fixed.

*Machine Threaded for  
Darning and Embroidery.*

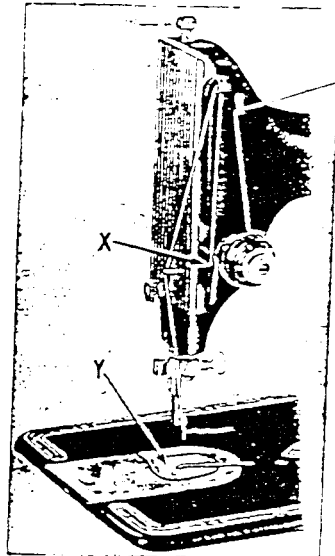

When the feed cover plate Y is used, it is necessary to lead the needle thread through the eye in the thread regulator X at the left of the tension discs and not under the thread regulator. With this exception, the threading is the same as for regular sewing (see Fig. 14, page 16).

Remove the presser foot and let down the presser bar lifter to restore the tension on the needle thread, which is released and inoperative when the lifter is raised.

To attach the feed cover plate, draw to the left the slide that covers the bobbin case and insert the downwardly projecting hooks on the cover plate under the edge of the throat plate and push it to the right. After bringing the hole at the right of the cover plate in line with the hole in the throat plate, press the cover into position and close the slide.

A feed cover plate is not included in the regular set of attachments, but is on sale at all SINGER Sewing Centres.

THE IMPORTANCE OF USING SINGER NEEDLES  
AND SINGER OIL FOR YOUR SEWING MACHINE

NEEDLES

You will obtain the best stitching results from your sewing machine if it is fitted with a SINGER Needle.

SINGER Needles and their Containers are marked with the Company's Trade-mark SINGER\* or SIMANCO\* and can be purchased from any SINGER Sewing Centre.

USE SINGER OIL ON MACHINE

Knowing from many years' experience the great importance of using good oil, SINGER sells an extra quality machine oil, especially prepared for sewing machines.

## INDEX

	Page		Page
Attachments		FASHION Aids	56
Binder	43	Adjustable Hemmer	61
Foot hemmer	39	Bias Gauge	58
Gathering Foot	46	Blind Stitcher	57
Ruffler	47	Buttonholer	56
Seam Guide	50	Edge-Stitcher	58
Zipper Foot	51	Quilter	60
Basting	24	Tucker	63
Bobbin, removing	17	Feed, reversing direction	26
Bobbin, replacing	20	Hand Attachment	8
Bobbin case, removing	32	Light	5
Bobbin case, replacing	34	Machine working heavily	37
Bobbin case, threading	20	Motor	4
Bobbin thread tension, regulating	29	Needle breakage	36
Bobbin winding	17	Needle chart	14
Cleaning stitch forming mechanism	32	Needles and thread	15
Darning and Embroidery	64	Needle, setting in needle clamp	15
Electrical information	4		

INDEX—(contd.)

	Page		Page
Needle thread tension, regulating .....	23	Sewing suggestions .....	36
Oiling the machine .....	11	Starting to sew .....	23
Preparing to sew .....	22	Stitch length, regulating .....	25
Pressure on presser foot, regulating .....	26	Thread breakage .....	36
Removing the work .....	24	Thread tensions .....	27
Rust damage, prevention of .....	10	Treadle operation .....	9
Service, SINGER .....	3	Turning a corner .....	24
Setting the needle .....	15	Upper threading .....	16
Sewing bias seams .....	24	Winding the bobbin .....	17

TO ALL WHOM IT MAY CONCERN :

The improper placing or renewal of the Trade Mark "SINGER" or any other of the Trade Marks of The Singer Manufacturing Company (all of which are duly Registered Trade Marks) on any machine that has been repaired, rebuilt, reconditioned, or altered in any way whatsoever outside a SINGER factory or an authorised SINGER agency is forbidden.

---

## FOR YOUR PROTECTION

Always look for the famous Red "S" and SINGER trademarks for authorized sales and service.

When your machine needs servicing, call your SINGER SEWING CENTRE and be sure of warranted SINGER parts and service.

See address in classified telephone directory listed only under

SINGER SEWING MACHINE COMPANY



# Instructions For Using SINGER\* SEWING MACHINES 99K & 185K

## Needles and Thread—

Use needles Catalogue 2020 (15 x 1), in sizes 11, 14, 16 and 18. You will obtain the best stitching results from your sewing machine if it is fitted with a SINGER needle.

Thread should be selected according to the fabric to be stitched. Needle must be of correct size for thread to pass freely through eye of needle.

### To Set the Needle—

- Raise needle bar to its highest position.
- Loosen needle clamp thumb screw and insert needle (flat side to the right) up into needle clamp as far as it will go.
- Tighten needle clamp screw.

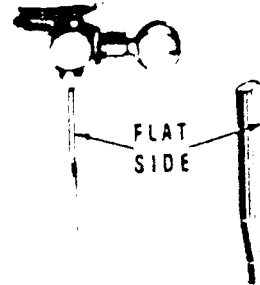

Fig. 1. To Set the Needle

### To Thread the Needle—

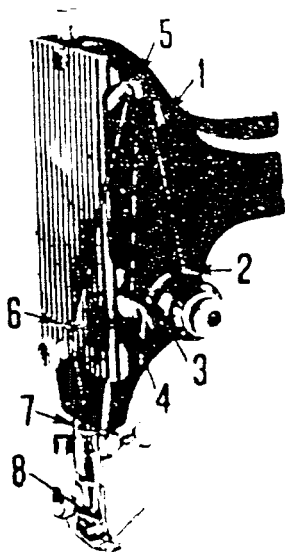

Fig. 2. Upper Threading

- Raise take up lever 5 to highest point.
- Place spool of thread on spool pin.
- Lead thread into thread guide 1,
  - Down and from right to left between tension discs 2.
  - Into loop of thread take-up spring 3
  - Under slack thread regulator 4 (not through eye in thread regulator)
  - Up and from right to left through hole in take-up lever 5
  - Down through guide 6 on face plate
  - Down through lower wire guide 7.
- Thread from left to right through eye of needle 8.
- Draw about two inches of thread through eye of needle with which to begin sewing.

### To Remove the Bobbin—

- Raise needle to its highest point.
- Open slide plate.
- Press bobbin ejector J and lift out bobbin.

Fig. 3. Removing the Bobbin

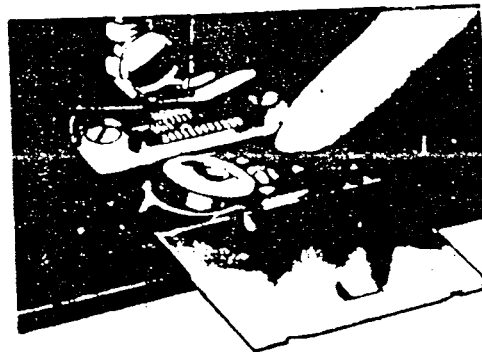

DO NOT RETURN TO STATIONARY DEPARTMENT



### To Wind the Bobbin—

- Hold hand wheel **K** with left hand, and with right hand, loosen stop motion screw **L**.
- Place bobbin **4** on spindle.
- Press bobbin winder down against hand wheel.
- Place spool of thread on spool pin **1**.
- Lead thread through guide **2** on arm of machine.
- Pass thread through lower notch of guide **3** from front to back and through upper notch from back to front.
- Lead thread from right to left through hole in left side of bobbin.
- Hold end of thread and start machine. (End of thread will break off after a few coils have been wound on bobbin.)

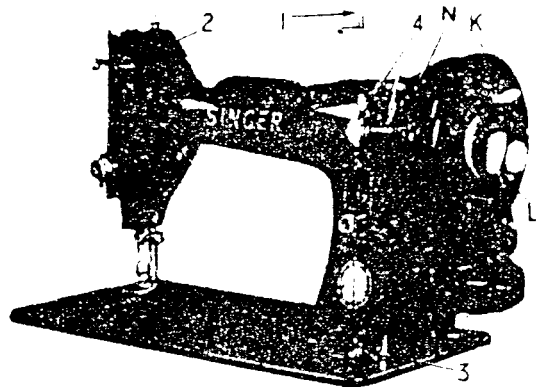

Fig. 4 Winding the Bobbin

### When Bobbin is Full—

- Stop machine, lift bobbin winder away from hand wheel and remove bobbin. Tighten stop motion screw **L**.

### If the Bobbin Does not Wind Evenly—

- Loosen screw which holds thread guide **3** to bed and move guide to right or left as required. Then tighten screw. If pressure of bobbin winder pulley against hand wheel is insufficient for winding bobbin, loosen screw **N**, press bobbin winder pulley against hand wheel and tighten screw **N**.

### To Replace the Bobbin and Thread the Bobbin Case—

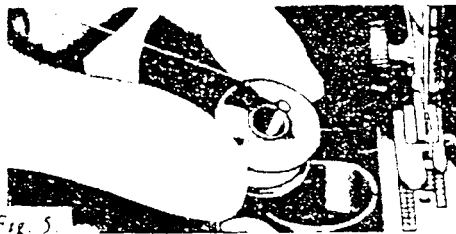

Fig. 5.

- Hold bobbin so that thread leads off in direction shown.

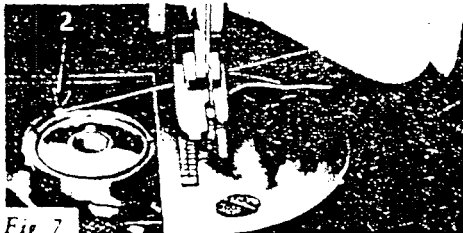

Fig. 7.

- Draw thread between case and tension spring until it reaches notch **2**.
- Pull about 3 inches of thread across bobbin.

### To Prepare for Sewing—

- Turn hand wheel over toward you so that needle enters throat plate and brings up the bobbin thread.

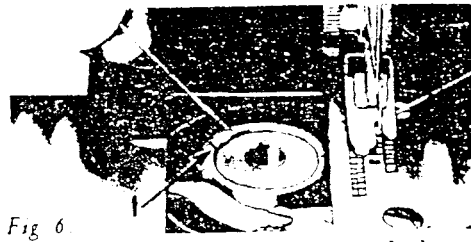

Fig. 6.

- Place bobbin in case and draw thread into slot **1**.



Fig. 8.

- Close slide plate, allowing thread to enter notch in slide plate.

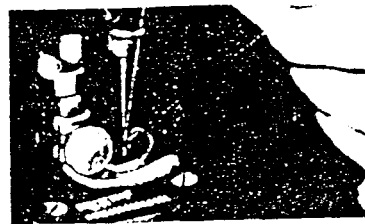

Fig. 9. Drawing Up the Bobbin Thread

**To Regulate Length of Stitch—**  
The "red dot" indicator U, Fig. 10, in the slot at the left indicates the stitch setting.

- Turn thumb nut to left. Move lever at V until "red dot" indicator U is at desired stitch setting.
- Turn thumb nut V to right until it rests against indicator plate.

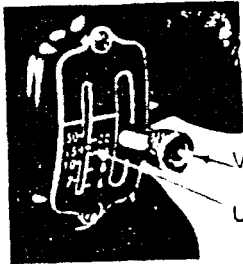

Fig. 10

To reinforce a seam, raise stitch indicator lever to its highest position. The machine will then stitch in a reverse direction, making it easy to "back tack!"

**To Regulate Pressure on Presser Foot—**

- To decrease pressure, turn thumb screw up.
- To increase pressure, turn thumb screw down.

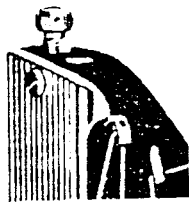

Fig. 11

For ordinary sewing, pressure of the presser foot on the material seldom requires changing. Heavy materials require more pressure than light materials. Pressure should be only heavy enough to move the work along evenly.

**To Regulate Needle Thread Tension—**

Numerals on indicator X, Fig. 12, denote different degrees of tension. When tension has been correctly set, note number at line Y so that this setting may be regained should the tension be altered for special work.

- To increase tension, turn thumb nut Z to higher number.
- To decrease tension, turn thumb nut Z to lower number.

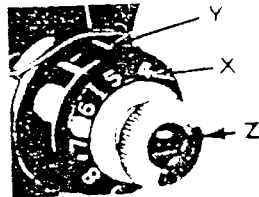

Fig. 12

**To Regulate Bobbin Thread Tension—**

Tension on bobbin thread is regulated by screw A, Fig. 13, nearest centre of tension spring. Turn screw A over to right to increase tension; turn screw to left to decrease tension.

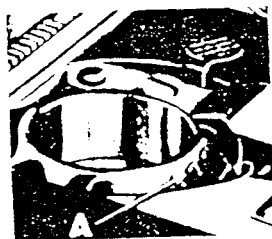

Fig. 13

A perfectly formed stitch results when both tensions are balanced so that the needle and bobbin threads are drawn equally into the fabric.



Fig. 14 Perfect Stitching



Fig. 15 Too tight Stitching

Needle thread tension too tight or Bobbin thread tension too loose.



Fig. 16 Imperfect Stitching

Bobbin thread tension too tight or Needle thread tension too loose.

**Care and Maintenance of Your**

## SINGER 99K & 185K

When in regular use the machine should be cleaned periodically.

**To Remove and Replace Bobbin Case—**

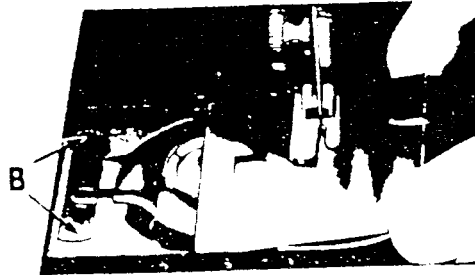

Fig. 17 Slide Plate Removed

- Raise needle and presser foot.
- Draw slide plate to left.
- Remove bobbin from case.
- Lift edge of slide plate and draw it to the right until it is disengaged from spring B.



Fig. 18 Removing Bobbin Case

- Lift and move latch C to position shown.
- Grasp bobbin case as shown.
- Tilt case to left and raise forked end above bracket G.
- Turn forked end toward you, then lift out bobbin case.

### After Cleaning—

- Replace bobbin case with its fork straddling bracket G.
- Twist case to the left, then gently press down and back until edge of sewing hook engages groove under rim of bobbin case.
- Return latch C to its original position.

### To Oil the Machine—

- Apply a drop of oil to each of the places indicated in Figs. 19, 20 and 21.

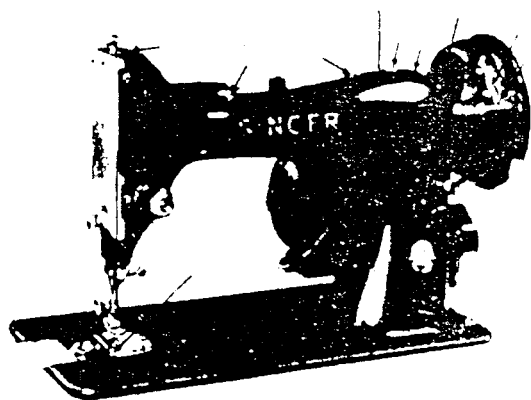

Fig. 19

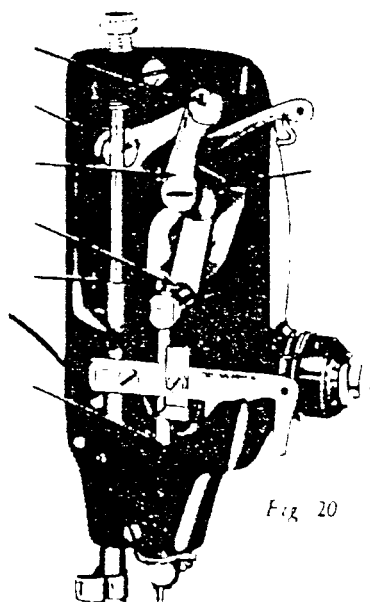

Fig. 20

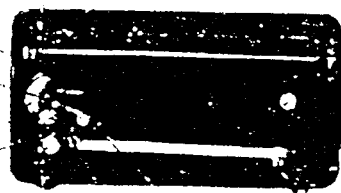

Fig. 21

CHART SHOWING THE RELATIONSHIP OF TYPES OF FABRICS, THREAD AND NEEDLE SIZES AND MACHINE STITCHES TO THE INCH

TYPES OF FABRIC	THREAD SIZES	NEEDLE SIZES	MACHINE STITCHES PER INCH	
			Inside Seams	Top Stitching
Very thin Silk, Muslin, Cambric, Light-weight Delicate Fabrics, etc.	100 to 150 Cotton 50 Silk, 80 Mercerised Darning Cotton	9	20	25 to 30
Fine Calicoes, Linens, Shirtings, Fine Silk Goods, etc.	80 to 100 Cotton, 50 Silk, 50 Mercerised Darning Cotton	11	16	20
Plastic Materials	50 to 80 Mercerised Cotton	11	10	12
Shirtings, Sheetings, Bleached Calicoes, Silk and General Domestic Goods, Light Woollen Goods and all classes of general work	60 to 80 Cotton, 50 Silk, 50 Syiko	14	12	18
All kinds of heavy Calicoes, Drill, Woollen Goods, etc.	40 to 50 Cotton	16	10	12
Tickings, Heavy Woollens, Trousers, Boys' Clothing, Corsets, Cloaks, Mantles, Heavy Coats, and Heavy Clothing generally	24 to 40 Cotton, 60 to 80 Linen	18 or 19	8	10
Bags, Coarse Cloths, Canvas, Duck, Heavy Goods of any texture	40 to 60 Linen, or very coarse Cotton	19 or 21	6	8

When ordering needles, always specify Catalogue 2020 (15x1) and state the size and quantity required. You will obtain the best stitching results from your Sewing Machine if it is fitted with a SINGER® Needle.

HISTORICAL COPY