

SINGER

246-2

USE ONLY "SINGER" OILS and LUBRICANTS

*They insure freedom from lubricating trouble and give
longer life to sewing equipment*

FOR CLASS 246 MACHINES

MANUFACTURING SEWING MACHINE OIL—LIGHT GRADE

Made especially for Class 246 Machines, and meets all requirements.

OTHER "SINGER" LUBRICANTS

MOTOR OIL

For oil-lubricated motors, power tables, transmitters and machinery in general.

STAINLESS THREAD LUBRICANT

For lubricating the needle thread of sewing machines for stitching fabrics or leather where a stainless thread lubricant is required.

NOTE: All of the above oils are available in 1 quart, 1 gallon and 5 gallon cans or in 55 gallon drums.

BALL BEARING LUBRICANT

This pure grease is specially designed for the lubrication of ball bearings and ball thrust bearings of motors and electric transmitters, ball bearing hangers of power tables, etc. **Furnished in 1 lb. and 4 lb. tins.**

Copyright, U. S. A., 1947, by The Singer Manufacturing Company
All Rights Reserved for all Countries

ADJUSTERS MANUAL FOR SINGER SEWING MACHINE 246-2

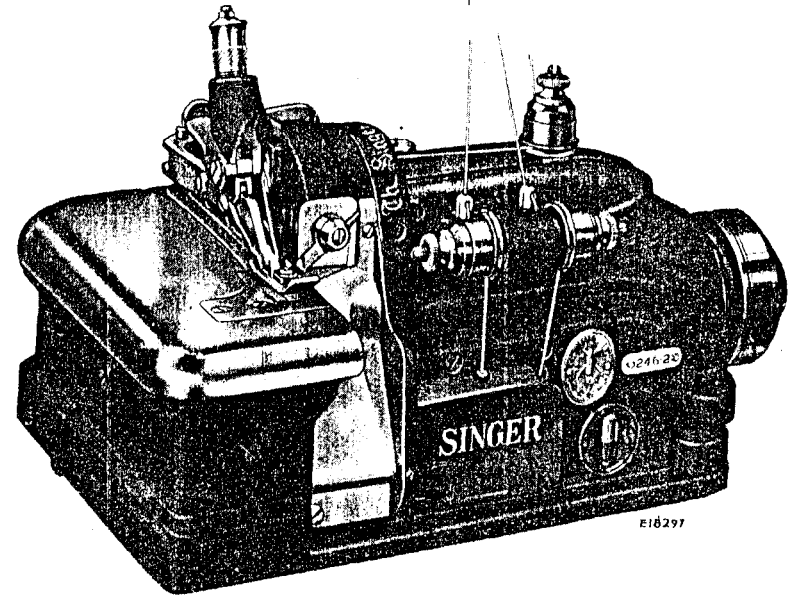

FOR TRIMMING AND OVEREDGING IN ONE OPERATION

AUTOMATIC OILING SYSTEM

CAUTION: Special attention is called to the lubricating instructions on page 4

THE SINGER MANUFACTURING CO.

TO ALL WHOM IT MAY CONCERN:

The improper placing or renewal of the Trade-Mark "SINGER" or any other of the Trade-Marks of The Singer Manufacturing Company (all of which are duly Registered Trade-Marks) on any machine that has been repaired, rebuilt, reconditioned, or altered in any way whatsoever outside a Singer factory or an authorized Singer agency is forbidden.

THE IMPORTANCE OF USING GENUINE "SINGER" PARTS AND NEEDLES IN "SINGER" MACHINES

The successful operation of "SINGER" machines can only be assured if genuine "SINGER" parts and needles are used. Supplies are available at all Singer Shops for the Manufacturing Trade, and mail orders will receive prompt attention.

Genuine "SINGER" Needles should be used in "SINGER" Machines. These Needles and their Containers are marked with the Company's Trade Mark "SIMANCO." 1

Needles in Containers marked "FOR SINGER MACHINES" are NOT "SINGER" made needles. 2

DESCRIPTION

Machine 246-2 has a trimmer, one needle and two loopers and makes the three-thread purl-on-the-edge stitch (Federal Stitch Type #505). It is designed for serging trousers and for simultaneous trimming and stitching of pockets, dress shields, etc., of muslin, rayon, light denim, flannel and other fabrics.

SPEED

The maximum speed recommended for this machine is 5500 stitches per minute. The machine should be run slower than the maximum speed until the parts which are in movable contact become glazed by their action upon each other. For long runs, a maximum speed of 5000 stitches per minute is recommended.

When the machine is in operation, the balance wheel should always turn over from the operator.

TO SET UP THE MACHINE

See Fig. 2

Place the machine with its base on the table so that the belt groove of the balance wheel is in line with the belt groove of the driving pulley and draw the outline of the base of the machine on the table. Also spot position of hole E directly below presser foot lever X, Fig. 8, page 7.

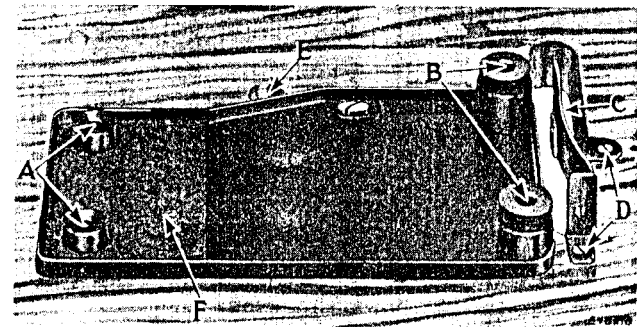

Fig. 2. Installation of Machine Base

Remove machine from its base. Using the machine base and the belt guard as templates, spot and drill six holes in the table for the six wood screws as shown at A, B and D. Bore hole, E, for chain from foot lifter to presser foot lever.

Fasten the base to the table, by means of two #6 Flat Head 1 inch wood screws at A and two #8 Round Head 3/4 inch wood screws at B. Then fasten the belt guard C to the table with two #7 Flat Head 3/4 inch wood screws at D.

After making sure that the felt cushion F is in place, set the machine on the rubber cushions at A and B on the base.

TO OIL THE MACHINE

See Fig. 3

After the machine is installed and before starting the machine, apply **MANUFACTURING SEWING MACHINE OIL—LIGHT GRADE**, sold only by the Singer Sewing Machine Company, to the oil filler cup **G** on top of the machine, filling the oil reservoir until the oil sight gauge **H** indicates that it is half full.

Thereafter, check the oil gauge **H** daily before starting the machine and maintain the oil level at the midpoint of the gauge. See X-Ray view of machine on pages 12 and 13.

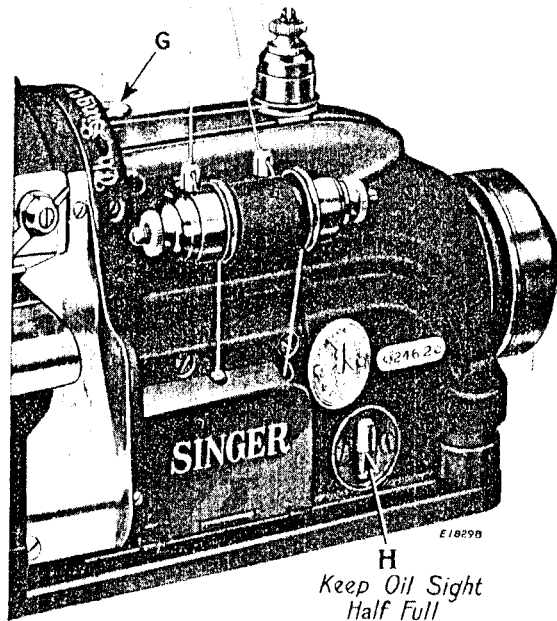

Fig. 3. Oiling

NEEDLES AND THREAD

Needles for this machine are of curved blade, Class and Variety 151x1, and are made in sizes 9, 11, 14, 16 and 18. Special sizes will be made on request.

The size of the needle to be used should be determined by the size of the thread, which must pass freely through the eye of the needle. The use of rough or uneven thread, or thread which passes with difficulty through the needle eye, will interfere with the proper formation of the stitch.

Orders for needles must specify the quantity required, the size number, also the **Class** and **Variety** numbers, separated by an **x**.

The following is an example of an intelligible order:

"100 No. 9, 151x1 Needles."

The best stitching results will be obtained in using the needles furnished by the Singer Sewing Machine Company.

TO SET THE NEEDLE

See Fig. 4

Turn the balance wheel over from the operator to move the needle carrier **Z** up to its highest position. Raise the presser bar lever **J** to disengage the presser bar **K**, and swing presser bar **K** out to the left.

With tweezers, insert the needle through the needle carrier **Z** as far as it will go against the stop **O**, then securely tighten the nut **M**.

THREADING

See Fig. 4

For convenience in threading, raise the presser bar lever **J**, and swing the presser bar **K** out to the left. Then swing the cloth plate out to the left and open the front cover plate **P**, Fig. 8.

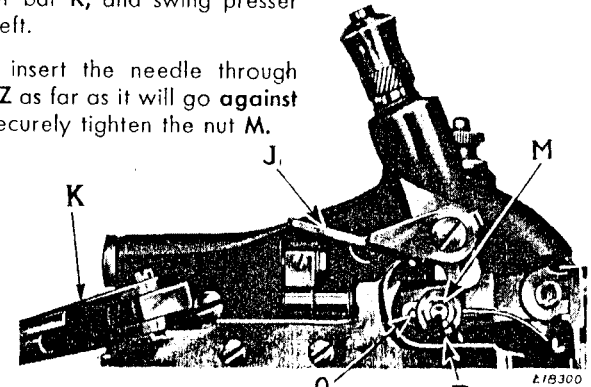

Insert Needle against Stop

Fig. 4. Setting the Needle

TO THREAD THE UNWINDER

See Fig. 5

Pass the needle thread from the spool **N**, over from back to front through loop **N1**, down and from top to bottom through eyelet **N2**, and from top to bottom through eyelet **N3**.

Pass the right looper thread from the spool **R**, over from back to front through loop **R1**, down and from top to bottom through eyelet **R2**, and from top to bottom through eyelet **R3**.

Pass the left looper thread from the spool **L**, over from right to left through loop **L1**, down and from top to bottom through eyelet **L2**, and from top to bottom through eyelet **L3**.

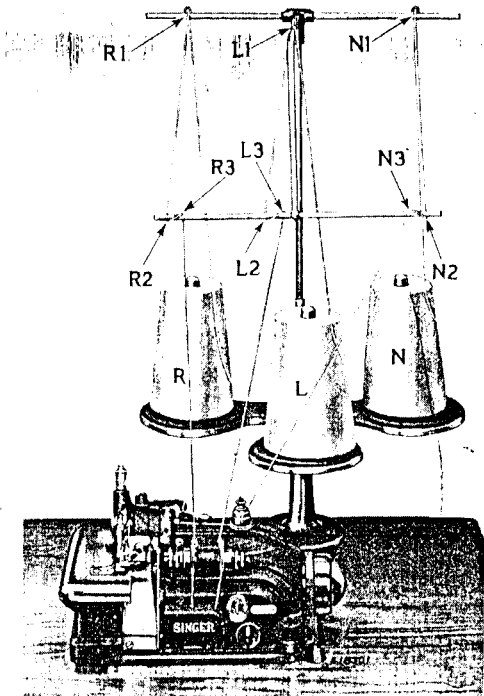
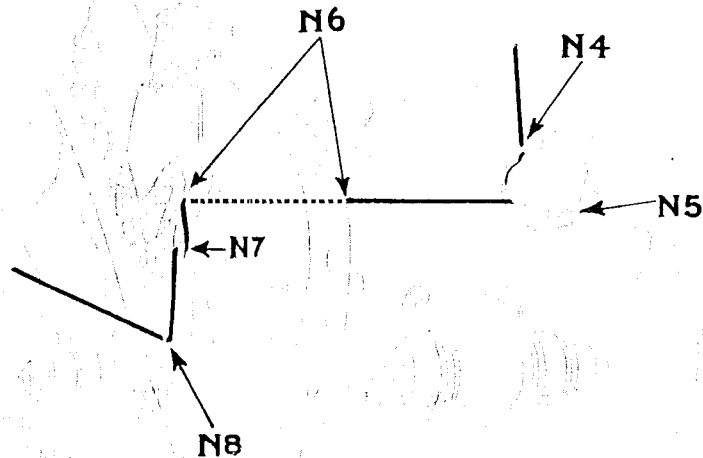

Fig. 5. Threading the Unwinder

TO THREAD THE NEEDLE

See Fig. 6

Lead the thread from the eyelet N3, Fig. 5 on the unwinder, down, and from back to front through the eyelet N4 behind the tension discs, then pass the thread clockwise between the tension discs N5, then pass the thread clockwise between the tension discs N5.



E18302

Fig. 6. Threading the Needle

Turn the balance wheel over from you until the needle reaches its highest position, then, using the threading wire, shown in Fig. 7, guide the thread from right to left through the tube N6. Remove the thread from the threading wire and pass it up and from right to left through the eyelet N7.

Pass the thread from the eyelet N7, down, and from front to back through the needle eye N8.

Draw about 2 inches of thread through the needle eye, with which to commence sewing.



Fig. 7. Threading Wire

TO THREAD THE RIGHT LOOPER

See Figs. 8, 9 and 10

CAUTION: Before threading the right looper, always be sure that there is no loop caught on the looper, as shown in Fig. 9. If this loop of the left looper thread is not removed before threading the right looper, the left looper thread will break at the instant the machine is started.

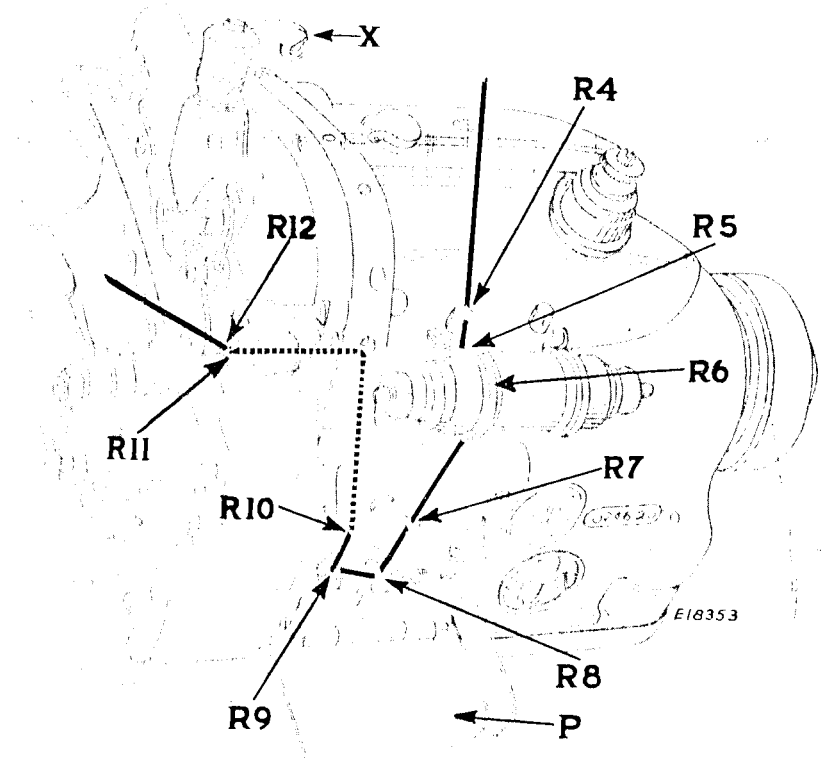

Fig. 8. Threading Right Looper

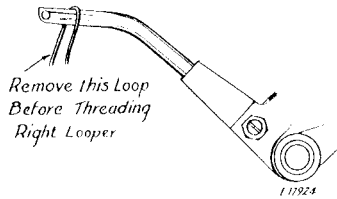

Fig. 9. Right Looper

and from right to left through the eyelet R8, then from right to left through eye R9 in the right take-up.

Using the threading wire, shown in Fig. 7, page 7, guide the thread into the tube opening R10. Draw the threading wire out of the tube exit R11, Fig. 8. Then pass the thread from front to back through the eye R12 of the right looper.

Draw about two inches of thread through the eye of the right looper, with which to commence sewing.

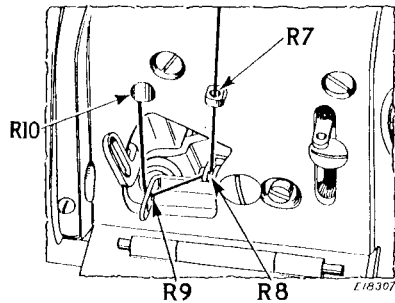

Fig. 10. Threading Right Looper Take-up

TO THREAD THE LEFT LOOPER

See Figs. 11 and 12

Lead the thread from eyelet L3, Fig. 5, page 5, on the unwinder and pass it from back to front through the thread guide L4, Fig. 11, then under the guide L5 and over between the tension discs L6. Pull the cover plate P forward and pass the thread down through the eyelet L7, Fig. 12 and from right to left through the eye L8 in the right take-up, then from right to left through the slot L9 in the left take-up.

Using the threading wire, shown in Fig. 7, page 7, guide the thread from right to left through the tube L10, then up the groove L11, Fig. 11.

Turn the balance wheel over from you enough to place the eye L13 of the left looper directly in line with the tube L12. Then pass the thread from

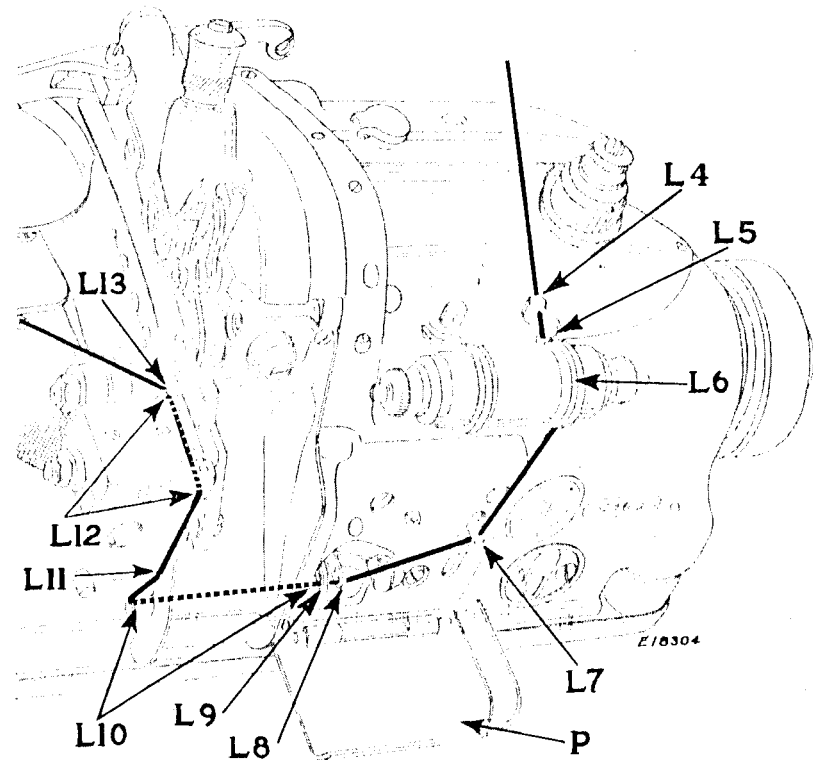

Fig. 11. Threading Left Looper

front to back, through the tube L12 and through the eye L13 of the left looper.

Draw about two inches of thread through the eye of the left looper, with which to commence sewing.

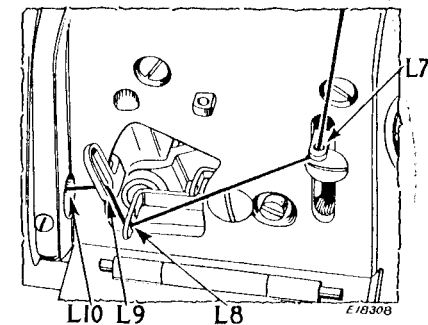

Fig. 12. Threading Left Looper Take-up

TO REGULATE THE TENSIONS

See Fig. 13

Tensions of the needle thread and the looper threads should be sufficient to ensure the proper stitch, permitting the threads to be easily drawn without breaking.

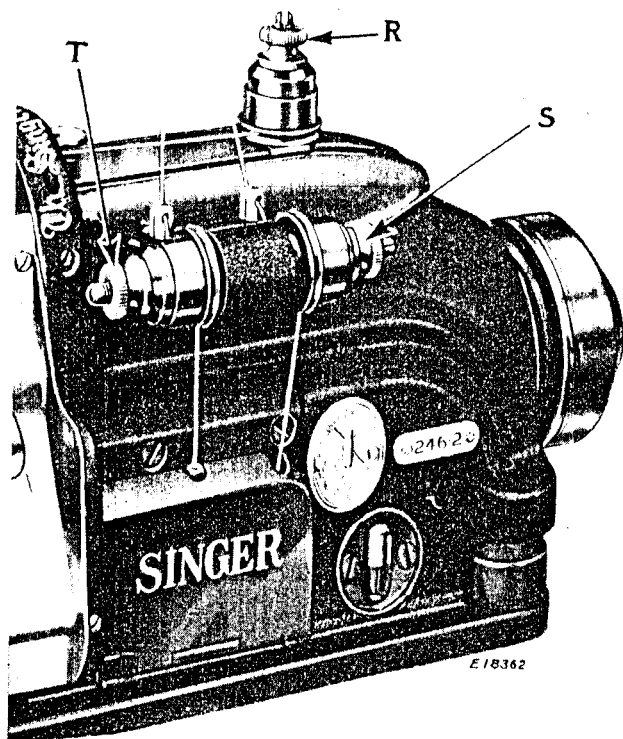

Fig. 13. Adjustments for Tension

The tension of the needle thread is regulated by the thumb nut R. The tension of the left looper thread is regulated by the thumb nut S. The tension of the right looper thread is regulated by the thumb nut T.

TO REGULATE THE PRESSURE ON THE MATERIAL

See Fig. 14

The pressure of the presser foot V on the material, is regulated by the thumb screw U at the top of the machine. To increase the pressure, turn the thumb screw U downward. To decrease the pressure, turn the thumb screw U upward.

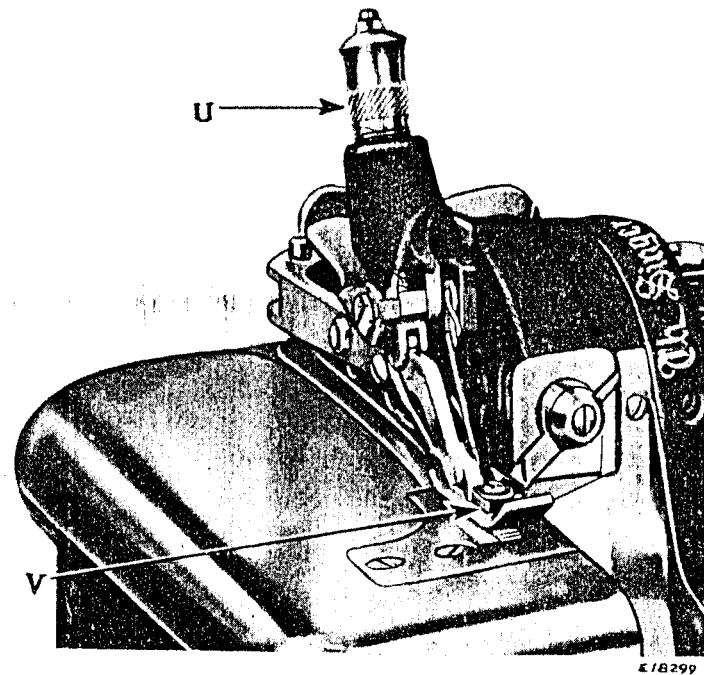

Fig. 14. Adjustment of Pressure on Material

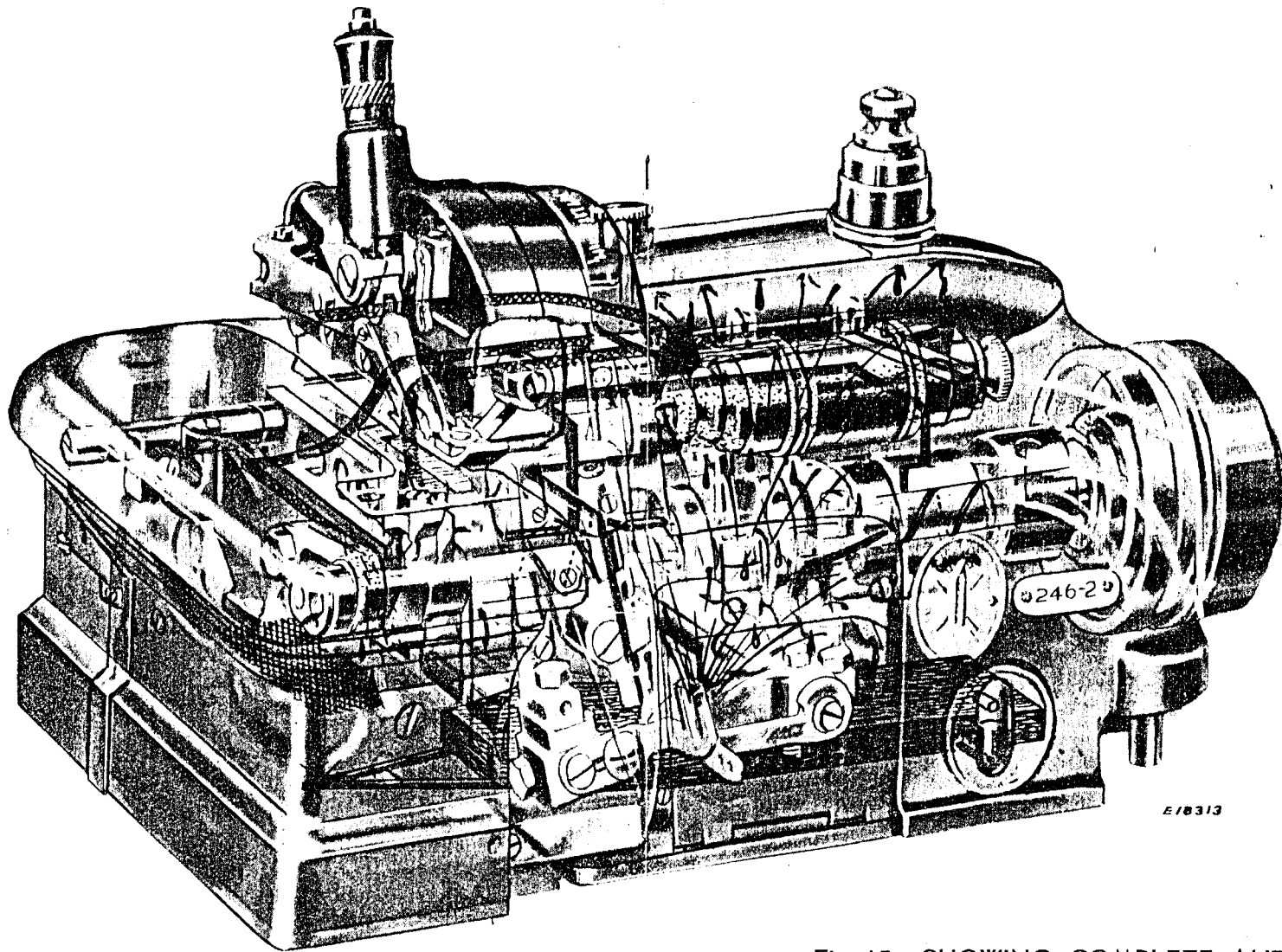

Fig. 15. SHOWING COMPLETE AUTOMATIC LUBRICATION SYSTEM OF MACHINE 246-2

TO CHANGE THE LENGTH OF STITCH

Figs. 16 and 17

The length of stitch is determined by the feed which consists of one feed dog actuated by one feed eccentric C2.

The feed eccentric is marked with the number of stitches it makes, as shown at F2.

Feed eccentric #164020 can be furnished to make 4, 5, 6, 7, 8, 9, 10, 11, 12, 13, 14, 16 or 18 stitches per inch. Unless otherwise ordered, only one feed eccentric making approximately 4 stitches per inch, is regularly supplied with the machine.

To remove the feed eccentric, swing the cloth plate Q and the feed eccentric cover S5 out to the left, remove the hex nut and spacing collar K4 from the shaft D2 and screw the feed eccentric extractor T5, supplied with the machine, into the threaded hole E2.

By pulling gently with the extractor T5, the feed eccentric can be removed.

When replacing the feed eccentric, be sure that the stamped number, F2 is on the outside face of the eccentric. The groove G2 should fit over the key H2 on the shaft D2. When feed eccentric is firmly in position, replace the spacing collar K4 and screw the hex nut securely on the shaft D2.

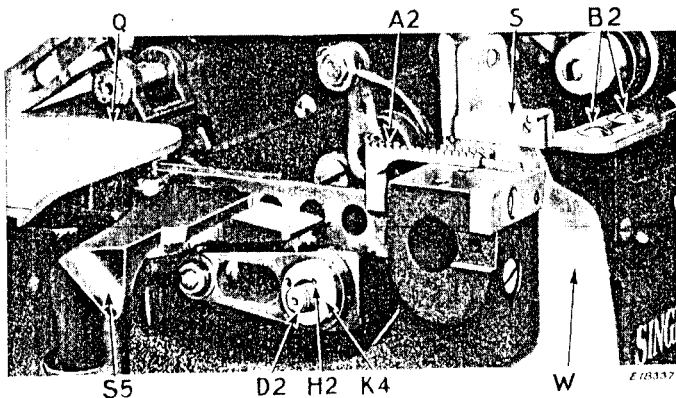

Fig. 17. Adjustments of Feed

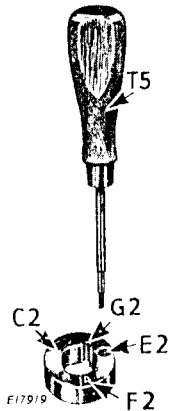

Fig. 16. Feed Eccentric and Extractor

TO SET THE FEED DOG AT THE CORRECT HEIGHT

See Fig. 18

To check the height of the feed dog, swing the presser bar K out to the left, and turn the balance wheel over from you until the feed dog is at its highest position. Place the gauge J2, furnished with the machine, over the feed dog and firmly resting upon the throat plate, as shown in Fig. 18. At this setting, the feed dog A2 should just touch the bottom face K2 of the gauge.

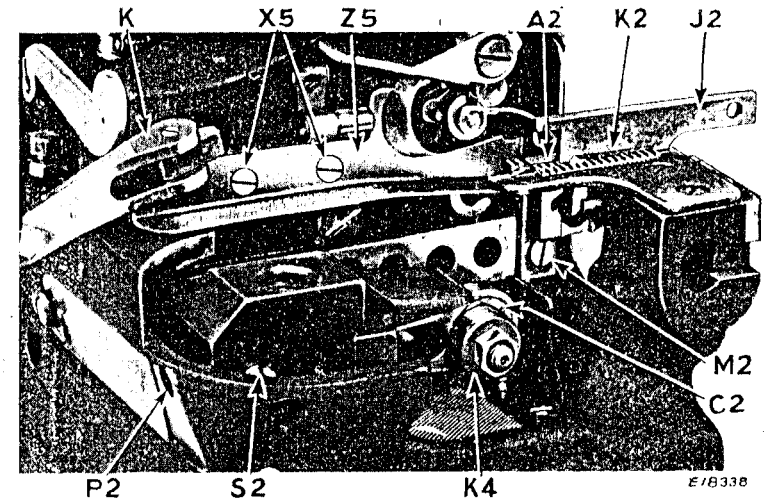

Fig. 18. Setting the Feed Dog

To set the feed dog A2, swing the cloth plate Q, Fig. 17 and the feed eccentric cover S5, Fig. 17 out to the left, then loosen the adjusting screw M2 and move the feed dog A2 up or down, as required. Then tighten the screw M2.

TO TILT THE FEED DOG

See Fig. 18

When it is desired to tilt the feed dog, first set it at the correct height as described above. Then loosen the hinge pin set screw P2 at the rear of the machine.

To tilt feed up in the rear and down in the front of the needle, slowly turn the hinge pin S2 over toward the rear of the machine, until the desired amount of tilt is obtained.

To tilt the feed down in the rear and up in the front of the needle, slowly turn the hinge pin over toward the front of the machine, until the desired amount of tilt is obtained. Then tighten the screw P2.

TO SET THE NEEDLE CARRIER AT THE CORRECT HEIGHT

See Figs. 19 and 20

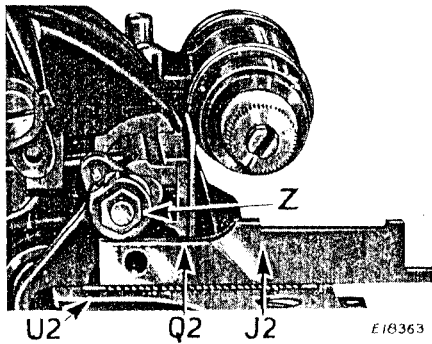

Fig. 19. Checking the Needle Carrier Height

At this setting, the needle carrier Z should just touch the top surface Q2 of the gauge J2.

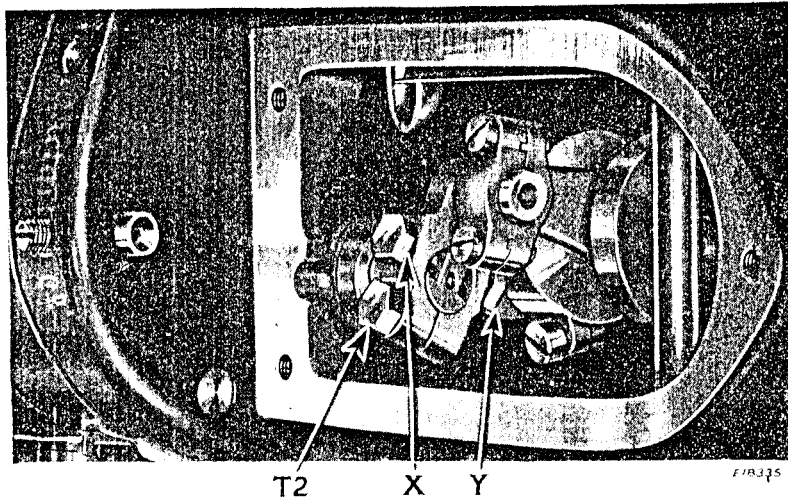

Fig. 20. Adjusting the Needle Carrier Height

To set the needle carrier at the correct height, remove the top frame cover and loosen the clamping screw T2 and the two adjusting screws X and Y. Move the needle carrier Z up or down, as required. Then first securely tighten the screw T2. Next tighten the two screws X and Y, and replace the top frame cover on the machine.

TO SET THE LEFT LOOPER IN RELATION TO THE NEEDLE

See Figs. 21 and 22

To install the left looper, remove the throat plate U2, Fig. 19 and the chip guard W, Fig. 17, page 14. Loosen the set screw W2 in the left looper holder C3, and set the looper all the way down into the holder. Then securely tighten the set screw W2.

To set the left looper the proper distance left of the needle remove the throat plate U2, Fig. 19 and the chip guard W, Fig. 17. Turn the balance wheel over from you, until the needle, after reaching its lowest point, rises 1/64 inch. At this setting, the tip of the looper Z2 should just touch the left side of the needle. When it does not reach the needle at this setting, loosen the right adjusting screw B3, and then tighten the left adjusting screw A3, until the tip of the left looper Z2 reaches the proper position. Then securely tighten screw B3 and recheck the side-wise position of the left looper in relation to the needle as described above.

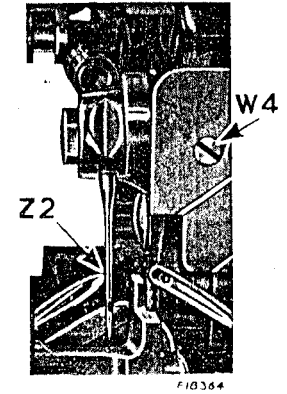

Fig. 21. Setting the Left Looper

When the left looper passes the needle at this setting, loosen the left adjusting screw A3 and tighten the right adjusting screw B3, until the tip of the left looper Z2 returns to the proper position. Then righten the screw A3 and recheck the sidewise position of the left looper in relation to the needle as described above.

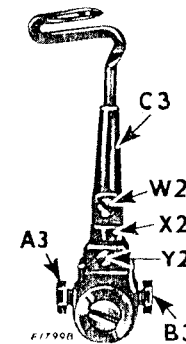

Fig. 22
Left Looper

The left looper must rub lightly on the needle, as it passes behind the needle in its movement toward the right. To set the left looper correctly behind the needle, remove the throat plate U2, Fig. 19 and the chip guard W, Fig. 17 and turn the balance wheel over from you, until the point of the left looper just passes the needle. Loosen the adjusting screw Y2 and the set screw X2 and move the looper holder C3 until the left looper Z2 almost touches the needle, from the rear. Tighten the set screw X2 and then slowly tighten the adjusting screw Y2 until the left looper Z2 actually rubs on the needle. Then replace the throat plate U2, Fig. 19, and the chip guard W, Fig. 17.

TO SET THE RIGHT LOOPER IN RELATION TO THE NEEDLE

See Figs. 23 and 24

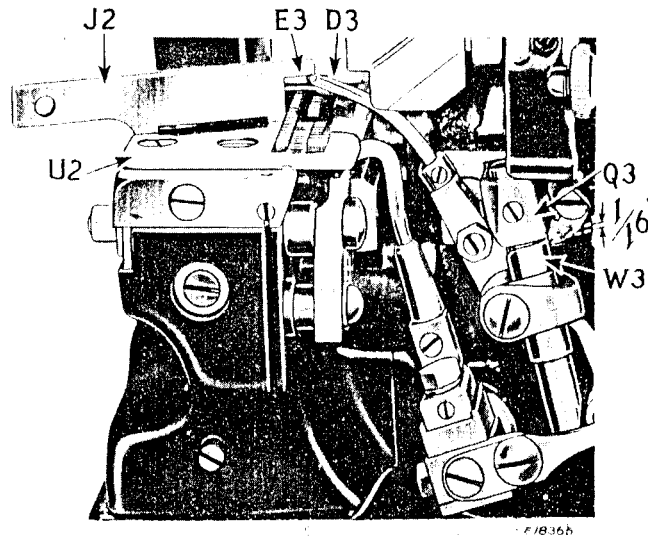

Fig. 23. Setting the Height of the Right Looper

To properly adjust the right looper setting, swing the presser foot out to the left, remove the chip guard W, Fig. 17, page 14, open the front cover plate P, Fig. 25, page 20, and remove the looper thread plate O3, Fig. 25.

Adjust the right looper in the same order given in the following instructions.

1. When the right looper carrier is at its extreme left motion, the distance between the bracket Q3 and the guide bar W3 should be approximately 1/16 inch, as shown in Fig. 23.

To adjust the distance between the bracket and guide bar, loosen the clamping screw M3 and the adjusting screws N3 and P3. To increase this distance, tighten the lower adjusting screw P3 until the proper distance is obtained, then tighten the opposite adjusting screw N3. To decrease this distance, tighten the upper adjusting screw N3 until the proper distance is obtained, then tighten the opposite adjusting screw P3. When the proper setting is obtained, securely tighten the clamping screw M3.

2. Loosen the two set screws G3 and move the bracket Q3 right and left to determine its extreme right and left positions on the casting. Locate the bracket Q3 at the midpoint of the two extremes and tighten the two set screws G3.

3. Insert the looper D3 in the looper carrier S3 and place the gauge J2 on the throat plate U2, as shown in Fig. 23. When the right looper D3 is at its extreme left motion, it should touch the undersurface E3 of the gauge J2.

To set the right looper at the correct height loosen the set screw F3 on the looper collar K3 and loosen the nut on the locking screw stud H3 on the looper carrier S3. Making sure that the slot in the locking screw stud H3 is in line with the looper carrier, set the right looper D3 up or down in looper carrier, as required, and tighten the nut on the stud H3 in looper carrier. Then press looper collar K3 firmly down against the looper carrier and securely tighten the set screw F3.

4. When the right looper passes the left looper, it should pass behind the left looper head, and just to the left of the left looper eye. To adjust the right looper to the right or left, loosen the set screws G3 in the looper carrier guide block bracket and move the bracket Q3 to the right or left, as required, then securely tighten the two set screws G3. Recheck and adjust the height of the right looper as described above.

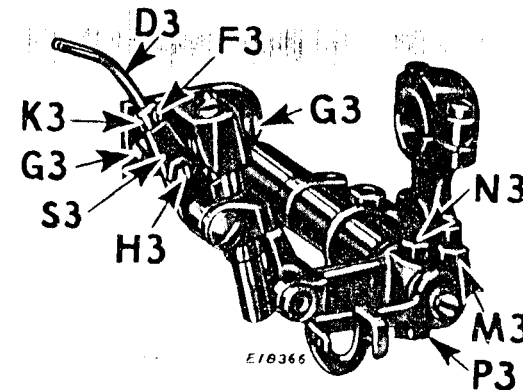

Fig. 24. Adjustments of the Right Looper

5. The right looper, when passing behind the left looper, should brush lightly on the front of the needle. To adjust this position of the right looper D3, loosen the nut on the stud H3 and move the right looper D3 in the right looper carrier S3, as required, then securely tighten the nut on the stud H3. Recheck and adjust the height and the right and left position of the right looper, as described above.

When all the settings of the right looper have been properly adjusted, check each setting again and make sure all set screws and nuts are securely tightened. Then replace looper thread plate O3, Fig. 25, and chip guard W, Fig. 17.

TO SET THE LOOPER TAKE-UP (LEFT)

See Fig. 25

When left looper **Z2** is moved to its extreme right position, the center of the slot in the left take-up **X3** should be in line with the center of the left looper thread bushing **Y3**, as shown in Fig. 25.

To set the left take-up **X3**, remove the chip guard **W**, Fig. 17, and open the front cover plate **P**. Loosen the two set screws **T3** and raise or lower the right end of the left take-up **X3**, as required. Then securely tighten the set screws **T3** and replace the chip guard **W**.

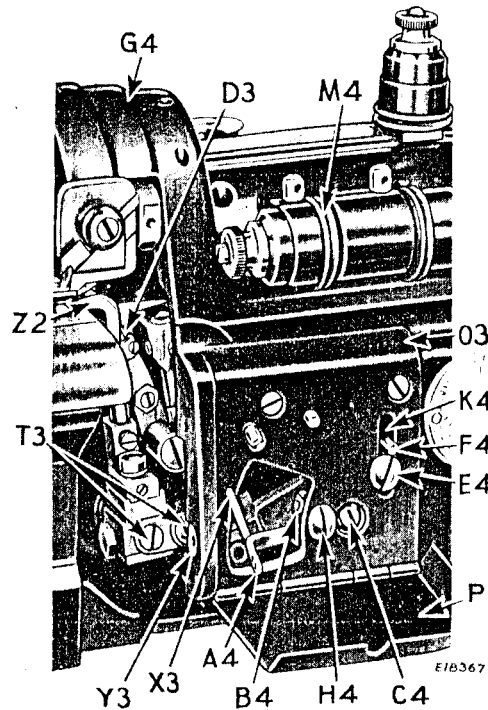

Fig. 25. Adjustments of the Looper Thread Take-up

TO SET THE LOOPER TAKE-UP (RIGHT)

See Fig. 25

When left looper **Z2** is moved to its extreme right position, the eye on the right take-up **A4** should be in line with the left looper thread bushing **Y3** and the center of the slot in the left take-up **X3**, as shown in Fig. 25.

To set the right take-up **A4**, open the front cover plate **P** and loosen the set screw **C4**. Raise or lower the right take-up **A4**, as required. Then securely tighten the set screw **C4** and close the cover plate **P**.

TO SET THE RIGHT LOOPER THREAD EYELET

See Fig. 25

The right looper thread eyelet **B4** should be normally at the midpoint of the top and bottom extremes of its adjustment, as shown in Fig. 25.

To set the right looper thread eyelet, open the front cover plate **P** and loosen the set screw **H4**. Raise or lower the eyelet **B4**, as required. Then securely tighten the set screw **H4** and close the cover plate **P**.

TO SET THE LEFT LOOPER THREAD EYELET

See Fig. 25

The left looper thread eyelet **F4** should be normally at the midpoint of the slot **K4**, as shown in Fig. 25.

To adjust the left looper thread eyelet, loosen the set screw **E4** and raise or lower the eyelet **F4** to the proper location. Then securely tighten the set screw **E4**.

TO ADJUST THE TAKE-UP FOR BOTH LOOPER THREADS

See Fig. 25

To get more thread through both loopers, lower the right take-up **A4**, or raise the left take-up **X3**.

To get less thread through both loopers, raise the right take-up **A4**, or lower the left take-up **X3**.

TO ADJUST THE SLACK ON THE RIGHT LOOPER THREAD

See Fig. 25

When the right looper **D3** is moved to its extreme left position, the right looper thread between the eyelet **B4** and the tension discs **M4** should have a slight slack. To decrease the slack on right looper thread, lower eyelet **B4**. To increase the slack on right looper thread, raise eyelet **B4**.

TO ADJUST THE STATIONARY KNIFE IN RELATION TO THE CHAINING-OFF FINGER

See Fig. 26

To adjust the stationary knife **J4**, in relation to the chaining-off finger on the throat plate, loosen the set screw **T4** and move the stationary knife holder **S4** to the left or right, as required. Then securely tighten the set screw **T4**.

TO ADJUST THE MOVABLE KNIFE IN RELATION TO THE STATIONARY KNIFE

See Fig. 26

To adjust the movable knife D4, in relation to the stationary knife J4, remove the clamp screw Q4, the knife clamp Z3, and the chip ejector O4. Loosen the set screw W4, Fig. 21, page 17, and move the knife holder P4 to the right or left, until the cutting edge of the movable knife D4, at its lowest position, is slightly below the cutting edge of the stationary knife J4. Securely tighten the set screw W4, Fig. 21. Then replace the chip ejector O4, the knife clamp Z3 and the clamp screw Q4. While pressing the movable knife D4 downward against the stationary knife J4, tighten the screw Q4.

TO REMOVE THE STATIONARY KNIFE

See Fig. 26

To remove the stationary knife J4, loosen the nut V4, and draw the knife J4 upward and out.

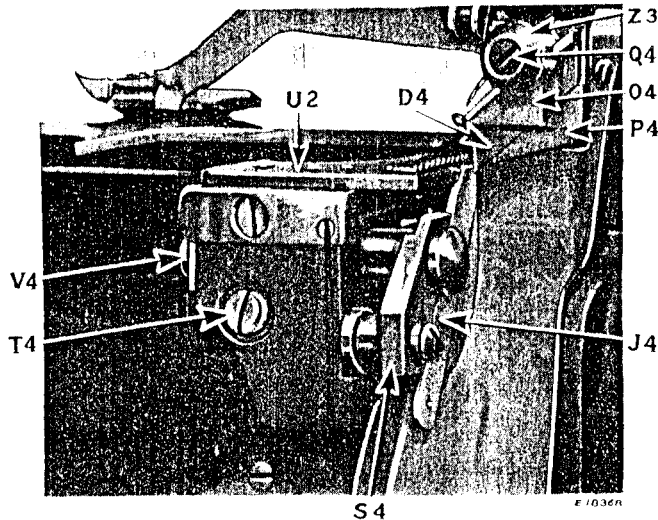

Fig. 26. Adjusting the Trimmer

TO REPLACE THE STATIONARY KNIFE

See Fig. 26

To replace the stationary knife J4, push the knife downward in the knife holder S4, until the cutting edge of the knife is flush with the throat plate U2. Then securely tighten the nut V4.

TO REMOVE THE MOVABLE KNIFE

See Fig. 26

To remove the movable knife D4, remove the clamp screw Q4, the knife clamp Z3 and the chip ejector O4. Then lift the knife D4 from the knife holder P4.

TO REPLACE THE MOVABLE KNIFE

See Figs. 26 and 27

To replace the movable knife D4, slip the knife in knife holder P4, replace the chip ejector O4, the knife clamp Z3 and the clamp screw Q4. Press the movable knife D4 downward against the stationary knife J4 and securely tighten the clamp screw Q4.

Then turn balance wheel over from you, until the lowest point X4, of the cutting edge of the movable knife D4, just reaches the cutting edge of the stationary knife J4, as shown in Fig. 27. Loosen the set screw T4 sufficiently to release the spring behind the stationary knife J4, permitting the stationary knife to make a tight spring contact with the movable knife D4. Then securely tighten the set screw T4.

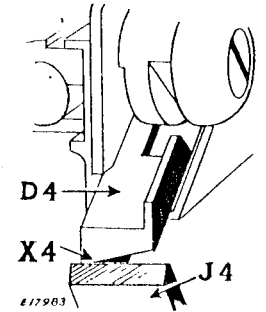

Fig. 27
Contact Point of Knives

TO SHARPEN THE TRIMMER KNIVES

See Figs. 28 and 29

Knife Grinder #151056, illustrated here, is essential for sharpening the knives used on the 246 Class Machine. The use of this grinder insures the correct bevel of the cutting edge of each knife. Do not attempt to sharpen these knives by hand.

The Knife Grinder should always be operated within the voltage range stamped on the motor name-plate.

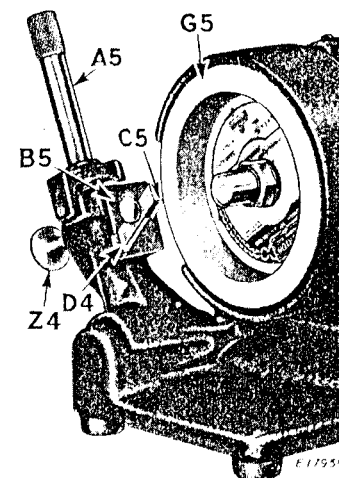

Fig. 28. Sharpening the Movable Knife

To sharpen movable knife D4, insert it in the knife holder B5, on the front of the lever arm A5, then tighten the thumb screw Z4.

Turn on the motor at the switch H5, Fig. 29. Then turn the thumb nut E5, Fig. 29, over from you until the knife D4 clears the grinding face G5. While moving the lever arm A5 alternately back and forth, turn the thumb nut E5 as required, to bring the cutting edge of the knife lightly against the grinding face of the wheel.

Continue the back and forth motion of the lever arm, grinding off only enough to sharpen the cutting edge.

The movable knife is thus ground to a shearing edge, requiring no special setting in the machine to shear.

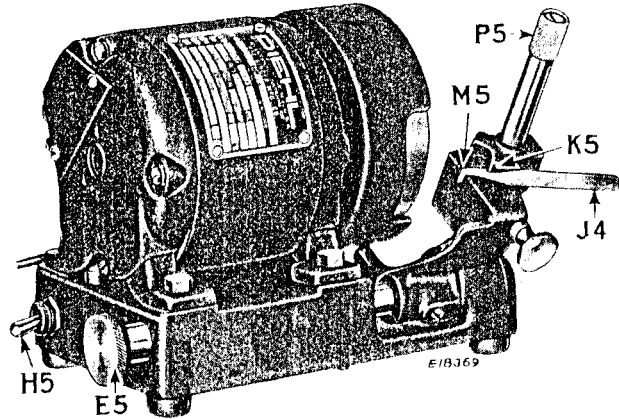

Fig. 29. Sharpening the Stationary Knife

To sharpen the stationary knife J4, insert it in the knife holder K5, on the rear of the lever arm, so that its bevel M5 is parallel with the grinding face G5 of the grinding wheel, then by turning the knurled end P5, of the lever arm, screw the lever arm into the knife holder K5, securing the knife. Sharpen the knife as described on page 23.

Genuine "SINGER" Needles should be used in "SINGER" Machines.
These Needles and their Containers are marked with the Company's Trade Mark "SIMANCO." 1

Needles in Containers marked "FOR SINGER MACHINES" are NOT "SINGER" made needles. 2