

# **SINGER**

**248-2**

# USE ONLY **SINGER\*** OILS and LUBRICANTS

*They insure freedom from lubricating trouble and  
give longer life to this machine.*

*The following are the correct lubricants for this machine:*

**TYPE B**—MANUFACTURING MACHINE OIL, HEAVY GRADE

*When a stainless oil is desired, use:*

**TYPE D**—MANUFACTURING MACHINE OIL, STAINLESS,  
HEAVY GRADE

NOTE: The above oils are available in 1 quart, 1 gallon  
and 5 gallon cans or in 55 gallon drums.

## THE IMPORTANCE OF USING **SINGER\*** PARTS IN **SINGER** MACHINES

The successful operation of **SINGER** machines can only be  
assured if **SINGER** parts are used. Supplies are available  
at all **SINGER** Shops for the Manufacturing Trade and mail  
orders will receive prompt attention.

## TO ALL WHOM IT MAY CONCERN:

The improper placing or renewal of the Trade Mark  
"SINGER" or any other of the Trade-Marks of The Singer  
Manufacturing Company (all of which are duly Registered  
Trade Marks) on any machine that has been repaired,  
rebuilt, reconditioned or altered in any way whatsoever  
outside a **SINGER** factory or an authorized **SINGER** agency  
is forbidden.

Copyright, U. S. A., 1946, 1947 and 1950  
by The Singer Manufacturing Company  
All Rights Reserved for all Countries

20098

INSTRUCTIONS

FOR USING AND ADJUSTING

# **SINGER\***

## ELECTRONIC SEAMER

# 248-2

(INCLUDING TECHNICAL SUMMARY OF TYPE G26 OSCILLATOR)

FOR BONDING THERMOPLASTIC MATERIALS

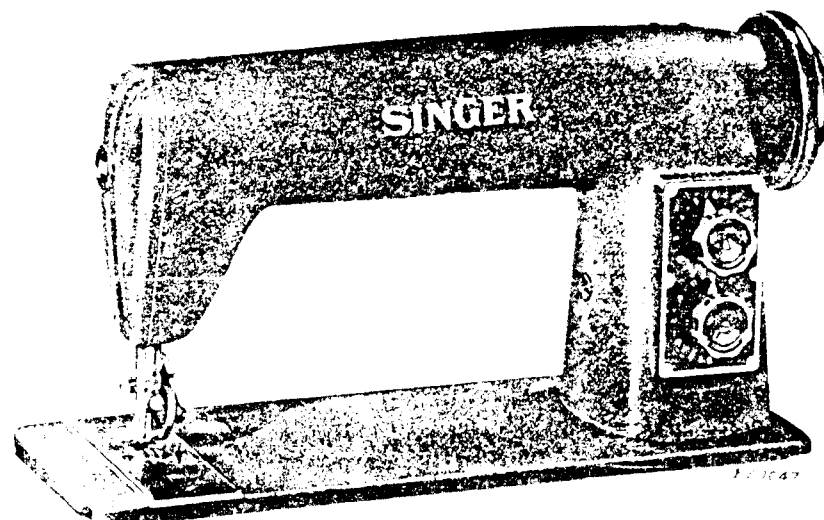

MACHINE 248-2

\*A Trade Mark of

## THE SINGER MANUFACTURING CO.

## DESCRIPTION

**Machine 248-2** is especially designed for bonding thermoplastic materials which are adapted for this method of bonding.

This machine is arranged for 115 volt, 50-60 cycle alternating current. In case this equipment is to be used where current of these characteristics is not available, the matter should be referred to Executive Office.

The top rotary shaft of this machine drives the upper reciprocating electrode (the bonding foot). This bonding foot, in conjunction with the lower, stationary electrode, produces the seam as the result of the high frequency current passing between these electrodes and through the material being bonded.

**Dual speed control.** The dual speed is regulated by two knobs conveniently located on the front side of the machine. The upper knob regulates the extent of feeding action of the under feed disc, and the lower knob, in conjunction with a foot treadle, provides the means for instantly reducing the speed, or extent of feeding action, when encountering added thickness of material during the bonding operation.

The machine is furnished with both a left and right hand roller presser, and unless otherwise ordered, the machine will be equipped with the right hand roller presser.

A micromatic adjustment regulates the lift of the upper reciprocating electrode (the bonding foot).

Automatic lubrication is provided for the feed clutch.

A tuning unit is located at the under side of the machine bed. This tuning unit is operated by means of a knob conveniently located at the under side of the machine bed, and is connected with a dial indicator on top of the machine bed in direct view of the operator. The manipulation of this tuning unit accurately regulates the electric current for the bonding operation.

A foot lifter is regularly furnished for the roller presser. A knee lifter will be furnished in place of the foot lifter, when so ordered.

Balance wheel for  $\frac{3}{8}$  inch V-belt.

The oscillator has a coaxial tuning unit cable and is equipped with conveniently located switches and a control knob, and with a switch for simultaneously starting the oscillator and the machine-driving electric transmitter.

Four spare tubes, at no extra charge, are supplied with the oscillator.

Space at right of electrode is 11 inches.

## SPEED

The speed of the Electronic Seamer 248-2 is 2450 R. P. M., using Pulley No. 169077 (4" outside diameter) or 3100 R. P. M., using Pulley No. 876713 (5" outside diameter), when equipped with Electric Transmitter having a speed of 1725 R. P. M.

The following approximate speeds in feet per minute are obtained with the indicator on the upper feed-regulating knob **G2, Fig. 9** set at the numbers listed below:

Upper Feed Regulating Knob Settings	5" Pulley Average Speed in Feet per Minute	4" Pulley Average Speed in Feet per Minute
11	5-1/2	3
10-1/2	8	4
10	10	5
9-1/2	12	6
9	14	7
8-1/2	16	8
8	18	9
7-1/2	20	10
7	22	11
6-1/2	24	12
6	25	13
5-1/2	27	14
5	29	15
4-1/2	30	16
4	32	17
3-1/2	34	18
3	36	19
2-1/2	37	20
2	39	21
1-1/2	41	22
1	43	23
1/2	44	24
0	45	25

## TO SET UP THE EQUIPMENT

(See Figs. 2 and 3)

Place the machine in the cut-out for same in the table, having the two hinge studs at R in the holes provided for same in the rear side of the machine bed, so that the machine may be laid back on the rest pin F for convenient access to the under side of the machine bed.

Fig. 2 shows the complete unit with the oscillator E in proper position on the floor at the right of the stand, where the control knob and switches can be conveniently reached by the operator.

Fig. 3 shows a rear view of this equipment, but with the oscillator moved from its operating position to more clearly show the four electrical connections which are as follows:

(H) The cord from the transmitter A to the Singerlight G.

(P) The cable from the oscillator E to the outlet from which the electric current is obtained.

(K) The cable from the transmitter capacitor box Q, which cable is plugged into the oscillator at L.

(J) The cable from the micro-switch S, which cable is plugged into the oscillator at M. It is controlled by the treadle B which, when depressed, starts the electric transmitter which drives the feed mechanism of the Electronic Seamer and, at the same time, permits the high frequency current from the oscillator to pass to the electrodes of the Electronic Seamer only when the machine is running. To apply current to the electrodes while the machine is not running, use switch T on the front of the oscillator.

(N) The coaxial cable, one end of which is plugged into the oscillator at O, the other end being plugged into the tuning unit housing at the under side of the machine bed.

Treadle C lifts the roller presser and the bonding foot for the purpose of inserting material, etc.

Treadle D the compensating feed treadle slows the feeding speed to accommodate any extra thicknesses of material being bonded.

The pitman for treadle B is adjustable for length.

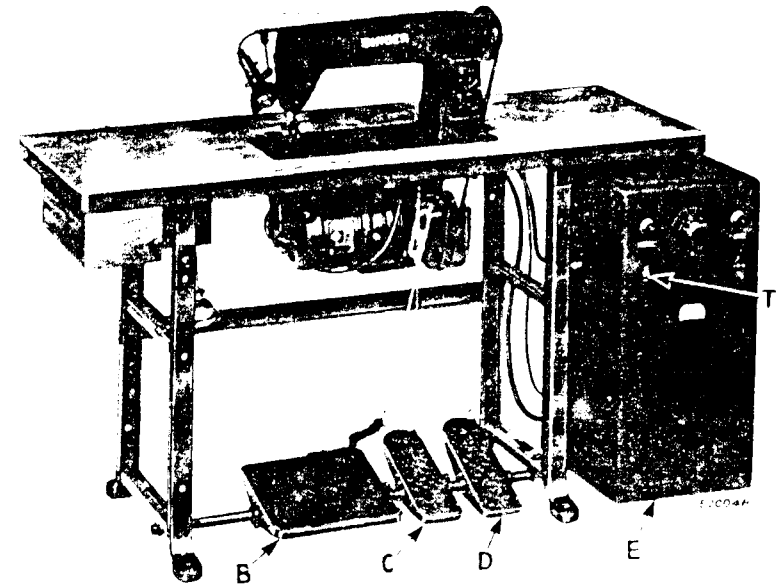

Fig. 2. Front View of SINGER Electronic Seamer on Table 129785 and Stand 46980, with Electric Transmitter and Oscillator

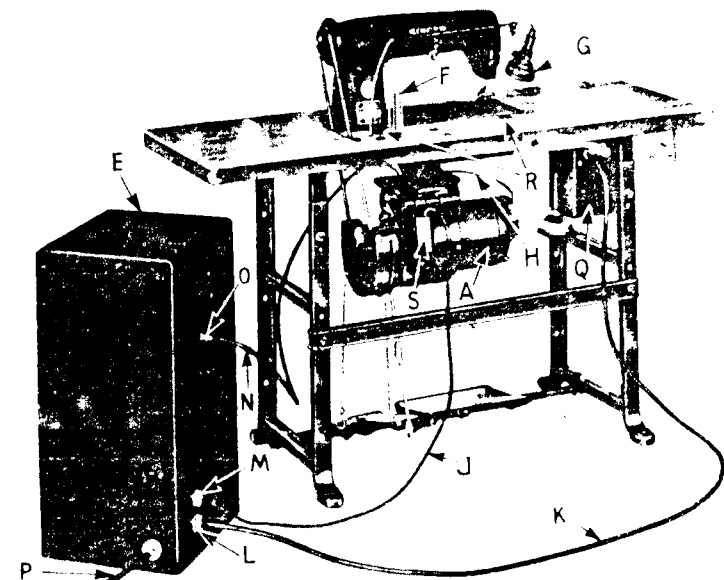

Fig. 3. Rear View of SINGER Electronic Seamer on Table 129785 and Stand 46980, with Electric Transmitter and Oscillator

## TO OIL THE MACHINE

Before starting the machine, disconnect the compensating feed chain from the foot treadle **D**, Fig. 2, page 5.

Use "TYPE B" or "TYPE D" OIL, sold only by Singer Sewing Machine Company. See inside front cover for description of these oils.

Lay the machine back on the rest pin and fill the feed clutch oil reservoir **U**, Fig. 4 which is attached to the under side of the table—to approximately  $\frac{1}{8}$  inch from the top, then tilt the machine forward to its operating position and reconnect the feed treadle chain to the feed treadle.

Apply a few drops of oil twice daily to the oiling places indicated by arrows in Fig. 5. The oiling places are painted with vermilion lacquer.

**CAUTION**—The oil hole **V**, Fig. 5 is for the bonding foot bar. Too much lubrication at this point will result in the oil collecting on the bonding foot, the lower electrode and the insulating block to which the lower electrode is fastened. Keep these parts wiped clean at all times. When the machine is standing idle for some time as, for instance, over night, place a waste piece of the bonding material between the bonding foot and the lower electrode to prevent the oil from seeping down upon the lower electrode, insulating block, etc.

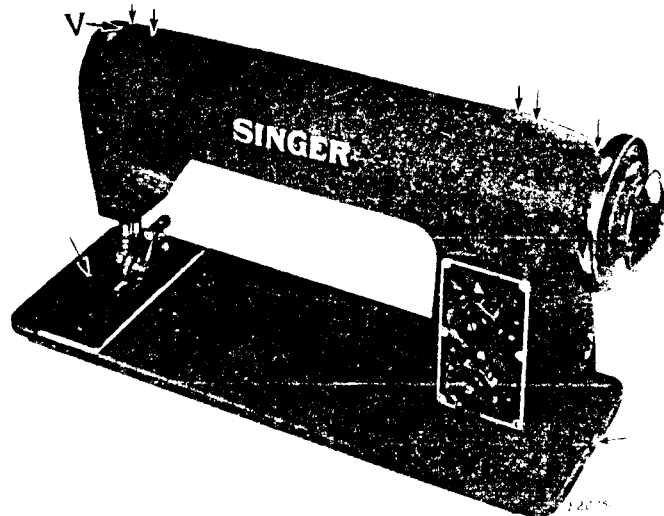

Fig. 5. Oiling Points in Arm and Machine Bed

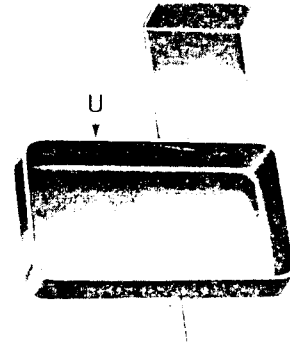

Fig. 4  
Feed Clutch Oil Reservoir

## TO LUBRICATE THE ELECTRIC TRANSMITTER

The electric transmitter, Fig. 6, which drives the feeding mechanism of the Electronic Seamer, is shown in Figs. 2 and 3, page 5, attached to the under side of the table upon which the Electronic Seamer is mounted.

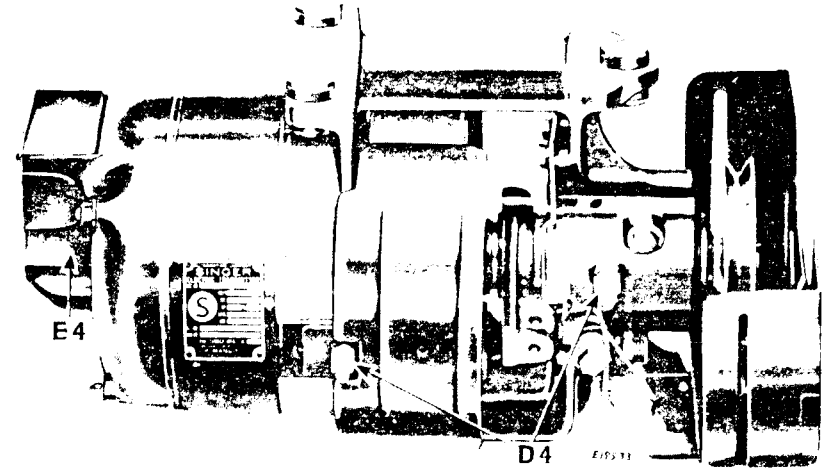

Fig. 6. Lubrication Points on Electric Transmitter

When the equipment leaves the factory, the ball bearings of the transmitter are packed with sufficient lubricant for six months of operation. At least every six months thereafter, these ball bearings must be lubricated with **BALL BEARING LUBRICANT**, sold only by Singer Sewing Machine Company, through the Alemite fittings **D4**. For this purpose use Grease Gun 121587 (3 oz. capacity) or Grease Gun 121588 (1 lb. capacity). Five strokes with either gun at each of these two fittings is sufficient.

These grease guns are supplied, on order, at extra charge.

The waste-packed oil reservoir **E4** should be replenished about every three months with **MOTOR OIL**, sold only by Singer Sewing Machine Company.

The bearings should receive just enough lubricant to fill the bearing housings, and no more. Excess lubricant is forced out of the housings and, coming in contact with the motor windings, causes short circuits and burned-out motors.

## TO OPERATE THE MACHINE

With all connections made as instructed under "To Set up the Equipment," page 4, turn the powerstat knob **W**, Fig. 7, on the front of the oscillator, to between 52 and 55 on the series of numbers surrounding this knob. Then turn on the power switch **X**, Fig. 7. The "on" position is indicated by a yellow light immediately above the switch **X**. This switch provides the current for the transmitter motor **A** which drives the Electronic Seamer.

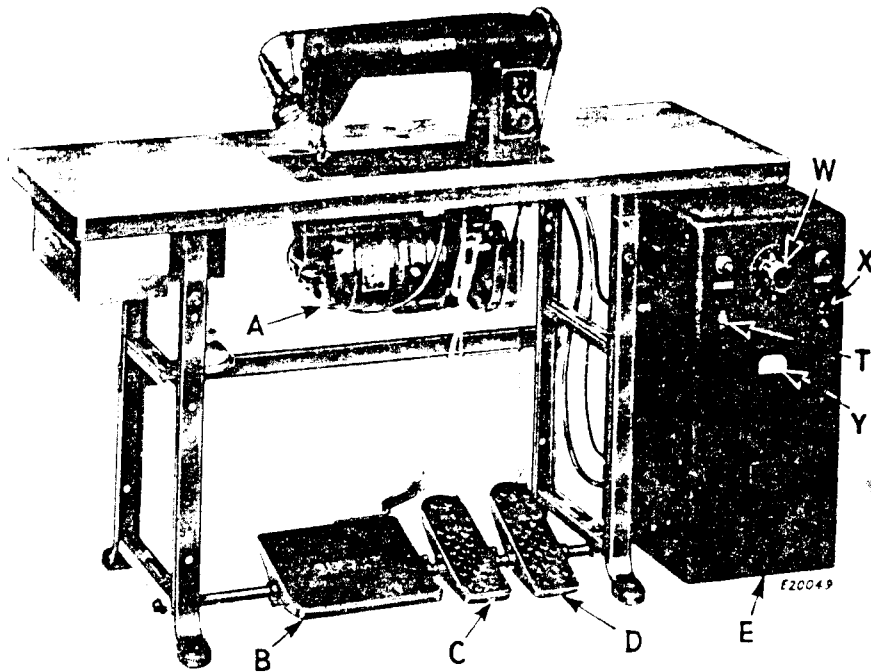

Fig. 7. Front View of Oscillator, Transmitter and Control Treadles

**NOTE**—With the switch **T** "on," the high frequency current is constantly at the electrodes **D2** and **F2**, Fig. 8 even while the machine is not actually running. Therefore, provision is made, by means of treadle **B**, Fig. 7, to apply the high frequency current to the electrodes only as required for the bonding operation while the switch **T** is in "off" position.

See "To Adjust Micro-Switch" page 24.

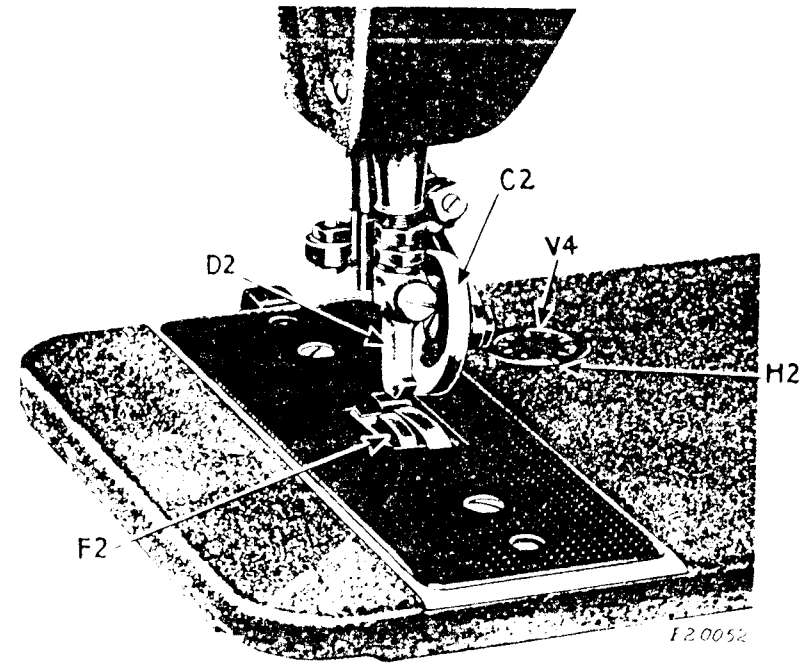

Fig. 8. Roller Presser, Bonding Foot, Lower Electrode and Tuning Dial

Set the upper feed-regulating knob **G2**, Fig. 9, at the front side of the machine, at a low speed with which to start, say at about 10 or 10½ on the series of numbers surrounding this knob. The maximum speed is obtained with the pointer on the knob at "O." Lower speeds are obtained by turning this knob clockwise. See speed chart on page 3.

For the first attempts at bonding, use waste pieces of the material being bonded, in as many thicknesses as will be used in the final bonding operation.

Place the material beneath the bonding foot **D2**, Fig. 8, page 9 and the roller presser. Release the treadle **C**, Fig. 7, page 8, or let down the hand lifting-lever at the rear side of the machine head, to lower the bonding foot upon the material. Depress the treadle **B**, Fig. 7 to engage the transmitter clutch which drives the feed mechanism of the Electronic Seamer and, at the same time, operates the micro-switch at the rear side of the transmitter to apply the high frequency current to the electrodes.

**CAUTION**—The machine should always be operated at full speed, i. e., the clutch should not be "slipped" as is common practice when lower speeds are required in the operation of sewing machines.

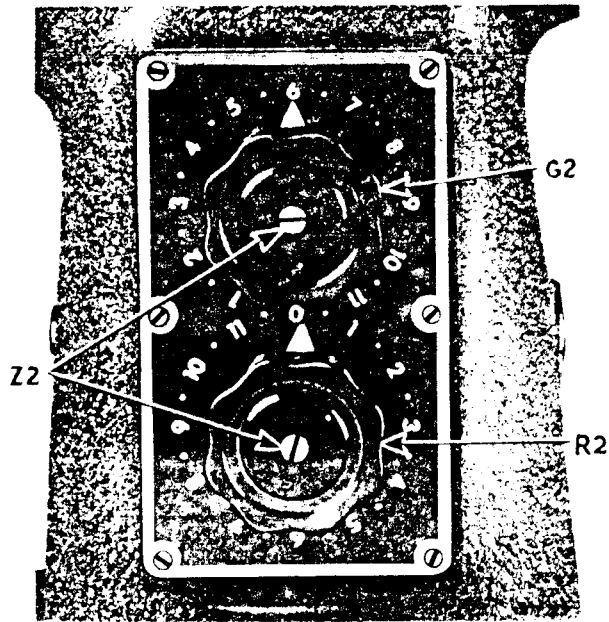

Fig. 9. Speed Regulating Knobs

While the material is being fed through, observe the result of the bonding. If there is no seam, or bond, or if the seam appears indefinite, turn the tuning knob **J2**, Fig. 10 until a distinct seam appears and the highest reading is obtained on the millimeter **Y**, Fig. 7. This tuning knob is conveniently reached beneath the table.

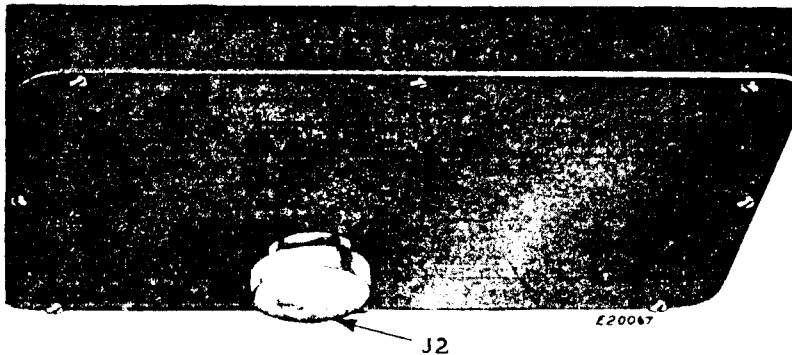

Fig. 10. Tuning Knob at Under Side of Machine

To determine definitely whether or not the plies of material are satisfactorily bonded, remove the material from the machine and test the seam by pulling the material away from the seam. If the material tears at the seam, while the seam remains intact, the bonding may be considered satisfactory. However, if a complete revolution of the tuning knob **J2** fails to produce a satisfactory seam, the need of higher power is indicated. In such case, turn the powerstat knob **W**, Fig. 7, page 8 to a somewhat higher setting and try again until a satisfactory bond is produced. At this point observe the number of the mark **H2**, Fig. 8, page 9 on the tuning dial **V4**, Fig. 8, so that the same tuning can be applied for further bonding of the same material.

**CAUTION**—If the power setting is too high, the material will burn or melt.

The lower speed-regulating knob **R2**, Fig. 9, at the front side of the machine, is for slowing the speed of the feeding action when bonding additional plies of material. Maximum speed is obtained with the pointer on this knob at "0." For lower speeds, turn this knob clockwise.

Set the knob **R2** to produce a low speed and, when extra plies of material are encountered during the bonding operation, depress the compensating feed treadle **D**, Fig. 7. This will slow the feeding action and is designed to provide the extra time required for bonding additional plies of material. Release treadle **D** after the additional plies of material have been crossed and bonding is resumed on the fewer plies of material.

The two screws **Z2**, Fig. 9, page 10 are for the purpose of taking up any looseness which may develop in these knobs.

**IMPORTANT**—Several pieces of crocus cloth accompany this equipment. Occasionally draw a piece of this crocus cloth back and forth between the two electrodes while the upper electrode (the bonding foot) is down upon the lower electrode; then reverse the cloth so that the bonding surface of both of the electrodes will have been affected by this procedure. The purpose is to remove any corrosion which may occur on the bonding surfaces of the electrodes. **Never use emery cloth for this purpose.**

## TO REMOVE AND REPLACE THE BONDING FOOT

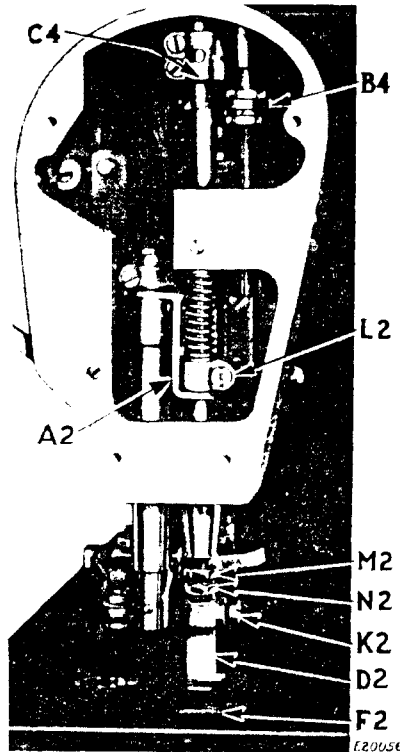

Fig. 11. Removing and Replacing Bonding Foot Adjusting Bonding Foot Bar (with Filling Plate Removed)

With bonding foot D2 resting on electrode F2, loosen clamp L2 and raise it until there is a clearance of approximately 1/16 inch between bonding bar lifting link A2 and clamp L2, then tighten clamp L2 in this new position.

### TO SET BONDING FOOT AT CORRECT HEIGHT

In general, the bonding foot D2, Fig. 11 should be set so that, at the top of its stroke, as indicated by arrow on balance wheel of arm shaft, (see Fig. 11A), the space between the bottom of the bonding foot D2 and the top of the electrode F2, Fig. 11 will be approximately twice that of the thickest portion of the material being bonded. However, the space between the bottom of the bonding foot and the top of the electrode F2 should never be less than .015 inch regardless of how thin the material

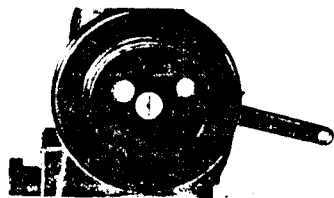

Fig. 11A. Showing Arrow on Arm Shaft. (Indicating Bonding Foot at Top of Stroke)

Raise lifting lever at rear side of machine head to raise the presser bar and the bonding bar. Loosen set screw K2, Fig. 11 in bonding foot D2. Take out the four screws which fasten the face plate to the machine head, to remove the face plate.

Press upward from the under side of clamp L2 against the tension of bonding bar spring, and slip the bonding foot from the bonding bar. However, if this procedure does not provide sufficient clearance between lower end of bonding bar and electrode F2 to permit removal of bonding foot, loosen the two nuts M2 and N2 and turn them downward on the bonding bar so that the bar can be raised slightly higher to permit removal of the bonding foot.

When replacing bonding foot, turn nuts M2 and N2 upward sufficiently to permit bonding bar to descend fully into the bonding foot when the lifting lever at rear side of machine head is released while the bonding foot is resting upon the electrode F2. Tighten set screw K2 while making certain that the bottom of the bonding foot exactly aligns with the electrode F2.

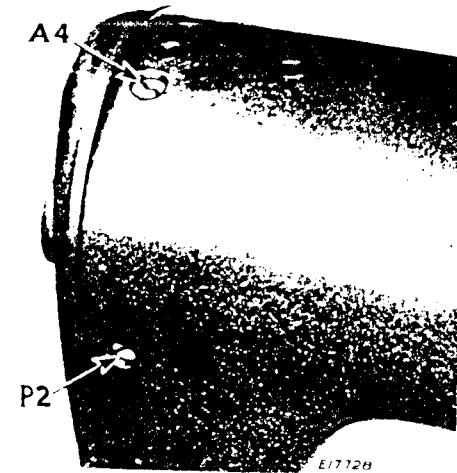

Fig. 12. Adjustment for Bonding Foot Bar

may be. An exception to this setting would be when the machine is adjusted for high feeding speeds, in which case the space between the bottom of the bonding foot and the lower electrode should be correspondingly increased.

The above adjustment is attained by means of the nuts M2 and N2 as shown in Fig. 11. First loosen set screw K2, Fig. 11, then loosen lock nut M2 and turn adjusting nut N2 up or down until the desired height of foot is obtained, then tighten set screw K2 and turn lock nut M2 firmly against the adjusting nut N2.

While the foregoing adjustment sets the bonding foot D2 the desired height above the electrode F2, it does not provide a positive limit of descent for the bonding foot. Positive limit of descent is achieved by loosening set screw P2, Fig. 12 at the front side of the machine head and with bonding foot at bottom of stroke, as indicated by position of arrow on balance wheel end of arm shaft, and turning adjusting screw A4, Fig. 12 up or down until the bonding bar stop plate B4, Fig. 11 contacts the bottom of the bonding bar lifting bracket C4, Fig. 11.

While it is advisable to make use of the adjustment provided by the screw A4, Fig. 12 to limit the descent of the bonding foot to a distance slightly below the top surface of the material being bonded such adjustment is not absolutely necessary.

**NOTE**—It is not necessary to remove the face plate to make this adjustment. The face plate is removed in Fig. 11 only for the purpose of illustrating the mechanism affected by turning the adjusting screw A4, Fig. 12.



## TO CHANGE FROM RIGHT HAND FEED TO LEFT HAND FEED

The machine can be arranged for either right hand feed or left hand feed. Right hand feed is with the feed disc **Q2** at the right of the electrode **F2** as shown in Fig. 13. This arrangement is adaptable for use with attachments.

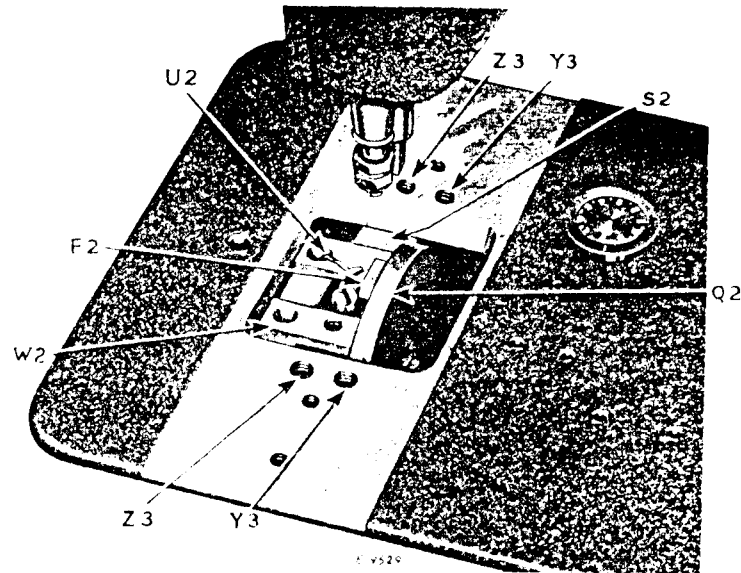

Fig. 13. Machine Arranged for Right Hand Feed

Left hand feed is with the feed disc **Q2** at the left of the electrode **F2** as shown in Fig. 18, page 18. This arrangement of the feed is for "free" bonding, i. e., without the use of attachments.

To change from right hand feed to left hand feed, remove throat plate and remove roller presser.

Disconnect the compensating feed chain from its treadle (the treadle at the extreme right beneath the table). Lay the machine back on the rest pin and remove the tuning knob **J2**, Fig. 14. Remove the eight screws which fasten the cover **O2**, Fig. 14 to the tuning unit housing at the under side of the machine bed.

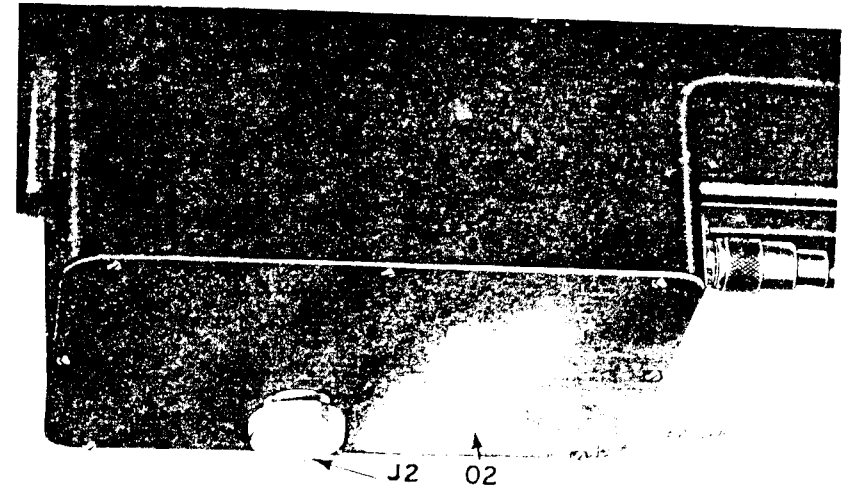

Fig. 14. Tuning Unit Housing and Tuning Unit Knob

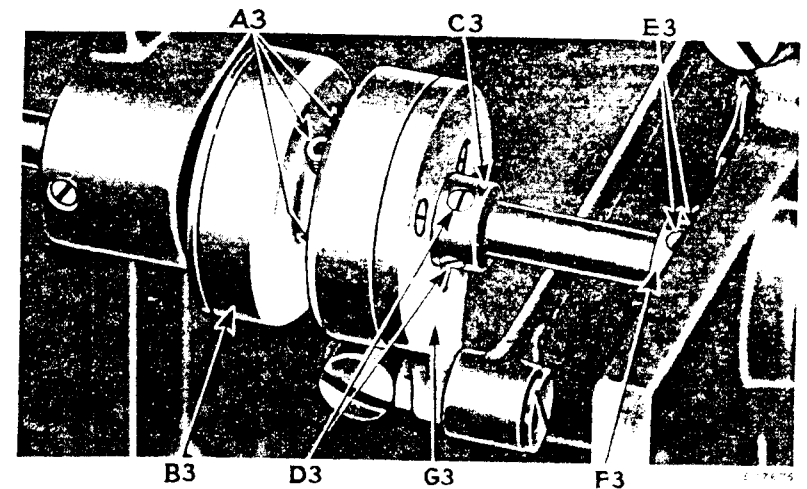

Fig. 15. Feed Clutch and Lower End of Feed Forked Connection

Loosen the two screws X2, Fig. 16 in the hub of the feed disc; also loosen the three screws A3, Fig. 15, page 15 in the feed clutch B3, Fig. 15. Loosen the two screws D3, Fig. 15 in clutch collar C3, Fig. 15, and loosen the two screws E3, Fig. 15 in the stop collar F3, Fig. 15. Then, while holding drive plate G3, Fig. 15 against the clutch, to prevent the clutch from springing apart, move the feed shaft sufficiently to the right to permit removal of feed disc Q2, Fig. 16.

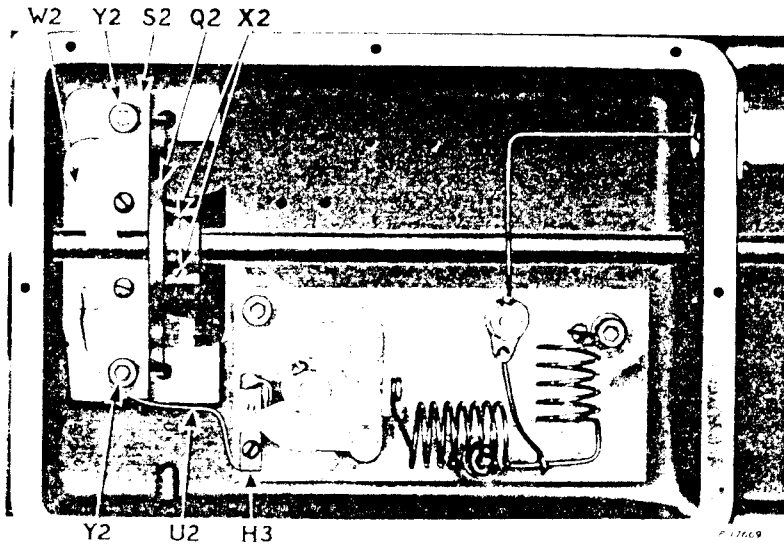

Fig. 16. Machine Arranged for Right Hand Feed  
View at Under Side of Machine Bed

Loosen clamp screw H3, Fig. 16 which holds the wire U2 to the tuning unit mounting plate. Remove the two Allen head screws Y2, Fig. 16 which fasten insulating block holder S2 to the under side of machine bed; then remove the unit consisting of insulating block holder S2, insulating block W2, electrode F2, Fig. 13, page 14 and wire U2. Be careful not to injure the wire when removing this unit from the machine.

Place the feed disc Q2, Fig. 17 on the feed shaft, having the hub of the disc to the left as shown in Fig. 17; then place the unit consisting of block holder S2, insulating block W2, electrode F2, Fig. 18, page 18 and wire U2, in position against the under side of the machine bed and to the right of the feed disc as shown in Fig. 17. Fasten this unit in place with the two Allen head screws Y2, having these two screws in the holes Y3, Fig. 13.

**NOTE**—The holes Z3, Fig. 13 are for the Allen head screws when the machine is arranged for right hand feed.

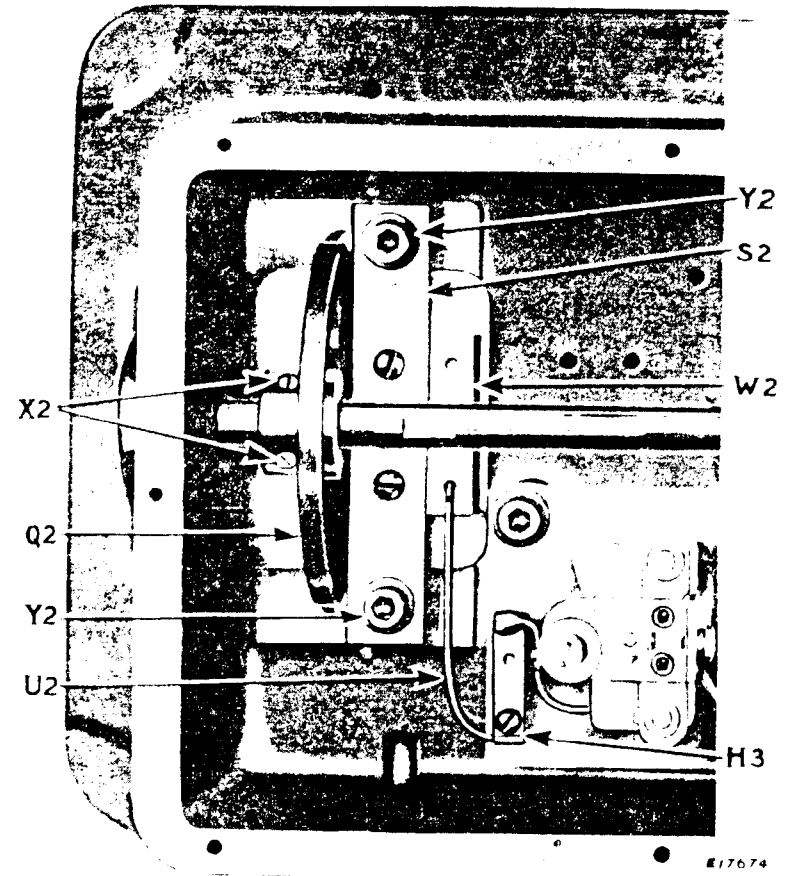

Fig. 17. Machine Arranged for Left Hand Feed  
View at Under Side of Machine Bed

Fasten the wire U2 to the tuning unit clamp by means of the screw H3 as shown above.

**CAUTION**—Make certain that this wire does not touch any metal part of the machine, except the proper connections at its ends.

Now move the feed shaft to the left where one of the two screws X2, Fig. 17, in the hub of the feed disc, will bear against the left hand one of the two flats at this end of the shaft. Tighten one of these two screws against the left hand flat, and tighten the other screw against the shaft. The feed disc Q2 should be set with relation to the lower electrode F2, Fig. 13, so that the space between the electrode F2 and

the feed disc **Q2** will be .050 inch. (When it is found necessary to reduce this distance to less than .050 inch, use the rubber-covered, non-metallic feed disc especially designed for this purpose). Tighten the two screws in the clutch collar **C3**, Fig. 15, page 15 against the drive plate **G3**, Fig. 15. Tighten one of the three screws **A3**, Fig. 15, in the clutch **B3**, Fig. 15, against the flat on the shaft, and tighten the other two screws against the shaft. With the stop collar **F3**, Fig. 15 against the bushing at the right hand end of the feed shaft, tighten the two screws **E3**.

Fasten the cover **O2**, Fig. 14, page 15 to the tuning unit housing by means of the eight screws as shown in Fig. 14, then replace the tuning unit knob **J2**, Fig. 14 to the tuning unit shaft.

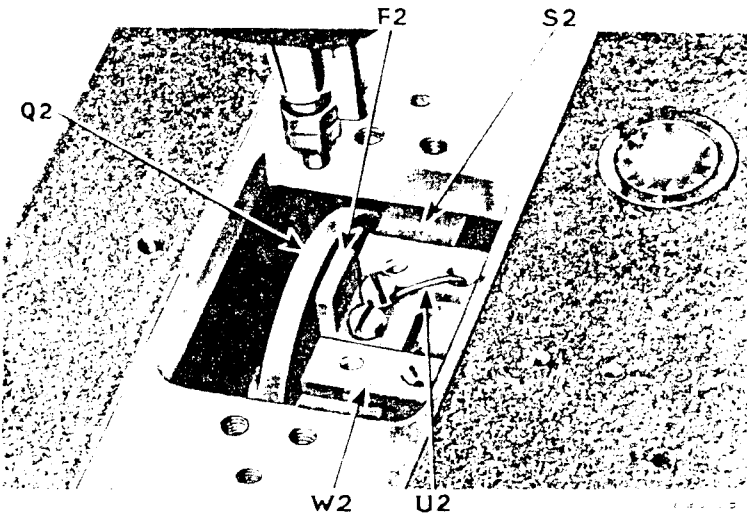

Fig. 18. Machine Arranged for Left Hand Feed

Return the machine to its upward position and attach the left hand roller presser to the presser bar. The roller presser must be set with relation to the under feed disc **Q2**, as instructed on page 19 under "To Remove, Replace and Adjust Roller Presser."

Attach the lower end of the compensating feed chain to the compensating feed treadle.

## TO REMOVE, REPLACE AND ADJUST ROLLER PRESSER

Remove the face plate. Raise the presser bar by means of the lifting lever at the rear side of the machine head and, with the roller presser **C2** turned up as shown below, remove the roller presser screw **J3**, Fig. 20. Fig. 19 shows the roller presser for right hand feed, while Fig. 20 shows roller presser for left hand feed.

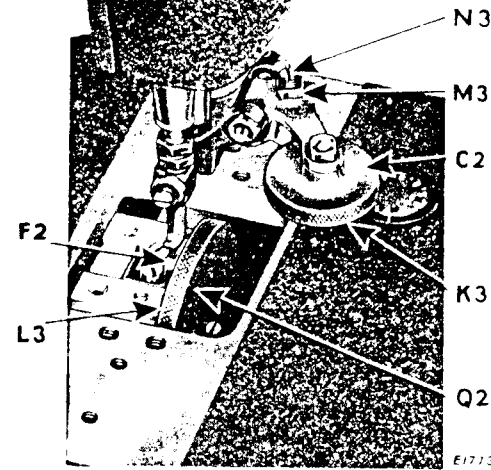

Fig. 19. Roller Presser for Right Hand Feed

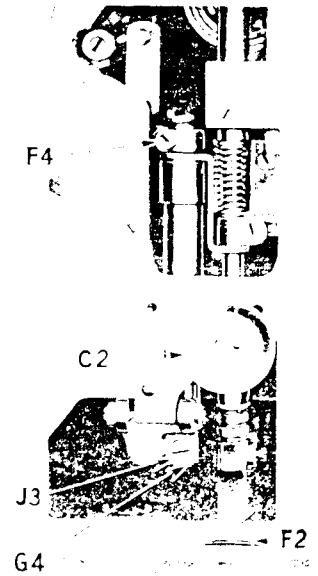

Fig. 20. Roller Presser for Left Hand Feed (With Filler Plate Removed)

Loosen clamping screw **F4**, Fig. 20 and turn the presser bar, a small portion of which is visible at **G4**, Fig. 20, in the opposite direction so that the seat for the roller presser will face to the right or to the left, depending upon which of the two roller pressers is to be attached. Then tighten clamping screw **F4** and attach the roller presser to the presser bar by means of the screw **J3**. The roller **C2** must be adjusted so that the inner edge **K3** of its rim exactly coincides with the edge **L3** of the rim of the feed disc **Q2**, with the feed disc .050 inch from the lower electrode **F2**. The edge **L3** of the feed disc and the edge **K3** of the roller presser, are the edges nearest the lower electrode **F2**.

To adjust for alignment of the edge of the roller **C2** with the edge **L3** of the feed disc, loosen nut **M3**, Fig. 19 and turn the screw **N3** in or out. When correct adjustment is obtained, tighten nut **M3**.

### TO TIME THE FEED

Feeding of the material should occur only while the bonding foot D2, Fig. 21 is off the material being bonded. The machine is correctly timed when it leaves the factory, and there should be no necessity for retiming.

However, should it later be considered necessary to retime the machine, proceed as follows:

Remove the two screws which fasten the arm side cover to the rear side of the machine arm, then loosen the two screws O3, Fig. 22 in the feed eccentric W3, Fig. 22.

While holding the feed eccentric W3, Fig. 22, turn the arm shaft, by means of the balance wheel, until the upper feed disc Q2, Fig. 21 moves only while the bonding foot is off the material being bonded.

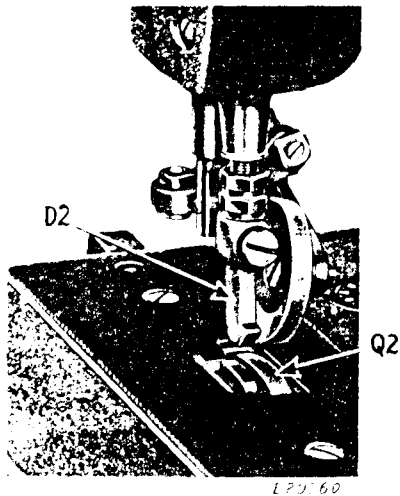

Fig. 21. Timing the Feed

**CAUTION**—No feeding movement should occur while the bonding foot rests upon the material being bonded.

Upon completion of this adjustment, replace the arm side cover.

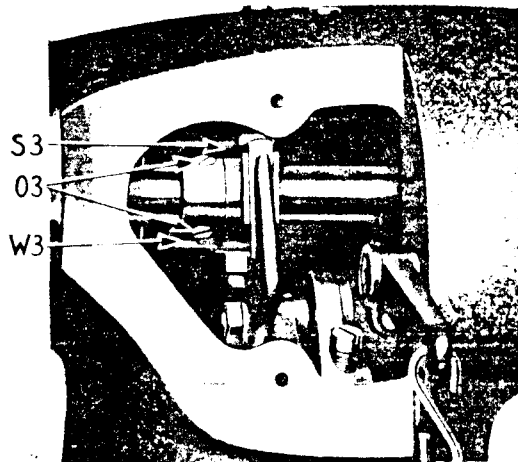

Fig. 22. Timing the Feed

### TO REMOVE AND REPLACE THE FEED ECCENTRIC

Take out the two screws which fasten arm side cover to machine arm, and remove arm side cover to gain access to the two screws O3, Fig. 23 in the feed eccentric collar.

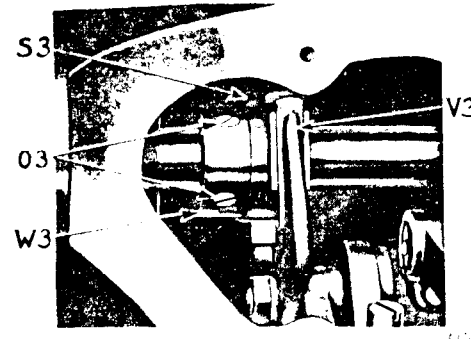

Fig. 23. Feed Eccentric and Upper End of Feed Forked Connection

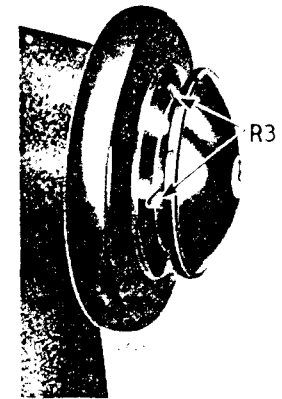

Fig. 24  
Removing Balance Wheel

Turn balance wheel until the two screws O3 are accessible through arm side cover opening as shown in Fig. 23, and loosen these two screws.

Loosen the two screws R3, Fig. 24 in balance wheel belt groove and remove balance wheel. Lay machine back on the rest pin and remove screw stud nut T3, Fig. 25 and screw stud U3, Fig. 25 from lower end of feed forked connection V3, Figs. 23 and 25 so that the feed forked connection can be pushed downward to release the feed eccentric sleeve S3, Fig. 23 and feed eccentric W3, Fig. 23. The feed eccentric W3 can then be removed from balance wheel end of arm shaft.

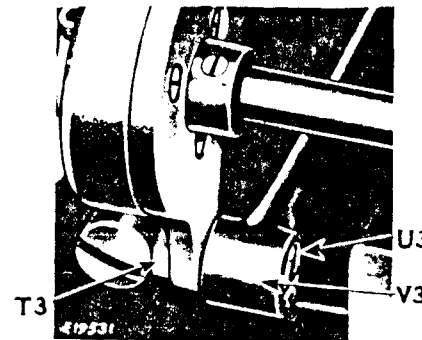

Fig. 25  
Lower End of Feed Forked Connection

When making replacement, reverse the foregoing operations for removal, making certain, when replacing balance wheel, that one of the two screws R3, Fig. 24 bottoms in the groove for same in the arm shaft, before tightening these two screws.

**IMPORTANT**—Whenever the balance wheel has been turned, while the feed eccentric screws O3 are loosened, the feed eccentric must be retimed. See "To Time the Feed," page 20.

### TO REMOVE AND REPLACE THE ELECTRODE-INSULATING BLOCK

Should the electrode-insulating block W2, Figs. 26 and 27 become burned as the result of faulty control of the voltage, it will be necessary to replace the block with a new one.

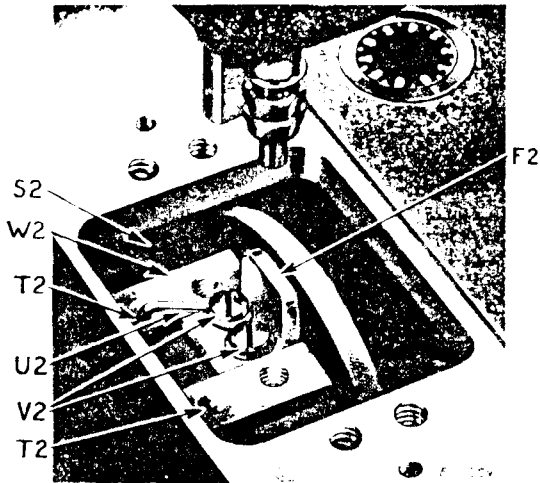

Fig. 26. Electrode Block in Place in Machine  
Left Hand Feed

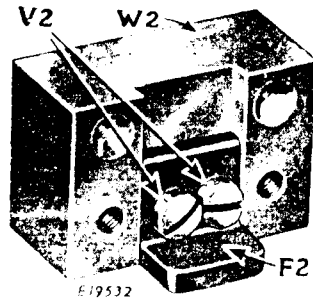

Fig. 27. Electrode Block with  
Electrode  
Removed from Machine

Remove throat plate and remove the two screws V2 to detach the electrode F2 and wire U2.

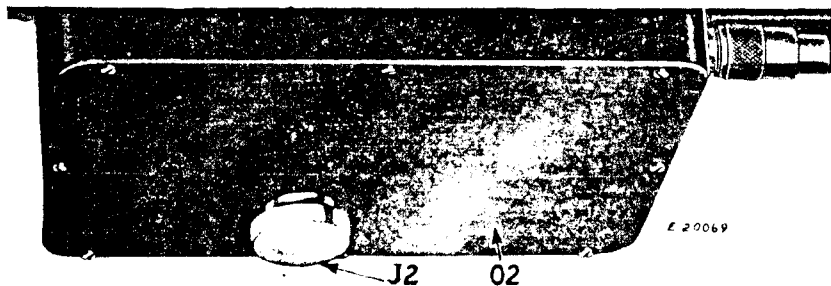

Fig. 28. Tuning Knob and Tuning Unit Housing Cover

Lay the machine back on the rest pin and remove the tuning unit knob J2, then remove the eight screws which fasten cover O2, thus removing the cover from the tuning unit housing.

Loosen clamping screw H3, Fig. 29 and detach wire U2 from the tuning unit. Remove the two screws X3, Fig. 29.

Return the machine to its upright position and, through the throat plate opening, remove insulating block W2.

Lay the machine back on the rest pin and fasten the replacement electrode block W2 to the block holder S2 by means of the two screws X3, then, from the top of the machine bed, pass the wire U2 downward through the rear one of the two holes T2, and fasten the electrode F2, Fig. 26

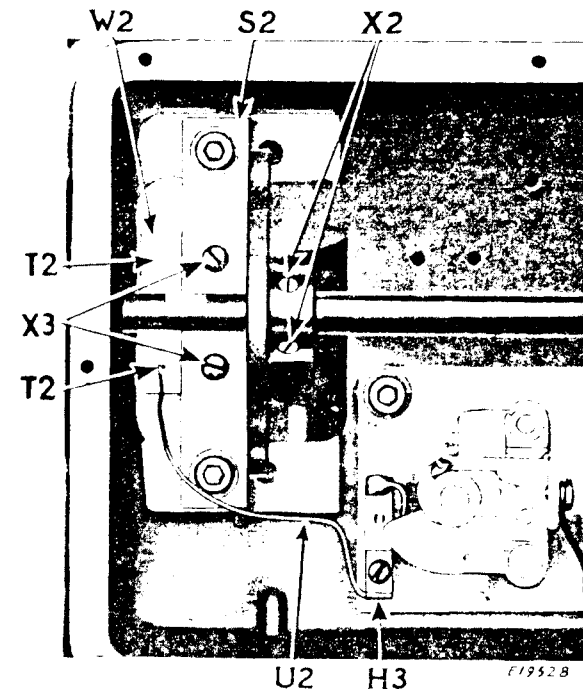

Fig. 29. Underside View Showing Electrode Block and  
Block Holder in Place in Machine

to the electrode block W2, by the front one of the two screws V2. Attach the loop at the end of the wire U2 to the electrode F2 by means of the rear one of the two screws V2 thus, at the same time, completing the attachment of the electrode to the electrode-insulating block.

At the under side of the machine bed, attach the lower end of the wire U2 to the tuning unit by means of the clamping screw H3, Fig. 29; then attach the tuning unit housing cover O2 to the tuning unit housing by means of the eight fastening screws. Attach the knob J2 to the tuning unit shaft.

### TO ADJUST THE MICRO-SWITCH

Before shipment, the micro-switch **S**, Figs. 30 and 31 is properly adjusted with relation to the transmitter to which it is connected. However, upon receipt of the equipment, a check should be made to determine that the micro-switch acts just as soon as the machine starts feeding, and ceases functioning when the machine stops feeding. The red light on the front of the oscillator shows when the micro-switch is "on." It goes out when the micro-switch is "off."

If the machine feeds the material before the micro-switch is on, there will be no seam until the micro-switch starts to act. If this switch acts before the machine starts feeding the material, the beginning of the seam will be too pronounced and not consistent with the rest of the seam.

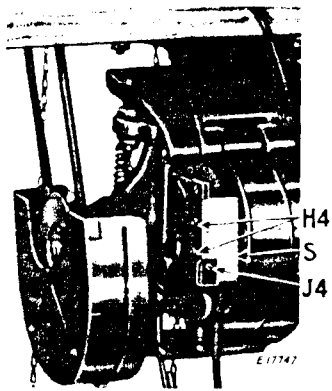

Fig. 30  
Micro-Switch Attached to Transmitter

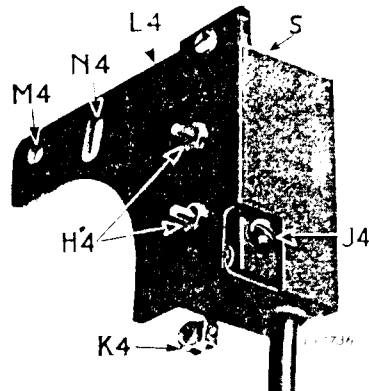

Fig. 31. Micro-Switch Removed from Transmitter  
to Show Adjusting Nuts and Screw

To adjust, proceed as follows: Loosen the two nuts **H4**, Figs. 30 and 31 and turn adjusting screw **J4** clockwise or counter-clockwise until proper contact is made between the small roller **K4**, Fig. 31 and the cam on the yoke of the transmitter. Then tighten the two nuts **H4**.

If the above adjustment of the micro-switch, by means of adjusting screw **J4**, should prove inadequate, additional adjustment is obtained by loosening the two screws which fasten the switch bracket **L4** to the transmitter. These two screws are not shown in these illustrations, but their location is indicated by the holes **M4** and **N4**.

### TO SET THE BONDING BAR LIFTING BRACKET ROLLER WITH RELATION TO THE BONDING BAR LIFTING ECCENTRIC

If, for any reason such as adjustment or replacement, the two screws **P4**, Fig. 32 should be loosened, it is essential that the lifting bracket roller, a small portion of which appears at **R4**, in Fig. 32, be positioned exactly in line with the bonding bar lifting eccentric (not shown in Fig. 32). Fig. 33, shows the lifting bracket **C4** with roller **R4** attached; also the bonding bar lifting eccentric **S4** which is attached to the front end of the arm shaft.

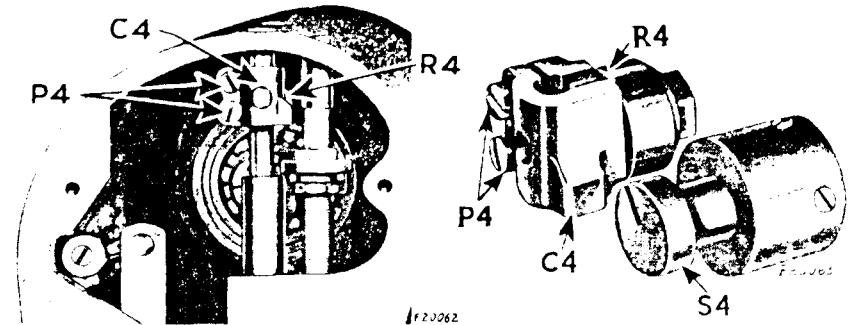

Fig. 32  
Bonding Bar Lifting Bracket and Roller  
in Place in Machine

Fig. 33. Bonding Bar Lifting Bracket and Roller  
and Bonding Bar Lifting Eccentric  
Removed from Machine

The contacting surfaces, respectively, of the roller **R4** and eccentric **S4** must be exactly in line with each other so that the eccentric **S4** will impart a complete rolling action to the roller **R4**, otherwise the two surfaces will rub together, thus causing excessive wear.

After making certain that these two surfaces are in exact alignment with each other, as instructed above, and with the eccentric **S4** in its high position, a clearance of .050 inch should be established between the bonding foot and the lower electrode while the bonding bar is fully inserted into the bonding foot, tighten the two screws **P4**.

**NOTE**—This is the correct setting for the bonding bar.

For bonding foot adjustment, follow the instructions on pages 12 and 13.

TECHNICAL SUMMARY  
OF  
**TYPE G26 ELECTRONIC OSCILLATOR**

DESCRIPTION

The **SINGER** Electronic Oscillator Type G26 has been designed for use with the **SINGER** Electronic Seamer in the fabrication of articles of thermo-plastic film by means of high frequency electronic bonding.

ELECTRICAL CHARACTERISTICS

Power Output.....100 Watts  
Frequency.....62 Megacycles

**Power Supply Requirements:**

115 Volts, 50-60 Cycles, single phase.

Capable of supplying 350 watts at 85 per cent. power factor.

(NOTE:—An additional 450 watts are necessary for the **SINGER** Electric Transmitter).

TUBE COMPLEMENT

Oscillator.....2 TYPE 809  
Rectifier.....2 TYPE 866 866A

MECHANICAL SPECIFICATIONS

**Dimensions:**

Height.....25 inches  
Width.....12-½ inches  
Depth.....13-½ inches  
Weight.....100 lbs. (approx.)

OSCILLATOR CONSTRUCTION

All components of the oscillator, except the coaxial cable and the output coupling unit, are mounted in a steel cabinet equipped with carrying handles.

The following items, illustrated in **Fig. 34**, are located on the front panel of the oscillator: plate circuit milliammeter **M1**; "ON-OFF" power supply switch **S1**; power control **T4**; spot seal switch **S2**; "FILAMENT-ON" indicator light **I-2**; and "PLATE-ON" indicator light **I-1**. Output connector **J2** is located on the left hand side of the cabinet.

As shown in **Fig. 35**, all the components of the oscillator are readily accessible when the hinged rear door is opened.

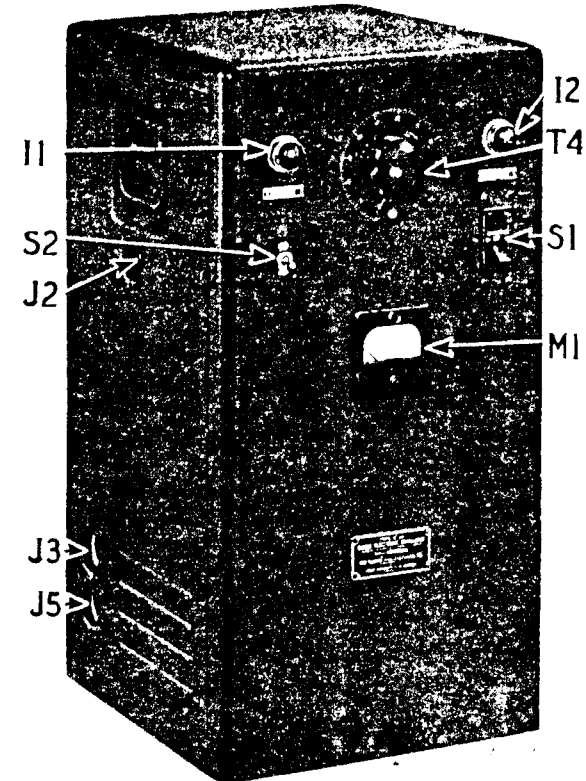

Fig. 34. Front View of Oscillator

CIRCUITS

The complete electrical circuit of the oscillator is shown in the schematic diagram, **Fig. 36**.

CONTROL AND POWER SUPPLY

The incoming 115 volt 50-60 cycle, single phase power supply is connected to the equipment through the three-wire power line receptacle **J1** which is located at the lower right hand corner of the rear panel of the cabinet. Power for the **SINGER** Electric Transmitter is obtained from the receptacle **J5**, **Fig. 34**, located at the bottom of the left hand side of the cabinet.

Power to the equipment is controlled by operation of the "ON-OFF" "POWER" switch S1. This switch is equipped with a magnetically operated cut-out which provides protection to the equipment in the event of a short

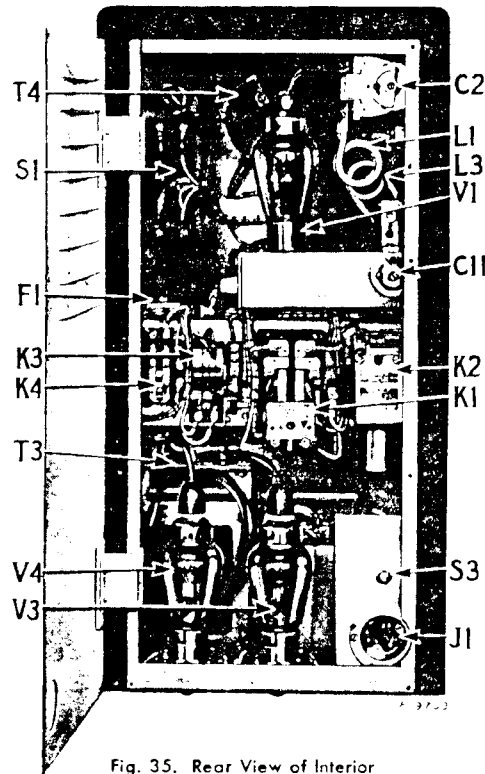

Fig. 35. Rear View of Interior

circuit or heavy overload. Added protection to the motor circuit is provided by a 15 ampere plug fuse F1, which is easily replaceable. Protection for the mercury vapor rectifier tubes is provided by the time delay relay K3. This relay is adjusted to insure a 30-second delay between the application of filament power and bonding power. When the "POWER" switch is placed in the "ON" position, the SINGER Electric Transmitter Motor will run, filaments of all tubes will be energized and the "POWER-ON" indicator lamp 1-2 will light. At the same time the coil of the time delay relay K3 will be energized. After a delay of approximately 30 seconds, the contacts of this relay will close and complete the circuit to the plate contactor K1, applying a plate voltage to the oscillator tube anodes. Closing the contacts of the "SPOT-SEAL," switch S2 will complete the cathode circuit of the oscillator by closing relay K4.

Operation of the Electronic Seamer produces the same result, by closing the micro switch located on the SINGER Electric Transmitter.

## HIGH FREQUENCY

The high frequency circuit employed in the equipment is factory tuned and consists of a self-excited oscillator in which two oscillator tubes are connected for push-pull operation in a tuned-plate, tuned-grid circuit. The plate circuit consists of a variable condenser C2 and coil L1, while C11 and L2 comprise the grid circuit. The total plate current for both tubes is indicated on the O-300 milliammeter M1.

The output circuit consists of a two-turn pick up coil L3 which is inductively coupled to the plate tank coil L1 and is terminated at the connection J2.

## INSTALLATION OF OSCILLATOR

After the equipment has been unpacked the following procedure should be followed:

1. Remove the four retaining screws along the right hand side of the rear door so that the door may be swung open. As shipped, the equipment is wired for 115 volt, 60 cycle operation. The connections within this equipment will require no change unless the line voltage is less than 110 or more than 120. If the measured line voltage is either less than 110 or more than 120, make the following changes: Transfer the leads from the terminals marked 115 on transformers T1, T2 and T3 to the terminals on these transformers which are marked nearest in value to the measured line voltage.

**IMPORTANT:** Remove scotch tape on relays K1, K2 and K4, used to keep relays from vibrating during shipment.

2. Install the four vacuum tubes. The sockets for the two type 866 866A rectifier tubes V3 and V4 are located at the bottom of the cabinet. These tubes are inserted by aligning the pin on the tube base with the locating slot in the socket shell. A slight twist to the right locks the tube properly in its socket. **Do not** attach the plate cap connectors to the top of the rectifier tubes. For best results, the two oscillator tubes V1 and V2 should be a matched pair sold by Singer Sewing Machine Company for use in the SINGER Electronic Oscillator. Insert the oscillator tubes in the sockets on the high frequency oscillator chassis located near the top of the cabinet. These tubes are inserted so that the pin on the tube base faces the right side as viewed through rear door. The two plate connectors should be placed securely on the caps of the top of the oscillator tubes. It is important that the tubes are seated firmly in their sockets.
3. Close the rear door, replace screws and insert the three-wire power cord in its receptacle J1. Insert the three-wire cap into a power line outlet of suitable voltage and frequency. The "SPOT-SEAL" Switch S2 should be "OFF" and the power control T4 should be at ZERO. Then operate the "ON-OFF" line switch S1 to the "ON" position. Allow the power to remain on for about 30 minutes. This step is necessary to drive mercury globules from the filaments of the rectifier tubes and to distribute the vapor properly within those tubes. This initial warm-up need not be repeated unless the rectifier tubes have been replaced or otherwise disturbed.



4. After the rectifier tubes **V3** and **V4** have been aged as outlined in step 3, operate the "ON-OFF" switch to the "OFF" position and disconnect the power supply cord from the equipment. Then open the rear door and attach the plate cap connectors to the top of the rectifier tubes **V3** and **V4**. Close door, replace screws, and re-connect the power supply cord. Connect the coaxial cable to its connector **J2**, on the upper left-hand side of the cabinet. The other end of this cable attaches to the connector below the bed of the bonding machine head. Insert the **SINGER** Electric Transmitter cord connector in its receptacle **J5** located on the lower left-hand side of the cabinet. The polarized plug from the transmitter should be inserted in the receptacle **J3** located immediately above **J5**. The equipment is now ready for operation.

### OPERATION OF OSCILLATOR

After all cord connections have been made as described, the equipment may be placed in operation by operating the "ON-OFF" power switch **S1** to the "ON" position. The "POWER-ON" light (yellow **I2**) will light and the **SINGER** Electric Transmitter Motor will run. Bonding power will be available after the 30 seconds time delay imposed by the time delay relay **K3**. This delay is necessary in order that the tubes reach operating temperature before plate voltage is applied.

After the elapsed time delay, bonding power may be applied by operating either the foot treadle on the machine for continuous bonding, or by operating the "SPOT-SEAL" switch **S2** on the generator front panel for spot sealing. The amount of bonding power is controlled by the "POWER" control **T4** on the oscillator panel. When bonding power is applied, the "POWER-ON" red light **I-1** will operate, and the plate current milliammeter **M1** will give an indication. The tuning control **C9** (also shown at **J2**, Fig. 28, page 22), located on the underside of the machine head should be adjusted so that a maximum reading is obtained on the milliammeter. This adjustment should be made while the machine is bonding continuously at the desired speed with the "POWER" control set at approximately 30 to 40 on the dial. After a maximum reading is obtained on the milliammeter has been obtained, the "POWER" control may be advanced clockwise until a satisfactory bond results. The amount of power required will, of course, depend on the bonding speed and the physical and electrical characteristics of the material being bonded more power being required for thicker material and higher speeds.

### MAINTENANCE OF OSCILLATOR

With ordinary care, little service will be required to keep this equipment in operation. However, a regular schedule of inspection should be established.

It is desirable that the equipment be kept clean and free from dust, and for this purpose a small electric hand blower may be used to advantage. Relay contacts may be cleaned by applying carbon tetrachloride with a soft brush.

After cleaning, the contacts may be burnished with a burnishing tool.

When it becomes necessary to replace oscillator tubes, due to a failure of one or both, replace both tubes with a matched pair sold by Singer Sewing Machine Company. To replace but one tube would cause the new tube to carry the greater part of the load, thereby substantially reducing its life.

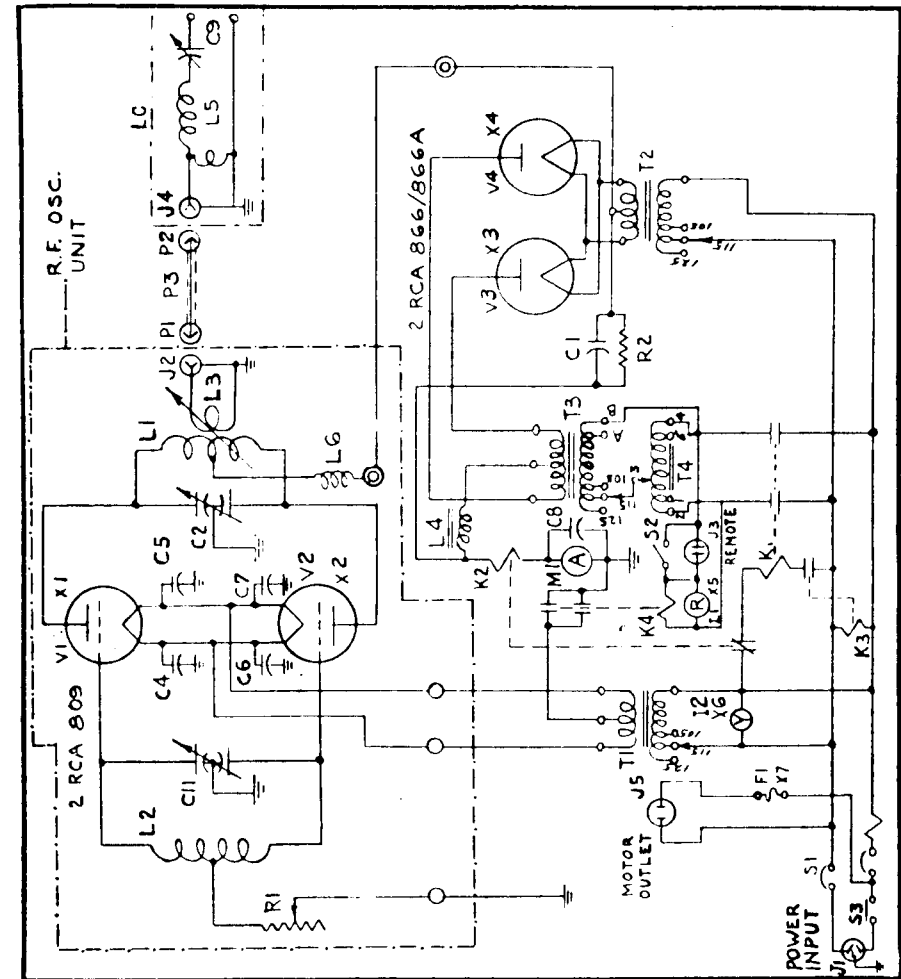

Fig. 36

Schematic Wiring Diagram for SINGER Electronic Oscillator

## LIST OF PARTS AS DESIGNATED BY SYMBOLS IN FIGURE 36

Symbol Number	Part Number	Description	Unit
C1	195574	Condenser, Filter 4 MFD, 1500 V. D. C.	1
C2	195575	Condenser, Variable, Plate Tank	1
C-4-5-6-7	195576	Condenser, Filament By-Pass 10,000 M MFD	4
C8	195577	Condenser, Meter By-Pass 0.001 MFD	1
C9		Condenser, Variable, Output Tuning	1
C11	195579	Condenser, Variable, Grid Tuning	1
F1	195463	15 Ampere Fuse	1
I1-2	195460	Lamp, Indicator, 120 V., 6 Watts	2
J1	195581	Receptacle, Line Input	1
J2-4	195582	Receptacle, Co-axial Cable	2
J3	195583	Receptacle, Foot Switch	1
J5	195580	Receptacle, Motor	1
K1	195584	Relay, Plate Contactor	1
K2	195585	Relay, D. C., Overload	1
K3	195586	Relay, Time Delay	1
K4	195587	Relay, Keying	1
L1		Coil, Oscillator Plate Tank	1
L2		Coil, Oscillator Grid Tank	1
L3		Coil, Output Coupling	1
L4	195588	Choke, Rectifier Filter	1
L5		Coil, Output Tuning	1
L6	195589	Choke, Plate	1
M1	195590	Meter, 0-300 MA D. C.	1
PI-2		Plug, Co-axial Cable	2
P3	195447	Cable, Co-axial, Connectors	1
R1	195591	Resistor, Grid 2000 Ohms, 25 Watts	1
R2	195592	Resistor, Bleeder 75,000 Ohms, 50 Watts	1
S1	195593	Switch, Line Breaker	1
S2	195594	Switch, Spot Seal	1
S3	195595	Switch, Door Interlock	1
T1	195596	Transformer, Oscillator Filament	1
T2	195597	Transformer, Rectifier Filament	1
T3	195598	Transformer, Plate	1
T4	195599	Transformer, Powerstat	1
X3-4	195600	Socket, Rectifier	2
X1-2	195601	Socket, Oscillator	2
X5	195602	Socket Indicator, Red Light	1
X6	195603	Socket Indicator, Yellow Light	1
X7	195604	Socket Ring	1
VI-2	195451	Oscillator Tubes, TYPE 809	2
V3-4	195452	Rectifier Tubes, TYPE 866 866A	2
	195445	Cable Input, Connectors	1
	195446	Adapter Plug, 2 to 3 Wire	1
LC	195511	Co-axial Cable Tuning Unit	1

Items not assigned part numbers are **not available** for replacement.