

SINGER^{*}
INDUSTRIAL PRODUCTS

OPERATOR'S GUIDE

6 9 1 CONSOLE

XS — 1 0 0 0
XS — 2 0 0 0
XS — 3 0 0 0

1. PREPARATION

1. SETTING THE SWITCHES

Set switches inside the motor control box as instructed below in accordance with the console used.

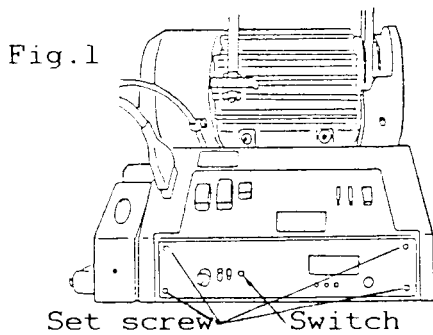
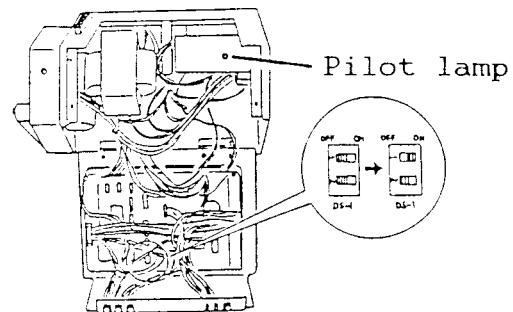

Fig. 2



(1) When console XS-1000 is used

- ☞ Set switch shown in Fig. 1 above to "ON". (Lower side)
If there is no switch on the control box as shown in Fig. 1 above, follow instructions below.
 - a) Remove the four screws in the control box and open the cover after making sure the power is turned off. (Fig. 1)
 - b) Set switch DS1-1 to "ON" position as shown in Fig. 2.
 - c) Close cover and secure in place with four screws.

(2) When consoles XS-2000 & XS-3000 are used

- ☞ Set switch shown in Fig. 1 to "OFF". (Upper side)
If there is no switch on the control box as shown in Fig. 1, follow instructions below.
- ☞ Switch DS1-1 in the control box shown in Fig. 2 is set in "OFF" position when shipped from the factory however, check and make sure it is in "OFF" position when using consoles XS-2000 or XS-3000.

CAUTION: Do not touch any parts inside the control box if the pilot lamp (Fig. 2) is "ON" when the cover is opened. The pilot lamp will turn off a little while after the power switch is turned off therefore setting of the switches should be done after the pilot lamp turns off.

2. CONNECTING THE CABLE (XS-2000, 3000)

Fig. 3

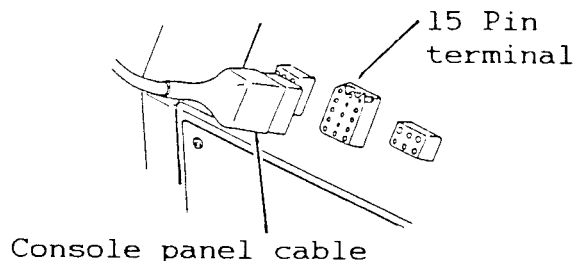

Pass the cable from the console through the hole provided for it in the machine table and connect it to the 15 pin terminal on the control box. (Fig. 3)

NOTE: Be sure the cable is free from interference with the motor belt.

2. SEWING PATTERNS AND FUNCTION OF SWITCH

XS-1000

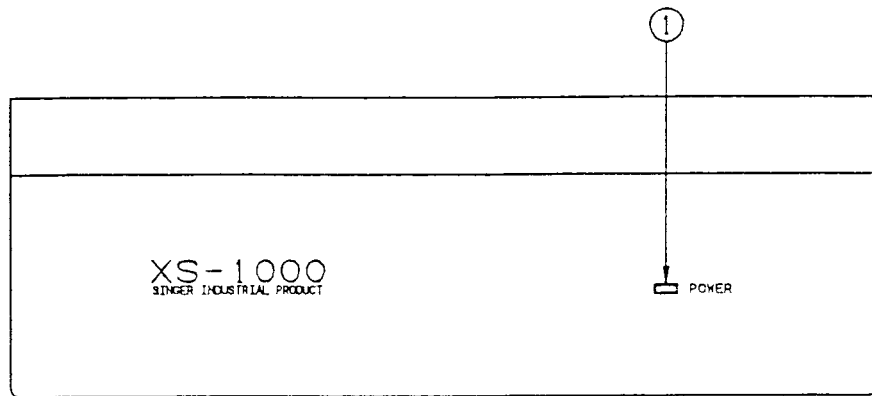

XS-2000

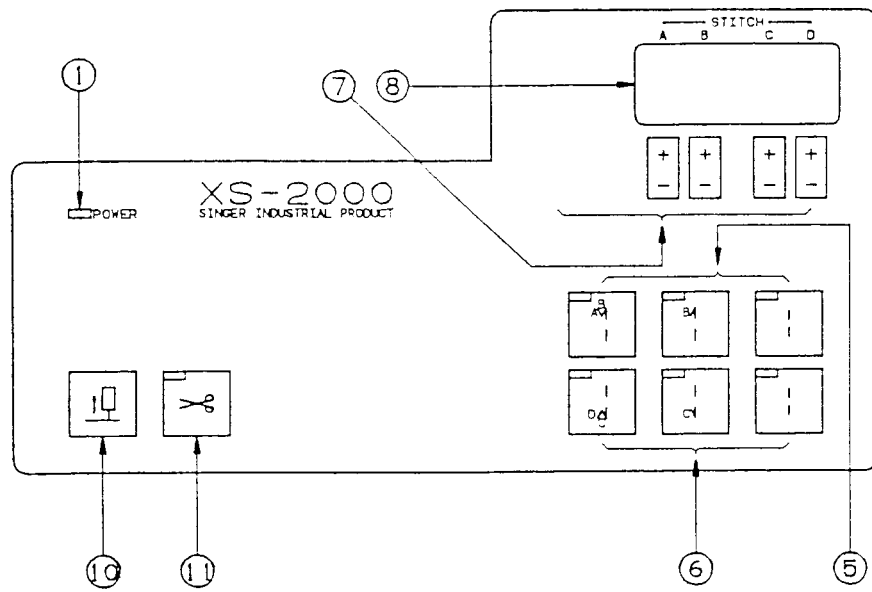

XS-3000

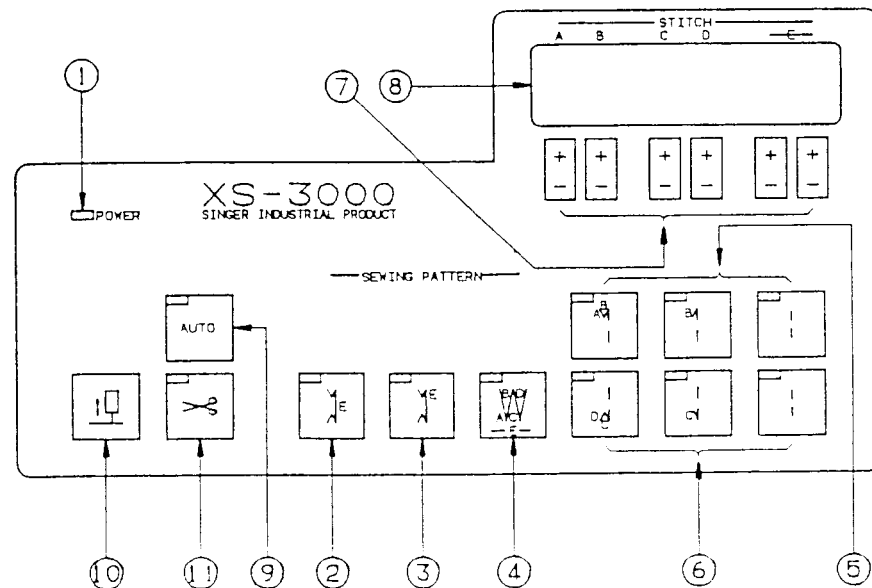

- 1 PILOT LAMP
 - *Lamp will light up when power switch is turned on.
- 2 SWITCH FOR STITCH COUNT MODE
 - *Switch used for stitch count sewing.
 - *LED at upper left corner will light up when switch is pressed.
- 3 SWITCH FOR STITCH COUNT MODE PLUS MANUAL SEWING
 - *Switch used for stitch count and manual sewing.
 - *LED at upper left corner will light up when switch is pressed.
- 4 SWITCH FOR LINE TACKING
 - *Switch used for line tacking.
 - *LED at upper left corner will light up when switch is pressed.
- 5 SWITCH FOR START BACK TACK
 - *Switch used for back tacking at start of sewing.
 - *LED at upper left corner will light up when switch is pressed.
- 6 SWITCH FOR END BACK TACK
 - *Switch used for back tacking at end of sewing.
 - *LED at upper left corner will light up when switch is pressed.
- 7 SWITCH FOR SETTING STITCH COUNT
 - *Switch for setting number of stitches from A TO E.
 - *A - D - - - - - 0 - 9 stitches
 - *E - - - - - 1 - 99 stitches
 - *+ mark - - - - - Used for increasing number of stitches.
 - *- mark - - - - - Used for decreasing number of stitches.
- 8 STITCH COUNT DISPLAY LED
 - *LED displays the stitch count from A to E set with above count switch 7.
- 9 SWITCH FOR AUTOMATIC STITCHING
 - *Switch used to sew set number of stitches automatically without depressing the pedal until completion of a cycle.
 - *LED at upper left corner will light up when switch is pressed.
- 10 NEEDLE UP OR DOWN SWITCH
 - *When needle is in its lower stop position, it can be raised to upper stop position, and when in upper stop position it can be lowered to lower stop position by pressing this switch.
- 11 THREAD TRIMMER SWITCH
 - *This switch is used for setting the trimmer to trim, or not trim, the thread at completion of sewing.
 - *Set switch to "ON" for TRIMMING.
 - Set switch to "OFF" for NO TRIMMING.
 - *LED at upper left corner will light up when switch is pressed.

3. INSTRUCTIONS FOR USING THE CONSOLE

1. TO SET THE CONSOLE FOR BACK TACKING (XS-2000, 3000)

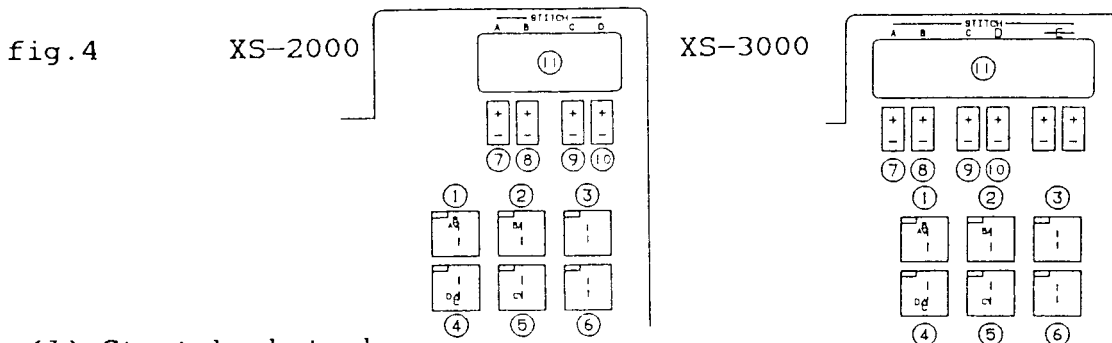

- (1) Start back tack
 - Select desired back tack pattern with one of the three switches (1) to (3) shown in Fig.4.
 - ☞ LED of the selected back tack switch will light up.
- (2) End back tack
 - Select desired back tack pattern with one of the three switches (4) to (6) shown in Fig.4.
 - ☞ LED of the selected back tack switch will light up.
- (3) To set number of stitches for back tack
 - Set number of stitches for each segment (A,B,C and D) of the back tack with switches (7) to (10) shown in Fig.4.
 - ☞ The LED will display the set number of stitches on screen (11).
 - * + mark---Switch for increasing number of stitches.
 - * - mark---Switch for decreasing number of stitches.

2. TO SET THE SEWING PATTERN (XS-3000)

- (1) To set the sewing pattern
 - Select one of the following patterns.

Fig.5

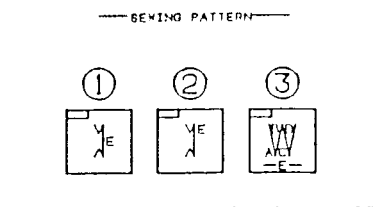

- *MANUAL SEWING
 - Manual sewing can be done only when LED on all switches, (1) to (3) shown in Fig.5, is off.
 - ☞ The LED can be turned off by repressing the switch.
- *STITCH COUNT MODE
 - Press switch (1) shown in Fig.5.
 - ☞ LED will light up when switch is selected.
- *STITCH COUNT MODE & MANUAL SEWING
 - Press switch (2) shown in Fig.5.
 - ☞ LED will light up when switch is selected.
- *LINE TACKING
 - Press switch (3) shown in Fig.5.
 - ☞ LED will light up when switch is selected.

(2) To set number of stitches

When sewing pattern other than manual sewing has been selected, set number of stitches as instructed below.

Fig.6

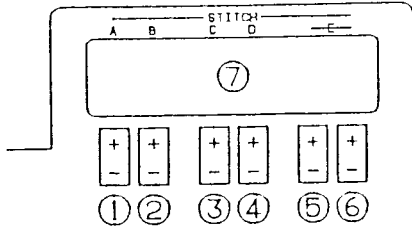

*STITCH COUNT SEWING

Set number of stitches desired for segment E with switches ⑤, ⑥ shown in Fig.6.

☞ The number of stitches set will be displayed on screen ⑦.

*LINE TACKING

Set number of stitches desired for segments A to D with switches ① - ④ shown in Fig.6.

☞ The number of stitches and number of seams will be displayed on screen ⑦.

For example, if "E" is set for 04 the machine will sew four seams in the order A to D.

NOTE:When stitch count sewing pattern is selected and if there is an error in the setting of stitch count, the LED will start flashing and the machine will not sew even when the pedal is depressed.

Fig.7 XS-2000

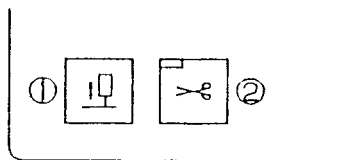

XS-3000

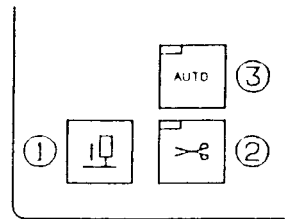

3. NEEDLE UP AND DOWN SWITCH (XS-2000, 3000)

The needle in lower stop position can be raised to upper stop position and when in upper stop position it can be lowered to lower stop position by pressing the needle up and down switch ① shown in Fig.7.

When needle up and down switch is pressed continuously, the machine will run at slow speed.

4. THREAD TRIMMER SWITCH (XS-2000, 3000)

Set thread trimmer switch ② shown in Fig.7 to "ON" to actuate the thread trimmer at completion of sewing.

☞ LED will light up when switch is pressed.

5. SWITCH FOR AUTOMATIC STITCHING (XS-3000)

When switch ③ shown in Fig.7 is pressed for stitch count mode and line tacking, the machine will sew automatically up to thread trimming at completion of sewing even when the treadle is released immediately after depressing it to start sewing.

If you wish to stop the machine after starting to sew, just heel back the pedal.

NOTE: It is possible to change the pattern and number of stitches in the middle of a pattern however, when pattern (with the exception of back tack pattern) is changed, the pedal must be heeled back to complete the pattern before the new pattern can be sewn.

6. IMPORTANT SAFEGUARD (XS-2000, 3000)

- ☞ Do not press switches with a sharp object such as ball pen and sewing picket, etc.
- ☞ When a machine is new or has been idle for a long period, the LED will start flashing when pedal is depressed and machine will not run. This is for confirmation of pedal curve data explained later in this manual and does not indicate breakdown of machine. When LED start flashing, return pedal to neutral and depress once again. The machine will return to normal condition.
- ☞ Do not plug in or unplug power line cord with power switch turned on.

4. SELECTION OF DIP SWITCH

The following special function can be made possible by altering the setting of the dip switch on rear of console. (Fig.8)

☞ Normally all switches are set "OFF". (Upper side)

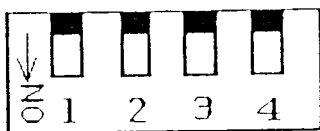

Fig.8

1. DIP SWITCH "1" : TEST MODE

☞ When dip switch "1" is turned ON, the display will change as shown below making it possible to test and adjust the console. (Refer to ADJUSTMENT OF CONSOLE)



2. DIP SWITCH "2" : SELECTION OF RAISING / LOWERING AUTOMATIC FOOT LIFT

☞ When dip switch is OFF, the presser foot is lowered when pedal returns to its neutral position at completion of all sewing operations with the exception of automatic sewing.

☞ When dip switch is ON, the presser foot will stay up in the raised position for the length of time it has been set, even when the pedal is returned to its neutral position after completion of all sewing operations. (Refer to item 5-4)

3. DIP SWITCH "3" : SETTING STITCH COUNT

☞ When dip switch is OFF, number of back tack stitches can be set within 0-9 stitches.

☞ When dip switch is ON, number of back tack stitches can be set within 0-15 stitches. (Display of number of stitches over 10 stitches will be abridged therefore, refer to following display when setting the stitch count)

10 Stitches ⇨	A	13 Stitches ⇨	d
11 Stitches ⇨	b	14 Stitches ⇨	E
12 Stitches ⇨	C	15 Stitches ⇨	F

4. DIP SWITCH "4" : SELECTION OF SPEED CONTROL (When optional ES-200 is used)

☞ Dip switch "4" can be used only when ES-200 (optional) is connected, therefore it should be turned OFF when ES-200 is not connected.

5. ADJUSTMENT OF CONSOLE

1. TO ADJUST PEDAL VOLTAGE

When pedal can not be operated in normal condition due to voltage variation, adjust pedal voltage as instructed below.

- (1) Turn dip switch "1" ON. (Test mode)
- (2) The following will be displayed on the screen when switch is pressed.



- (3) If figures under A and B do not conform to above, turn VR-1 shown in Fig.9 so that the figures will be "40".

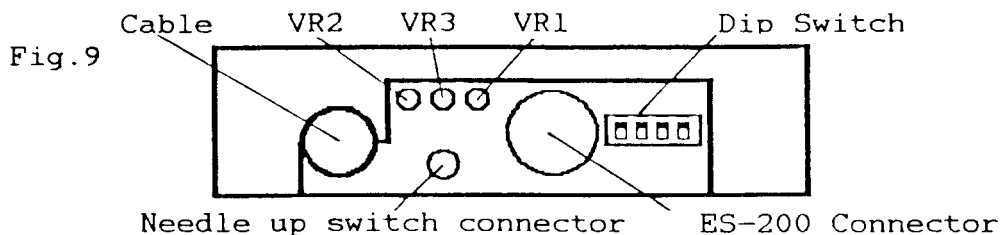

- (4) After making the above adjustment, check and make sure;

- *The motor will rotate when pedal is depressed.
- *The presser foot will rise when pedal is heeled back one step.
- *The trimmer will function when pedal is heeled back two steps.

If in case the following phenomenon is noted due to voltage variation, adjust pedal voltage as instructed below.

- *If presser foot rises when pedal is at its neutral position:
Adjust pedal voltage to slightly above 40.
- *If motor rotates when pedal is at its neutral position:
Adjust pedal voltage to slightly below 40.
- *If trimmer does not function when pedal is heeled back two steps:
Adjust pedal voltage to slightly below 40.

- (5) Press switch  and restore to initial test mode.

- (6) Turn dip switch "1" OFF.

2. TO ADJUST BACK TACK SPEED

Back tack speed can be varied from 1300-3000RPM in increments of 100RPM. (Adjusted to 1500 RPM when machine leaves the factory)

TO ADJUST

(1) Turn dip switch "1" ON.

(2) The following will be displayed on the screen when switch  is pressed.

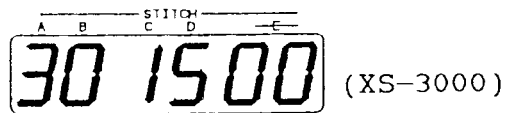
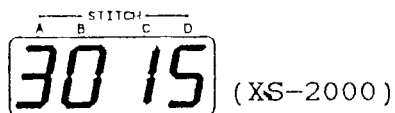

(3) The figures under C and D will change when VR2 shown in Fig.9 is turned.

- ☞ The figures under C and D in the display represent higher two digits of the back tack speed. (For instance, if the speed is 1500RPM, the figures displayed will be 15.)

(4) Press switch  and restore to initial test mode.



(5) Turn dip switch "1" OFF.

NOTE: When speed is increased, drifting of the stitches may occur. In such case, adjust with VR3 as instructed under "Adjustment of Back Tack Stitch" or with number of stitches.

3. ADJUSTMENT OF BACK TACK STITCH

Correct drifting of stitches which occurs during back tacking and line tacking (XS-3000) as instructed below.

ADJUSTMENT 1

(1) Press switches  and .

(2) Adjust VR3, fig.9, while actually sewing.

- ☞ When stitch formation is as shown in fig.10-A, correct by turning VR3 counterclockwise.
- ☞ When stitch formation is as shown in fig.10-C, correct by turning VR3 clockwise.
- * If adjustment can not be made with VR3, check the machine for cause of drifting.

Fig.10

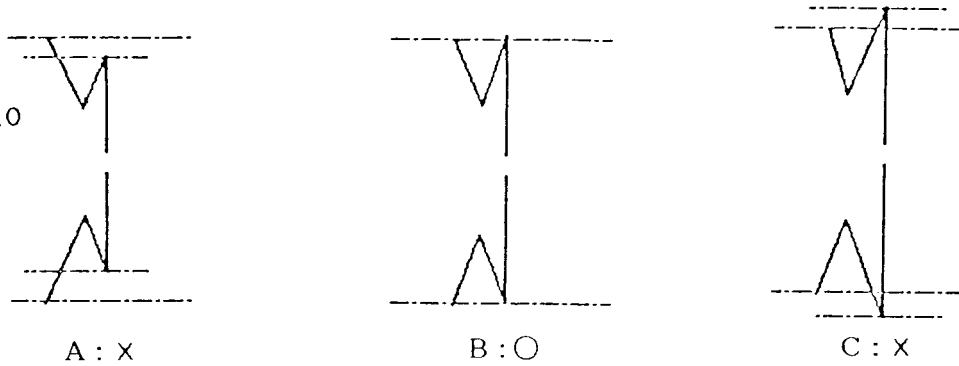

ADJUSTMENT 2



If correct stitch pattern as shown in Fig.10-B can not be obtained even after adjusting the machine and VR3, readjust as instructed below.

(1) Turn dip switch "1" ON.(Test mode)

(2) When switch  for no end back tack is pressed the display will change as shown below.



(3) Adjust by changing the figures displayed under A and B.

- ☐ The figures will increase in increments when switch  is pressed.
- ☐ The figures will decrease in increments when switch  is pressed.

* These figures are for changing the timing to energize the back tack solenoid and higher figures quickens the timing to energize the solenoid and stitch pattern will result as shown in Fig.11-A.

Lower figures will delay the above timing and stitch pattern will result as shown in Fig.11-B.

Fig.11

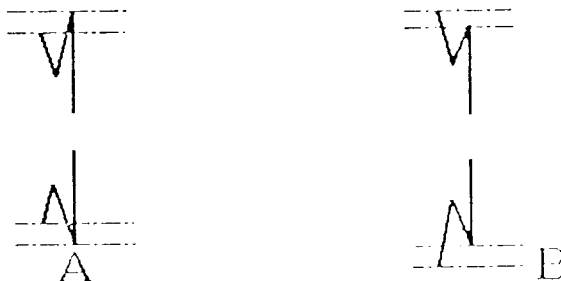

- ☞ When stitch pattern results as shown in Fig.11-A, decrease the figures.
- ☞ When stitch pattern results as shown in Fig.11-B, increase the figures.

- (4) When  switch is pressed, the display will change to initial test mode display.
- (5) Turn dip switch "1" OFF.

NOTE: The figures set under Adjustment 2 will be restored to initial figures 20 when machine is left idle for lengthy period and when pedal is depressed the LED will start flashing. In such case, the figures should be reset once more.

When power switch of a machine that has been left idle for a lengthy period is turned on, the display of the console would be as shown below.

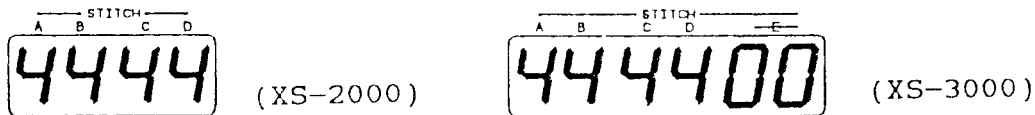



4. TO SET LENGTH OF TIME AUTOMATIC FOOT LIFT IS HELD RAISED

The length of time the automatic foot lift can be held in raised position after completion of automatic stitching or completion of sewing with dip switch "2" ON, can be set to desired length of time from 5 to 30 seconds. To set the length of time, follow instructions below. (The time is set to 5 seconds when console leaves the factory)

To set the time

- (1) Turn dip switch "1" ON. (Test mode)
- (2) The following will be display on the screen when switch  for no end back tack is pressed.



- (3) The figures displayed under C and D indicate length of time in seconds the presser foot is raised.
 - ☞ The figures will increase in increments of one second at a time when switch  for no start back tack is pressed.
 - ☞ The figures will decrease in increments of one second at a time when switch  for no end back tack is pressed.
- (4) Display will be restored to initial test mode when switch  is pressed.
- (5) Turn dip switch "1" OFF.

NOTE: The foot lift can be held raised until sewing is resumed by changing the figure displayed to "00".

6. TEST MODE

Tests necessary for trouble shooting can also be done in addition to the test mode mentioned in preceding paragraphs.

1. SWITCH TEST

(1) Turn dip switch "1" ON.

(2) When switch  is pressed, the display will change as shown below and at the same time LED on all switches will light up.

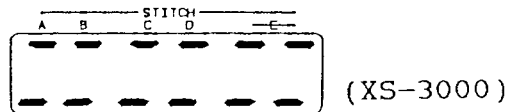
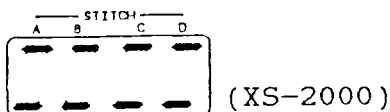

(3) First, press "+" switch. The display of switch pressed will disappear.

(4) Next, press "-" switch. The display of switch pressed will disappear. Press remaining switches and turn off all display in the same manner as above.

(5) Then press pattern switches consecutively and when LED on all pattern switches go out, press switch .

☞ If all switches are in good order, the test mode display will be restored to initial display.

* If in case there is a defective switch, turn off the main switch and repair or replace the defective switch.

2. PEDAL CURVE TEST

Check whether the speed data output from the console correspond with the speed of motor.

(1) Turn dip switch "1" ON.

(2) When switch  is pressed, the display will change as shown below.

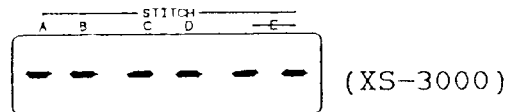
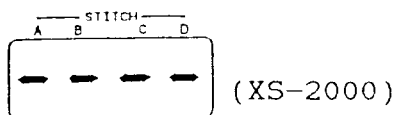

(3) When switch  is pressed once more, the display will change as shown below and the motor will start rotating.

CAUTION: Before pressing the switch, make sure it is safe to run the motor because it will start to rotate immediately when switch is pressed.



☞ The speed of the motor is displayed on the screen under A - D and is approximately 500 - 600 RPM when in normal condition.

* If in case the speed is lower, or higher than above, adjust speed to 500 - 600 RPM by turning the volume on the control box, as required.

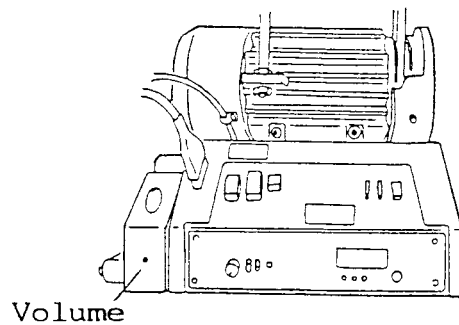



Fig.12

(4) Press switch  and restore display to initial test mode. The motor will stop when display is restored to initial test mode.

7. TROUBLE SHOOTING

Whenever sewing difficulty is encountered, check functions of the console making reference to the following table. If adjustment can not be made, call your local dealer for repair.

Condition	Cause	Correction
When display does not appear on the screen or when LED does not light up	Check power supply source voltage	Check wiring
	Cable connections	Connect connectors properly
Display flashes on and off when switch is turned on	Pedal voltage	Adjust pedal voltage
	Installation condition of pedal	Install pedal in correct position
LED and display do not react even when switches on console is pressed	There are switches that can not be used depending on sewing pattern	Change to other sewing pattern or test switch as per the test mode
Motor does not rotate even when pedal is depressed	Stitch count setting	Set switch count correctly
	Trouble in motor or control box	Check in accordance with instructions on motor
Does not rotate at high speed	Heavy machine torque	Adjust machine
	Speed control knob	Turn knob clockwise
	Matching of pedal curve	Adjust pedal curve
Does not stop even when pedal is returned to its neutral position	Pedal voltage	Adjust pedal voltage
	Trouble in motor or control box	Check in accordance with instruction on motor
Thread trimmer does not function when pedal is heeled back	Pedal voltage	Adjust pedal voltage
	Connector loosened or disconnected	Connect connectors properly
	Trouble in machine or motor	Check in accordance with the service manual
Does not back tack	Improper selection of back tack pattern	Set back tack pattern correctly
	Connector loosened or disconnected	Connect connectors properly
	Trouble in machine or motor	Check in accordance with the service manual

8. PARTS LIST AND CHART

XS-1000

No.	P/N	DESCRIPTION
1	369037-001	Console Complete
2	369038-001	Console Ass'y
3	369039-001	Console (Body)
4	369040-001	P.C. Board Complete
5	544220-003	P.C. Board Complete Set Screw
6	544212-002	Console Ass'y Set Screw (4)
7	369041-001	Rubber Cap (2)

XS-2000

No.	P/N	DESCRIPTION
1	369042-002	Console Complete
7	369045-002	Console Ass'y
8	369046-001	Console Body And Panel Ass'y
9	369050-002	P.C. Board And Cable Ass'y
10	369049-001	LED Board Complete
12	369052-002	Display Board Complete
13	369063-001	CPU Board Complete
19	369064-001	I/O Board Complete

XS-3000

No.	P/N	DESCRIPTION
1	369054-002	Console Complete
7	369055-002	Console Ass'y
8	369056-001	Console Body And Panel Ass'y
9	369050-020	P.C. Board And Cable Ass'y
10	369049-010	LED Board Complete
12	369052-020	Display Board Complete
13	369063-010	CPU Board Complete
19	369064-010	I/O Board Complete

XS-2000/3000 Common Parts

No.	P/N	DESCRIPTION
2	369043	Console Ass'y Mounting Bracket
3	544212-001	Console Ass'y Mounting Bracket Set Screw
4	544212-011	Console Ass'y Set Screw (4)
5	543804-003	Console Ass'y Set Screw Washer (4)
6	369044	Console Ass'y Set Screw Collar (4)
11	544251	LED Board Complete Set Screw (3)
14	544220-003	I/O Board Complete Set Screw (3)
15	369060-002	Cable Complete
16	369053-002	Base Plate
17	544223-001	Base Plate Set Screw (4)
18	369061	Rubber Cap

XS-1000

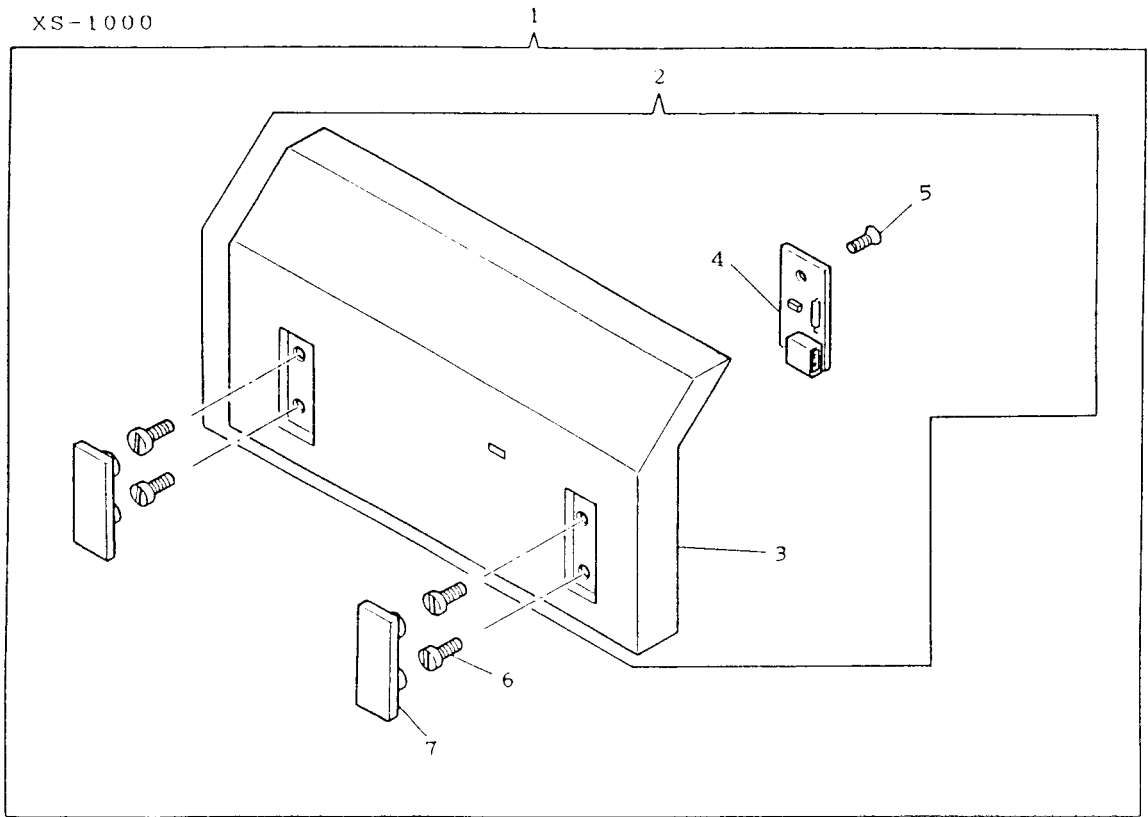

XS-2000/3000

