



Union Special
INDUSTRIAL SEWING EQUIPMENT

STYLES

**ADJUSTING INSTRUCTIONS AND
ILLUSTRATED PARTS LIST**

38200

CLASS 38200 SAMSON MACHINES

**CATALOG
NO.91L**

**SECOND
EDITION**

SECOND EDITION
© 1942

PRINTED 1996 IN USA

INFORMATION SUBJECT TO CHANGE WITHOUT NOTICE

© UNION SPECIAL CORPORATION ALL RIGHTS RESERVED IN ALL COUNTRIES.

FOREWORD

The Class 38200, or SAMSON machine, is built to the same high standard of quality that distinguishes all UNION SPECIAL machines. It is designed to fill the requirements of manufacturers of tents, awnings, covers, tarpaulins, balloon and dirigible envelopes, and other products made from canvas and treated fabrics.

The outstanding feature of the SAMSON is that it has 40 inches of underarm space which eliminates the necessity of folding or rolling wide sections of material in order to force them under the arm. In addition to the underarm space, a puller, located in back of the needles, and on some styles of machines, a second auxiliary puller, located 24 inches to the right of the needles, make it possible for heavy, bulky and wide materials to be handled with ease.

These machines can be used with one, two or three needles; equal space as three needle machines, and with either wide or narrow space when only two needles are used.

In the preparation of this parts catalog, an endeavor has been made to present the material in a simple, concise, and understandable manner so that the information desired can be readily found. It has been our constant aim to furnish carefully prepared information that will enable the customer to secure all the possible advantages and economies through the use of UNION SPECIAL machines. On the pages which follow will be found illustrations and descriptions of the parts for styles in Class 38200.

Additional catalogs, containing information relative to these machines, and which will be furnished on request, are listed below:

Catalog No. 45 N
Form 357

Needle Catalog
Engineering Department
Adjusting Instructions.
Specify the style of
machine for which the
Adjusting Instructions
are required.

In all manufacturing centers will be found Union Special representatives, who will cooperate with those who desire assistance in planning and estimating their requirements.

UNION SPECIAL CORPORATION

Engineering Department

IDENTIFICATION OF MACHINES

Each UNION SPECIAL machine carries a style number which is stamped in the name plate on the machine. Style numbers are classified as standard and special. Those which are standard have one or more letters suffixed, but never contain the letter "Z". Example 38200 C. Style numbers containing the letter "Z" are special. When only minor changes are made in a standard machine a "Z" is merely suffixed to the respective standard style number, Example: 38200 CZ.

Styles of machines similar in construction are grouped under a class number which differs from the style numbers in that it contains no letters. Example: 38200.

The distance between the adjoining rows of stitches, or one half the overall measurement, is represented by a gauge number measured in 64ths of an inch, viz: No. 13 gauge represents 13/64 inch, No. 24 gauge represents 24/64 inch, or 3/8 inch.

APPLICATION OF CATALOG

This catalog applies only to the standard styles of machines as listed herein. It can also be applied with discretion to the special machines covered by these classes.

STYLES OF MACHINES IN CLASS 38200

- 38200 C For seaming tents, awnings, covers, and similar articles; high throw for 1/2 inch height of lay, seam spec. 401-LSa-3, three needles, three loopers, left needle in front, 3/16 inch space between needles in line with feed, single built-in puller, directly behind the needles, stitch range 8 to 4 per inch, standard gauges Nos. 13 and 24.
- * 38200 D Same as 38200 C, except it is equipped with dual built-in pullers, one directly behind the needles and the other 24 inches to the right thereof.
- * 38200 E For seaming tents, awnings, covers, and similar articles; low throw for 1/4 inch maximum height of lay, seam spec. 401-LSa-3, three needles, three loopers, left needle in front, 3/16 inch space between needles in line with feed, single built-in puller directly behind the needle, stitch range 8 to 4 per inch, standard gauges Nos. 13 and 24.
- * 38200 F Same as 38200 E, except it is equipped with dual built-in pullers, one directly behind the needles and the other 24 inches to the right thereof.
- 38200 Z A special style similar to the standard styles in Class 38200, but differing in one or more of its component parts.
- * DISCONTINUED - In most instances, component parts can be ordered for customer repair.

NEEDLES

TYPE NUMBERS AND SIZES

Each needle has a type number and size number. The former denotes the kind of shank, point, length, groove, finish, and other details. The latter denotes the largest diameter of the blade, measured in thousandths of an inch midway between the shank and eye, and is stamped in the needle shank. Collectively, the type number and size number is the complete symbol.

To have orders promptly and accurately filled, the empty package, a sample needle, or the type and size numbers should be given. Use description on label. A complete order would read as follows: "1000 Needles Type 174 G Size 170/067". The type number of the needles most commonly used in the styles of machines covered by this catalog is listed below, with the description and sizes available.

Type No.	Description
174 G	Round shank, round point, antaeus, double groove, ball eye, short spot, chromium plated-sizes 170/067, 200/080, 230/090

ORDERING REPAIR PARTS

PLATES

Illustrations of parts similar in appearance, and, to some extent, component parts of the same subdivision of the mechanism, are grouped according to scale.

When a part is made in two or more sizes, usually only one illustration is shown. In ordering these parts, the additional information requested under these illustrations such as, "specify length" or "specify size", must be furnished.

LIST OF PARTS

The list of parts describes each part and its principal uses. Always check the symbol against its description before ordering. It is not necessary to furnish the plate number.

When a part is used, or can be used, in all machines covered by this catalog, no specific use is mentioned in the description.

For convenience in ordering, minor parts such as screws, nuts, and similar articles are repeated after each major part.

(-) A dash in the "plate number" column of the list of parts denotes the absence of an illustration.

(‡) A double dagger in the "symbol to order by" column denotes that the component parts cannot be furnished separately. Due to the high speed of these machines it is impossible for these associated parts to be fitted a second time and make a serviceable job.

IDENTIFYING PARTS

Where the construction permits, each part is stamped with its part number. Some of the smaller parts are stamped with an identification letter to distinguish them from parts similar in appearance.

All part numbers represent the same part, regardless of the catalog in which they appear.

SUPPLIES

All supplies, including taps, reamers, belting, belt hooks, belt fasteners, screw drivers, wrenches and powdered oil stone will be promptly furnished.

USE GENUINE NEEDLES AND REPAIR PARTS

Success in the operation of these machines can be secured only with genuine UNION SPECIAL Needles and Repair Parts as furnished by the Union Special Corporation, its subsidiaries and authorized distributors. They are designed according to the most approved scientific principles, and are made with utmost precision. Maximum efficiency and durability are assured.

Genuine needles are packaged with labels marked *UnionSpecial*®. Genuine repair parts are stamped with the Union Special trademark, U S Emblem. Each trademark is your guarantee of the highest quality in materials and workmanship.

TERMS

Prices are net cash and subject to change without notice. All shipments are forwarded f. o. b. shipping point. Parcel Post shipments are insured unless otherwise directed. A charge is made to cover the postage and insurance.

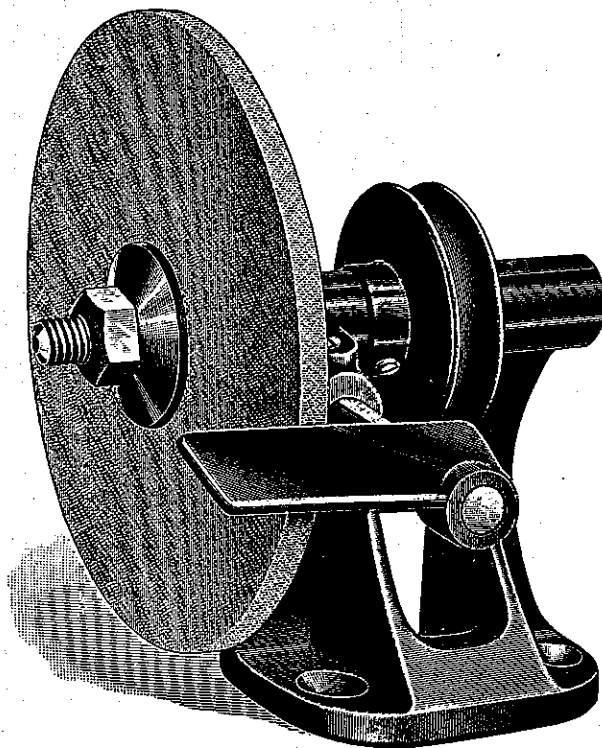

21394

Utility Grinder

PLATE 1

Full Size

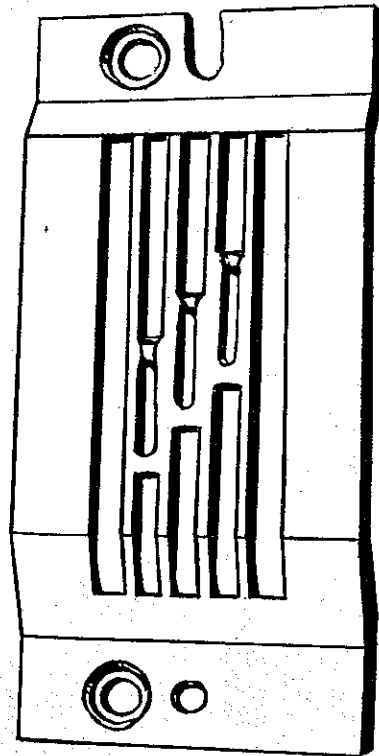

38224B-13

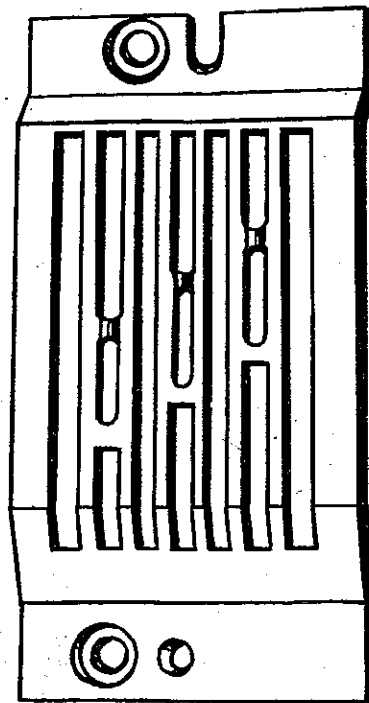

38224A-24

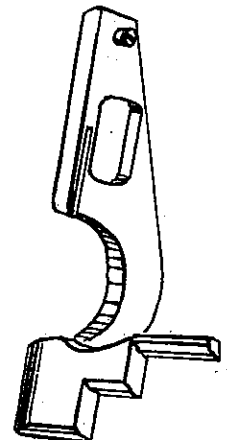

38225

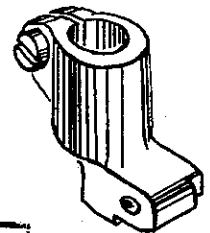

38230

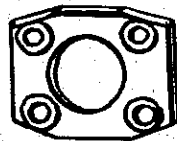

38245J
Specify
Gauge

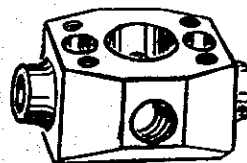

38218C
Specify
Gauge

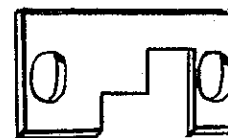

38230S

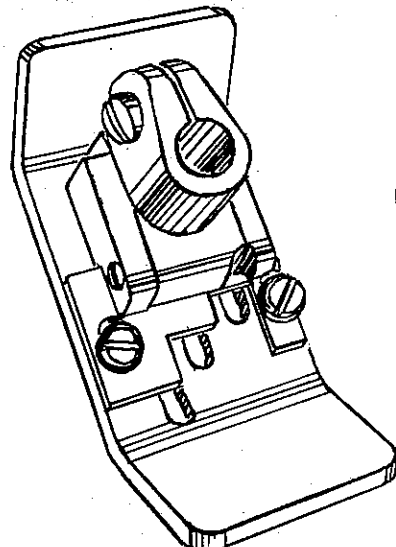

38220B-13

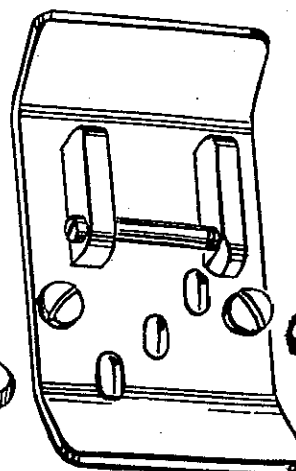

38230B-13

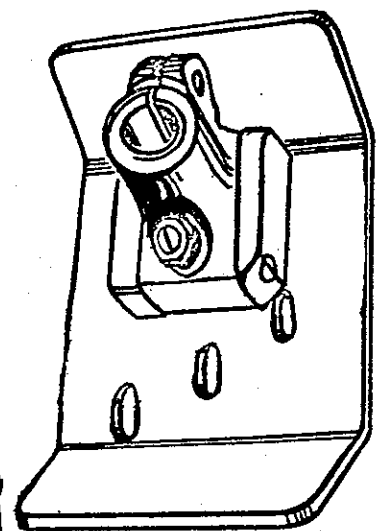

17120 B-24
Specify
Gauge

PLATE 2

Full Size

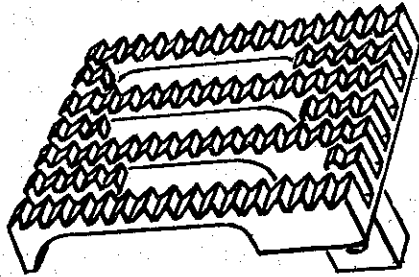

38205A
Specify
Gauge

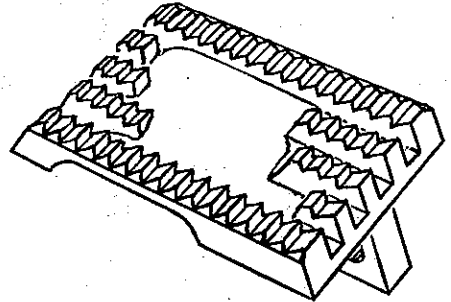

38205B-13

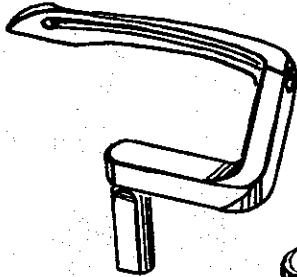

38209C

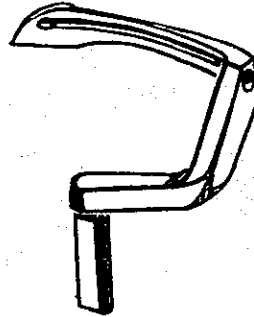

38209D
Specify
Gauge

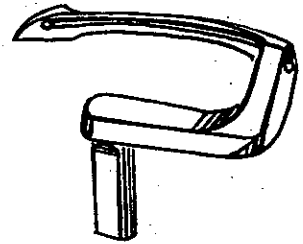

38208D
Specify
Gauge



668-27



21114 M

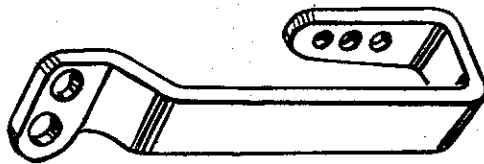

38259H

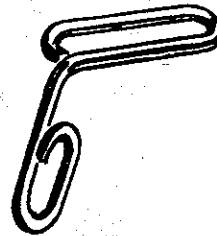

38259G

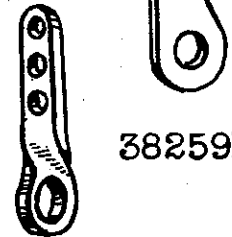

38259F

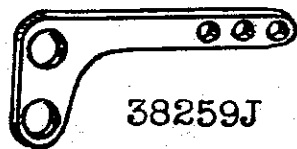

38259J



16164

38259E

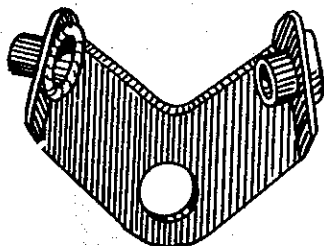

51192G

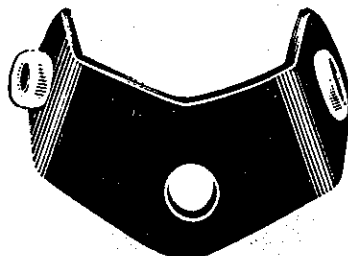

51192A

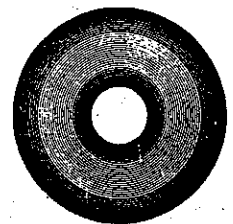

109

PLATE 3

Full Size

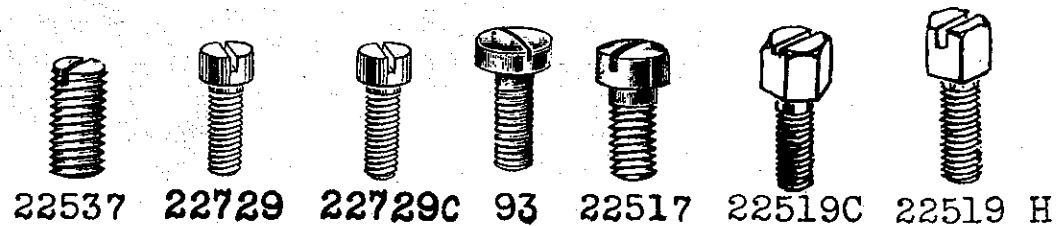
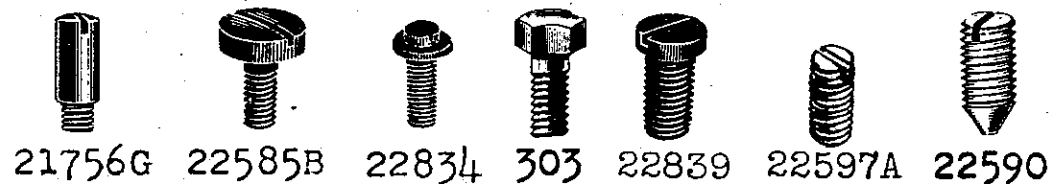
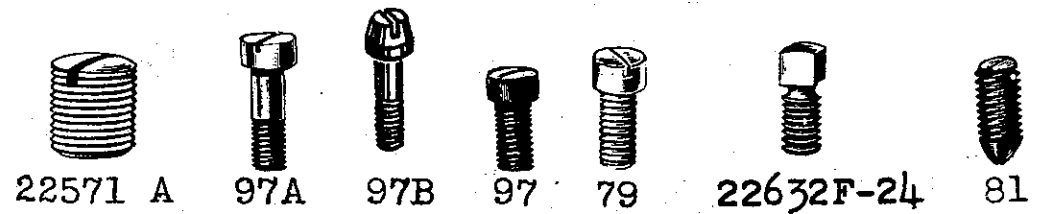
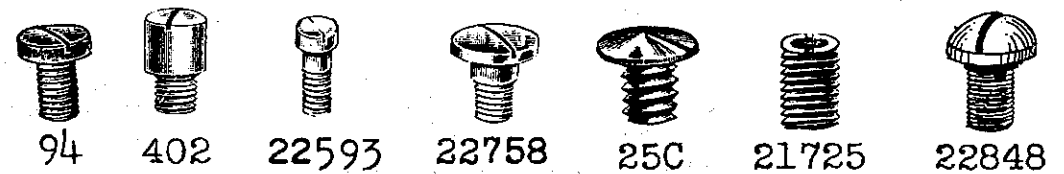
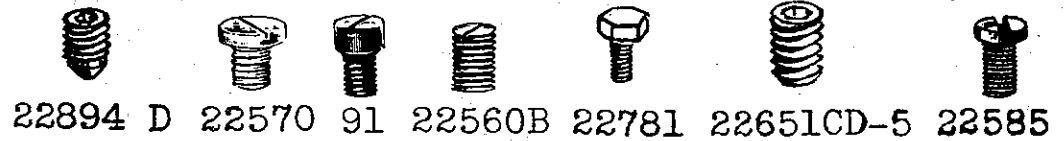
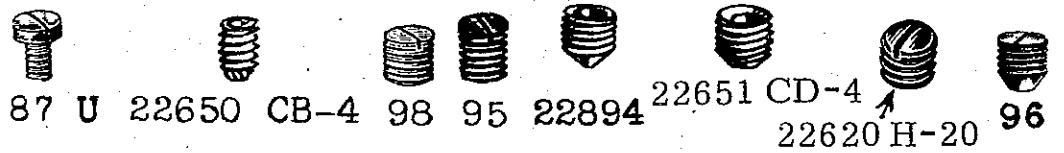
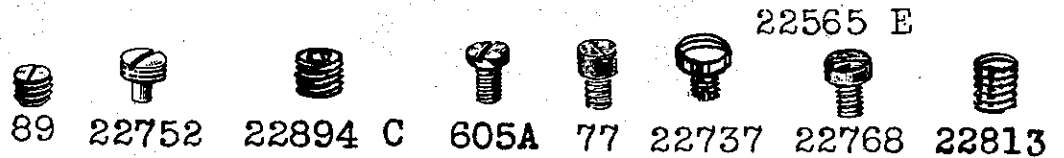

PLATE 4

Full Size

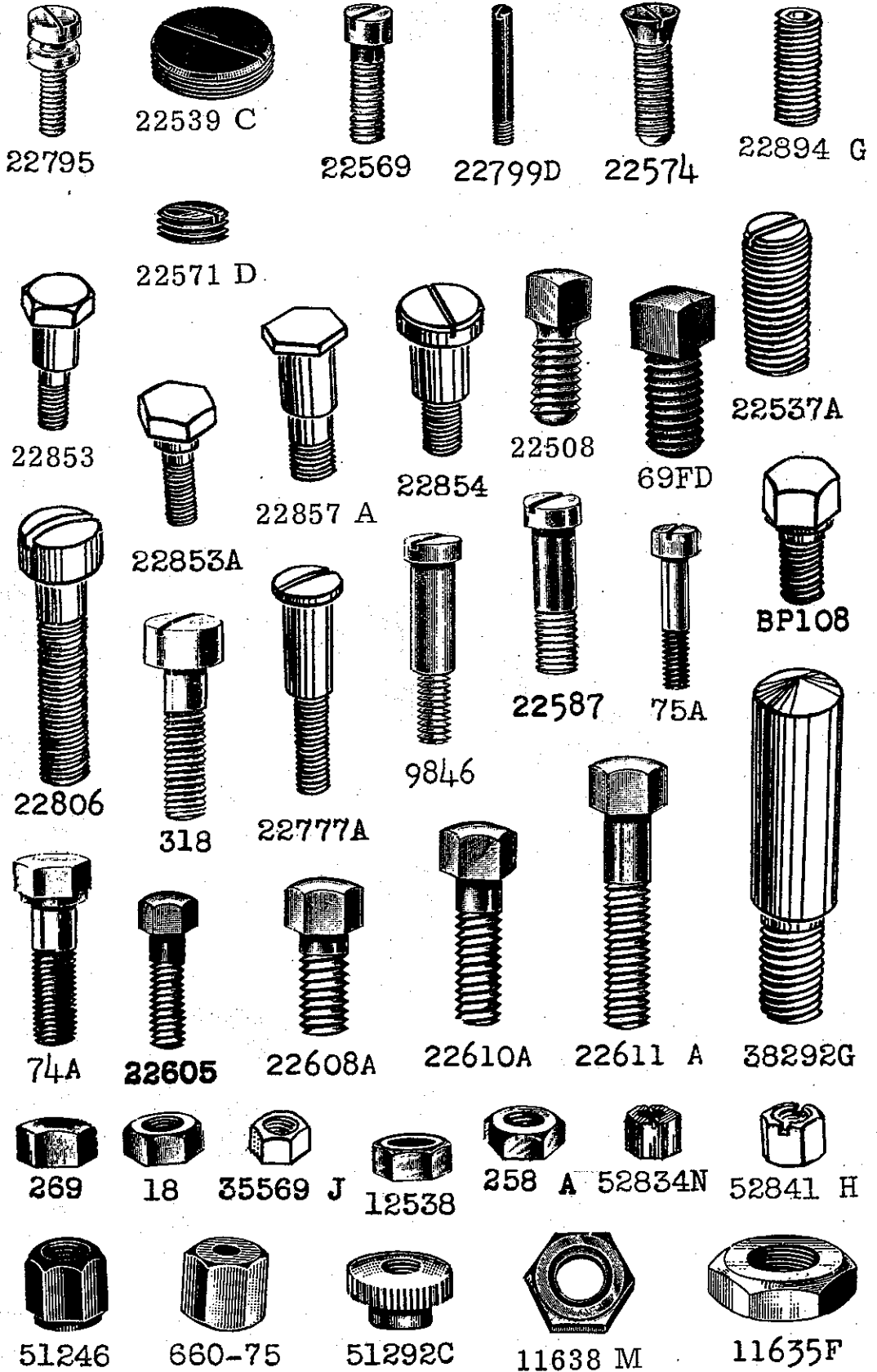
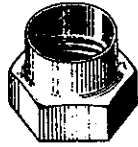

PLATE 5

Full Size



15430C



15430D

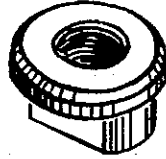

38241U

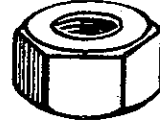

65L-20

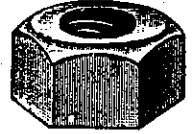

11698L



21369A



51430 F



28619



660-74



21211



61341J



51242M



20



51235G

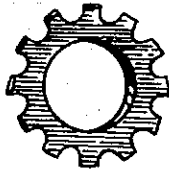

652B

Specify Minor
Symbol



61256G



39236A



8372 A



36G

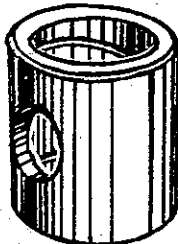

51290D

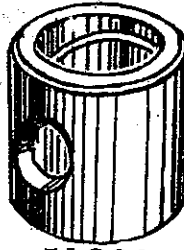

51290



35141B

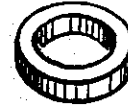

38251W



23144

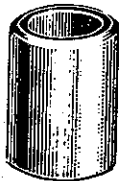

51242 C

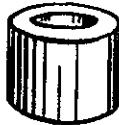

38241G

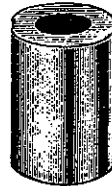

16

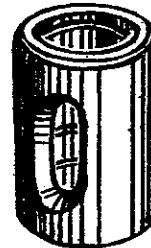

51244E

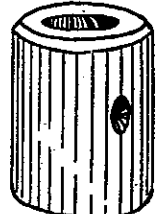

51242 B



38245F



38245E

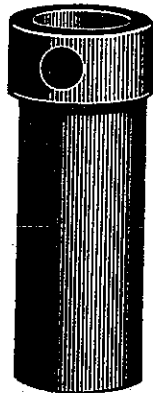

51244C

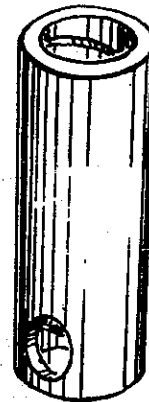

38251N



38247G

PLATE 6

Full Size



21.



21718B



52841 G



51236A



667 D-24

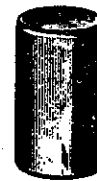

21719B



51240 D



51292

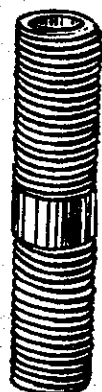

38239G

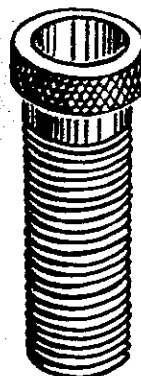

38251M

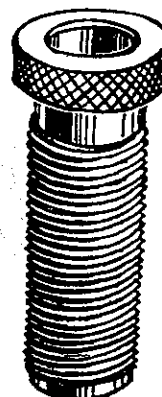

61257G



667G-40

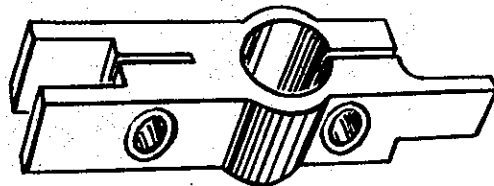

38251R



660-30

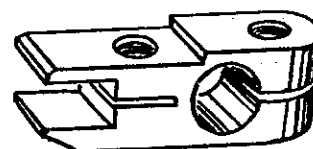

38247R

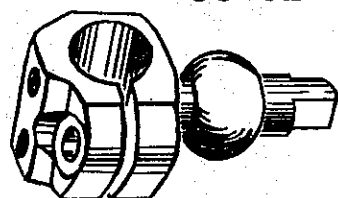

38245L

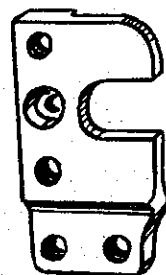

38245P

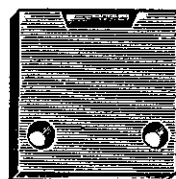

21713E



38245Q



38245T



38245S

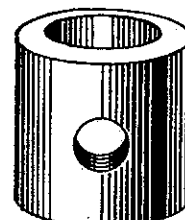

43C

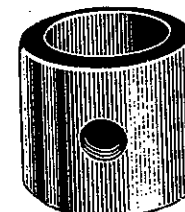

51142

PLATE 7

Full and One-half Size

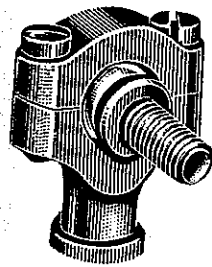

51241D

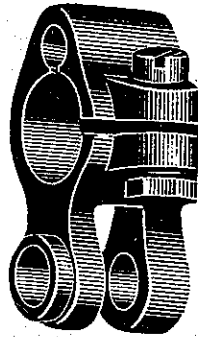

51236

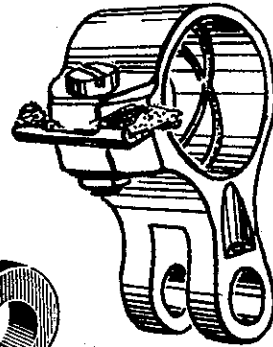

51245



51243C

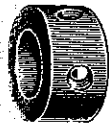

21705

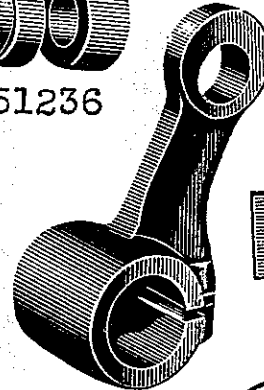

51244B



51236B



666-13

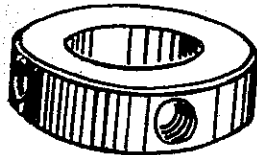

38238N

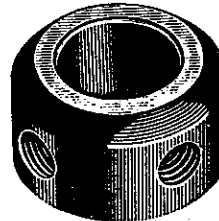

38263



2339 F



666-20

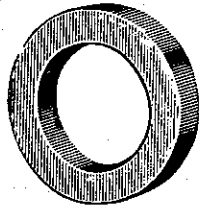

16642



21712

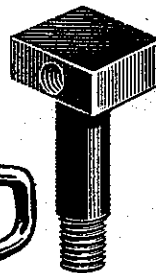

51236 C

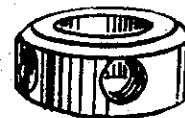

33138C

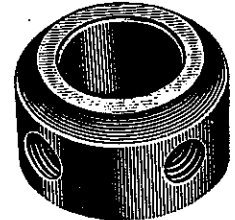

51147

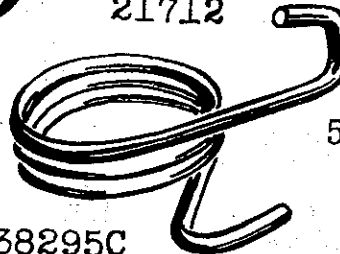

38295C

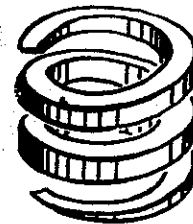

38297



38251L



21718A

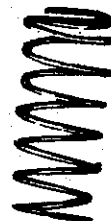

51292F-2

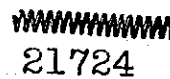

21724



110-4



110A



38247D

PLATE 8

Full and One-half Size

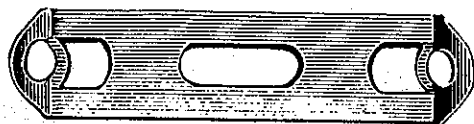

51243 E



660-90



21113B



1248



38257W

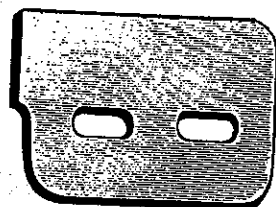

23167B



51245 A

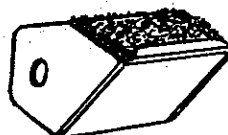

21396AS

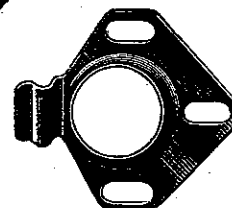

51281F



21396AG

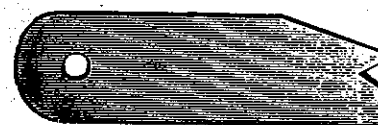

21225
Specify
Measurement

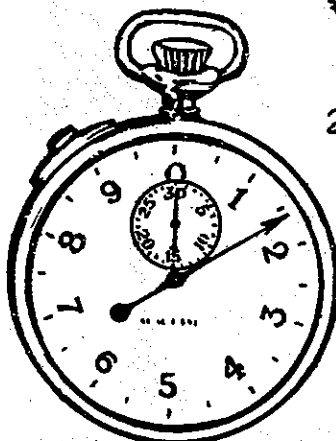

WA15 A



21396AL



21396AP

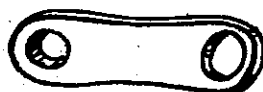

21396BG



21396AN

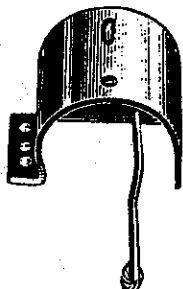

52743F



666-15



666-48

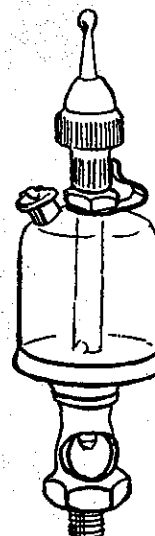

666-79

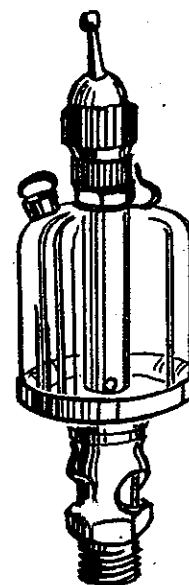

660-73

PLATE 9

One-half Size



38259B



539



38259



38270

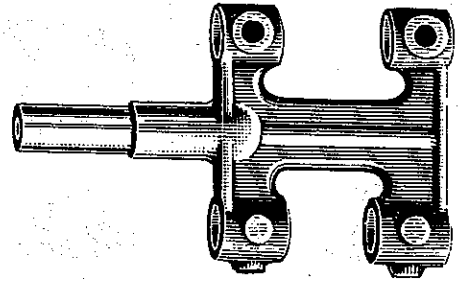

51235

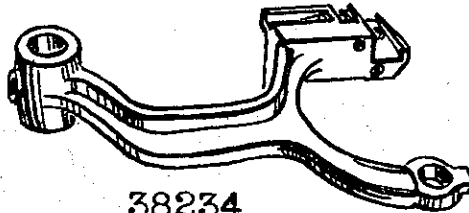

38234



38213

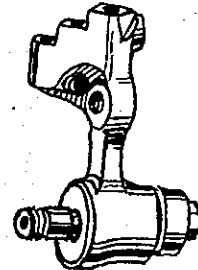

29192E

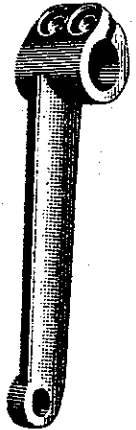

528360

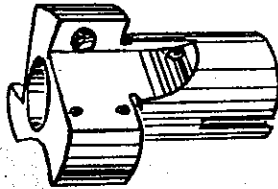

38237N

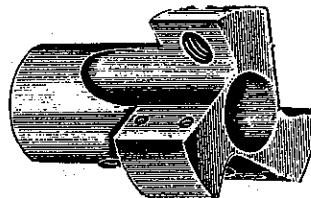

21715D

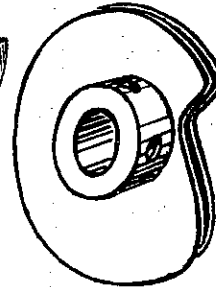

38223

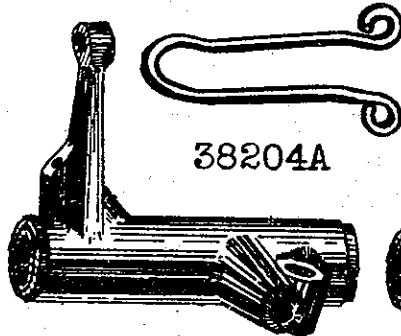

38204A

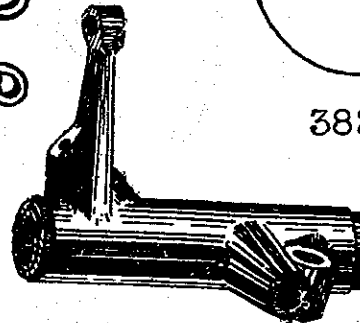

51242T

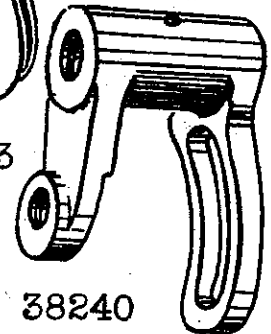

38240

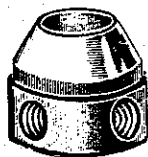

15465F

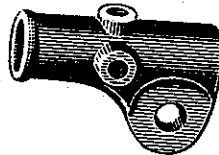

51244



38204

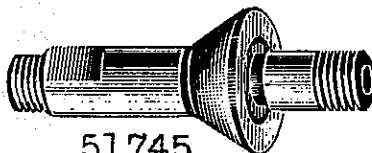

51745

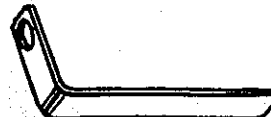

38246N

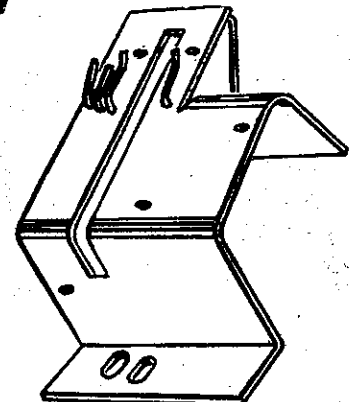

38257U

PLATE 10

One-half Size

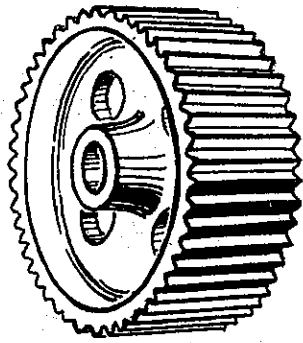

38250B



21713B

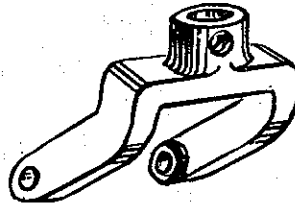

38251A

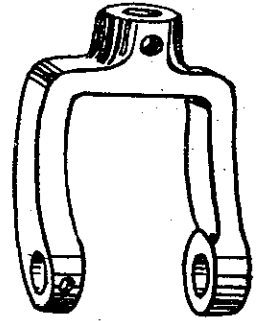

38251



21723

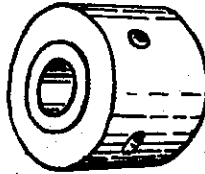

38248A

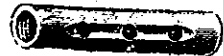

21723A

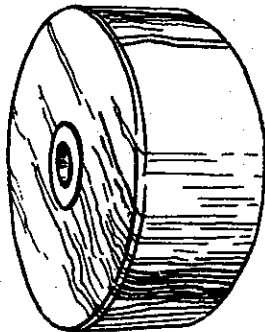

38250A



38242N

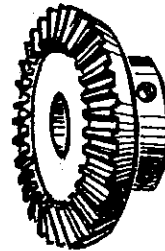

38242Q

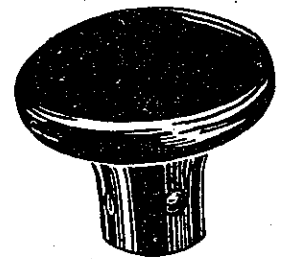

38242



38248B

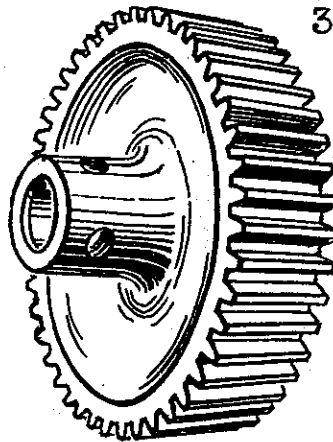

38235 B

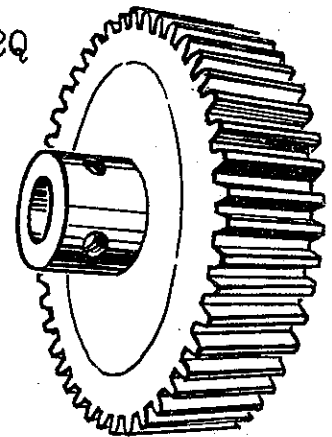

38235 E



482

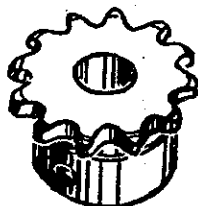

660-115

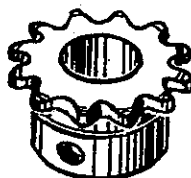

660-114

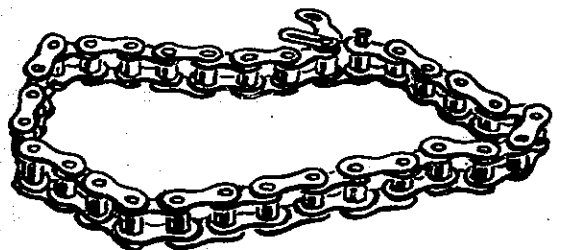

660-116

PLATE 11

One-half Size

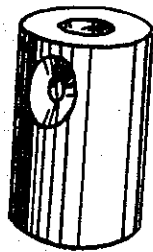

38252



38252G



38252N

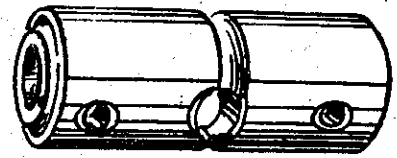

38252V



38249 51235B



38242G



39135



38295

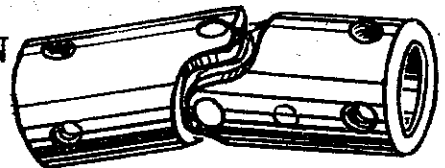

38233 L



660-99



38243



8



51244A



21113A



38299H



38251E

PLATE 12

One-half Size

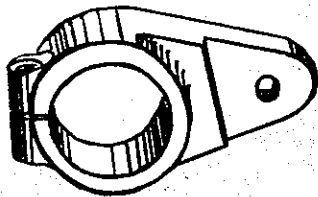

38239

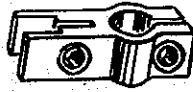

38251S



38241

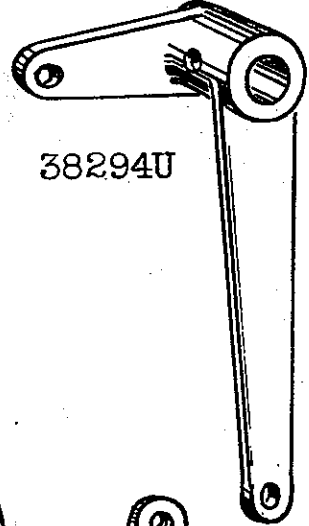

38294U

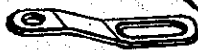

38247W

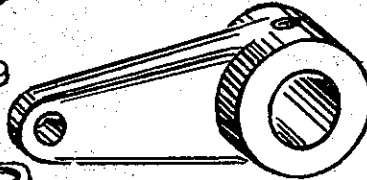

38294G

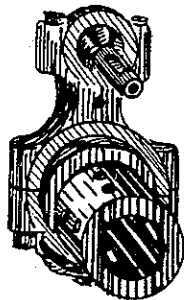

29105C

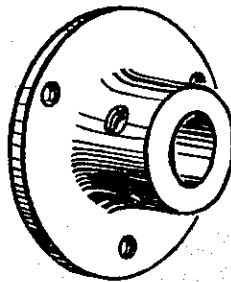

38233
38233 B

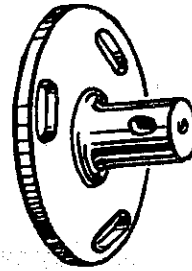

38233 A
38233 C

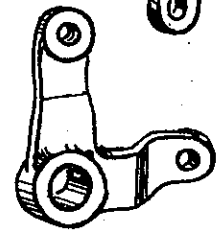

38247T



29105 B

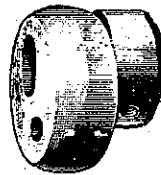

21703

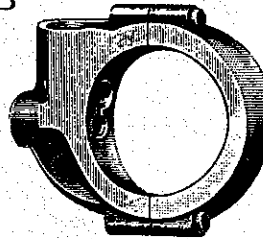

21707

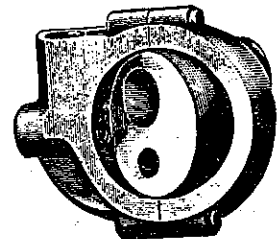

29138F



21710

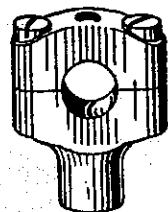

15430E



38245A

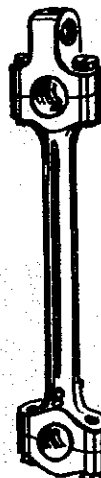

38245

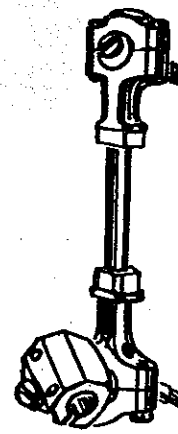

38245B



38245D

PLATE 13

One-half Size

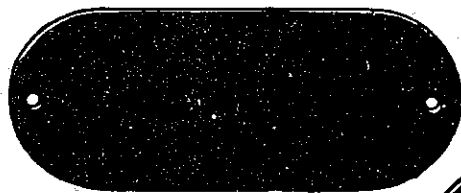

38254

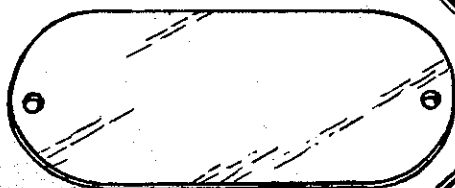

38254R

38254G

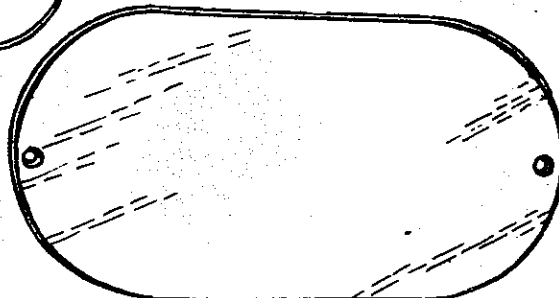

38253

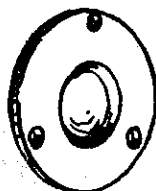

38254P

38254S



38254Q

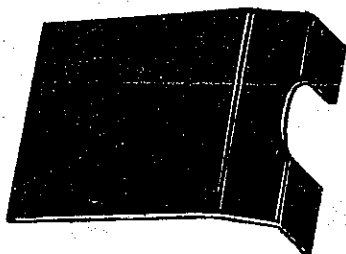

38250G

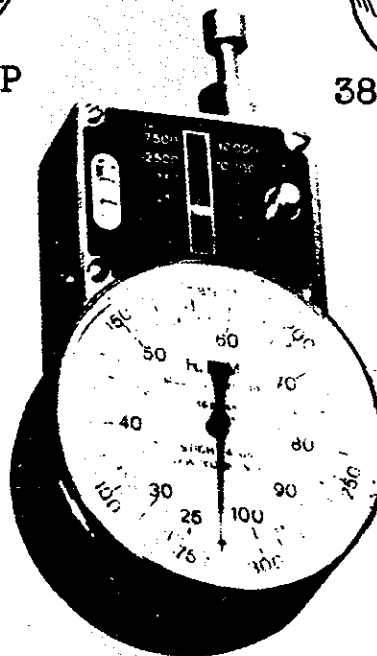

TA 55

PLATE 14
One-half Size

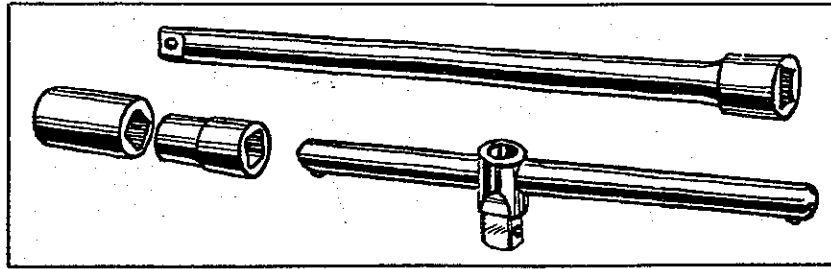

21388AE

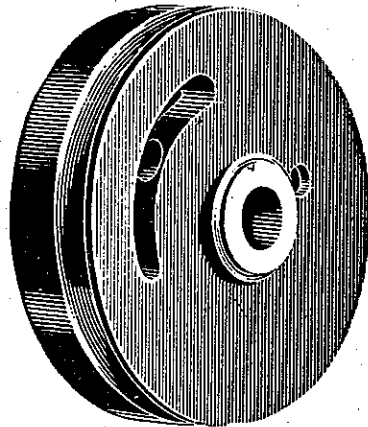

51321

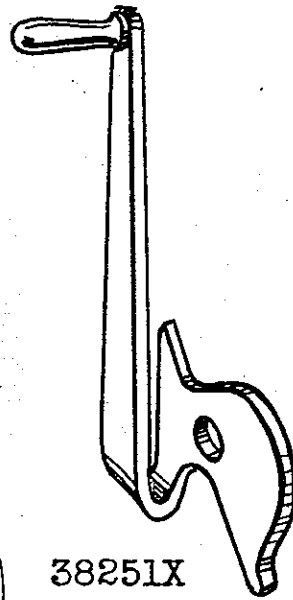

38251X

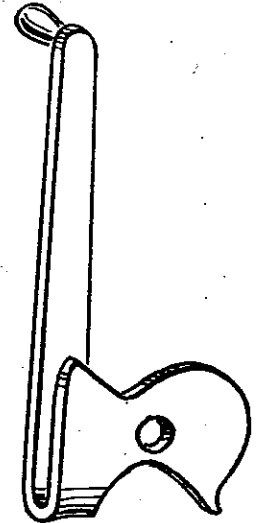

38251Y

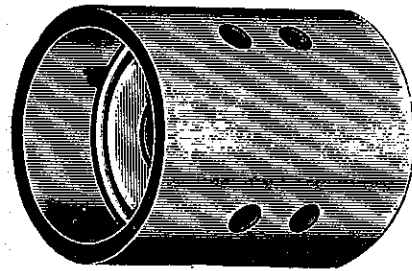

21717C

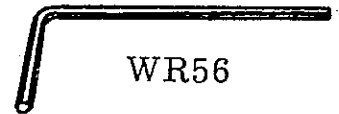

WR56

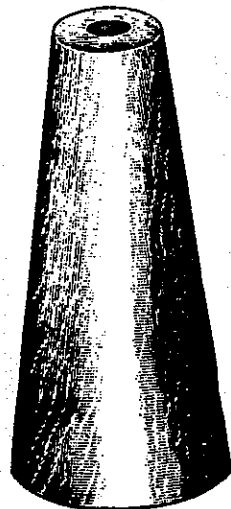

21145



21388

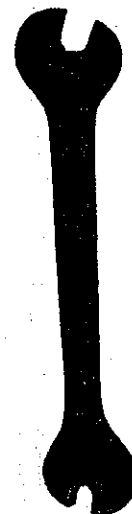

21388N

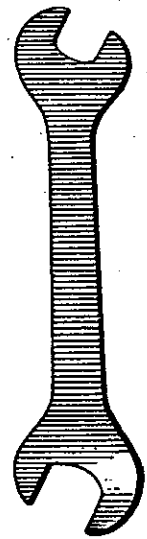

21388R

PLATE 15

Full and One-half Size

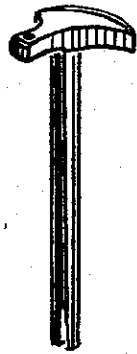

38236E



51222



38247N



38217C



38238A



38236



38238G



38249A



38236B



38222B



38247A



38222

PLATE 16

One-fourth Size



38292

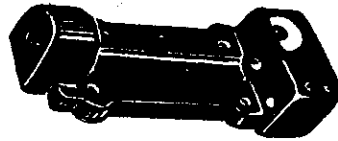

38260A

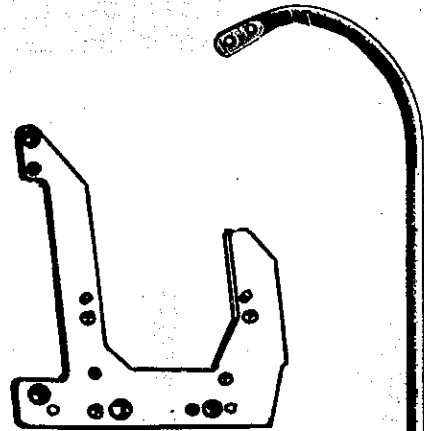

38255

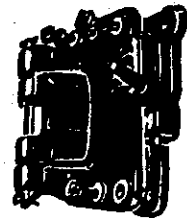

21697AA



51281
Specify
Minor
Symbol

100 B



423



424

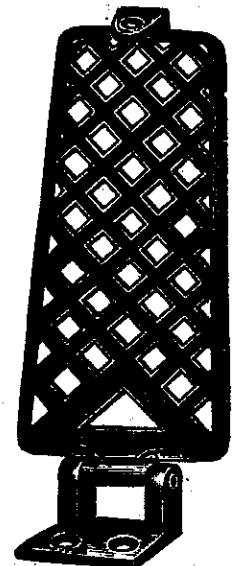

29402

PLATE 17

One-fourth Size



38297A

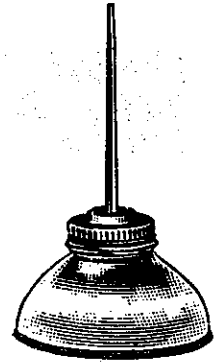

413

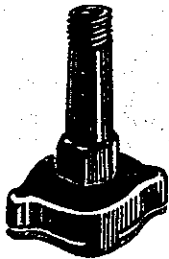

51294B

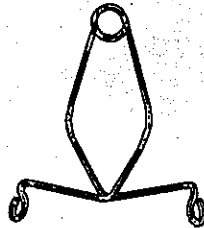

51294 A

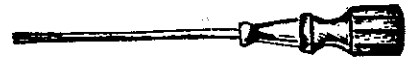

21201

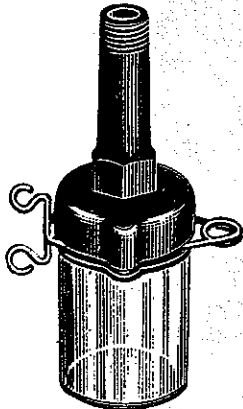

51294

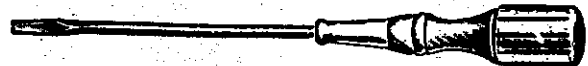

21202



21205A

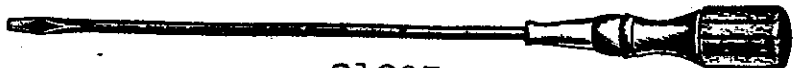

21203



666-166

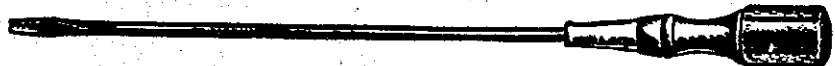

21204

PLATE 18

One-eighth Size

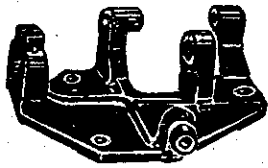

38237

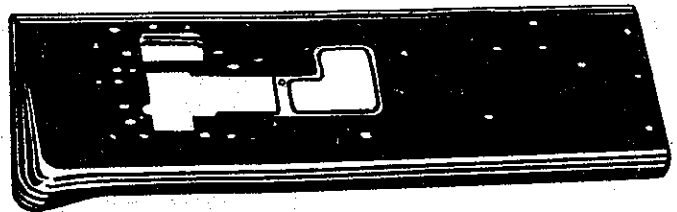

38201



38261A

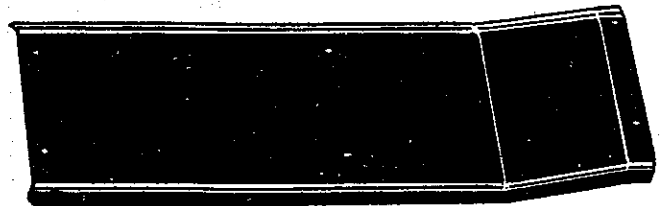

38201N



21104F

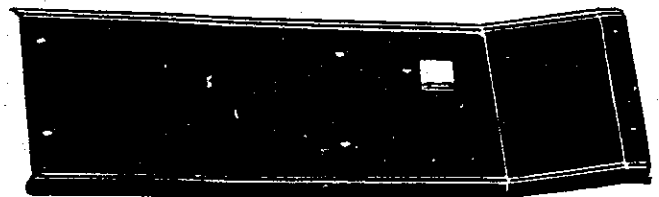

38201P



38295G



38236C



69 S

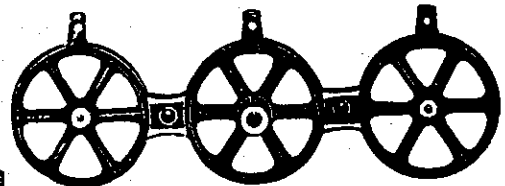

21130 A-3



38222A



21396BF

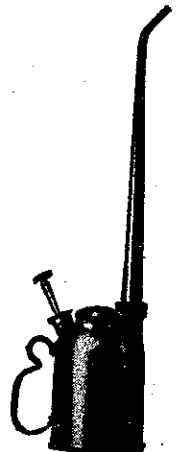

01-19

LIST OF PARTS

Symbol to Order By	The figures in the last column refer only to the plates illustrating the parts and are not to be used in ordering. Prices furnished on request.	Plate No.
8	Clutch Rocker Shaft -----	11
PL8 1/2	1/2 inch Pipe Plug -----	--
WA15 A	Stop Watch -----	8
16	Feed Crank Link Ferrule -----	5
18	Looper Connecting Rod Nut, right thread; also for Nos. 38245 A, 51241 D -----	4
OI19	Pressure Pump Oil Can, 1 1/2 pints capacity -----	18
20	Feed Crank Link Washer; also for Nos. 539, 38259 G-	5
21	Feed Crank Link Pin (screw No. 77) -----	6
25 B	Screw, for presser foot needle guard on No. 13 gauge machines-----	3
25 C	Screw, 9/32 inch long, for cloth plate attachments---	3
28	Screw, for needle bar driving link eyelet -----	3
36 G	Washer, for looper connecting rod ball joint assembly No. 51241 J -----	5
43 C	Feed Lift and Looper Avoid Eccentric, .080 inch throw, for Styles 38200 D, 38200 E, 38200 F; also feed lift eccentric for Style 38200 C (spot screw No. 22894 D) -----	6
TA55	Hand Tachometer; range 300 to 12,000 R.P.M.-----	13
WR56	Wrench, for 1/4 inch Allen socket head set screw ---	14
69 S	Spool Pin, four inches long, for thread stand-----	18
69 FD	Screw, square head, cup point 5/16 inch diameter, 18 threads per inch, 5/8 inch long -----	4
73	Screw, for loopers -----	3
74 A	Adjusting Screw, for puller clutch rocker; also for No. 38241 -----	4
75 A	Screw, for looper rocker eccentric bearing-----	4
77	Set Screw, for feed lift link pin; also for Nos. 51244 B, 52836 C -----	3
79	Set Screw, for needle bar driving stud guides -----	3
81	Spot Screw, for puller feed rolls-----	3
87 U	Screw, for cast-off wire -----	3
88	Set Screw, for looper rocker cone; also for No. 21113 B -----	3
88 B	Set Screw, for looper rocker shaft spacing sleeves ---	3
89	Set Screw, for presser roller hanger-----	3
90	Screw, for frame thread eyelet; also for Nos. 21396 BF, 38259 H-----	3
91	Clamp Screw, 3/8 inch long, for presser feet-----	3
93	Screw, for feed dog; also for Nos. 38245 L, 38254, 38254 G -----	3
93 A	Screw, for take-up thread guard -----	3
94	Screw, for main oil reservoir -----	3
95	Set Screw, for Nos. 21713 B, 38237, 38238 N, 38242, 38248 A, 38248 B, 38248 C, 38251, 38251 A, 51147--	3
HA95	Set Screw, headless, for puller clutch housing -----	--
96	Spot Screw, for looper rocker frame; also for Nos. 660-99, 38218 C-13, 38218 C-24, 38251, 38251 A---	3
97	Screw, for feed bar -----	3

LIST OF PARTS

Symbol to Order By	The figures in the last column refer only to the plates illustrating the parts and are not to be used in ordering. Prices furnished on request.	Plate No.
97 A	Bearing Screw, for needle bar connecting rod, upper and lower front; also for Nos. 29105 B, 29105 C, 51241 J -----	3
97 B	Bearing Screw, for needle bar connecting rod, lower rear -----	3
98	Set Screw, for needles; also for Nos. 482, 660-99, 2339, 33138 C, 51235, 51244 -----	3
100 B	Thread Stand Wire, 16 inches long (set screw No. 22650 CB-4)-----	16
BP108	Screw, for needle bar drive shaft coupling on Style 38200 C-----	4
109	Tension Disc -----	2
110-4	Tension Spring, .049 inch diameter wire, for needle thread -----	7
110 A	Throw Out Spring, for knob shaft bevel gear -----	7
187 A	Screw, for lap seam guide, upper-----	3
258 A	Looper Rocker Cone Nut; also for 22857 A -----	4
269	Looper Connecting Rod Nut, left thread; also for Nos. 38245 A, 38247 N, 51236 C-----	4
303	Screw, for needle bar drive shaft coupling, on Styles 38200 D, 38200 E, 38200 F -----	3
318	Screw, for puller clutch driving arm; also for No. 38237-----	4
402	Lifter Lever Stop Pin-----	3
413	Oil Can, complete-----	17
423	Lifter Treadle Base -----	16
424	Lifter Treadle Pin (set screw No. 22813)-----	16
482	Feed Rocker Shaft Collar (screw No. 98) -----	10
539	Needle Thread Eyelet, left, 2 1/4 inches long (screw No. 22848, washer No. 20)-----	9
605 A	Screw, for puller feed clutch shoe -----	3
651-20	Nut, for presser bar lifter lever bell crank stud-----	5
652 B-24	Lock Washer, for spool stand support-----	5
660-30	Cotter Pin, for foot lifter connecting rod -----	6
660-74	Needle Thread Lubricator Oil Tube Connection Sleeve-----	5
660-75	Needle Thread Lubricator Oil Tube Connection Sleeve Coupling -----	4
660-90	Felt Wiper, for looper drive eccentric assembly ----	8
660-99	Universal Joint, for puller clutch shaft (spot screw No. 96, set screw No. 98) -----	11
660-114	Auxiliary Puller Feed Roller Driving Gear, for Styles 38200 D, 38200 F (screw No. 22816) -----	10
660-115	Auxiliary Puller Feed Roller Driven Gear, for Styles 38200 D, 38200 F (screw No. 22816) -----	10
660-116	Auxiliary Puller Feed Roller Chain, for Styles 38200 D, 38200 F -----	10
660-240	Thread Tweezers -----	--
660-310	Retaining Ring, for looper connecting rod, right-----	--

LIST OF PARTS

Symbol to Order By	The figures in the last column refer only to the plates illustrating the parts and are not to be used in ordering. Prices furnished on request.	Plate No.
666-13	Felt Wick, spring pressed, for main shaft bearings-	7
666-15	Oil Cup, for right main shaft bearings; also right needle bar driving shaft bearing -----	8
666-20	Felt Wick, for feed crank link-----	7
666-48	Oil Cup, for needle bar connecting rod assembly ---	8
666-79	Sight Feed Oiler, for oiling left needle bar drive shaft bearing -----	8
666-166	Oil Drain Reservoir, glass (retaining ring No. 666-229)-----	17
666-229	Retaining Ring, for use with oil drain reservoir----	--
667 D-24	Dowel Pin, for puller clutch bracket -----	6
667 G-40	Dowel Pin, for sewing head-----	6
668-27	Thread Eyelet Insert, for thread lead-in eyelet ----	2
1248	Feed Crank Link Shim, leather-----	8
2339 F	Auxiliary Puller Feed Roller Shaft Collar, for Styles 38200 D, 38200 F (screw No. 98)-----	7
8372 A	Washer, for needle bar drive shaft coupling, right section; for Styles 38200 D, 38200 E, 38200 F ---	5
9846	Screw, for lifter lever bell crank spring -----	4
11635 F	Nut, for driving eccentric connecting rod rear bearing assembly; also for No. 21396 BF-----	4
11638 M	Nut, for needle thread lubricator oil reservoir-----	4
11698 L	Nut, for attaching thread stand spool seat to bracket-	5
12538	Nut, for right looper connecting rod and ball joint--	4
15430 C	Puller Driving Eccentric Connecting Rod Nut, left thread -----	5
15430 D	Puller Driving Eccentric Connecting Rod Nut, right thread -----	5
‡15430 E	Puller Driving Eccentric Connecting Rod Bearing, rear (screw No. 22587)-----	12
15465 F	Looper Rocker Cone (screw No. 88, nut No. 258 A)--	9
16164	Tension Post Ferrule, length overall 13/32 inch ---	2
16642	Washer, for thread stand spool seats -----	7
17120 B-24	Presser Foot, for No. 24 gauge, three needle machines (clamp screw No. 91, adjustment screw No. 22565 E, locknut No. 51430 F) -----	1
21104 F	Spool Seat Pad-----	18
21113 A	Thread Stand Wire Extension, 6 inches long (set screw No. 22650 CB-4)-----	11
21113 B	Thread Stand Wire Coupling (screw No. 88)-----	8
21114 M	Thread Eyelet Insert Locking Ring; for thread lead-in eyelets -----	2
21130 A-3	Thread Stand Seat, 3 spools (screw No. 22650 CE-6)-	18
21145	Cone, wood, for thread stand -----	14
21201	Screwdriver, 9/64 inch round blade, length overall 7 5/8 inches-----	17
21202	Screwdriver, 7/32 inch round blade, length overall 11 1/4 inches-----	17

‡ See Page 5

LIST OF PARTS

Symbol to Order By	The figures in the last column refer only to the plates illustrating the parts and are not to be used in ordering. Prices furnished on request.	Plate No.
21203	Screwdriver, 13/64 inch round blade, length overall 15 1/2 inches-----	17
21204	Screwdriver, 9/32 inch round blade, length overall 15 inches-----	17
21205 A	Screwdriver, 3/8 inch round blade, length overall 14 inches-----	17
21211	Washer, for screw No. 22593 when attaching No. 38245 Q-----	5
21225-5/32	Looper Adjustment Gauge, 5/32 inch measurement-----	8
21225-1/4	Looper Adjustment Gauge, 1/4 inch measurement-----	8
21260	Emery Cord, 3/64 inch diameter, grade No. 120, fifty yard spool-----	--
21260 A	Emery Cord, 3/64 inch diameter, grade No. 150, fifty yard spool-----	--
21260 B	Emery Cord, 1/32 inch diameter, grade No. 180, fifty yard spool-----	--
21260 C	Emery Cord, .030 inch diameter, grade No. 200, fifty yard spool-----	--
21260 D	Emery Tape, 3/32 inch wide, grade No. 180, fifty yard spool-----	--
21260 E	Emery Cord, .018 inch diameter, grade No. 200, fifty yard spool-----	--
21262 H-450	"V" Belt, 33/64 inch outer width, 45 inches long---	--
21369 A	Wing Nut, for belt guard stud-----	5
21388	Wrench, single end, 3/8 inch opening-----	14
21388 N	Wrench, double end, 3/16 and 5/16 inch openings---	14
21388 R	Wrench, double end, 3/8 and 1/2 inch openings----	14
21388 AE	Socket Wrench Assembly, for 9/32 inch and 3/8 inch hexagonal nuts for looper lever ball stud locking stud-----	14
21394	Utility Grinder, including emery wheel, 5 inches diameter, 1/4 inch face, round belt drive, recommended speed 3000 R. P. M.-----	--
21394 G	Emery Wheel, 5 inches diameter, 1/4 inch face, 3/8 inch hole, grade "M" emery 60-----	--
21394 H	Emery Wheel, 5 inches diameter, 1/2 inch face, 3/8 inch hole, grade "M" emery 60-----	--
21394 K	Utility Grinder, including emery wheel, 5 inches diameter, 1/2 inch face, round belt drive, recommended speed 3000 R. P. M.-----	--
21396 AG	Needle Thread Lubricator Felt-----	8
21396 AL	Needle Thread Lubricator Oil Reservoir Adapter---	8
21396 AN	Needle Thread Lubricator Oil Tube Clip-----	8
21396 AP	Needle Thread Lubricator Oil Reservoir Oil Tube, 10 1/4 inches long-----	8
21396 AS	Needle Thread Lubricator Cup (screw No. 22570)---	8
21396 BF	Needle Thread Lubricator Oil Reservoir Assembly (screw No. 90)-----	18
21396 BG	Needle Thread Lubricator Oil Reservoir Bracket---	8
21697 AA	Belt Take-up and Hanger Assembly-----	16

LIST OF PARTS

Symbol to Order By	The figures in the last column refer only to the plates illustrating the parts and are not to be used in ordering. Prices furnished on request.	Plate No.
21703	Puller Driving Eccentric, 4 to 7 stitches per inch (set screw No. 22894 C) -----	12
21705	Collar, for Electro Drive operating shaft (screw No. 22894 C) -----	7
‡21707	Puller Driving Eccentric Bearing (screw No. 22587)---	12
21710	Puller Driving Eccentric Connecting Rod Rear Bearing Ball Stud (nut No. 11635 F) -----	12
21712	Puller Driving Eccentric Connecting Rod Rear Bearing Ball Stud Washer -----	7
21713 B	Puller Feed Clutch Collar; also for No. 21715 D (set screw No. 95) -----	10
21713 E	Puller Clutch Shoe; also for No. 21715 D (screw No. 605 A) -----	6
21715 D	Puller Check Clutch -----	9
21717 C	Puller Clutch Housing (screw Nos. HA95, 22590)----	14
21718 A	Puller Clutch Roller Spring -----	7
21718 B	Puller Clutch Roller Spring Pin-----	6
21719 B	Puller Clutch Roller, .375 inch diameter -----	6
21723	Puller Presser Roller Axle Assembly, for 1 1/4 inch presser rollers; includes one each Nos. 21723 A, 21724, 21725, 28619-----	10
21723 A	Puller Presser Roller Axle, 1 3/4 inches long -----	10
21724	Puller Presser Roller Axle Spring -----	7
21725	Puller Presser Roller Axle Spring Screw -----	3
21756 G	Screw Pin, 1/2 inch long, for oil drain assembly----	3
22507	Set Screw, square head, 3/8 inch long, 1/4-20 thread for Pitman complete; also for Pitman connection---	--
22508	Set Screw, square head, 1/2 inch long for Pitman lifter lever -----	4
22517	Screw, for auxiliary puller roller presser bar bracket; also Nos. 38251 R, 38251 S -----	3
22519 C	Screw, for feed rocker arm -----	3
22519 H	Clamp Screw, for looper rocker shaft arm-----	3
22537	Set Screw, for presser bar guide pin-----	3
22537 A	Screw, headless, for needle thread lubricator oil reservoir-----	4
22539 C	Plug Screw, headless, for screw driver hole for spot and set screws on needle bar drive shaft coupling, left section -----	4
22560 B	Set Screw, for feed bar -----	3
22565 E	Adjusting Screw, for presser foot on 24 gauge machines (nut No. 51430 F) -----	3
22569	Screw, for feed crank link; also for No. 38257 U, 51245 -----	4
22570	Screw, fillister head, for throat plates; also for No. 21396 AS -----	3
22571 A	Plug Screw, for main shaft wick -----	3
22571 D	Plug Screw, headless, for left needle bar drive shaft bearing -----	4

‡ See Page 5

LIST OF PARTS

Symbol to Order By	The figures in the last column refer only to the plates illustrating the parts and are not to be used in ordering. Prices furnished on request.	Plate No.
22574	Screw, 21/32 inch long, for cloth plate; also for Nos. 38201 N, 38201 P-----	4
22585	Screw, for needle thread pull-up; also for No. 38254 P-----	3
22585 B	Screw, for needle rear guard -----	3
22587	Screw, for puller driving eccentric bearing; also for No. 15430 E-----	4
22590	Spot Screw, headless, for puller clutch housing ----	3
22591	Set Screw, headless, for puller press bar guide pin; also pulley on Style 38200 C -----	3
22593	Screw, for needle bar connecting rod ball stud guide fork; also for Nos. 38245 Q, 38259 E -----	3
22597 A	Screw, for looper drive lever shaft; also for No. K56188 -----	3
22605	Cap Screw, 1 1/4 inches long, for puller clutch bracket-----	4
22608 A	Cap Screw, 1 1/4 inches long, for attaching bed to portable stand-----	4
22610 A	Cap Screw, 1 3/4 inches long, for attaching bed to portable stand-----	4
22611 A	Cap Screw, 2 1/2 inches long, for attaching sewing head to bed-----	4
* 22632 F-24	Set Screw, square head, cup point, 3/8 inch long, 3/16 inch diameter, 24 threads per inch, for manual drive main shaft bevel gear-----	3
22650 CB-4	Set Screw, headless, socket type, cup point, 1/4 inch long, 3/16 inch diameter, 24 threads per inch, for thread stand wire-----	3
22650 CE-6	Set Screw, headless, socket type, cup point, 3/8 inch long, 5/16 inch diameter, 18 threads per inch, for spool stand support seat-----	3
22651 CD-4	Set Screw, headless, for needle bar drive shaft coupling, left section, for Styles 38200 D, 38200 E, 38200 F-----	3
22651 CD-5	Set Screw, headless, for needle bar drive shaft gear, left section-----	3
22716	Screw, for needle stop plate -----	3
22726 A	Screw, for cloth plate cover spring-----	3
22729	Screw, for looper drive lever ball stud guide fork --	3
22729 C	Bearing Screw, for No. 51241 D-----	3
22737	Screw, for cast-off plate -----	3
22752	Set Screw, with pilot, for middle needle on three needle machines-----	3
22758	Screw, for presser bar lifter lever link -----	3
22768	Screw, for feed crank stud cap; also for No. 38250 G-----	3
22777 A	Lifter Lever Stud, for Styles 38200 D, 38200 F ----	4
22781	Screw, for cast-off support eyelet, left -----	3
22795	Stitch Regulating Screw-----	4
22799 D	Hinge Screw, length overall 49/64 inch, diameter .124 inch, for presser foot bottom on No. 13 gauge machines -----	4

* 22620 H-20
See page 32,

LIST OF PARTS

Symbol to Order By	The figures in the last column refer only to the plates illustrating the parts and are not to be used in ordering. Prices furnished on request.	Plate No.
22801	Stop Screw, for stitch regulating screw; also No. 38225-	3
22806	Screw, for auxiliary puller roll shaft bearing bracket-	4
22813	Set Screw, for knob shaft bevel gear; also No. 424---	3
* 22620 H-20	Set Screw, for auxiliary puller feed roller driving gear on Styles 38200 D, 38200 F; also No. 660-115 -----	3
22829	Locking Screw, for looper rocker cone nut -----	3
22834	Screw, for regulating needle rear guard -----	3
22839	Screw, fillister head, for throat plate support -----	3
22848	Screw, for face plate; also Nos. 539, 38259 G-----	3
22853	Screw, for presser bar lifter arm, right -----	4
22853 A	Screw, for presser bar lifter arm, left-----	4
22854	Screw, for puller presser roller lifter lever -----	4
22857 A	Screw, for presser bar lifter lever -----	4
22894	Spot Screw, for Nos. 660-100, 38233-----	3
22894 C	Set Screw, for looper drive eccentric assembly; also Nos. 21705, 29138 F, 38223-----	3
22894 D	Spot Screw, for looper drive eccentric assembly; also Nos. 43 C, -51142-----	3
22894 F	Set Screw, headless, for upper needle bar drive shaft and main shaft; also for Nos. 38233 B, 38235 B, 38235 E, 38263 -----	3
22894 G	Set Screw, headless, for pulley on Styles 38200 D, 38200 E, 38200 F -----	4
22894 N	Spot Screw, for upper needle bar drive shaft and main shaft; also No. 38235 D -----	--
23144	Lifter Lever Washer -----	5
23167 B	Lap Seam Guide, lower (screw No. 25 C)-----	8
23167 AC	Guide, left, for upper lap seam guide -----	--
23167 AD	Lap Seam Guide, upper; one each Nos. 23167 AC, 23167 AE, two No. 187 A (screw No. 25 C) -----	--
23167 AE	Guide, right, for upper lap seam guide -----	--
28568 A	Pitman Lever-----	--
28606-1/2	Powdered Oil Stone, 1/2 lb. package -----	--
28606-1	Powdered Oil Stone, 1 lb. package -----	--
28619	Puller Presser Roller Axle Ball -----	5
‡29105 B	Looper Drive Eccentric Assembly, includes eccentric No. 51343, for Styles 38200 E, 38200 F (set screw No. 22894 C, spot screw No. 22894 D, bearing screws, upper, No. 75 A, lower No. 97 A) -----	12
‡29105 C	Looper Drive Eccentric Assembly, includes eccentric No. 52743, for Styles 38200 C, 38200 D (set screw No. 22894 C, bearing screws, upper, No. 75 A, lower, No. 97 A) -----	12
29138 F	Puller Clutch Driving Eccentric Assembly, stitch 4 to 7 per inch; one each Nos. 21703, 21707 (screw No. 22894 C) -----	12
29139	Puller Clutch Driving Connecting Rod Rear Bearing Assembly; one each Nos. 15430 E, 21710 -----	--
29192 E	Looper Rocker Assembly; one each Nos. 15465 F, 38213, 51745 lapped together, Nos. 258 A, 22829---	9
‡ See Page 5		

LIST OF PARTS

Symbol to Order By	The figures in the last column refer only to the plates illustrating the parts and are not to be used in ordering. Prices furnished on request.	Plate No.
29402	Lifter Treadle Assembly; one each Nos. 423, 424, 22813-----	16
33138 C	Puller Clutch Rocker Collar (screw No. 98) -----	7
35141 B	Washer, for puller clutch driving link-----	5
35569 J	Feed Crank Link Nut; also for No. 51245 -----	4
35853 V-156	Hinge Pin, for looper connecting rod, right-----	--
38201	Cloth Plate (screw No. 22574)-----	18
38201 N	Cloth Plate Extension, for Styles 38200 C, 38200 E (screw No. 22574) -----	18
38201 P	Cloth Plate Extension, for Styles 38200 D, 38200 F (screw No. 22574) -----	18
38204	Cast-off Plate (screw No. 22737)-----	9
38204 A	Cast-off Wire (screw No. 87 U) -----	9
38205 A-24	Feed Dog, for 24 gauge three needle machines (screw No. 93)-----	2
38205 B-13	Feed Dog, for 13 gauge three needle machines (screw No. 93)-----	2
38208 D-13	Looper, front, for 13 gauge three needle machines (set screw No. 73)-----	2
38208 D-24	Looper, front, for 24 gauge (set screw No. 73) ----	2
38209 C	Looper, middle, for three needle machines (set screw No. 73)-----	2
38209 D-13	Looper, back, for 13 gauge three needle machines (set screw No. 73)-----	2
38209 D-24	Looper, back, for No. 24 gauge (set screw No. 73)---	2
38213	Looper Rocker, marked "A"-----	9
38217 C	Needle Bar (spot screw No. 96) -----	15
38218 C-13	Needle Holder, for 13 gauge three needle machines (spot screw No. 96, needle set screw, middle, No. 22752, needle set screw, outer, No. 98) -----	1
38218 C-24	Needle Holder, for 24 gauge three needle machines (spot screw No. 96, needle set screw, middle, No. 22752, needle set screw, outer, No. 98) -----	1
38220 B-13	Presser Foot Assembly, for No. 13 gauge three needle machines; one each Nos. 22799 D, 38230, 38230 B-13, 38230 S; two No. 25 B -----	1
38221	Round Belt Pulley, for Style 38200 C (screw No. 22591)-----	--
38222	Main Shaft, left middle section, for Styles 38200 D, 38200 E, 38200 F-----	15
38222 A	Main Shaft, right middle section, for Styles 38200 D, 38200 E, 38200 F-----	18
38222 B	Main Shaft, right section, for Styles 38200 D, 38200 E, 38200 F-----	15
38222 C	Main Shaft, left middle section, for Style 38200 C --	--
38222 D	Main Shaft, right middle section, for Style 38200 C --	--
38222 E	Main Shaft, right section, for Style 38200 C -----	--
38223	Shielded Disc Take-up (set screw No. 22894 C) ----	9
38224 A-24	Throat Plate, for 24 gauge three needle machines (screw No. 22570) -----	1

LIST OF PARTS

Symbol to Order By	The figures in the last column refer only to the plates illustrating the parts and are not to be used in ordering. Prices furnished on request.	Plate No.
38224 B-13	Throat Plate, for 13 gauge three needle machines (screw No. 22570) -----	1
38225	Needle Rear Guard (screw No. 22585 B, washer No. 39236 A)-----	1
38230	Presser Foot Shank, for 13 gauge machines (clamp screw No. 91)-----	1
38230 B-13	Presser Foot Bottom, for 13 gauge machines (hinge screw No. 22799 D)-----	1
38230 S	Presser Foot Needle Guard, for 13 gauge machines (screw No. 25 B) -----	1
38233	Needle Bar Drive Shaft Coupling, left section, for Styles 38200 D, 38200 E, 38200 F (spot screw No. 22894, set screw No. 22651 CD-4)-----	12
38233 A	Needle Bar Drive Shaft Coupling, right section, for Styles 38200 D, 38200 E, 38200 F (screw No. 303, washer No. 8372 A)-----	12
38233 B	Needle Bar Drive Shaft Coupling, left section, for Style 38200 C (set screw No. 22894 F) -----	12
38233 C	Needle Bar Drive Shaft Coupling, right section, for Style 38200 C (screw No. BP108, washer No. 61341 J)-	12
38233 L	Universal Joint, for main shaft and upper needle bar drive shaft; two each set screw No. 22894 F, spot screw No. 22894 N)-----	11
38234	Feed Bar (screw Nos. 77, 97, 22560 B, 22834) ----	9
38235 B	Needle Bar Drive Shaft Driving Gear, steel (set screw No. 22894 F)-----	10
38235 E	Needle Bar Drive Shaft Driven Gear, fibroid (two set screws No. 22894 F)-----	--
38236	Needle Bar Drive Shaft, left section, for Style 38200 E, 38200 F-----	15
38236 B	Needle Bar Drive Shaft, right section, for Styles 38200 D, 38200 E, 38200 F -----	15
38236 C	Needle Bar Drive Shaft, middle section, for Styles 38200 D, 38200 E, 38200 F -----	18
38236 E	Needle Bar Drive Shaft, left section, for Styles 38200 C, 38200 D-----	15
38236 F	Needle Bar Drive Shaft, middle section, for Style 38200 C-----	--
38236 G	Needle Bar Drive Shaft, right section, for Style 38200 C-----	--
38237	Puller Clutch Bracket (screw Nos. 95, 318, 22605, dowel pin No. 667 D-24)-----	18
38237 N	Puller Feed Clutch-----	9
38238 A	Puller Clutch Shaft-----	15
38238 G	Puller Clutch Shaft Universal Joint Connecting Stud-----	15
38238 N	Puller Clutch Shaft Collar (screw No. 95) -----	7
38239	Puller Clutch Driving Arm (screw No. 318)-----	12
38239 G	Puller Driving Eccentric Connecting Rod (nut, left thread, No. 15430 C, right thread, No. 15430 D)--	6
38240	Puller Clutch Rocker-----	9

LIST OF PARTS

Symbol to Order By	The figures in the last column refer only to the plates illustrating the parts and are not to be used in ordering. Prices furnished on request.	Plate No.
38241	Puller Clutch Driving Link (screw No. 74 A)-----	12
38241 G	Puller Clutch Driving Link Bushing-----	5
38241 U	Puller Clutch Feed Regulating Slide Block-----	5
38242	Knob, for operating machine manually (screw No. 95)-----	10
38242 G	Knob Shaft -----	11
38242 N	Knob Shaft Bevel Gear (screw No. 22813)-----	10
38242 Q	Main Shaft Bevel Gear, for operating machine manually (screw No. 22632 F-24) -----	10
‡38243	Looper Lever Shaft (screw No. 22597 A) -----	11
‡38245	Needle Bar Connecting Rod (upper bearing screw No. 97 A, lower bearing screw, front, No. 97 A, rear, No. 97 B)-----	12
‡38245 A	Needle Bar Connecting Rod, for Styles 38200 C, 38200 D (upper bearing screw No. 97 A, lower bearing screw, front, No. 97 A, rear, No. 97 B; upper bearing nut No. 18, lower bearing nut No. 269)-----	12
‡38245 B	Needle Bar Connecting Rod Assembly; for Styles 38200 C, 38200 D; one each Nos. 38245 A, 38245 C, 38245 L-----	12
‡38245 D	Needle Bar Connecting Rod Assembly, for Styles 38200 E, 38200 F; one each Nos. 38245, 38245 C, 38245 L-----	12
38245 E	Needle Bar Bushing, upper -----	5
38245 F	Needle Bar Bushing, lower -----	5
38245 J-13	Needle Stop Plate, for 13 gauge three needle machines (screw No. 22716) -----	1
38245 J-24	Needle Stop Plate, for 24 gauge three needle machines (screw No. 22716) -----	1
38245 L	Needle Bar Connecting Rod Driving Stud (screw No. 93)-----	6
38245 P	Needle Bar Connecting Rod Ball Stud Guide Fork and Eyelet Support (screw No. 22593) -----	6
38245 Q	Needle Bar Connecting Rod Ball Stud Guide Fork Yoke (screw No. 22593) -----	6
38245 S	Needle Bar Connecting Rod Driving Stud Guide, front (screw No. 79) -----	6
38245 T	Needle Bar Connecting Rod Driving Stud, rear (screw No. 79)-----	6
38246 N	Looper Thread Take-up Guard (screw No. 93 A) ---	9
38247 A	Presser Bar -----	15
38247 D	Presser Bar Spring -----	7
38247 G	Presser Bar Bushing, lower -----	5
38247 N	Presser Bar Guide Pin (screw No. 22537); also puller presser bar guide pin (screw No. 22591, nut No. 258 A)-----	15
38247 R	Presser Bar Lifter Arm (screw, left, No. 22853 A; screw, right, No. 22853)-----	6
38247 T	Presser Bar Lifter Lever (screw No. 22857 A) ----	12
38247 W	Presser Bar Lifter Lever Link (screw No. 22758)---	12
‡ See Page 5		

LIST OF PARTS

Symbol to Order By	The figures in the last column refer only to the plates illustrating the parts and are not to be used in ordering. Prices furnished on request.	Plate No.
38248 A	Puller Feed Roller, rubber, 1 1/4 inches long, for Styles 38200 D, 38200 F (set screw No. 95, spot screw No. 81) -----	10
38248 B	Puller Feed Roller, steel, 2 1/4 inches long, 22 teeth, for Styles 38200 D, 38200 E, 38200 F (set screw No. 95, spot screw No. 81) -----	10
38248 C	Puller Feed Roller, steel, 2 1/4 inches long, 11 teeth, for Style 38200 C (set screw No. 95, spot screw No. 81) -----	--
38249	Puller Feed Roller Shaft -----	11
38249 A	Auxiliary Puller Feed Roller Shaft, for Styles 38200 D, 38200 F -----	15
38250 A	Puller Presser Roller, wood, 1 1/4 inches long, for Styles 38200 D, 38200 F -----	10
38250 B	Puller Presser Roller, steel, 1 1/4 inches long, 47 teeth, for Styles 38200 D, 38200 E, 38200 F -----	10
38250 C	Puller Presser Roller, steel, 1 1/3 inches long, 25 teeth, for Style 38200 C -----	--
38250 G	Auxiliary Puller Presser Roller Guard, for Styles 38200 D, 38200 F (screw No. 22768) -----	13
38251	Puller Presser Roller Hanger (spot screw No. 96, set screw for shank No. 95; set screw for right hand prong No. 89)-----	10
38251 A	Auxiliary Puller Presser Roller Hanger, for Styles 38200 D, 38200 F (spot screw No. 96, set screw for shank No. 95; set screw for right hand prong No. 89)-----	10
38251 E	Puller Roller Presser Bar -----	11
38251 L	Puller Roller Presser Bar Spring-----	7
38251 M	Puller Roller Presser Bar Bushing and Spring Regulator, upper-----	6
38251 N	Puller Roller Presser Bar Bushing, lower-----	5
38251 R	Puller Roller Presser Bar Lifter Arm (screw No. 22517) -----	6
38251 S	Auxiliary Puller Roller Presser Bar Lifter Arm, for Styles 38200 D, 38200 F (screw No. 22517)-----	12
38251 W	Lifter Lever Stud Collar -----	5
38251 X	Auxiliary Puller Roller Presser Bar Lifter Lever, for Styles 38200 D, 38200 F (shoulder screw No. 22854, spring washer No. 23144, collar No. 38251 W)-----	14
38251 Y	Puller Roller Presser Bar Lifter Lever, left (screw No. 22854) -----	14
38252	Needle Bar Drive Shaft Bushing, right-----	11
38252 G	Main Shaft Bushing, middle and middle right; also needle bar drive shaft bushing, middle -----	11
38252 N	Main Size Bushing, right-----	11
38252 V	Needle Bar Drive Shaft Bushing, left -----	11
38253	Face Plate (screw No. 22848) -----	13
38254	Needle Bar Drive Shaft Gear Chamber Cover, upper; also needle bar drive shaft universal joint opening cover (screw No. 93) -----	13

LIST OF PARTS

Symbol to Order By	The figures in the last column refer only to the plates illustrating the parts and are not to be used in ordering. Prices furnished on request.	Plate No.
38254 G	Needle Bar Drive Shaft Gear Chamber Cover, rear (screw No. 93) -----	13
38254 F	Needle Bar Drive Shaft Chamber Cover, right (screw No. 22585)-----	13
38254 Q	Needle Bar Drive Shaft Chamber Cover Gasket, right-	13
38254 R	Needle Bar Drive Shaft Gear Chamber Cover Gasket, upper; also for needle bar drive shaft universal joint opening cover-----	13
38254 S	Needle Bar Drive Shaft Gear Chamber Cover Gasket, rear-----	13
38255	Throat Plate Support (screw No. 22839)-----	16
38257 U	Cast-off Plate Support (screw No. 22569)-----	9
38257 W	Cast-off Plate Support Clamp Plate-----	8
38259	Looper Frame Thread Eyelet (eyelet insert No. 668-27, locking ring No. 21114 M, screw No. 90)--	9
38259 B	Auxiliary Puller Frame Needle Thread Eyelet, for Styles 38200 D, 38200 F (eyelet insert No. 668-27, locking ring No. 21114 M, screw No. 90)-----	9
38259 E	Cast-off Support Eyelet, right (screw No. 22593)---	2
38259 F	Cast-off Support Eyelet, left (screw No. 22781)----	2
38259 G	Looper Thread Frame Eyelet (washer No. 20, screw No. 22848)-----	2
38259 H	Needle Bar Connecting Rod Driving Stud Eyelet (screw No. 90)-----	2
38259 J	Needle Bar Connecting Rod Driving Link Eyelet (screw No. 28)-----	2
38260 A	Auxiliary Puller Presser Roller Bar Bracket, for Styles 38200 D, 38200 F (screw No. 22517)-----	16
38261 A	Auxiliary Puller Feed Roller Shaft Bearing Bracket, for Styles 38200 D, 38200 F (screw No. 22806)----	18
38262	Spacer Plate-----	--
38263	Main Shaft Collar, for Style 38200 C (set screw No. 22894 F)-----	7
38270	Needle Thread Pull-up (screw No. 22585)-----	9
38291 A	Oil Drain Extension Pipe-----	--
38291 E	Oil Drain Clamp-----	--
38292	Spool Stand Bracket (screw No. 22611 A)-----	16
38292 G	Spool Stand Support Stud-----	4
38293 V-161	Portable Stand, complete, for single phase, A. C., 60 cycle, 110 volts electric motor; includes No. 21697 AA belt take-up and hanger assembly and electrical fittings-----	--
38293 V-162	Portable Stand, complete, for single phase, A. C., 60 cycle, 220 volts electric motor; includes No. 21697 AA belt take-up and hanger assembly and electrical fittings-----	--
38293 V-362	Portable Stand, complete, for three phase, A. C., 60 cycle, 220 volts electric motor; includes No. 21697 AA belt take-up and hanger assembly and electrical fittings-----	--

LIST OF PARTS

Symbol to Order By	The figures in the last column refer only to the plates illustrating the parts and are not to be used in ordering. Prices furnished on request.	Plate No.
38294 G	Pitman Lifter Lever (screw No. 22508) -----	12
38294 U	Foot Lifter Bell Crank -----	12
38295	Foot Lifter Bell Crank Stud (nut No. 651-20)-----	11
38295 C	Foot Lifter Lever Bell Crank Spring (screw No. 9846)-	7
38295 G	Foot Lifter Connecting Rod-----	18
38297	Bed Cushioning Springs, for left hand attaching screws-	7
38297 A	Bed Isolating Pads -----	17
38299 A	Belt Guard -----	--
38299 H	Belt Guard Stud (wing nut No. 21369 A)-----	11
39135	Feed Bar Shaft-----	11
39236 A	Needle Rear Guard Washer-----	5
51142	Looper Avoid Eccentric, .096 inch throw, for Style 38200 C (screw No. 22894 D)-----	6
51147	Main Shaft Collar, for Styles 38200 D, 38200 E, 38200 F (screw No. 95)-----	7
51192 A	Looper Thread Tension Eyelet; also left needle thread tension eyelet (eyelet insert No. 668-27, locking ring No. 21114 M)-----	2
51192 G	Needle Thread Tension Eyelet, right (eyelet insert No. 668-27, locking ring No. 21114 M)-----	2
51222	Main Shaft, left section-----	15
51235	Feed Rocker (screw No. 98)-----	9
51235 B	Feed Rocker Shaft-----	11
51235 G	Feed Rocker Arm Washer-----	5
51236	Feed Crank Link (oil wick No. 666-20, shim No. 1248, screw No. 22569, nut No. 35569 J) -----	7
51236 A	Feed Crank Link Pin (screw No. 77) -----	6
51236 B	Stitch Regulating Stud Cap (screw No. 22768)-----	7
51236 C	Feed Crank Stud (nut No. 269)-----	7
51240 D	Looper Connecting Rod, adjusting section (nut, right thread No. 18, nut, left thread No. 269)-----	6
‡51241 D	Looper Connecting Rod Ball Joint Assembly, left, for machines equipped with looper drive levers Nos. 51242 T, 52742 E (bearing screw No. 22729 C, nut No. 18) -----	7
‡51241 J	Looper Connecting Rod, jointed section, and Ball Joint Assembly, right, for machines equipped with looper drive levers Nos. 51242 T, 52742 E (ball stud washer No. 36 G, bearing screw No. 97 A, jointed section No. 55241 D, spring No. 56341 G, nut No. 12538, hinge pin No. 35853 V-156, retaining ring No. 660-310 -----	--
51242 B	Looper Lever Shaft Bushing (screw No. 22597 A)-----	5
51242 C	Looper Drive Lever Bushing -----	5
51242 M	Looper Drive Ball Joint Locking Stud Washer -----	5
51242 T	Looper Drive Lever, steel, with threaded hole for ball stud, for Styles 38200 E, 38200 F-----	9
51243 C	Looper Drive Lever Ball Stud Guide Fork (screw No. 22729 -----	7

‡ See Page 5

LIST OF PARTS

Symbol to Order By	The figures in the last column refer only to the plates illustrating the parts and are not to be used in ordering. Prices furnished on request.	Plate No.
51243 E	Looper Drive Lever Connection Felt Retainer-----	8
51244	Looper Rocker Frame (spot screw No. 96, set screw No. 98)-----	9
51244 A	Looper Rock Shaft -----	11
51244 B	Looper Rock Shaft Arm (set screw No. 77, clamp screw No. 22519 H)-----	7
51244 C	Looper Rock Shaft Spacing Sleeve (screw No. 88 B)-	5
51244 E	Looper Rock Shaft Bushing, also Feed Rocker Shaft Bushing-----	5
51245	Looper Avoid Eccentric Link and Feed Lift Eccentric Link (shim No. 51245 A, screw No. 22569, nut No. 35569 J) -----	7
51245 A	Looper Avoid Eccentric Link Oil Retaining Pad ----	8
51246	Looper Rocker Stud Nut -----	4
51281-216	Cloth Plate Cover, 6 3/4 inches long-----	16
51281 F	Cloth Plate Cover Spring (screw No. 22726 A) ----	8
51290	Main Shaft Bushing, inner, left, 3/4 inch long ----	5
51290 D	Main Shaft Bushing, left, 3/4 inch long-----	5
51292	Tension Post -----	6
51292 C	Tension Regulating Nut -----	4
51292 F-2	Tension Spring, .022 inch diameter wire -----	7
51294	Oil Drain Assembly, includes one each Nos. 666-166, 666-229, 21756 G, 51294 A, 51294 B -----	17
51294 A	Oil Drain Clamp Spring-----	17
51294 B	Oil Drain Connection-----	17
51321	Pulley, round belt, working diameter 3 3/8 inches, for Styles 38200 D, 38200 E, 38200 F; set screw No. 22894 G)-----	14
51430 F	Adjustment Screw Locknut, for presser foot on 24 gauge machines-----	5
51745	Looper Rocker Cone Stud (nut No. 51246)-----	9
52742 E	Looper Drive Lever, steel, with threaded hole for ball stud, for Styles 38200 C, 38200 D -----	9
52743 F	Main Oil Reservoir (screw No. 94) -----	8
52836 C	Feed Rocker Arm (set screw No. 77, clamp screw No. 22519 C)-----	9
52841 G	Looper Drive Ball Joint Locking Stud (washer No. 51242 M, nut No. 52841 H) -----	6
52841 H	Looper Drive Ball Joint Locking Stud Nut-----	4
55241 D	Looper Connecting Rod Jointed Section-----	--
K56188	Pulley Rim (set screw No. 22597 A) -----	--
56341 G	Looper Connecting Rod Jointed Section Spring-----	--
61256 G	Presser Spring Washer, for Styles 38200 D, 38200 F-	5
61257 G	Presser Bar Regulating Bushing -----	6
61341 J	Washer, for BP108 on Style 38200 C-----	--

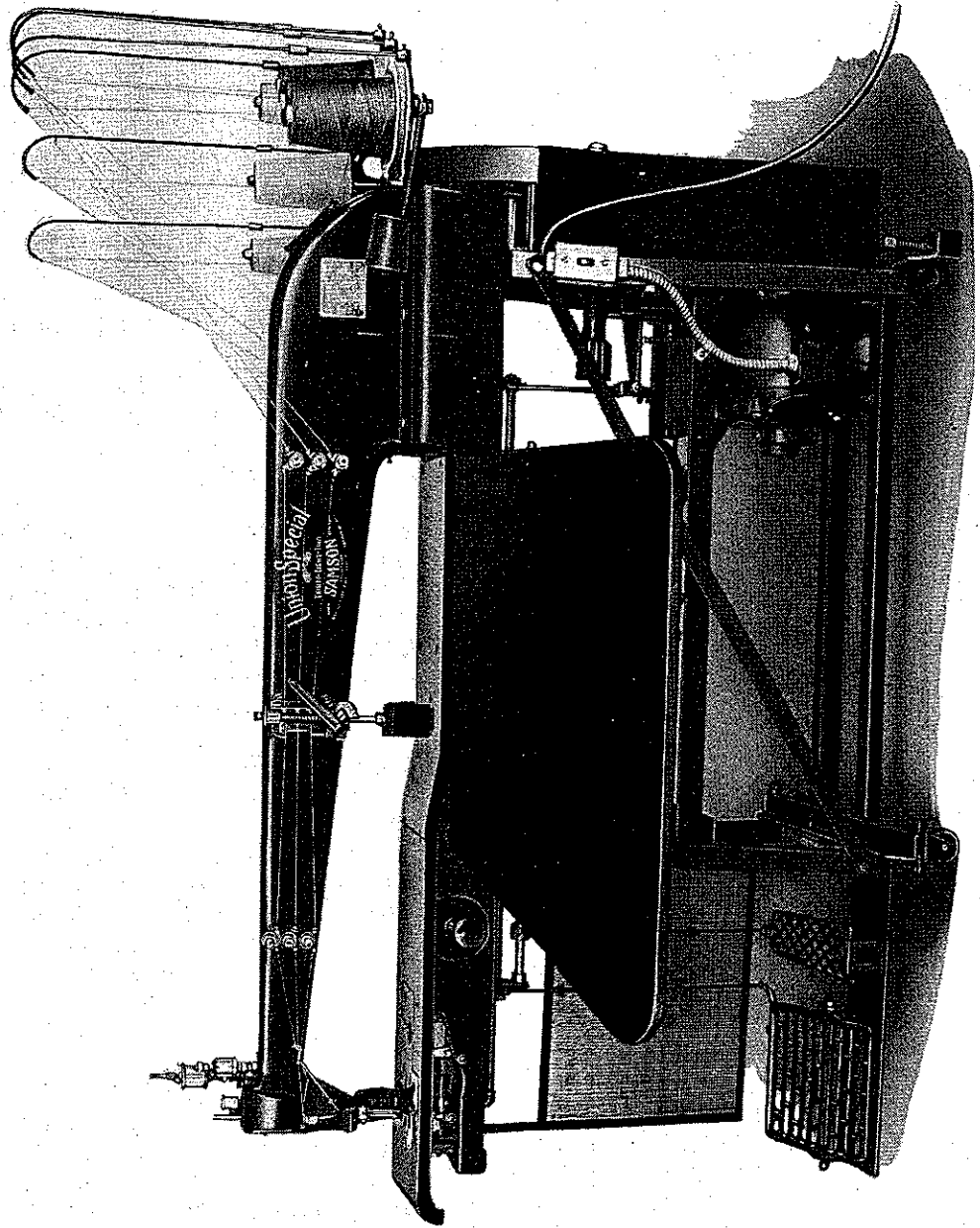

Machine Style 38200 D Mounted on Portable Stand No. 38295 R

High speed UNION SPECIAL machines are available for all canvas seaming operations.

Class 35800 Heavy duty, feed-off-the-arm cylinder felling machine for closing tubular portions of canvas garments, canvas irrigation hose, powder plant safety chutes, etc. Can be fitted for one, two or three needlework on plain lapped or felled seams. Stitch Type 401.

* Style 51300 BK A modern, enclosed type, single needle, flat bed machine equipped with puller for miscellaneous operations on tents, awnings, tarpaulins, etc. 7 3/4 inches of space to right of needle. Makes double locked stitch Type 401.

Style 51500 BL The popular two needle machine for making main seams in canvas goods for outdoor use. Similar to Style 51300 BK. Features enclosed type oiling system for looper drive eccentric and crank. Equipped with puller. Seam Specification 401-LSa-2. Available in Nos. 26 and 48 gauge.

Style 51900 BK Makes triple stitch lap seam 401-LSa-3. Similar in construction to Style 51500 BL. Stitch range 7 to 4 per inch. Standard gauge No. 13.

Class 61400 The "LOCKSTITCH" for miscellaneous single needle work where the Type 301 shuttle stitch is satisfactory. Outstanding for high speed, low maintenance, and uniformity of stitches produced. 11 3/8 inches of space to right of needle.

Information and illustrated literature relative to any of these machines will be furnished on request.

* DISCONTINUED- In most instances, component parts can be ordered for customer repair.

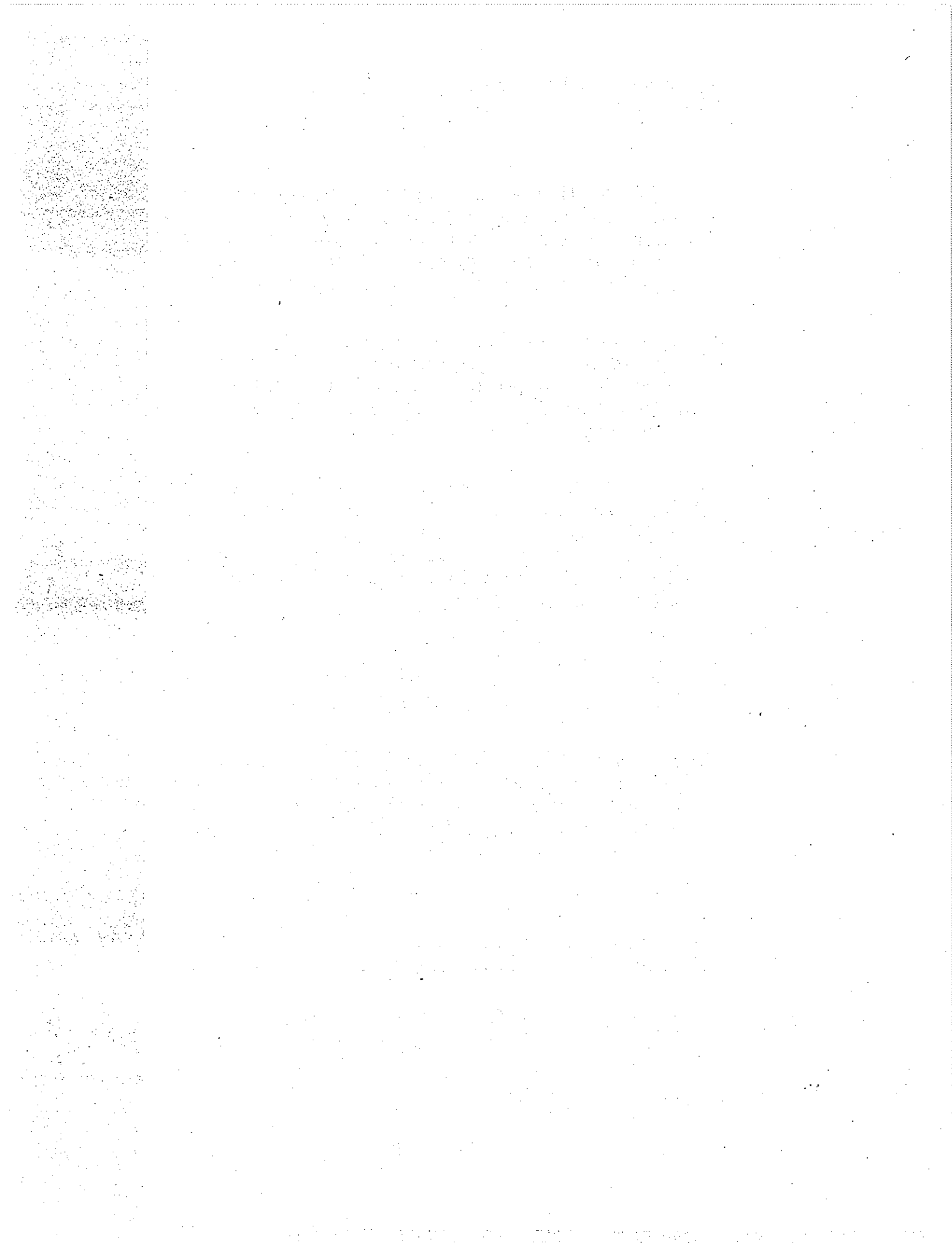

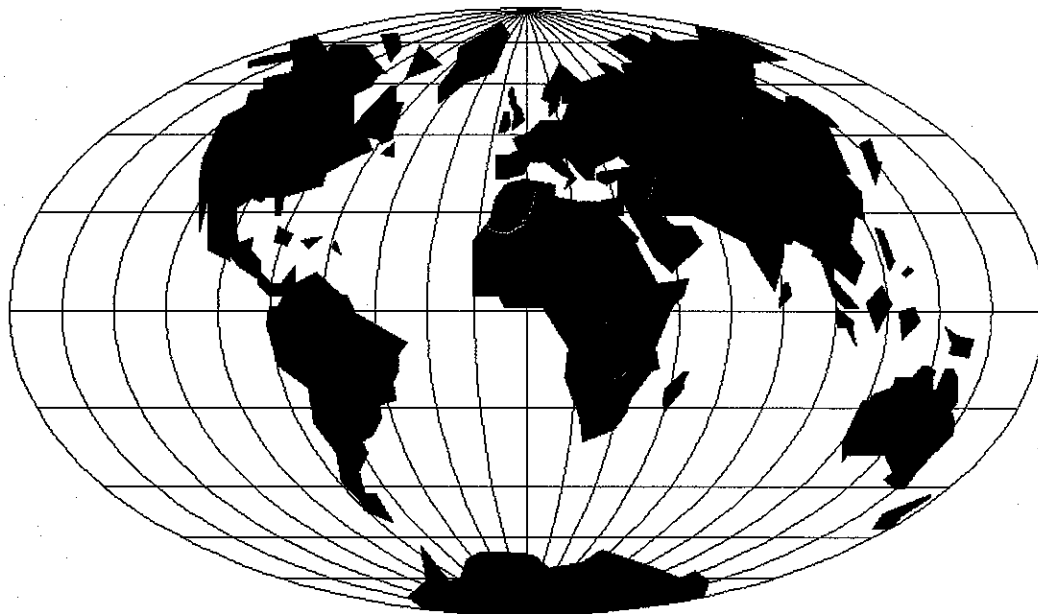

WORLDWIDE SALES AND SERVICE

Union Special Corporation maintains sales and service facilities throughout the world. These offices will aid you in the selection of the right sewing equipment for your particular operation. Union Special Corporation representatives and service technicians are factory trained and are able to serve your needs promptly and efficiently. Whatever your location, there is a qualified representative to serve you.

Corporate Office: One Union Special Plaza
Huntley, IL 60142
Phone: 847•669•5101
Fax: 847•669•1096

European Distribution Center: Union Special GmbH
Raiffeisenstrasse 3
D-71696 Möglingen, Germany
Tel: 49•07141•247•0
Fax: 49•7141•247•100

Brussels, Belgium
Charlotte, N.C.
El Paso, TX
Hong Kong, China
Huntley, IL
Leicester, England
Lille, France
Miami, FL
Milan, Italy
Möglingen, Germany
Montreal, Quebec
Osaka, Japan
Santa Fe Springs, CA

Other Representatives throughout
all parts of the world.



Union Special
INDUSTRIAL SEWING EQUIPMENT