



*Union Special*  
INDUSTRIAL SEWING EQUIPMENT

**STYLES**

**ADJUSTING INSTRUCTIONS AND  
ILLUSTRATED PARTS LIST**

**39500W**

---

---

**STREAMLINE HIGH SPEED  
OVERSEAMERS**

---

---

**CATALOG  
NO. 103W  
SUPPLEMENT  
TO 103S**

**FIRST  
EDITION**

**FIRST EDITION**  
**© 1958**

**PRINTED 1996 IN USA**

**INFORMATION SUBJECT TO CHANGE WITHOUT NOTICE**

**© UNION SPECIAL CORPORATION ALL RIGHTS RESERVED IN ALL COUNTRIES.**

## IDENTIFICATION OF MACHINE

Each UNION SPECIAL machine carries a Style number which is stamped in the name plate on the machine. Style numbers are classified as standard and special. Standard Style numbers have one or more letters suffixed, but never contain the letter "Z". Example: "Style 39500 W". Special Style numbers contain the letter "Z". When only minor changes are made in a standard machine, a "Z" is suffixed to the standard Style number. Example: "Style 39500 WZ".

Styles of machines similar in construction are grouped under a Class number, which contains no letters. Example: "Class 39500".

## APPLICATION OF CATALOG

This catalog is a supplement to Catalog No. 103 S and should be used in conjunction therewith. Only those parts which are used on Style 39500 W and not on Styles 39500 A, B or P are illustrated and listed at the back of the book.

This catalog applies specifically to the standard Style of machine as listed herein. It can also be applied with discretion to some special machines in Class 39500. All references to directions, such as right and left, front and back, etc., are taken from the operator's position while seated at the machine. Operating direction of handwheel is away from operator.

## STYLES OF MACHINES

Two Needle, Two Looper, Four Thread, Overseaming Machine. Differential Feed, Trimming Mechanism with Spring Pressed Lower Knife, Automatic Lubricating System.

39500 W For seaming light to heavy knitted and woven fabrics with a modified safety stitch. For operations on pajamas, bathing suits, house dresses, children's wear, ladies' undergarments, and similar articles, standard width of seam from left needle 17/64 inch, stitch range 6 to 20 per inch, standard setting 10 per inch.

## OILING

CAUTION! Oil was drained from machine when shipped, so reservoir must be filled before beginning to operate. Oil capacity of Class 39500 is eight ounces. A straight mineral oil of a Saybolt viscosity of 90 to 125 seconds at 100° Fahrenheit should be used.

Machine is filled with oil at spring cap in top cover. Oil level is checked at sight gauge on front of machine. Red bulb on oil level indicator should show between gauge lines when machine is stationary.

Machine is automatically lubricated. No oiling is necessary, other than keeping main reservoir filled. Check oil daily before the morning start; add oil as required.

Drain plug screw is located at back of machine near bottom edge of base. It is a magnetic screw designed to accumulate possible foreign materials which may have entered the crank case. It should be removed and cleaned periodically.

## NEEDLES

Each UNION SPECIAL needle has both a type and size number. The type number denotes the kind of shank, point, length, groove, finish and other details. The size number, stamped on the needle shank, denotes largest diameter of blade, measured in thousandths of an inch, midway between shank and eye. Collectively, type and size number represent the complete symbol which is given on the label of all needles packaged and sold by Union Special.

## NEEDLES (Continued)

Style 39500 W uses curved blade needles. The standard needle for this style is Type 154 GAS. It has a round shank, round point, curved blade, standard length, single groove, struck groove, spotted, chromium plated and is available in sizes - 055/022, 065/025, 070/027, 075/029, 080/032, 090/036, 100/040, 110/044, 125/049, 140/054, 150/060.

To have needle orders promptly and accurately filled, an empty package, a sample needle, or the type and size number should be forwarded. Use description on label. A complete order would read: "1000 Needles, Type 154 GAS, Size 090/036".

Selection of proper needle size is determined by size of thread used. Thread should pass freely through needle eye in order to produce a good stitch formation.

Success in the operation of UNION SPECIAL machines can be secured only by use of needles packaged under our brand name, *Union Special*®, which is backed by a reputation for producing highest quality needles in materials and workmanship for more than three-quarters of a century.

## CHANGING NEEDLES

Release pressure on presser foot by turning presser foot release bushing (S, Fig. 1) and swing presser arm (H) out of position. Turn handwheel in operating direction until needles are at their lowest point of travel. Using hexagonal socket wrench No. 21388 AU, furnished with machine, loosen needle clamp nut about 1/4 turn. Again turn handwheel until needles are at their high position; withdraw needles.

To replace needles, leave needle holder at high position and, with the flats to the left, insert needles in holder, one on each side of spacer washer, until they rest against stop pin. Keeping needles in this position, turn handwheel until holder is again at its low point of travel; then tighten nut. Return presser arm (H) to position; re-lock presser foot release bushing (S).

## THREAD STAND

After threads come from cones on thread stand (Z, Fig. 1), they are brought up through back eyelets, then down through front eyelets (Y) and through the adjustable thread guide. Next, they are threaded through each pair of holes in tension thread guide wire (A), down through right hand hole and up through left hand hole. Then thread continues between tension discs (U), through slot (T), and on through thread guide (B).

## THREADING

Only parts involved in threading are shown in threading diagram (Fig. 1). Parts are placed in their relative positions for clarity.

It will simplify threading this machine to follow recommended sequence of threading lower looper first, upper looper second and needles third.

Before beginning to thread, swing cloth plate open, turn handwheel in operating direction until needles (L) are at high position, release pressure on presser foot by turning presser foot release bushing (S); and swing presser arm (H) out of position.

Be sure threads, as they come from the tension thread guide, are between tension discs (U) and in diagonal slots (T) in tension posts (V).

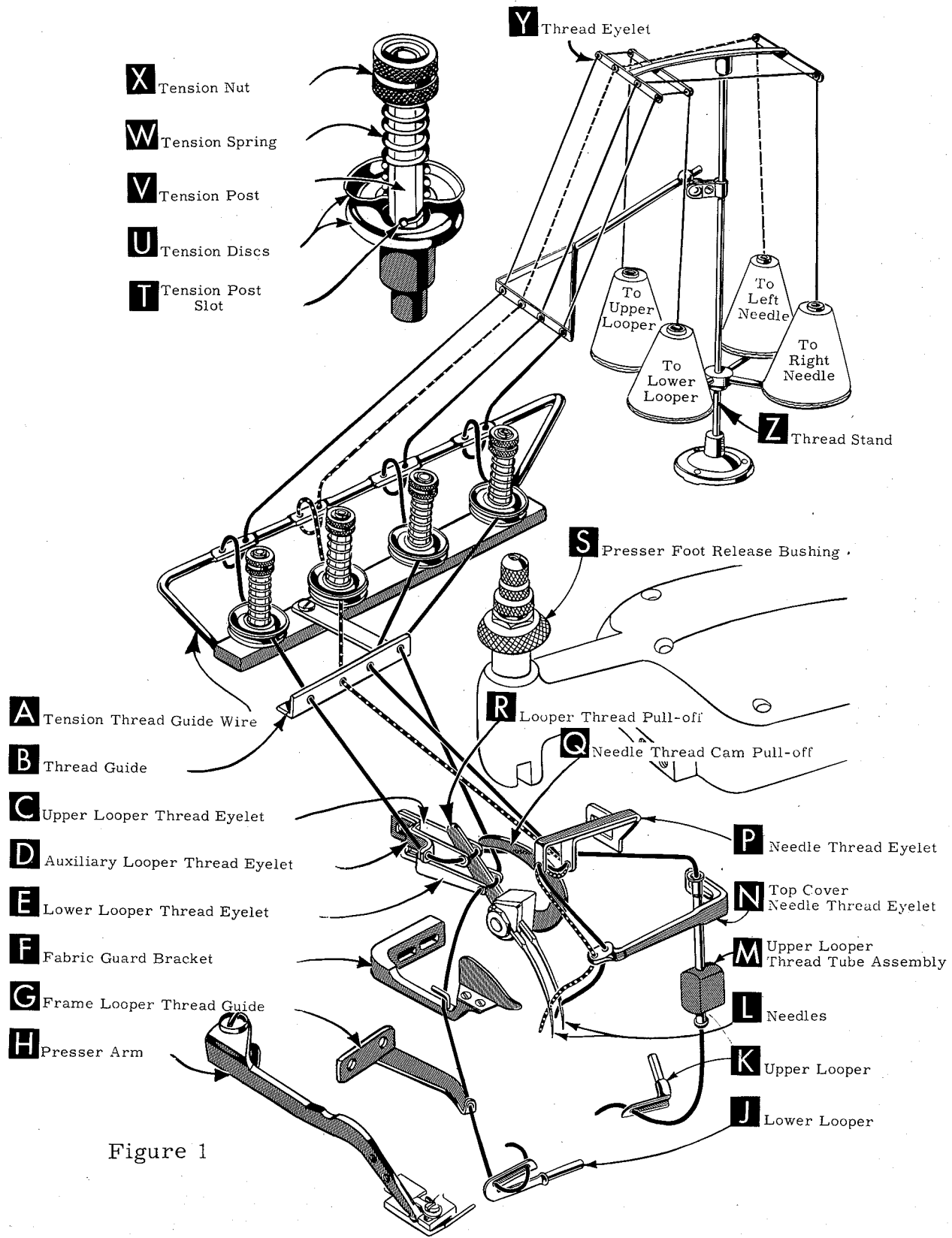

Figure 1

## TO THREAD LOWER LOOPER

Double end of thread and lead it through both eyes of lower looper thread eyelet (E, Fig. 1) from right to left. Note: thread must pass in front of looper thread pull-off (R). Lead thread behind fabric guard (F) and through frame looper thread guide (G). Turn handwheel in operating direction until heel of lower looper (J) is all the way to the left; then thread through both eyes from left to right. Left eye of lower looper can be threaded easily if tweezers are in left hand.

## TO THREAD UPPER LOOPER

Turn handwheel until point of upper looper (K) is all the way left. Lead thread through auxiliary looper thread eyelet (D) from back to front, then through both eyes of upper looper thread eyelet (C) from left to right. Note: thread must pass in front of looper thread pull-off (R). After pulling up upper looper thread tube assembly (M), lead thread under neck of top cover casting and down through thread tube assembly (M). Pull thread out bottom of tube; push tube down, then insert thread through upper looper eye from front to back.

**CAUTION!** Be sure upper looper thread is under lower looper thread when passing from tube assembly to upper looper eye.

## TO THREAD THE NEEDLE

Turn handwheel in operating direction until needles (L, Fig. 1) are at their highest position. Insert both needle threads from right to left, through both eyes of needle thread eyelet (P), under neck of top cover casting; then down through hole in top cover needle thread eyelet (N). Thread needles from front.

## THREAD TENSION

The amount of tension on needle and looper threads is regulated by four knurled tension nuts (X, Fig. 1). Tension on threads should be only enough to secure proper stitch formation.

## PRESSER FOOT PRESSURE

Sufficient pressure to feed work uniformly should be maintained. Should it be necessary to increase or decrease amount of pressure on presser foot, loosen lock nut (A, Fig. 2) and turn adjusting screw (B). Adjusting screw has a right hand thread; so tightening increases pressure, loosening decreases pressure. When pressure adjusting screw (B) has been properly set, tighten lock nut (A). With presser foot resting on throat plate, position locking nut (C) so that its under surface is approximately 1/32 inch to 1/16 inch from the top surface of adjusting screw (B). Set cap (D) against locking nut (C).

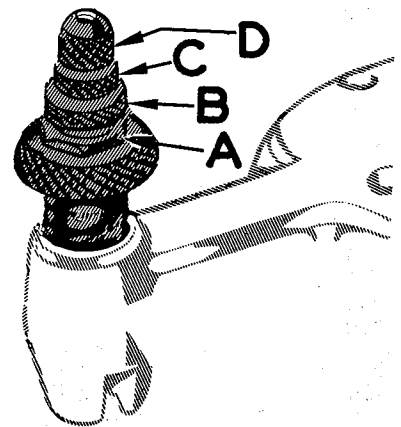

Fig. 2

## FEED ECCENTRICS

Feed eccentrics used in this machine have been selected to produce approximately 10 stitches per inch. It will be noted that the part numbers of feed eccentrics are No. 39540 B-10 for the differential feed and No. 39540 B-12 for the main feed. Minor numbers of the part symbols indicate approximately the number of stitches when using that eccentric. Unless otherwise specified, machine will be shipped with above combination of eccentrics.

## FEED ECCENTRICS (Continued)

Following stitch number feed eccentrics are available under No. 39540 B-4, 5, 6, 7, 8, 9, 10, 11, 12, 13, 14, 15, 16, 18, 20, 22, 24, 26, 28, 30, 32, 34, 36, 40. Only one eccentric is supplied with each machine. Additional eccentrics may be ordered separately. To order an eccentric, use No. 39540 B with a minor number suffixed to indicate number of stitches desired. Example: "39540 B-12".

### ASSEMBLING AND ADJUSTING SEWING PARTS

Before assembling sewing parts, remove cloth plate, fabric guard, chip guard, upper knife assembly, lower knife holder assembly; then follow this suggested sequence:

#### SETTING THE NEEDLE

With the throat plate in position, needles should center in the front end of needle slots. When needles are at high position, needle points should be set  $15/32$  inch above throat plate (Fig. 3). Move needle driving arm (A, Fig. 3), by loosening clamp screw (B). Remove the throat plate.

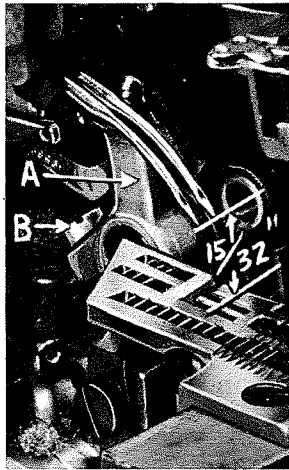

Fig. 3

If needle thread cam pull-off (A, Fig. 4) overlaps looper thread pull-off (B), separate by moving looper thread pull-off to back. When re-tightening looper pull-off screw, be sure to take up end play in needle driving arm.

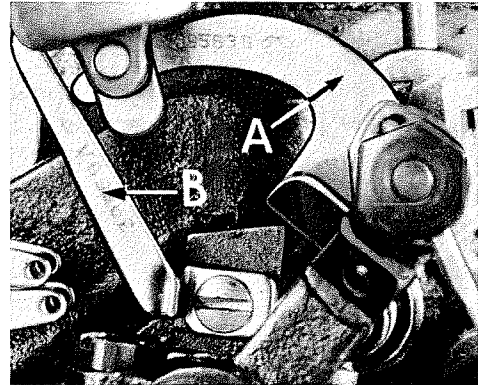

Fig. 4

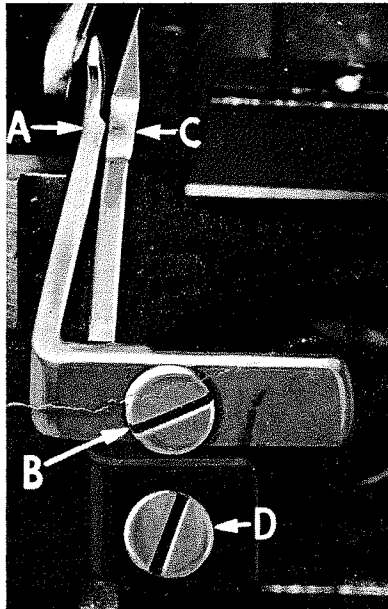

Fig. 5

At this point, insert lower looper (A, Fig. 6) into bar (B). With the lower looper at the left end of its stroke, set point  $1/16$  inch from center of left needle (Fig. 6), using looper gauge No. 21225-1/16.

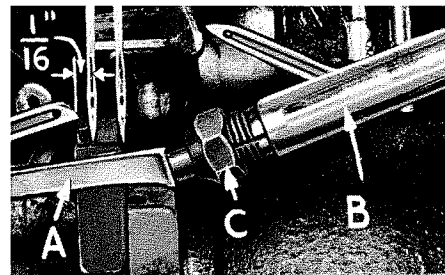

Fig. 6

#### SETTING THE REAR NEEDLE GUARD

Set rear needle guard (A, Fig. 5) as high as possible, without interfering with either lower looper or movement of lower knife holder, but still in position to deflect needles forward  $.002$ -. $.004$  inch. Screw (B) is used to set rear needle guard. Make sure there is no interference between rear needle guard and lower looper.

## SETTING THE LOWER LOOPER

Now, finish lower looper adjustment. As lower looper moves to the right, its point should be set into the scarf of the left needle (A, Fig. 7) until the needles spring forward from rear guard surface another .002-.004 inch.

## SETTING THE FRONT NEEDLE GUARD

Assemble front needle guard (C, Fig. 5). When lower looper is springing needles off back guard, set front needle guard as closely as possible to needles without touching. Use screw (D) to adjust and set front needle guard. After setting, make sure there is no interference between needle guards and differential feed dog.

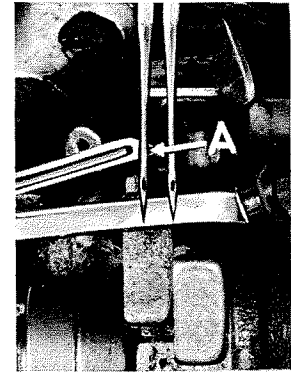

Fig. 7

## SETTING THE UPPER LOOPER

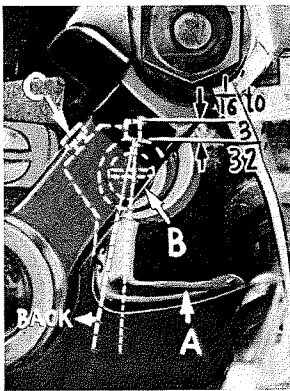

Fig. 8

Insert upper looper (A, Fig. 8) in its holder. Screw (B) holds upper looper in its holder, and permits it to be pushed in or out or turned around its shank. Insert upper looper holder into upper looper shaft, if it is not already in place. Screw (C) on clamp holds the upper looper holder in the shaft. Locate upper looper in its holder so that the shank extends 1/16 to 3/32 inch beyond holder.

When the upper looper is at the right end of its stroke, upper looper holder should be set to position upper looper shank back of vertical (Fig. 8).

By adjusting looper holder in or out of upper looper shaft and by turning the looper around its shank, set upper looper point to cross lower looper to the left of the lower looper eye with 0.002 to 0.004 clearance (Fig. 9).

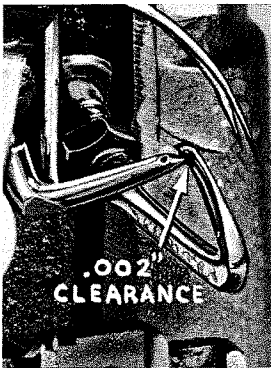

Fig. 9

Next, turn the handwheel until upper looper is at the left end of its travel. Check dimensions of upper looper point with respect to the right needle and throat plate (Fig. 10). If resetting is necessary, do it by moving the upper looper holder (A, Fig. 10). Figure 10 represents the dimensional setting.

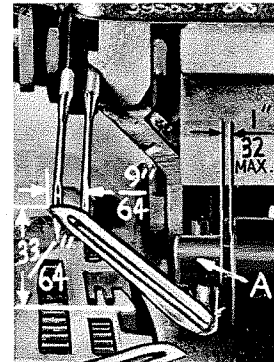

Fig. 10

Dimension 33/64 inch is increased by turning upper looper holder counter-clockwise looking from left end of machine. Dimension 9/64 inch is increased by pulling upper looper holder left, out of the upper looper shaft. A maximum dimension of 1/32 inch (Fig. 10) should be maintained between the upper looper holder and the upper looper shaft. After these changes are made, it may be necessary to turn the upper looper around its shank slightly to maintain the condition shown in Fig. 9.



## SETTING THE UPPER LOOPER (Continued)

When the correct setting is obtained, it can be checked quickly as follows: As upper looper is moving to the right, when upper looper eye centers on the needle, the eyes of the upper looper and needle should align exactly (Fig. 11).

Check setting to avoid interference between upper looper and needle on needle downstroke. If needle rubs the back of upper looper, pull looper out of its holder slightly and rotate looper a short distance counter-clockwise, looking from left end of machine. Reset to maintain dimensions of Fig. 9, 10, 11.

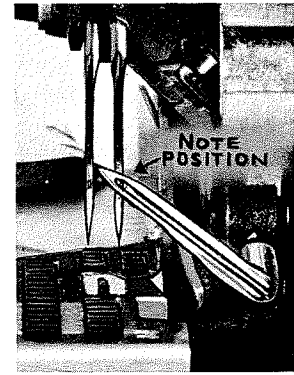

Fig. 11

## SETTING THE FEED DOGS

Assemble the main and differential feed dogs (A, B, Fig. 12). Main and differential feed dogs should be leveled with respect to the throat plate by rotating feed tilting adjusting pin (C). This pin raises or lowers the back end of the feed bar.

The feed dogs should be set level at the time the teeth first appear above the throat plate. Screw (D) locks feed tilting adjusting pin in place. With the

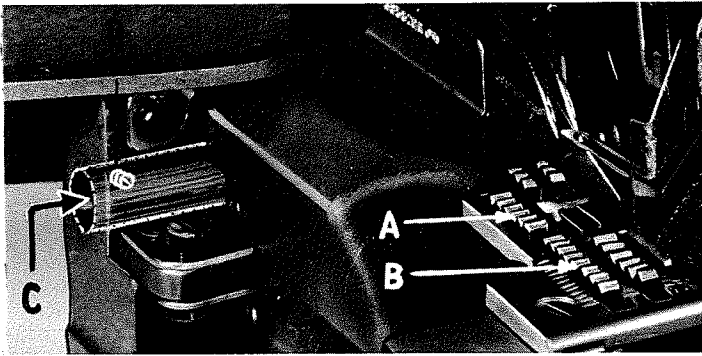

Fig. 12

feed dogs at their highest point of travel, the top of the teeth on the main and differential feed dogs (A, B) should be  $3/64$  inch above the throat plate. The chaining feed dog is made as an integral part of the main feed dog.

## SETTING THE LOWER KNIFE

Replace lower knife holder assembly. Lower knife (A, Fig. 13) should be set with cutting edge flush with throat plate surface. Adjustments are made with hexagonal head screw which holds lower knife. Lower knife is spring pressed against upper knife, so no lateral adjustment is necessary when width of trim is changed.

Lower knife may be secured in any position by tightening screw (B) and locking nut (C) against support bracket. Because screw (B) also serves as latch pin for the cloth plate latch spring, it should always be locked with nut (C) even when screw is not tightened against lower knife holder.

## SETTING THE UPPER KNIFE

Replace upper knife assembly. Clamp upper knife (D, Fig. 13) in position, setting nut (E) to hold clamp (F) in its most clockwise position against upper knife. Upper knife chain guard (J) should be positioned so that the guarding section is approximately  $1/64$  inch behind the cutting edge and in contact with the top surface of the upper knife.

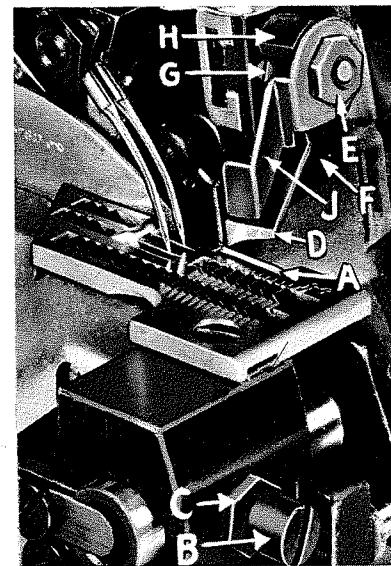

Fig. 13

## SETTING THE UPPER KNIFE (Continued)

At the bottom of its stroke, front cutting edge of upper knife should extend not less than 1/64 inch below cutting edge of lower knife.

After upper knife has been set for proper width of trim, screw (G) must be tightened to lock the upper knife holding block (H) in place. This will simplify resetting when upper knife is replaced.

## SETTING THE STITCH LENGTH

Length of stitch is determined by the combination of feed eccentrics used. Outer (left) eccentric (A, Fig. 14) actuates main (rear) feed dog; while the inner (right) eccentric (B) actuates the differential (front) feed dog.

In assembling feed eccentrics, be sure hubs are facing each other. Be careful not to damage shaft or key. Tighten nut (C) securely. Be sure wool yarn in oil tube (F) touches feed eccentric connections.

To change feed eccentrics, remove nut (C) from end of shaft (D). Turn handwheel in operating direction until key slot in eccentric is toward front. Using hooked eccentric extractor (E), supplied with machine, reach behind eccentrics as shown and withdraw eccentrics. It may be necessary to move handwheel back and forth slightly during extraction.

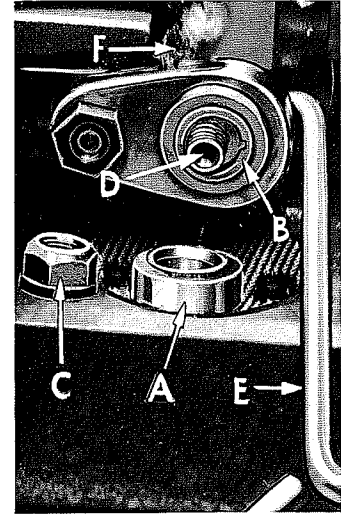

Fig. 14

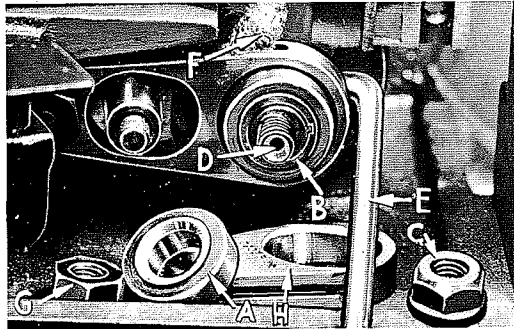

Fig. 15

If eccentrics are unusually tight fitting, in addition to removing nut (C, Fig. 15) from shaft (D), it may be helpful to remove nut (G) and feed driving connection (H). Then continue as originally suggested.

## SETTING THE PRESSER FOOT

Assemble presser foot to presser arm. With needle in high position, swing presser arm into sewing position and lock in place. If necessary, presser foot can be realigned with throat plate slots by shifting foot lifter lever shaft.

Foot lifter lever arm (A, Fig. 16) and collar (B) secure the shaft. Be sure presser arm does not bind and rise when presser foot release bushing is unlocked. To center presser foot and stitch tongue with respect to throat plate needle hole, loosen presser foot hinge screw.

Adjust lifter lever stop screw (C) so that presser foot can be raised no higher than upper looper will permit; then, lock nut (D). To find this maximum safe position, turn the handwheel so point of upper looper is directly over presser foot tongue. Raise presser foot by depressing the presser foot treadle and manually lower the toe of foot. Height adjustment is correct if presser foot tongue does not contact the upper looper. There should be from 1/16 to 1/8 inch free motion of foot lifter lever before presser foot begins to rise. This adjustment is made with screw (E), locked with nut (F).

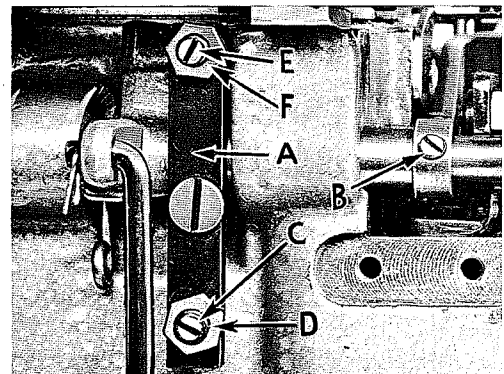

Fig. 16

Finally, re-assemble chip guard, fabric guard, cloth plate.

## STARTING TO OPERATE

Be sure machine is threaded according to threading diagram (Fig. 1, page 5). With thread tensions light, set looper thread eyelets (C & E) about horizontal and in the middle of their front to back locations. Operate machine slowly, without presser foot in place, to make sure that chain forms and moves off the tongue freely. Swing presser foot into position, insert material, and sew slowly.

### NEEDLE THREAD CONTROL

While sewing on material, check needle thread control as follows: Usually all needle thread is drawn on needle down stroke. At top of needle stroke, thread should be just tight enough to feed chain off stitch tongue. Stitch tends to pull down slightly if excessive thread is pulled on the up stroke. With needle at bottom of stroke, position needle thread eyelet (P, Fig. 1) so that needle cam pull-off (Q) just contacts needle thread

### LOWER LOOPER THREAD CONTROL

With material under presser foot, set lower looper thread eyelet (E, Fig. 1) back far enough so thread is a little slack when looper thread pull-off (R) reaches its most rearward position. Looper thread pull-off (R) is set about 1/8 inch distance behind needle thread cam pull-off (Q). Frame looper thread guide (G) should be set with its eyelet approximately 1/8 inch right of lower looper (J) heel eyelet at the time lower looper is at extreme left end of its travel.

While sewing on material, check drawing off of looper thread as follows: A portion of lower looper thread should be drawn through the tension before lower looper thread comes off upper looper. To increase amount of thread drawn through the tension while lower looper thread is on upper looper, move lower looper thread eyelet (E) down, keeping the same amount of pull-off action.

### UPPER LOOPER THREAD CONTROL

Before proceeding to adjust upper looper thread eyelet (C, Fig. 1) balance all four tensions to give a normal appearing stitch. Moderate change in these tensions will not markedly effect the purl.

During needle down stroke, forward stroke of looper thread pull-off (R) will draw upper thread through the tension. When normal amount of looper thread is drawn, upper looper thread will have almost all slack taken up as looper thread pull-off reaches its most rearward position.

### POSITIONING THE PURL

To move the purl more under the edge, both looper thread eyelets (C & E, Fig. 1) should be raised keeping the same amount of pull-off. Usually it is better to have slightly more pull-off on upper thread than on lower thread.

If it becomes necessary to move looper thread pull-off (R) be sure to take up all end play in needle drive shaft before tightening. If upper looper is located so that it is higher over throat plate than recommended in (Fig. 10), the purl will tend to form near top edge. If upper looper is too low, the purl will form nearer bottom edge.

### THREAD TENSIONS

The needle thread tension required is a function of needle thread and material being sewn. In general, lower looper thread tension should be set as high as possible without causing needle thread to be pulled down. Upper looper thread tension should be increased as long as the elasticity of the chain increases, or until the purl is pulled too far over the top.

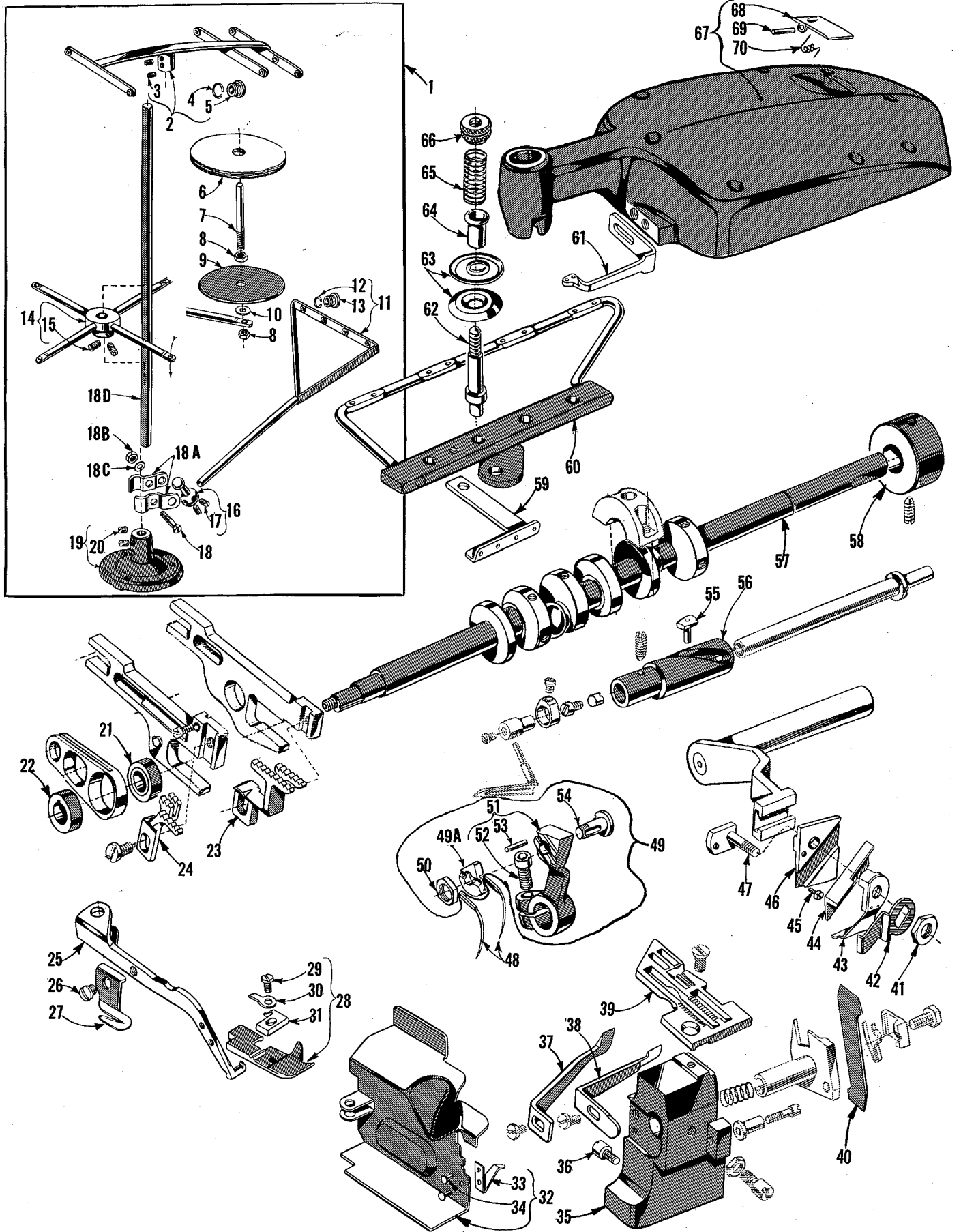

The parts illustrated on the preceding page and described on this page represent the parts that are used on Style 39500 W, but are not used on Style 39500 P.

Those parts shown in phantom views and bearing no reference numbers are common to Styles 39500 W and 39500 P.

Use Catalog No. 103 S for all parts not illustrated or described here.

Ref. No.	Part No.	Description	Amt. Req.
1	21101 H-4	Thread Stand, complete -----	1
2	21114 H-4	Eyelet Support -----	1
3	22651 CD-4	Screw -----	2
4	21114 M	Eyelet Locking Ring -----	8
5	21114 L	Eyelet -----	8
6	21104 V	Pad -----	4
7	21114 W	Spool Pin -----	4
8	258 A	Nut -----	8
9	21114	Spool Seat Disc -----	4
10	652-16	Washer -----	4
11	21114 S-4	Lead Eyelet -----	1
12	21114 M	Eyelet Locking Ring -----	4
13	21114 L	Eyelet -----	4
14	21114 D-4	Spool Seat Support -----	1
15	22651 CD-5	Screw -----	2
16	21114 T	Lead Eyelet Socket Ball -----	1
17	22651 CD-4	Screw -----	2
18	22810	Screw -----	1
18A	21114 U	Lead Eyelet Ball Split Socket -----	2
18B	21104 H	Nut -----	1
18C	652-16	Washer -----	1
18D	21104 B-24	Thread Stand Rod -----	1
19	21114 A	Thread Stand Base -----	1
20	22651 CD-5	Screw -----	2
21	39540 B-10	Differential Feed Driving Eccentric, .022 inch throw -----	1
22	39540 B-12	Main Feed Driving Eccentric, .006 inch throw -----	1
23	39526 W	Differential Feed Dog -----	1
24	39505 W	Main Feed Dog, marked "W" -----	1
25	39556 F	Presser Arm -----	1
26	88 A	Screw -----	1
27	39556 K	Chain Cutting Knife -----	1
28	39520 W	Presser Foot -----	1
29	22768 B	Screw -----	1
30	39530	Hinge Spring -----	1
31	39597 W	Stitch Tongue, marked "EF" -----	1
32	39582 GG	Side Cover -----	1
33	39582 H	Spring -----	1
34	39582 J	Rivet -----	2
35	39580 AD	Throat Plate and Lower Knife Support Bracket -----	1
36	22585 G	Latch Screw, for side cover -----	1
37	39525 F	Needle Guard, front -----	1
38	39525 N	Needle Guard, rear -----	1
39	39524 W	Throat Plate -----	1
40	39549 J	Lower Knife -----	1
41	14077	Nut -----	1
42	39571 B	Upper Knife Chain Guard -----	1
43	39571 F	Upper Knife Clamp -----	1
44	39570 J	Upper Knife -----	1
45	22738	Screw -----	1
46	39572	Upper Knife Holder Block -----	1
47	39571 D	Upper Knife Clamp Stud -----	1
48	154 GAS	Needle -----	2
49	29477 HT	Needle Driving Arm Assembly -----	1
49A	39551 D	Needle Spacer Washer -----	1
50	14077	Nut-Needle Clamp Stud -----	1
51	39552 F	Needle Driving Arm -----	1
52	22596 E	Screw -----	1
53	51-45 Blk.	Stop Pin -----	1
54	39551 C	Needle Clamp Stud -----	1
55	39543 T	Cam Follower -----	1
56	39543 S	Bushing and Cam Guide -----	1
57	29477 JP	Crankshaft Sub-Assembly -----	1
58	29480 LB	Crankshaft Bearing Kit of Parts, inner right -----	1
59	39663 A	Thread Guide -----	1
60	39592 G	Tension Post Mounting Bracket -----	1
61	39563 W	Top Cover Needle Thread Eyelet -----	1
62	35792 H	Tension Post -----	4
63	109	Tension Disc -----	8
64	107	Tension Post Ferrule -----	4
65	51292 F-4	Tension Spring, looper thread -----	2
	51292 F-8	Tension Spring, needle thread -----	2
66	108	Tension Post Nut -----	4
67	39582 T	Top Cover -----	1
68	39582 L	Oil Filler Cover -----	1
69	51-103 Blk.	Hinge Pin -----	1
70	39582 V	Spring -----	1
*	39501 AH	Cloth Plate -----	1
*	39578 BB	Chip Guard -----	1
*	39594 P	Oil Collector Plate -----	1

\*Parts not shown on picture plate.





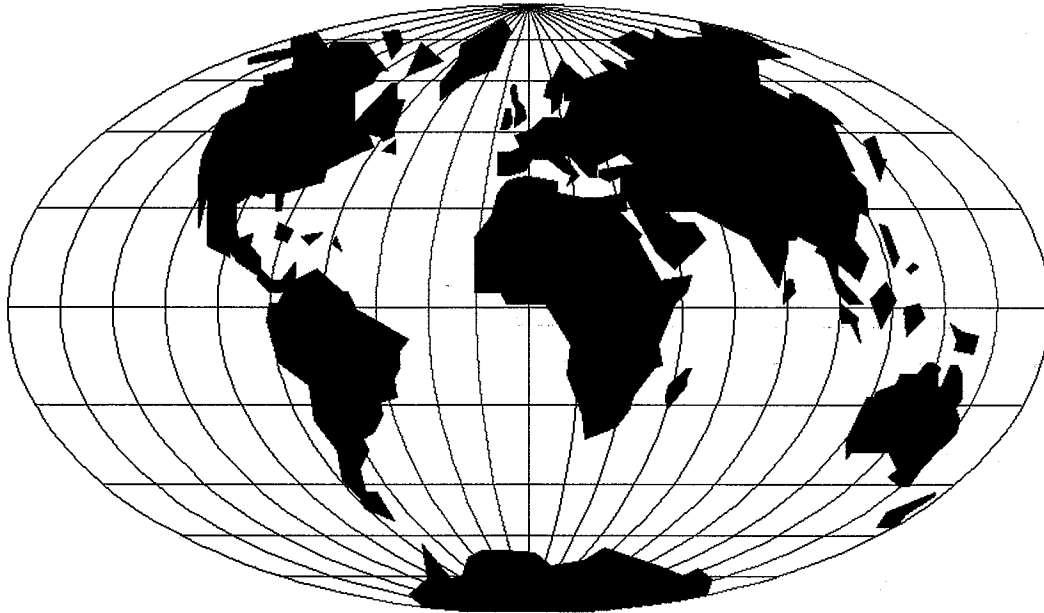

## WORLDWIDE SALES AND SERVICE

Union Special Corporation maintains sales and service facilities throughout the world. These offices will aid you in the selection of the right sewing equipment for your particular operation. Union Special Corporation representatives and service technicians are factory trained and are able to serve your needs promptly and efficiently. Whatever your location, there is a qualified representative to serve you.

---

**Corporate Office:** One Union Special Plaza  
Huntley, IL 60142  
Phone: 847•669•5101  
Fax: 847•669•1096

**European Distribution Center:** Union Special GmbH  
Raiffeisenstrasse 3  
D-71696 Möglingen, Germany  
Tel: 49•07141•247•0  
Fax: 49•7141•247•100

Brussels, Belgium  
Charlotte, N.C.  
El Paso, TX  
Hong Kong, China  
Huntley, IL  
Leicester, England  
Lille, France  
Miami, FL  
Milan, Italy  
Möglingen, Germany  
Montreal, Quebec  
Osaka, Japan  
Santa Fe Springs, CA

Other Representatives throughout  
all parts of the world.



*Union Special*<sup>®</sup>  
INDUSTRIAL SEWING EQUIPMENT