

CATALOG NO. 34

LARGE ARM
FLAT BED MACHINES

CLASSES 6900, 10300, and 12700

UNION
SPECIAL
MACHINE
M. C.

HOME OFFICE, 300 WEST KINZIE STREET

WORKS

West Kinzie, North Franklin and West Michigan Streets

CHICAGO, ILL., U. S. A.

LARGE ARM FLAT BED MACHINES

CLASSES 6900, 10300 and 12700

with

ILLUSTRATIONS

and

PRICE LIST OF PARTS FOR REPAIRS ONLY

CATALOG No. 34

UNION SPECIAL MACHINE COMPANY
CHICAGO, ILLINOS

BRANCH OFFICES:

NEW YORK
COHOES, N. Y.
ST. LOUIS

PHILADELPHIA
ROCHESTER, N. Y.
MINNEAPOLIS

BOSTON
UTICA, N. Y.
SAN FRANCISCO

AMSTERDAM, N. Y.
CINCINNATI

Copyrighted 1912
Union Special Machine Company
Chicago, Illinois

IMPORTANT NOTICE TO CUSTOMERS

The parts listed in this catalog are furnished at list prices for repairs only.

Attention is hereby called to the fact that many of said parts are subjects of patents, or enter into patented combinations, and that in furnishing these parts at list prices we only license their use for repairing machines of our own make, in their original condition.

Notice is hereby given that the sale of such parts by the purchaser, or the use thereof for changing over machines from one style to another, or for any other than *bona fide* repair purposes, is an infringement, for which the seller or user will be liable to prosecution.

CONTENTS

The matter of this catalog relates only to machines in Classes 6900, 10300 and 12700, and cannot be applied to machines in other classes. The class number can be ascertained by reference to the name plate on the machine. Power transmitter parts are listed in a separate catalog.

| | Page |
|--|------|
| Important Notice to Customers..... | 3 |
| Illustration of Machine Showing Installation..... | 5 |
| Description of Machines..... | 6 |
| Oiling Diagram Style 6900 G..... | 8 |
| Oiling Diagram Class 10300..... | 9 |
| Thread Stands..... | 10 |
| Needles..... | 11 |
| Needle Prices..... | 12 |
| Illustrations and Price List of Parts, Explanation of..... | 13 |
| Plates..... | 14 |
| Price List of Parts..... | 43 |

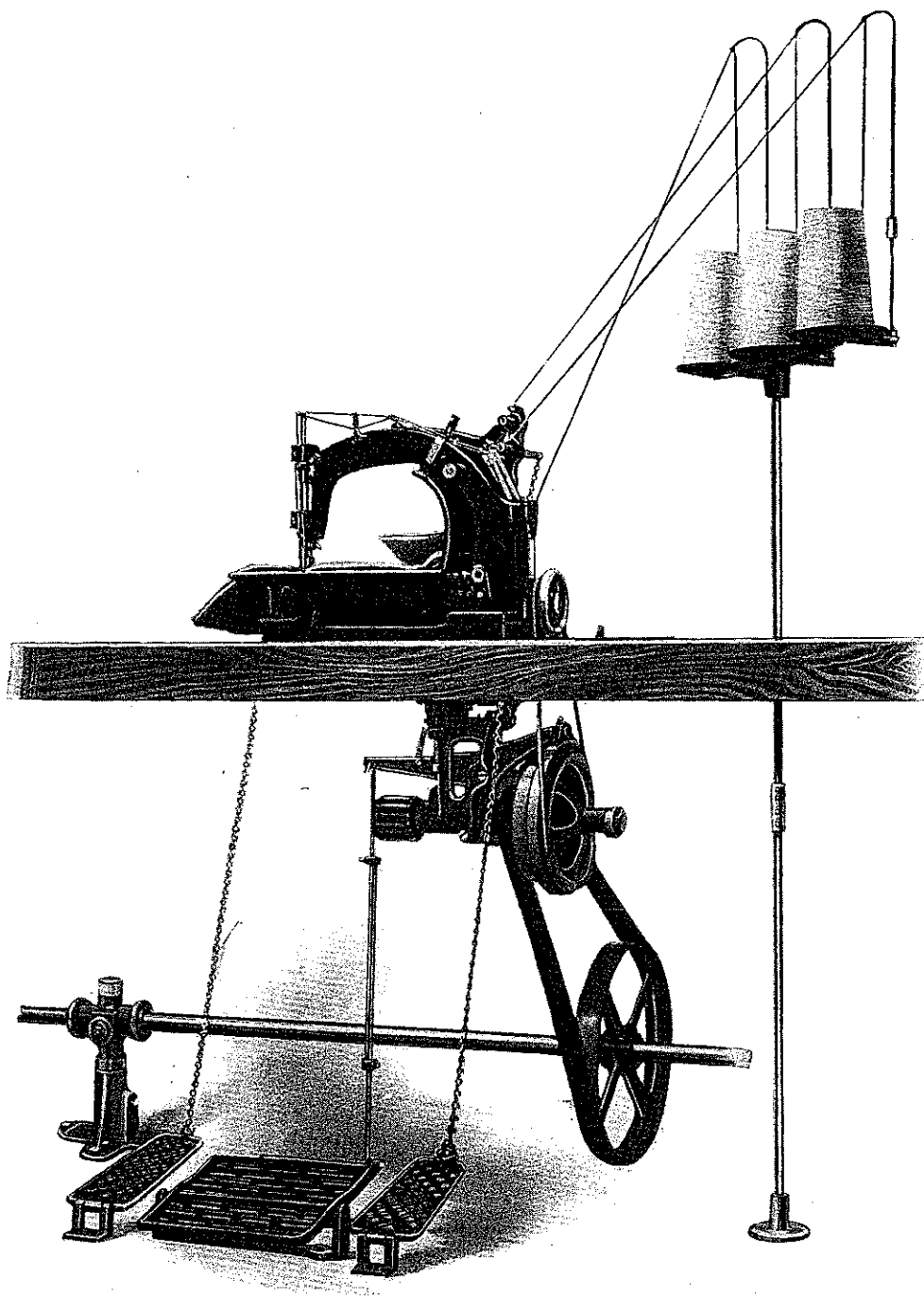

STYLE 6900 G—READY TO OPERATE

DESCRIPTION OF MACHINES

The **Class Number** is stamped on the name plate and represents a type of machines subdivided into several styles.

The **Style Number** consists of the class number and a letter and is given only in the catalog. It represents a machine as fitted for a designated kind of work.

The **Gauge Number** represents the space between the rows of needle punctures. The spacing of gauges Nos. 8 to 36 inclusive, is as follows:

| Gauge No. | Space | Gauge No. | Space |
|-----------|----------------------|-----------|--------------------------------|
| 8..... | $\frac{1}{8}$ -inch | 30..... | $\frac{1}{3}\frac{5}{2}$ -inch |
| 12..... | $\frac{3}{16}$ -inch | 32..... | $\frac{1}{2}$ -inch |
| 16..... | $\frac{1}{4}$ -inch | 36..... | $\frac{9}{16}$ -inch |
| 24..... | $\frac{3}{8}$ -inch | | |

Two needle machines listed in this catalog are furnished only in Nos. 8, 12 and 16 gauges.

On machines in Class 12700, the number following the first hyphen (-) represents the distance between the left-hand and the center needle. The number following the second hyphen (-) represents the distance between the center and the right-hand needle.

STYLES OF MACHINES IN CLASS 6900

Large Arm Flat Bed Two Needle Machines, One Looper, Twin Needle Stitch, Short Needles

Style

- 6900 E—For imitation hemstitch work; (specify gauge of machine)
- 6900 G—For ornamental stitching, knit underwear, etc., with under trimmer (specify gauge of machine)
- 6900 H—For folding and stitching belt loops for trousers; strips cut in short lengths (specify gauge of machine)

STYLES OF MACHINES IN CLASS 10300

Flat Bed, Twin Needle Overstitch Machines, Short Needles

Style

- 10300 B—For sewing lace edging on knit underwear, etc., with large cloth plate (specify gauge of machine)
- 10300 C—For finishing cut edges, knit underwear, etc., with feed cap and narrow cloth plate (specify gauge of machine)
- 10300 D—For sewing lace edging on knit underwear, etc., with feed cap and narrow cloth plate (specify gauge of machine)

DESCRIPTION OF MACHINES

Style

10300 F—For sewing lace edging on knit underwear, etc., with large cloth plate and tandem differential feed (specify gauge of machine)

10300 G—For sewing lace edging on knit underwear, etc., with feed cap, narrow cloth plate and tandem differential feed (specify gauge of machine)

STYLES OF MACHINES IN CLASS 12700

Large Arm Flat Bed Three Needle Combination Machines, Single Needle and Twin Needle Stitch, Short Needles

Style

12700 A—For sewing lace edging on knit underwear, etc., collarette finish; lace next to presser foot, twin needle stitch on right-hand side (specify both gauges of machine and submit sample of lace)

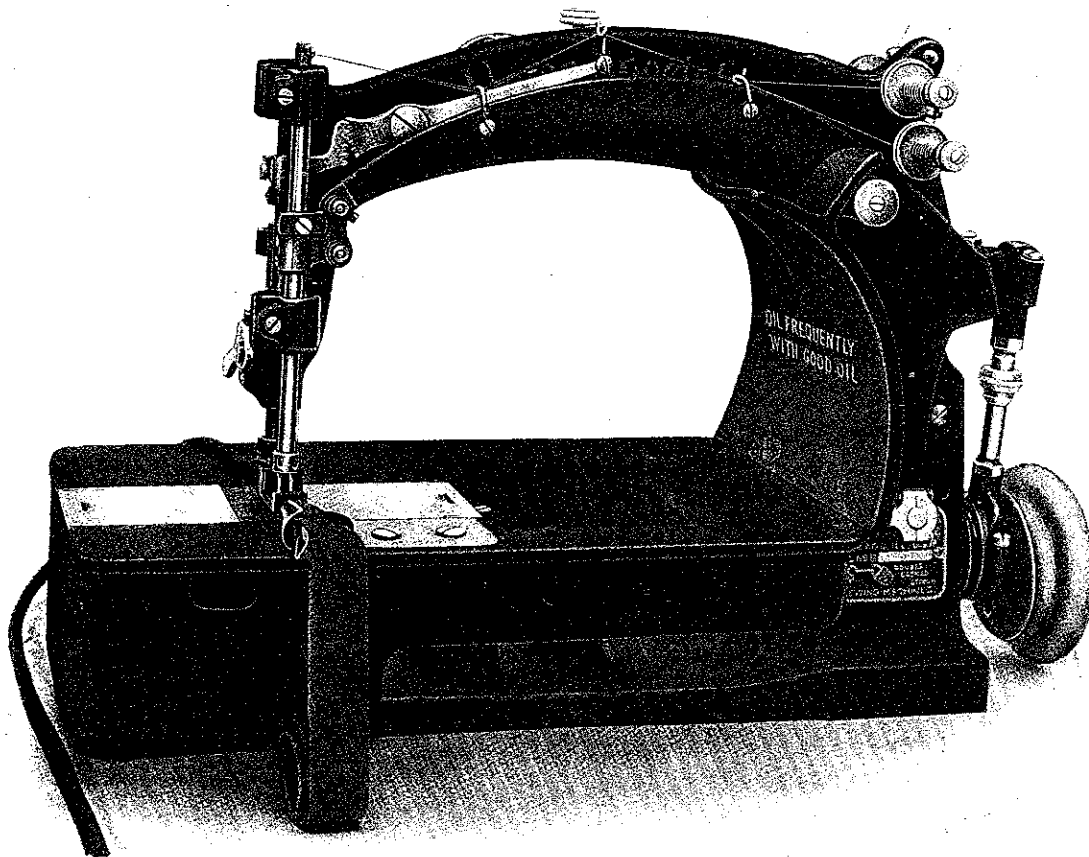

STYLE 6900 H.

OILING DIAGRAM

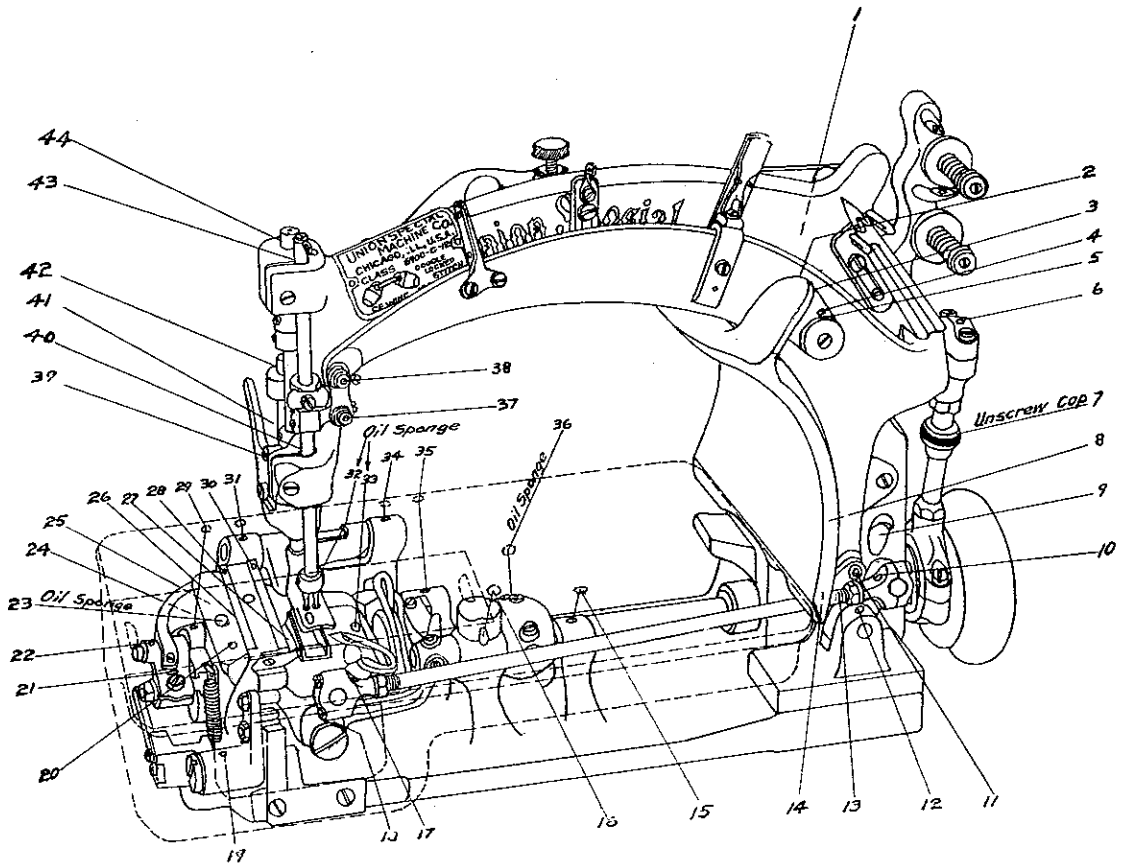

STYLE 6900 G.

OILING DIAGRAM

2
3
4
5
6
7
8
9
10

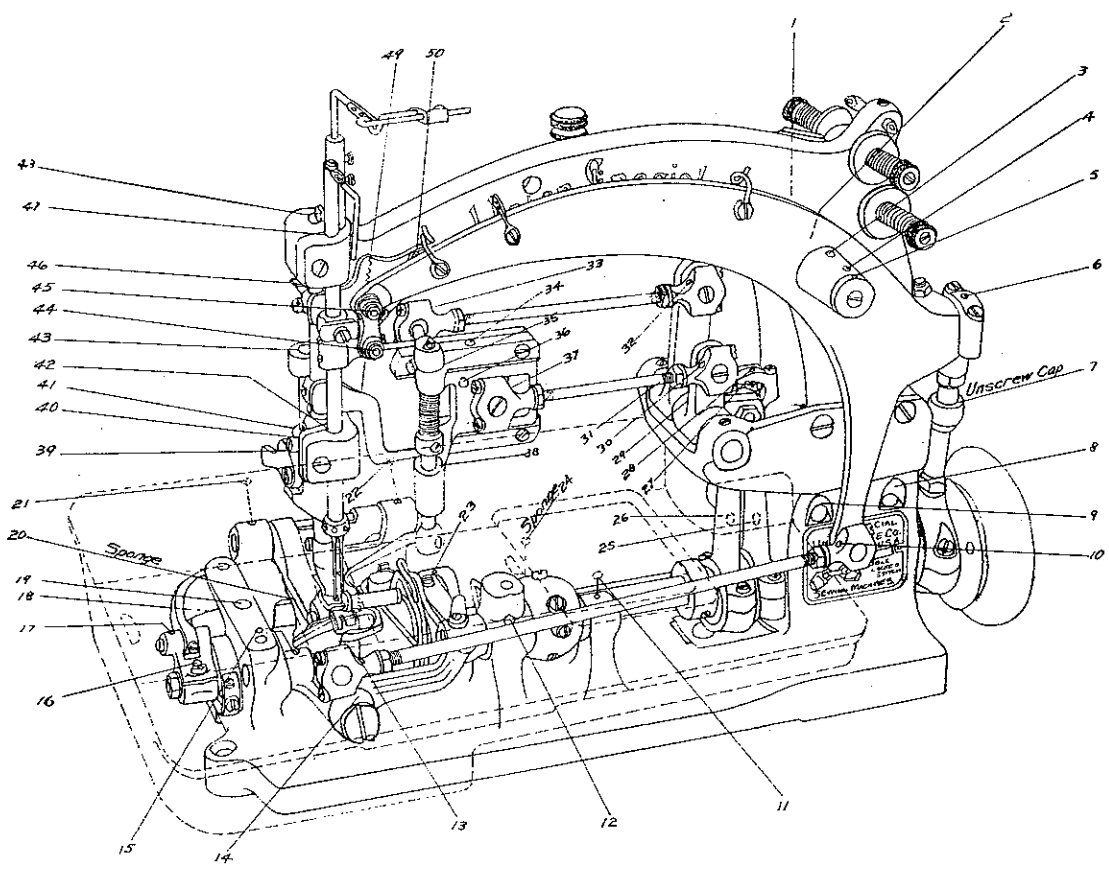

CLASS 10300

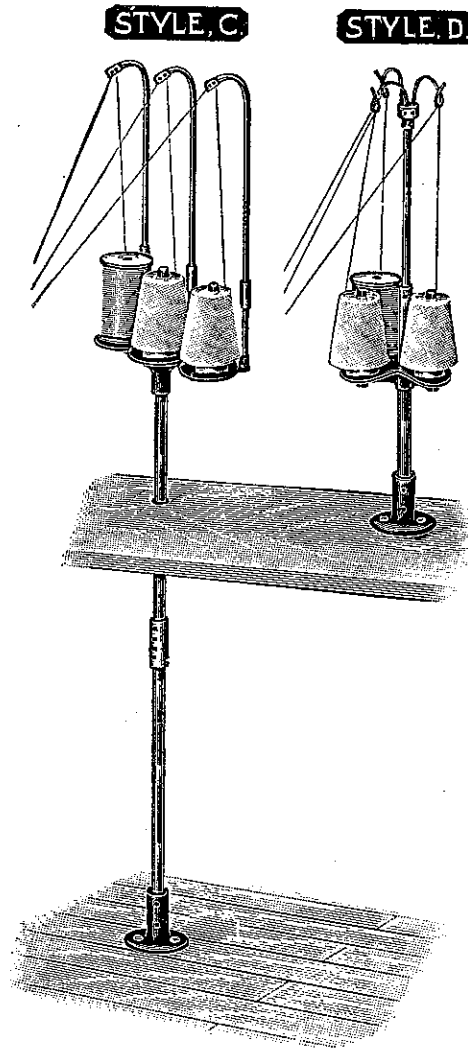

Thread Stands The above $\frac{1}{16}$ -size illustration shows two styles of thread stands set up ready for use. One of these styles is furnished with each of these machines. It should be placed back of the machine pulley and a short distance to the right.

Style C To obviate the effects of vibration on the spools, this style is generally fastened to the floor, the jointed rod passing centrally through a $\frac{3}{4}$ -inch hole in the table. However, if so desired, the base can be fastened to the top of the table, using only one part of the rod.

Thread wire extensions, No. 21113 A, are furnished only where large cones of thread are used.

Style D This style is designed to be fastened on the table, but by ordering an extra rod, No. 21126, a coupling, No. 21127, and four coupling screws, No. 22580, it can be fastened to the floor.

The spool support can be adjusted to any height desired above the table and the thread guides to any height above the spools.

NEEDLES

Ordering To have orders promptly and accurately filled, the empty package, a sample needle, or the full description should be given. See marks on packages. An intelligible order would read as follows:

100 needles, No. 1, round shank, short, double groove, round point.

100 needles, No. 2, round shank, short, double groove, ball eye, round point.

100 needles, No. 4, round shank, short, double groove, ball eye, round point, spotted.

100 needles, No. 2, round shank, short, round point, double groove, ball eye, spotted, nickel plated, Government.

Success in the operation of these machines can be assured only by the use of genuine Union Special Needles, furnished by the Union Special Machine Company. Obviously, it is to our interest to maintain the reputation of the machines by furnishing the very best needles obtainable.

Terms Attention is directed to our established practice. Prices on needles are strictly net. Leaving the factory in perfect condition, packed with skillful care, they are forwarded at the buyer's risk, f. o. b., Chicago. Regular postage rates will be charged on all needles sent by mail.

Illustrations Each needle illustration shows: (1) A full size needle, (2) a magnified view of its point, and (3) its incision relative to the line of stitching, as indicated by dotted lines.

Sizes of Needles The needles increase in size as follows: Nos. 000, 00, 0, 1, 2, 3 and 4. The Government round point needles are made in sizes Nos. 2 and 3 only.

The Round Point This point, sometimes called "cloth point," is almost universally used on cloth and knit goods work. Having no sharp edges, it consequently forces its way through the fabric. The illustrations and descriptions on the following page show the several styles.



The ball eye needles are used on fabrics that offer considerable resistance to needle penetration. To reduce the friction between the blade and the fabric, they are larger at the eye than at any part of the blade.

NEEDLES

The nickel plated needles also are used on fabrics that are difficult to penetrate, as the nickel reduces the friction.

The Government round point needles are especially designed for seaming such closely woven fabrics as khaki. They have a long, tapering point. To give them additional strength, the grooves are narrower and shallower, consequently it requires a needle two sizes larger for a given size thread.

The spotted needles are used in the large sizes. They have a spot milled out on the rear side just above the eye. This provides a clearance for the loopers and enables them to be set closer to the center of the needles.

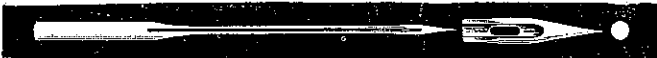
| | |
|---|---------|
|  | \$16 00 |
| Round shank, short, round point, double groove, per M | \$16 00 |
| Round shank, short, round point, double groove, nickel-plated, Per M | 11 00 |
|  | 10 00 |
| Round shank, short, round point, double groove, ball eye, per M | 10 00 |
| Round shank, short, round point, double groove, ball eye, nickel-plated, per M | 11 00 |
|  | 12 00 |
| Round shank, short, round point, double groove, ball eye, spotted, No. 4 and smaller, per M | 12 00 |
|  | 13 00 |
| Round shank, short, round point, double groove, ball eye, spotted, nickel plated, Government, per M | 13 00 |

ILLUSTRATIONS AND PRICE LIST OF PARTS FOR REPAIRS ONLY

Plates Grouped according to scale will be found illustrations of parts similar in appearance and, to some extent, component parts that go together in the same subdivisions of the mechanism.

Price List of Parts Turning from the plates to the price list, the description of each part and its principal uses will be found to give all necessary information. Where a part is used on all machines, no specific use is mentioned in the description. The screw or screws belonging to each part are repeated after its description. If two or more parts in a group have the same general description and use the same screws, the screws are only specified after the last part in the group.

(—) A dash in the "Plate number" column of the price list indicates the absence of an illustration.

(‡) A double dagger in the "Number to order by" column indicates that the component parts cannot be furnished separately.

(*) A star in the "Number to order by" column indicates that the part can only be furnished upon the return of the broken or worn out part. This rule we are forced to adopt because of the difficulty of protecting our customers and ourselves against improper use of these particular parts, which, like others, are furnished at list prices for repairs only.

Ordering Goods A large number of parts have their full numbers stamped upon them. Other parts, difficult to distinguish, are marked instead with identification letters.

If customers furnish the number stamped on a piece, errors will be avoided and we shall be enabled promptly to duplicate the desired part. If only an identification letter is furnished, it should be accompanied with a general description of the part.

All part numbers represent the same part regardless of the catalog in which they appear.

All supplies, including oil, belting, belt hooks, malleable iron belt lacings, taps, reamers, screw drivers and powdered oilstone, will be promptly furnished.

Terms Attention is directed to our established practice. Prices on all parts and supplies are strictly net. Being shipped in perfect condition, packed with skillful care, they are forwarded at the buyer's risk, f. o. b., Chicago. Regular postage rates will be charged on all goods sent by mail.

PLATE NO. 1—Full Size.

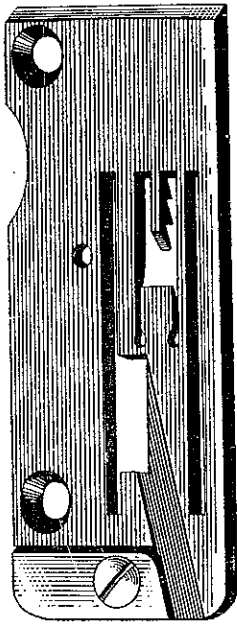

6924 A

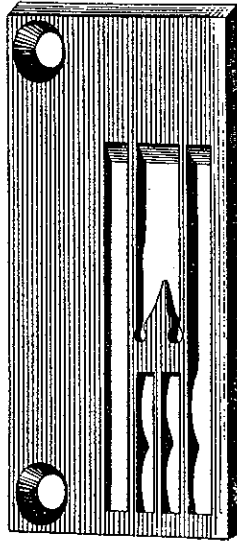

10324 B

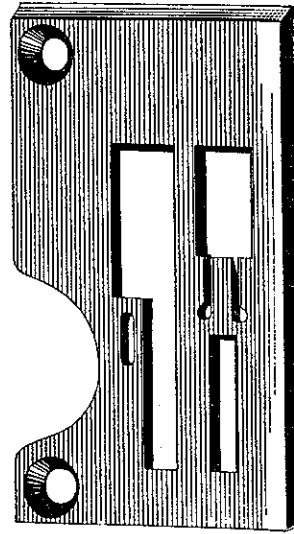

12724

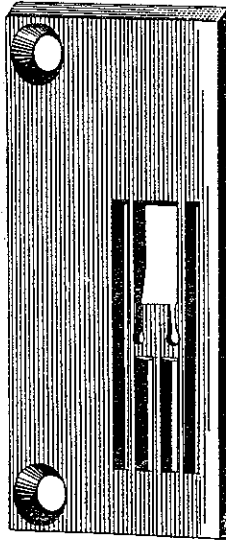

6924 H

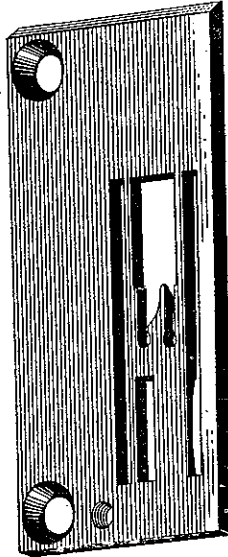

10324 A

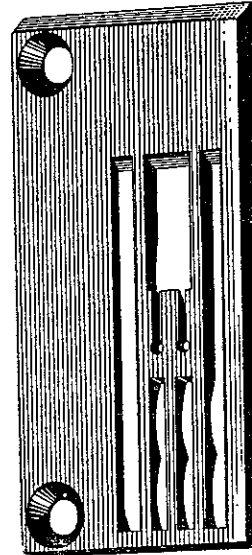

10324 F

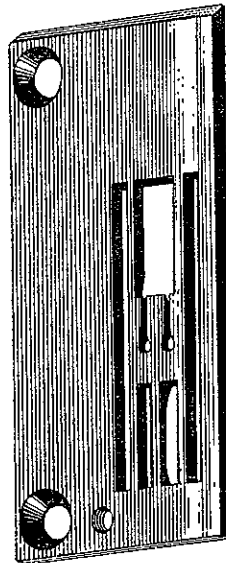

112 D N

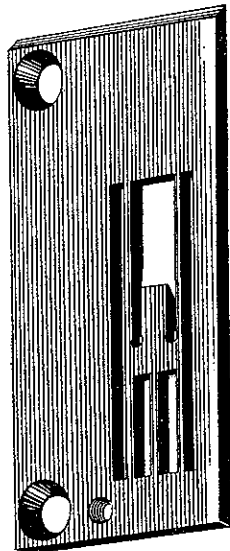

6924 E

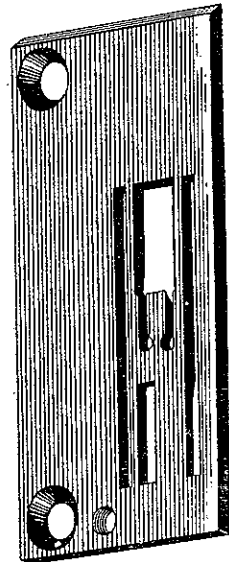

10324

PLATE No. 2 - Full Size.

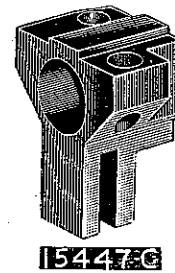
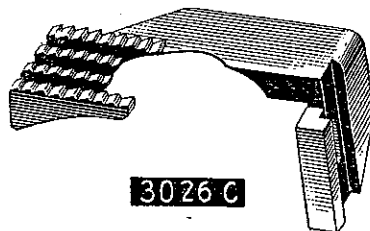
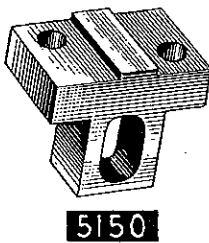
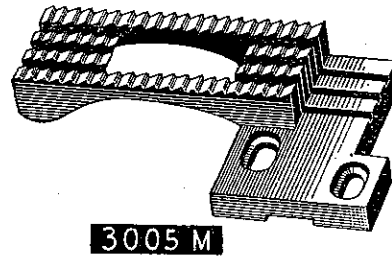
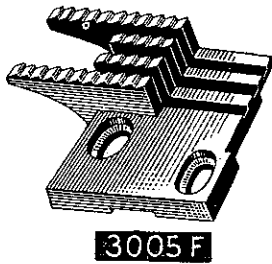
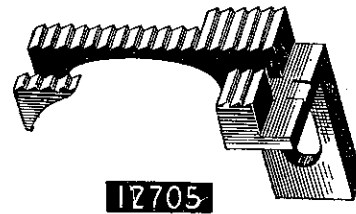
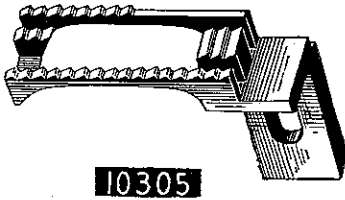
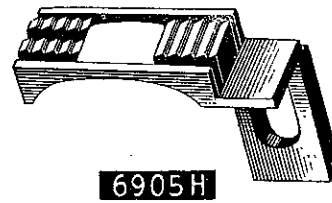
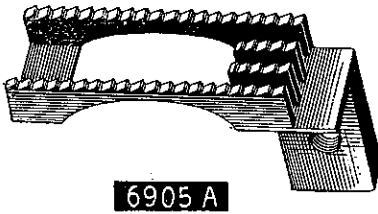
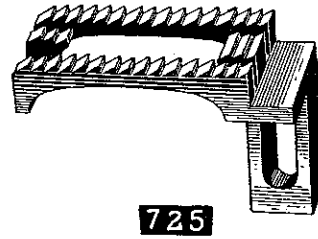
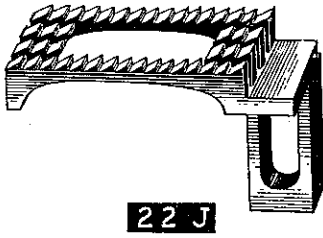
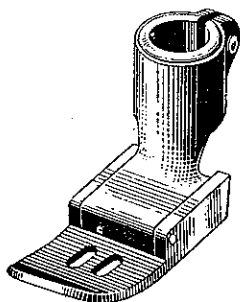
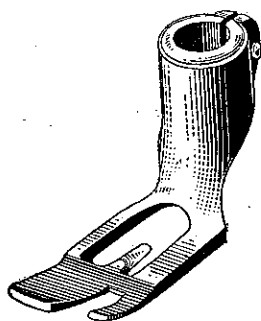

PLATE NO. 3 Full Size.



65 DN



738

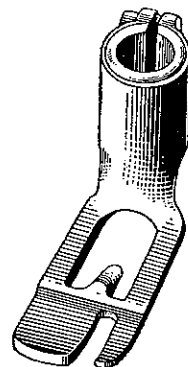

738 A

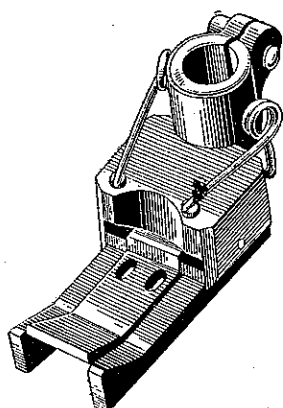

6920 A

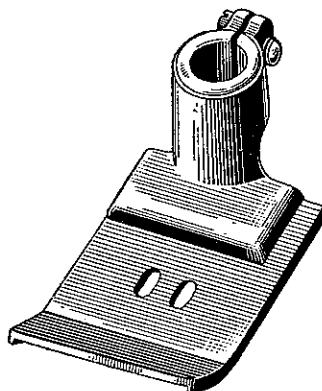

6920 C

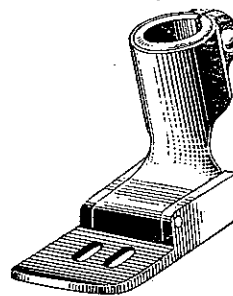

6920 E

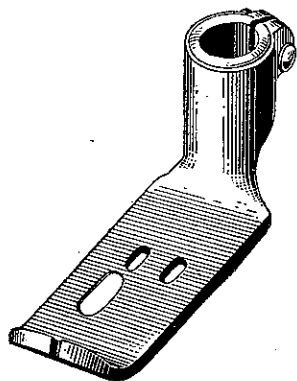

6920 B



5125



6990

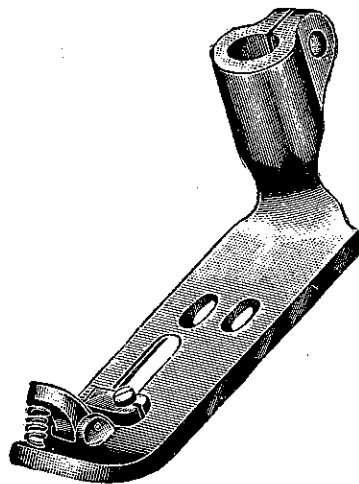

6927 A

PLATE No. 4--Full Size.

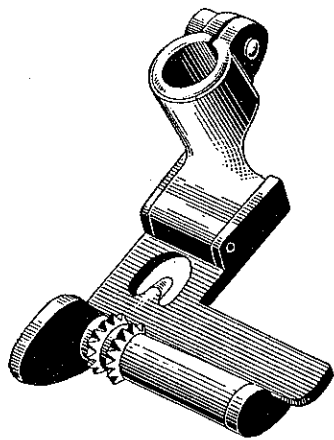

10320 B

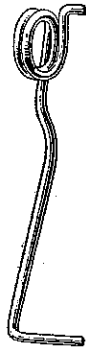

15480 C

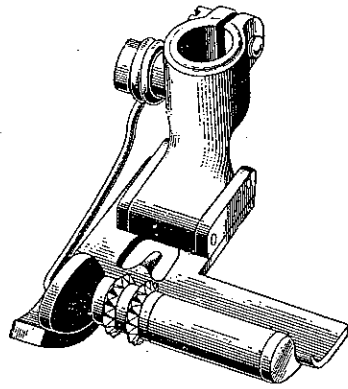

10320 F

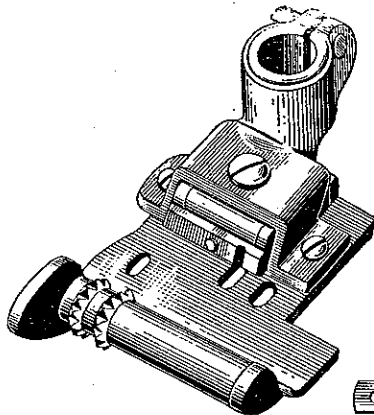

12720 A



6954 B

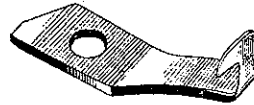

6955 A

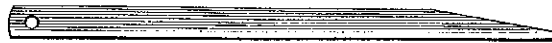

6954 A



14



1361



1362



1588



15446 C

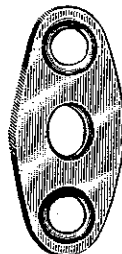

15447 B

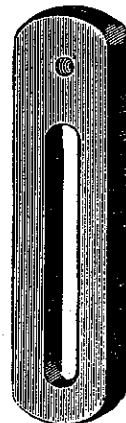

16198

PLATE NO. 5—Full Size.

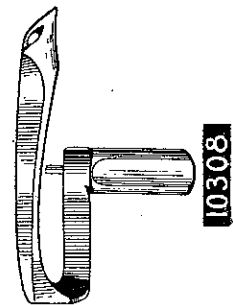
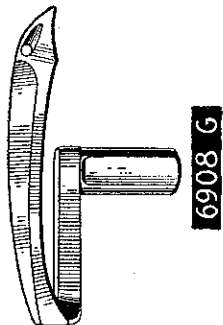
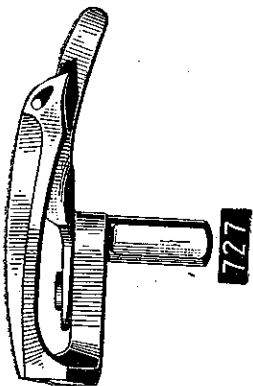
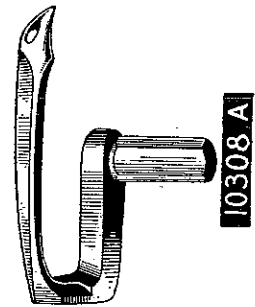
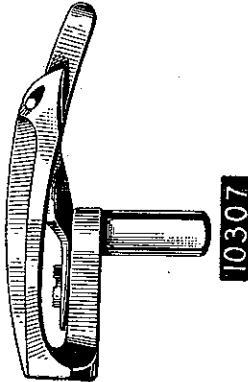
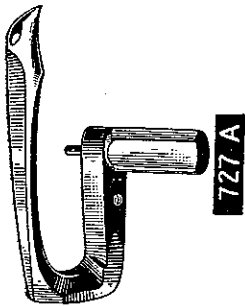
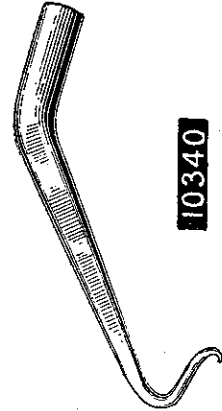
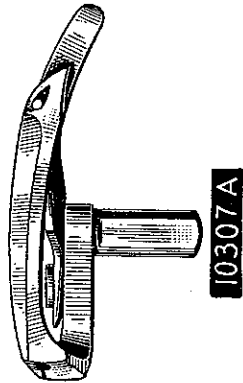
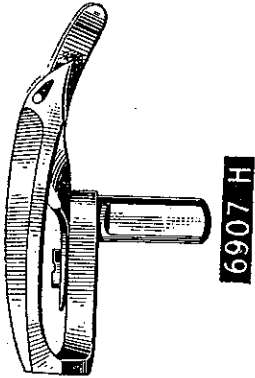
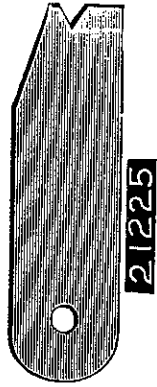
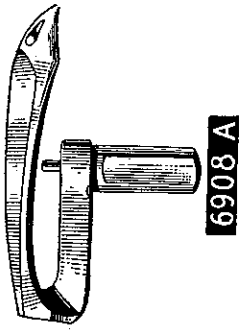
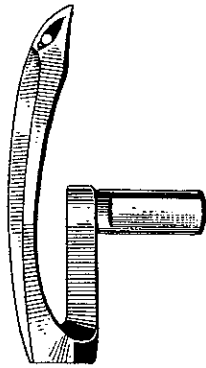
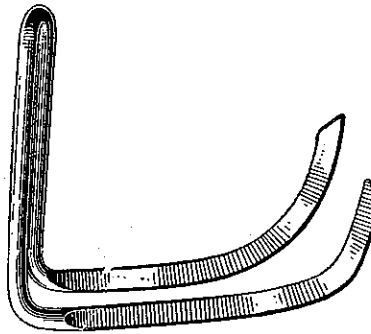

PLATE No. 6—Full Size.



12708-36-12



6904

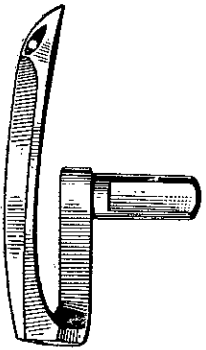

12708-32-12

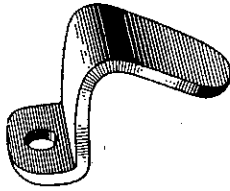

3072

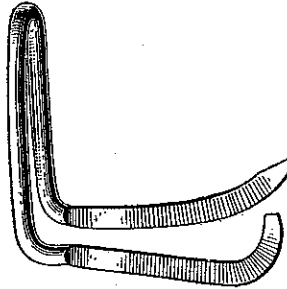

12704

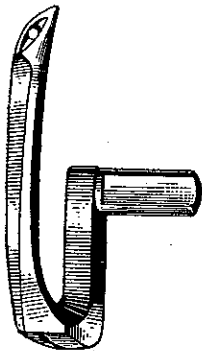

12708-30-12

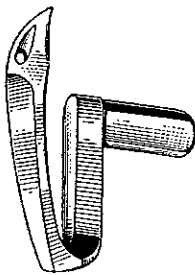

12709 A-36-12

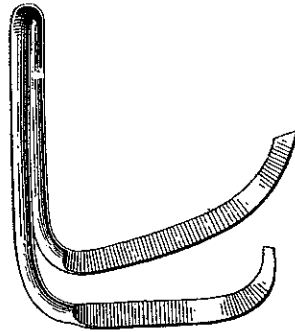

4 D

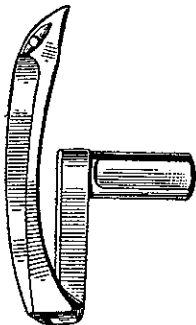

12708-24-12

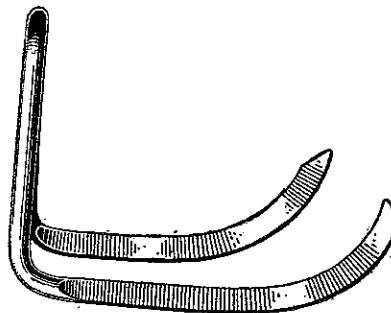

3004

PLATE NO. 7—Full Size.

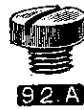
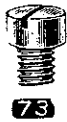

PLATE No. 8—Full Size.



25C



93 A



94



93

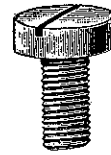

135

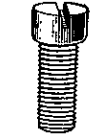

22516



22517



22529



57 WD



92

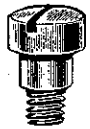

86



86.A



97 A



134



80



87



22521



22524



22525



22526



79

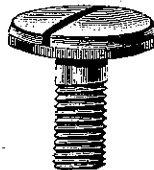

141



82



75



22569



75.A

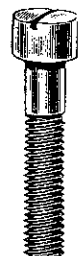

85



136



22522



22587

PLATE No. 9—Full Size.



42.A



6948 D



128 D

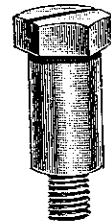

12934 B

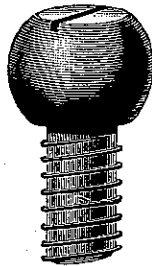

156



10349

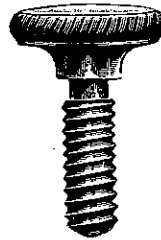

2010



9675

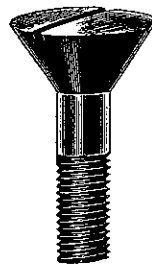

33

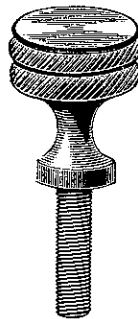

610

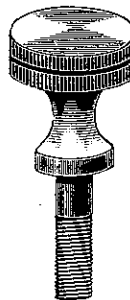

626

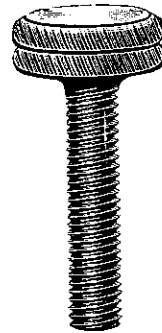

64.A

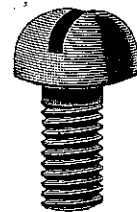

616



629



260

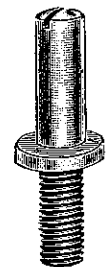

154-47 A

PLATE No. 10—Full Size.



1B



34



37L



37R



47



64B



269



462

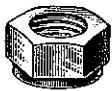

1280

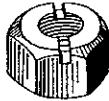

544



907

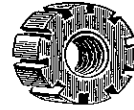

T6



6956 D

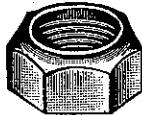

15430 C

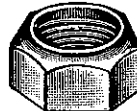

15430 D



15430 H



20



4B



129



15430 K



2120



2121



34A



84B



6967 F

PLATE NO. 11—Full Size.



1347

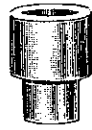

11261 B



11261 A



15492



109



108

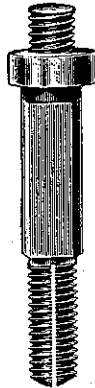

105



105 A



1346



486

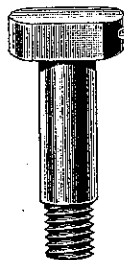

17



6939



6042

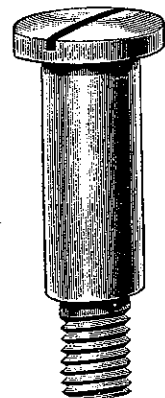

420

PLATE No. 12—Full Size.

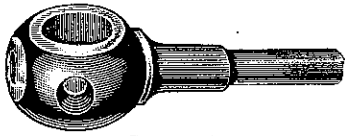

61 C

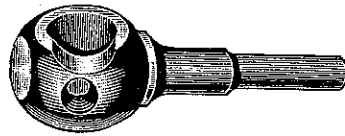

61 X

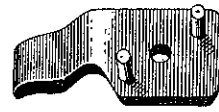

6956 B

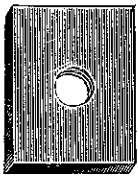

14675



6967 C

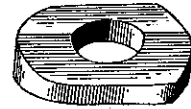

10350

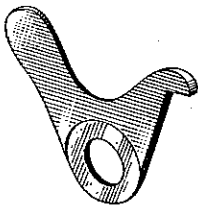

6998 P

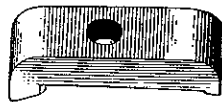

6998 Q



6998 R

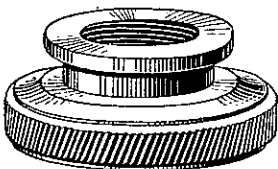

G 20

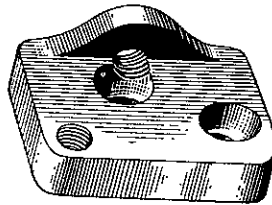

6998 N

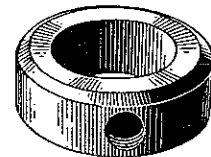

G 23

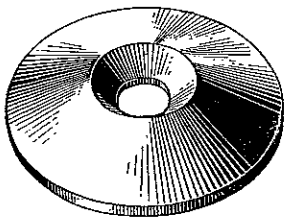

G 28

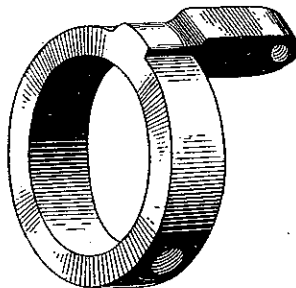

6998 M

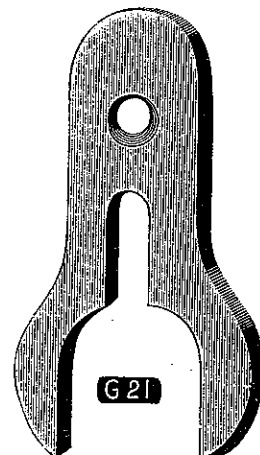

G 21

PLATE No. 13—Full Size.



110-1

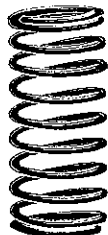

110-2



110-3



110-4



1349



3336



10342



1286 B



67



6956 C

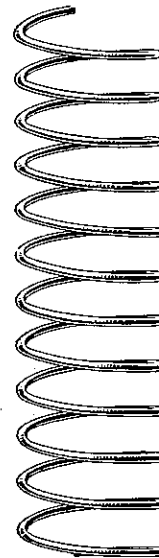

622



57 WC



1290



540



6956 E



12873

12964 C

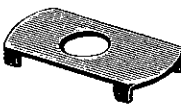

57-W.E

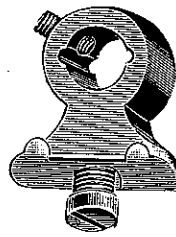

1287

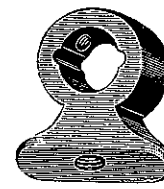

1288

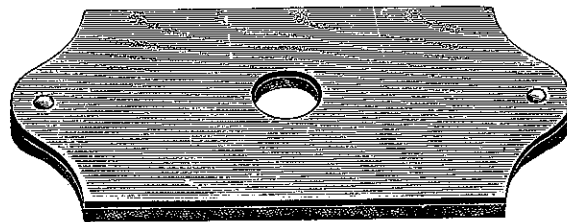

1007



1008

PLATE No. 14—One-half Size.

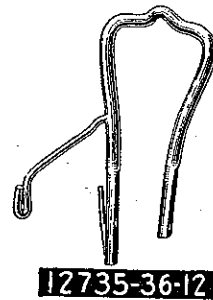
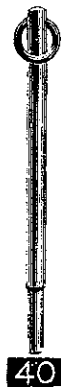
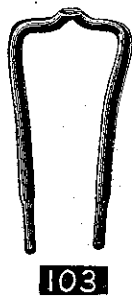
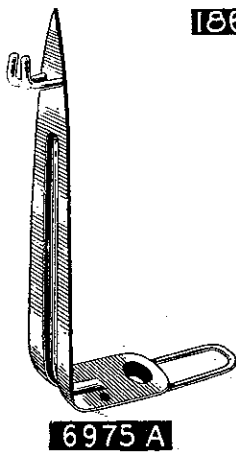
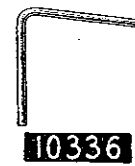
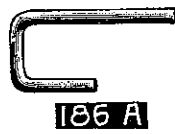
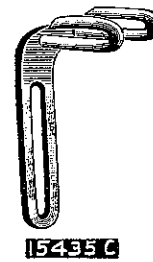
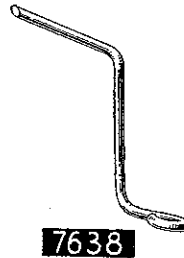
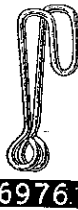
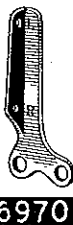
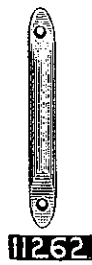

PLATE NO. 15—One-half Size.

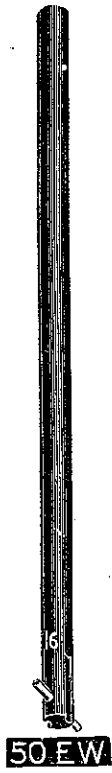

PLATE No. 16—One-half Size.



139A



10341



14544



12935



10356



6036



6037



6933



6934



10345

PLATE No. 17 - One-half Size.

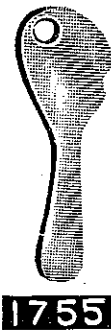
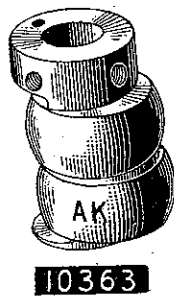
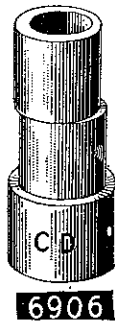
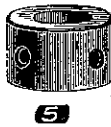

PLATE No. 18—One-half Size.



36.L



36.R

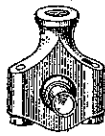

6038



6039



64

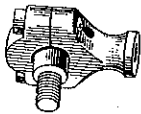

10347

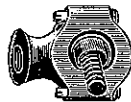

10357

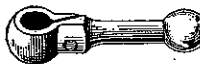

10344

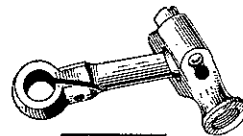

10346



54



54 A

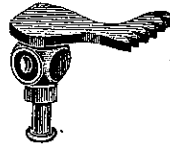

142.C

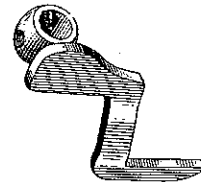

10343

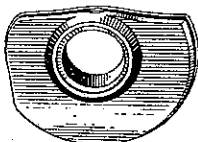

101



162



1275

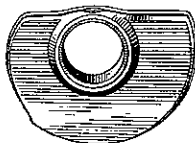

101 V

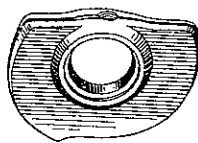

3023

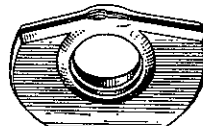

6923 G

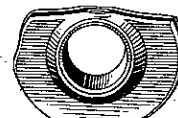

12723

PLATE No. 19—One-half Size.

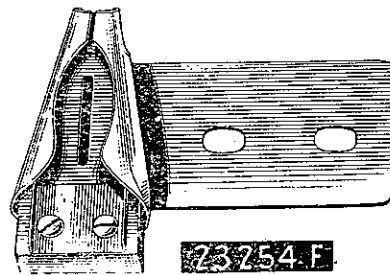
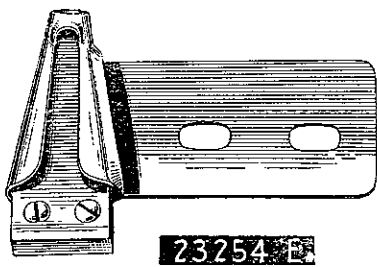
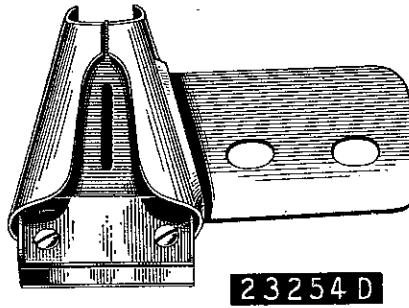
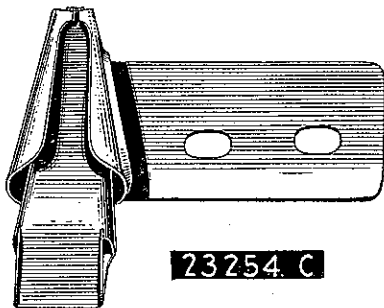
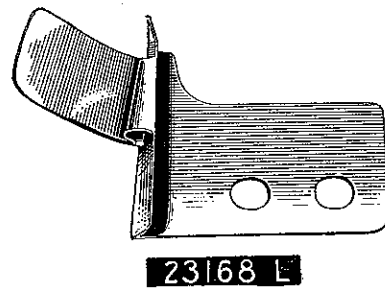
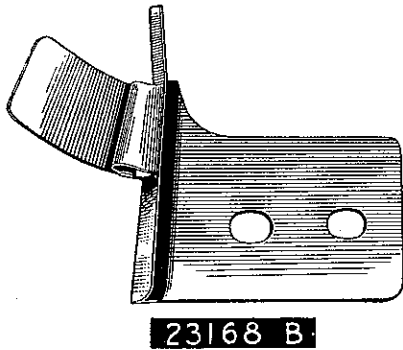
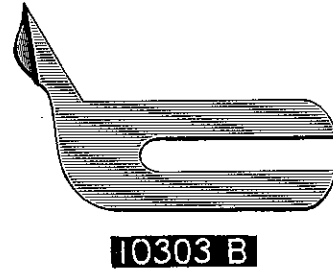
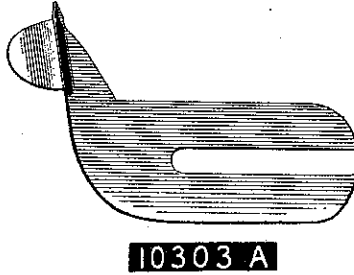
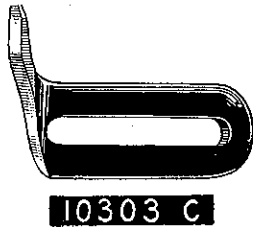
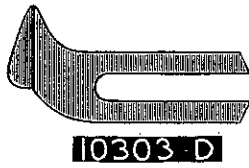
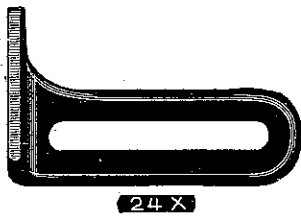

PLATE No. 20--One-half Size.



6 B



23



154

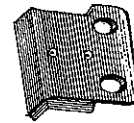

15447 H



13



57



58



104

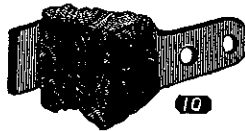

10



70

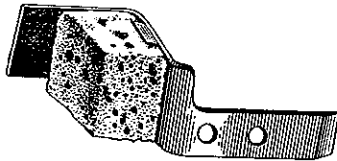

15447 G



21390 E



21390 A



21390 B



21390 D



21390 F

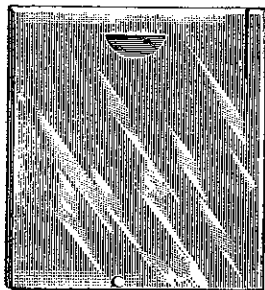

2

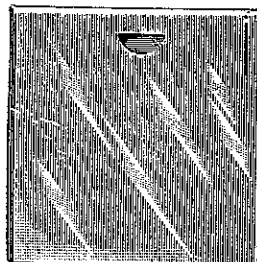

2.A

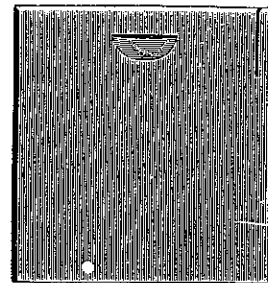

2CU

PLATE No. 21--One-half Size.



6948 A



6956 A

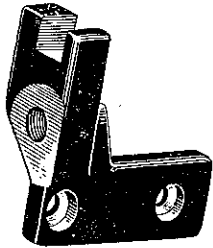

6948 C

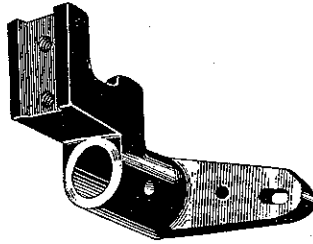

6948 B

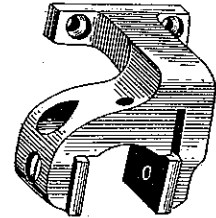

6968

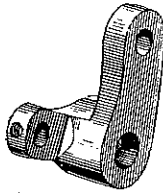

6937

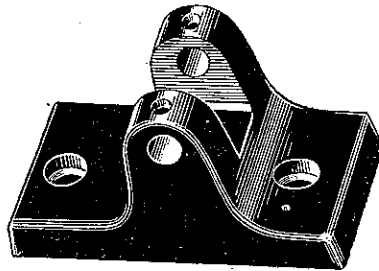

6938

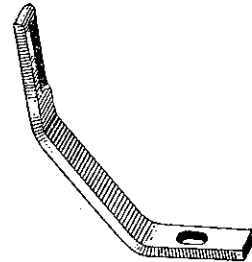

6967 B

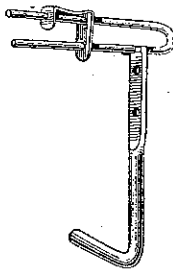

10339

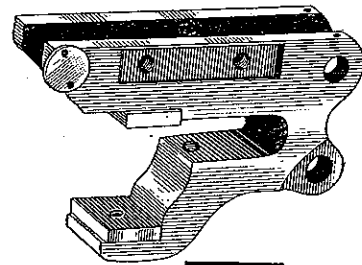

6967

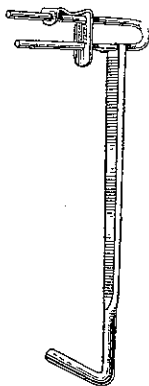

12741

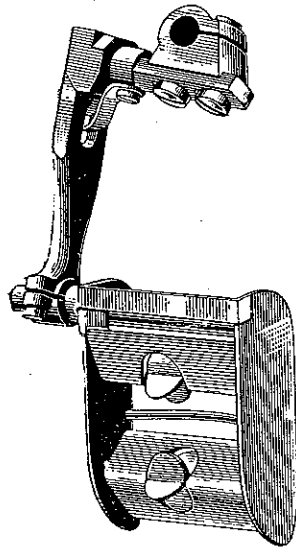

12750

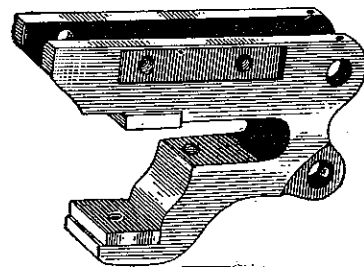

6967 D

PLATE No. 22—One-half Size.

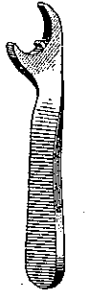

T24



21388

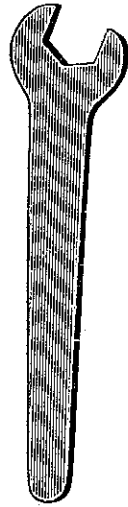

21388-B



118 B



118



21350



21350 A

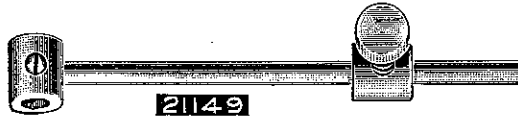

21149

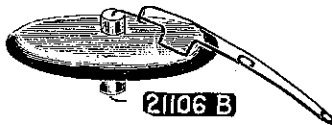

21106 B

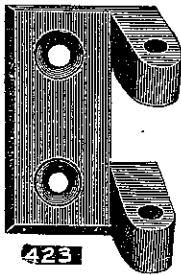

423



1005



426

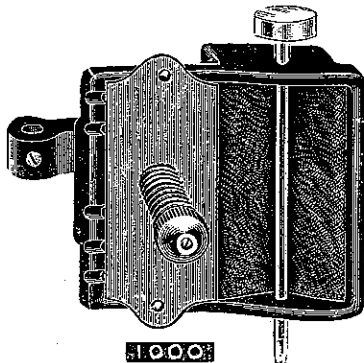

1000

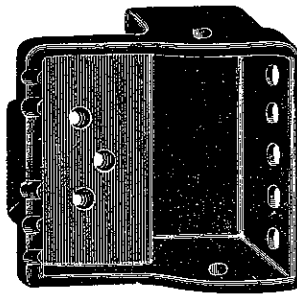

1002



1003

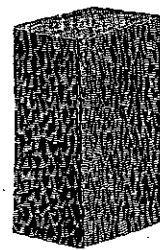

1004

PLATE No. 23—One-third Size.

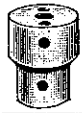

21102 A-2

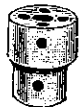

21102 A-4



168



168 B

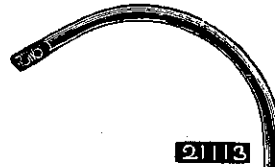

2113

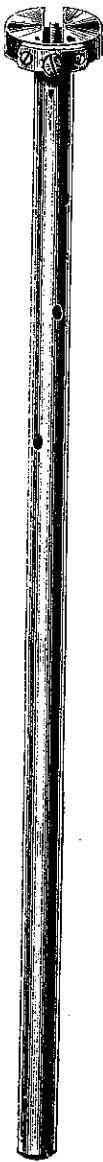

169



10322

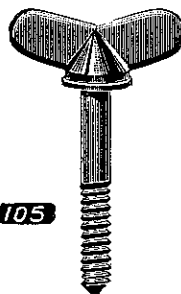

105



100 B

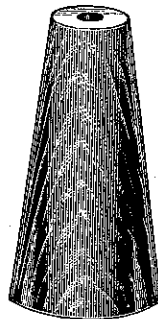

21145

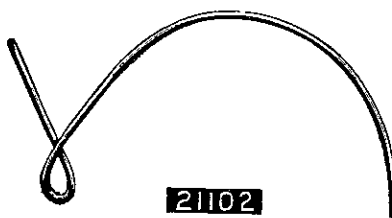

21102

PLATE No. 24 - One-third Size.

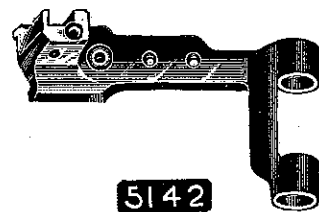
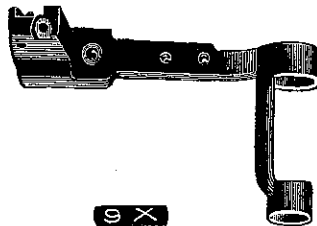
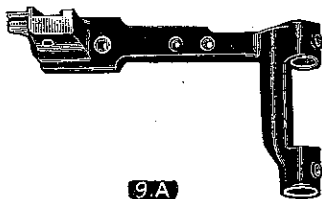
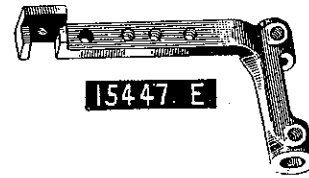
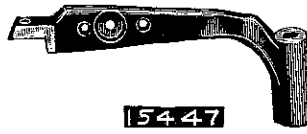
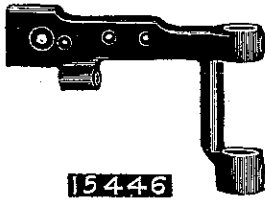
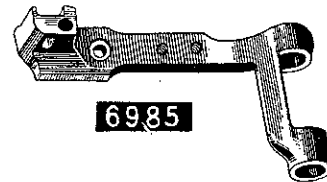
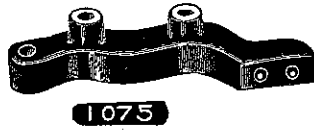
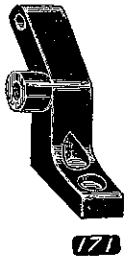
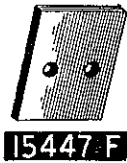
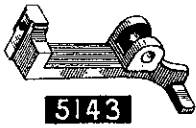

PLATE No. 25—One-third Size.



15



295



213



183



15430E

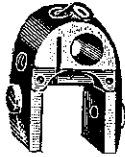

6A

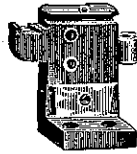

102



15430L



15430F

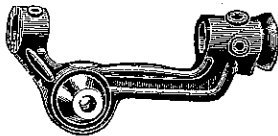

30

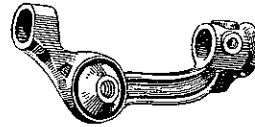

6932

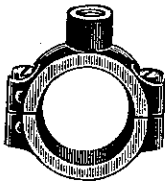

15430



10364

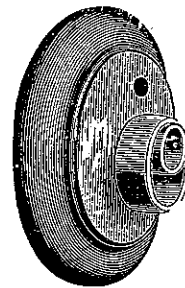

595

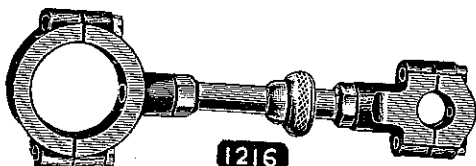

1216

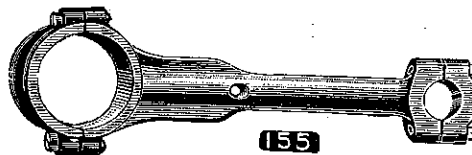

155

PLATE No. 26—One-fourth Size.

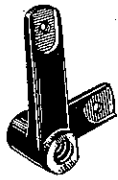

10348



10359

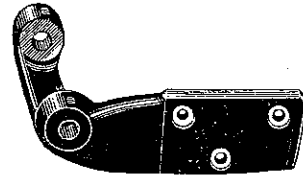

10360

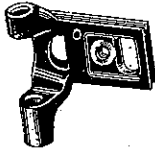

10352

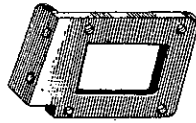

10353



10354



10355

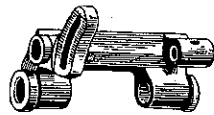

5156

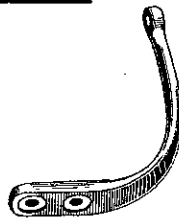

5157

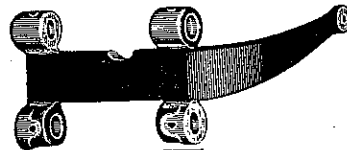

7



G 11



G 19



G 27



6998 T

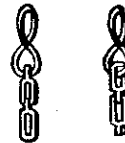

421



6998 H



6998 J



6998 S

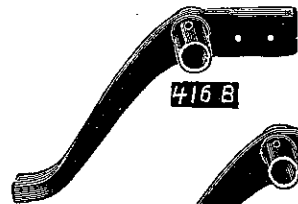

416 B



416 A

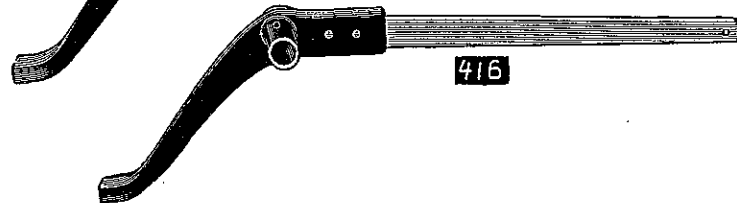

416



8646



8645



8647

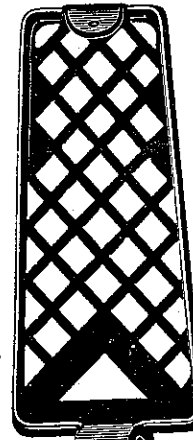

422

PLATE No. 27—One-eighth Size.

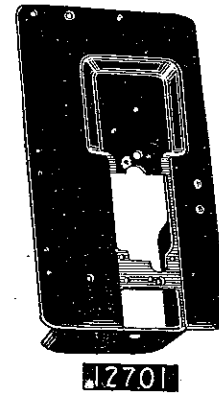
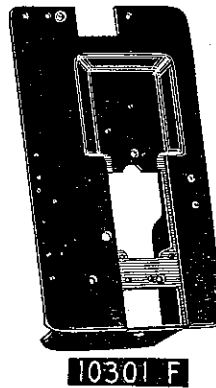
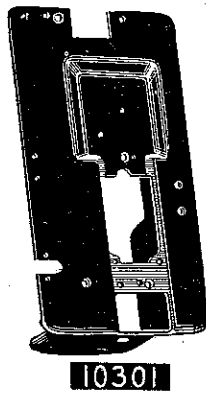
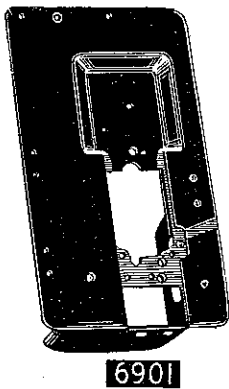
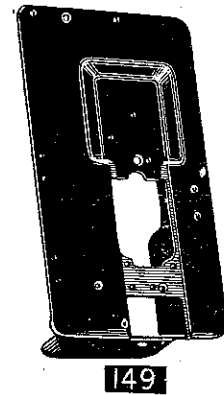
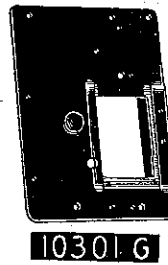
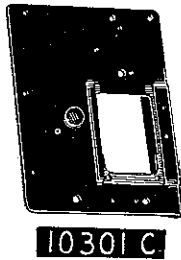
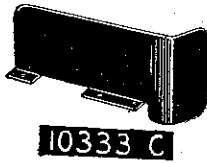
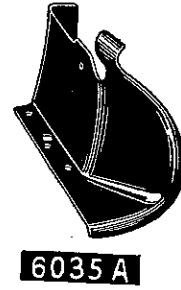
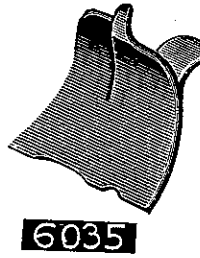
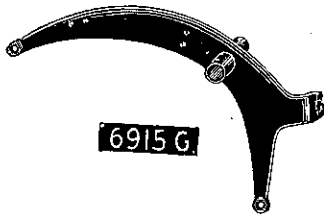
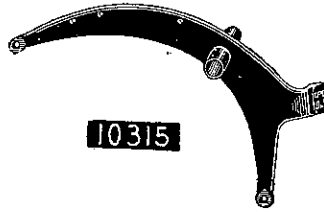
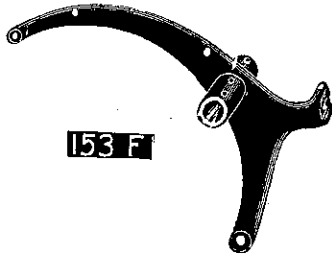
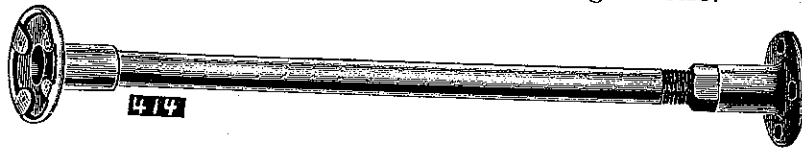

PLATE No. 28—One-eighth Size.

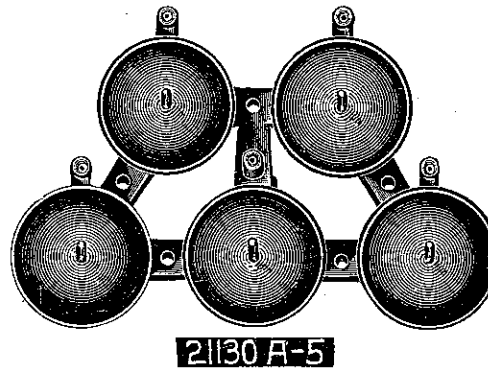
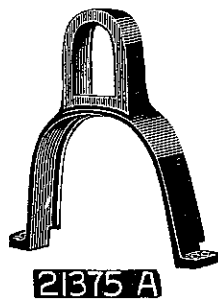
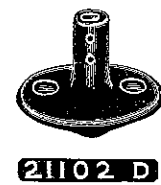
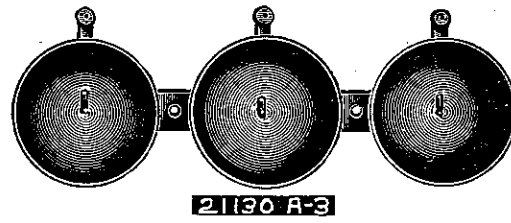
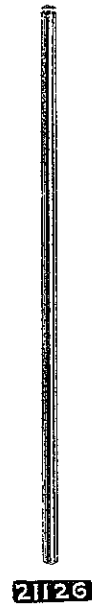
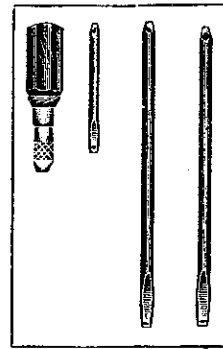
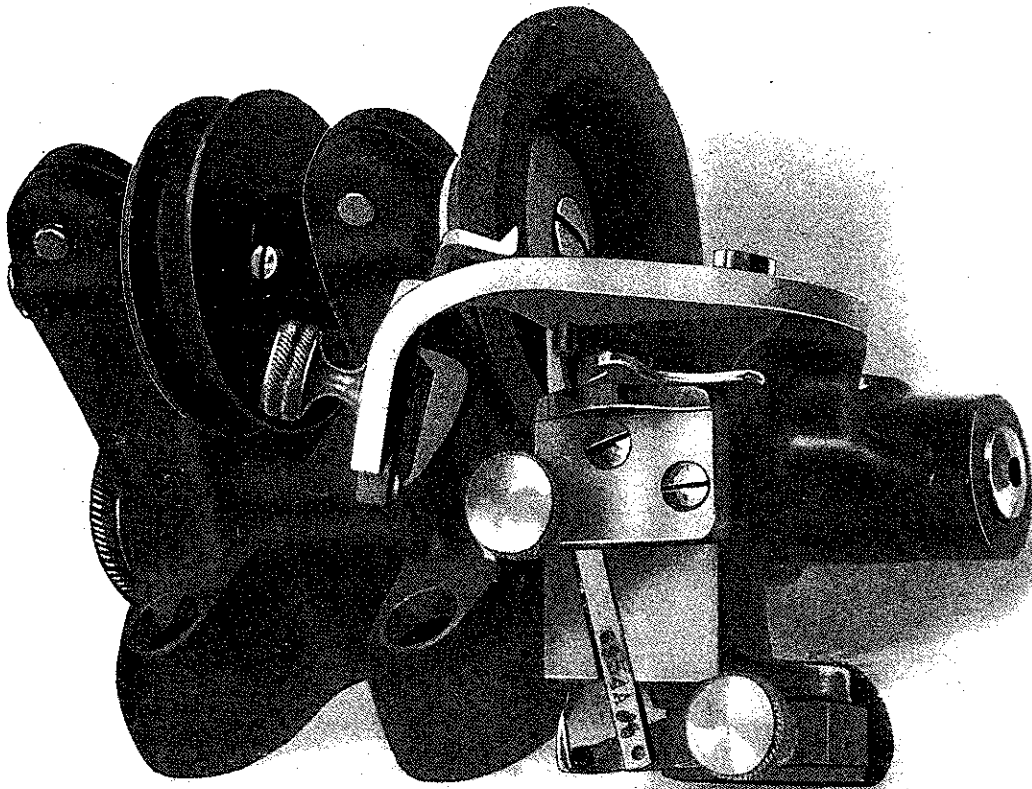

PLATE No. 29—TWO-THIRDS SIZE.



6998 G—KNIFE GRINDER.

PRICE LIST OF PARTS

[2-G11]

THESE PARTS ARE FURNISHED AT LIST PRICES FOR REPAIRS ONLY.
SEE NOTICE ON PAGE 3.

| Number to order by | Plate No. | Postage will be charged on all parts sent by mail. Figures in second column refer only to plates illustrating parts, and are not to be used in ordering. Prices subject to change without notice. TERMS ON PARTS, NET CASH | Price per part |
|-----------------------|--------------|--|----------------------|
| 2 | 20 | Cloth Plate Slide, right ($2\frac{9}{16}$ inches long)..... | \$0 40 |
| | | “ “ “ Stop Screw No. 150..... | 04 |
| 2 A | 20 | “ “ “ left..... | 40 |
| 2 CU | 20 | “ “ “ right ($2\frac{5}{16}$ inches long)..... | 40 |
| | | “ “ “ Stop Screw No. 150..... | 04 |
| 4 D | 6 | Cast-off Wire, for use with take-up No. 101 V on ma- chines in Class 10300, also for use with take-up No. 101 on Styles 6900 E and 6900 H..... | 30 |
| | | “ “ Screw No. 87..... | 04 |
| 5 | 17 | Collar, for main shaft..... | 25 |
| | | “ Screws No. 95..... | 03 |
| 6 A | 25 | Looper Eccentric Fork, with shoes..... | 75 |
| | | “ “ “ Clamp Screw No. 85..... | 05 |
| | | “ “ “ Set Screws No. 72..... | 05 |
| 6 B | 20 | “ “ “ Shoe..... | 10 |
| | | “ “ “ Shoe Screw No. 94..... | 04 |
| T6 | 10 | Feed Dog Tilting Rod Check Nut, for tilting feed machines..... | 15 |
| 7 | 26 | Feed Rocker, for machines in Classes 6900 and 12700 and for Styles 10300 B, 10300 C and 10300 D, also for tilting feed machines..... | 1 00 |
| | | “ “ Screws No. 88..... | 03 |
| G7 | 13 | Penetrating Knife Clamp Spring, for knife grinder..... | 04 |
| 8 | 15 | Feed Rocker Shaft ($5\frac{3}{16}$ inches long, hardened and ground) sizes .407, .408, .410, .413 and .416..... | 45 |
| 9 A | 24 | Feed Bar, for Style 6900 E..... | 75 |
| 9 X | 24 | “ “ for machines in Class 12700..... | 50 |
| | | “ “ Screws No. 88..... | 03 |
| 10 | 20 | “ “ Prong and Sponge, for machines in Classes 6900 and 12700 and for Styles 10300 B, 10300 C and 10300 D, also for tilting feed machines..... | 20 |
| | | “ “ Prong Screws No. 94..... | 04 |
| 10 A | — | “ “ Prong Sponge..... | 02 |
| G10 | 9 | Thumb Screw (length $\frac{1}{2}$ inch) for penetrating knife swinging frame clamp No. 6998 Q..... | 15 |
| 11 | 15 | Feed Bar Shaft ($3\frac{7}{16}$ inches long, hardened and ground) sizes .407, .408 and .410..... | 40 |
| G11 | 26 | Pulley, for knife grinder..... | 50 |
| | | “ Screws No. 98..... | 03 |

[12-28C]

PRICE LIST OF PARTS

THESE PARTS ARE FURNISHED AT LIST PRICES FOR REPAIRS ONLY.
SEE NOTICE ON PAGE 3.

| Number to order by | Plate No. | Postage will be charged on all parts sent by mail. Figures in second column refer only to plates illustrating parts, and are not to be used in ordering. Prices subject to change without notice. | Price per part |
|--------------------------|-----------|---|----------------|
| TERMS ON PARTS, NET CASH | | | |
| 12 | 27 | Feed Crank Cover | \$0 30 |
| 13 | 20 | " " " Spring..... | 10 |
| | | " " " Spring Screw No. 94..... | 04 |
| G13 | 9 | Pulley Spindle Clamp Screw, for knife grinder..... | 03 |
| 14 | 4 | Feed Crank Cover Hinge Screw..... | 10 |
| 15 | 25 | " " Link (hardened)..... | 40 |
| | | " " Link Screw No. 79..... | 04 |
| 16 | 17 | " " Link Ferrule (hardened and ground)..... | 30 |
| 17 | 11 | " " Stud..... | 25 |
| 18 | 10 | " " Stud Nut, also for Nos. 36 R, 6039, 10347, 10349 and 10357..... | 10 |
| 19 | 14 | " " Stud Cap..... | 15 |
| | | " " Stud Cap Screws No. 77..... | 03 |
| G19 | 26 | Swinging Frame Pivot Pin Sleeve, for knife grinder..... | 60 |
| 20 | 10 | Feed Crank Stud Washer ($\frac{7}{32}$ -inch hole)..... | 03 |
| G20 | 12 | Swinging Frame Pivot Pin Adjusting Nut for knife grinder | 35 |
| 21 | 17 | Feed Crank Link Pin (hardened and ground) also for No. 6956 A..... | 10 |
| | | " " Link Pin Screw No. 77..... | 03 |
| G21 | 12 | Swinging Frame Pivot Pin Adjusting Nut Guide, for knife grinder..... | 35 |
| | | " " " " Adjusting Nut Guide Screw No. 87..... | 04 |
| 22 J | 2 | Feed Dog, for Nos. 8 and 12 gauge Style 6900 E..... | 85 |
| | | " " Screw No. 93..... | 04 |
| G22 | 13 | Swinging Frame Pivot Pin Spring, for knife grinder... | 10 |
| 23 | 20 | Feed Bar Shoe (hardened and ground) for machines in Classes 6900 and 12700 and for Styles 10300 B, 10300 C and 10300 D, also for tilting feed machines..... | 15 |
| | | " " " Scre No. 94..... | 04 |
| G23 | 12 | Swinging Frame Pivot Pin Spring Collar, for knife grinder | 15 |
| | | " " " " Spring Collar Screw No. 98... | 03 |
| 24 X | 19 | Cloth Plate Gauge | 20 |
| | | " " " Screws No. 25 C..... | 05 |
| T24 | 22 | Wrench, for feed dog tilting rod check nut..... | 25 |
| 25 C | 8 | Screw ($\frac{9}{32}$ inch long) for cloth plate gauges and attach- ments..... | 05 |
| A26 | 5 | Looper Needle Guard (marked A) for looper No. 6907 H | 15 |
| | | " " " Screw No. 73 A..... | 05 |
| G26 | 9 | Thumb Screw (length $\frac{15}{32}$ inch) for knife clamp No. 6998 R, also for No. 6998 N..... | 15 |
| G27 | 26 | Pulley Spindle (hardened and ground) for knife grinder.. | 75 |
| 28 C | 7 | Side Pressure Screw, for presser feet in Class 12700..... | 03 |

PRICE LIST OF PARTS

[G28-48]

THESE PARTS ARE FURNISHED AT LIST PRICES FOR REPAIRS ONLY.
SEE NOTICE ON PAGE 3.

| Number to order by | Plate No. | Postage will be charged on all parts sent by mail. Figures in second column refer only to plates illustrating parts, and are not to be used in ordering. Prices subject to change without notice. | Price per part |
|--------------------------|-----------|---|----------------|
| TERMS ON PARTS, NET CASH | | | |
| G28 | 12 | Pulley Spindle Washer, for knife grinder..... | \$0 25 |
| * 29 S | 25 | Looper Rocker (hardened) for Style 6900 G..... | 1 00 |
| G29 | 9 | Pulley Spindle Washer Screw, for knife grinder..... | 10 |
| 30 | 25 | Looper Rocker Frame (hardened) for machines in Classes 10300 and 12700, also for Styles 6900 E and 6900 H..... | 1 00 |
| | | “ “ “ Screw, left, No. 88..... | 03 |
| | | “ “ “ Screw, right, No. 98..... | 03 |
| | | “ “ “ Spot Screw, No. 96..... | 03 |
| 31 | 15 | Looper Rock Shaft (3 $\frac{1}{8}$ inches long, hardened and ground) sizes .407, .408, .410, .413 and .416, also for No. 10360..... | 45 |
| 32 | 17 | “ “ “ (1 $\frac{1}{8}$ inches long, hardened and ground) sizes .407, .408, .410, .413 and .416..... | 30 |
| 33 | 9 | Looper Rocker Stud (hardened)..... | 35 |
| 34 | 10 | “ “ “ Nut..... | 10 |
| ‡ 36 L | 18 | Looper Connection Rod Ball Joint, left, complete, for use with Nos. 6036 and 6933..... | 1 25 |
| ‡ 36 R | 18 | “ “ “ Ball Joint, right, complete, for use with Nos. 6036 and 6933..... | 1 25 |
| | | “ “ “ Ball Joint Screws No. 97 A.... | 04 |
| 37 L | 10 | “ “ “ Nut, left thread, for use with Nos. 6036, 6933, 10345 and 10356..... | 10 |
| 37 R | 10 | “ “ “ Nut, right thread, for use with Nos. 6036, 6933, 10345 and 10356..... | 10 |
| 38 | 17 | Looper Eccentric (ground, marked D. eccentricity, .208 inch) for Style 6900 E..... | 50 |
| 38 V | 17 | “ “ (ground, marked V, eccentricity .174 inch) for machines in Class 12700 and for Style 6900 H..... | 50 |
| | | “ “ Screw No. 96..... | 03 |
| 39 | 14 | Lower Tension Arm Thread Guide, for Style 12700 A.... | 05 |
| 40 | 14 | “ Thread Eyelet..... | 10 |
| 41 A | 17 | Presser Foot Lifter (hardened) for machines in Classes 10300 and 12700, also for Styles 6900 E and 6900 H..... | 30 |
| | | “ “ “ Screw No. 86..... | 05 |
| 42 A | 9 | “ “ “ Screw Pin (hardened)..... | 10 |
| 43 | 17 | Feed Lift Eccentric (ground, marked F)..... | 40 |
| | | “ “ “ Screw No. 96..... | 03 |
| 47 | 10 | Needle Lever Stud Nut (hardened)..... | 20 |
| 48 | 10 | “ “ “ Washer ($\frac{7}{16}$ -inch hole)..... | 03 |

‡ *See page No. 13

PRICE LIST OF PARTS

THESE PARTS ARE FURNISHED AT LIST PRICES FOR REPAIRS ONLY.
SEE NOTICE ON PAGE 3.

| Number to order by | Plate No. | Postage will be charged on all parts sent by mail. Figures in second column refer only to plates illustrating parts, and are not to be used in ordering. Prices subject to change without notice. TERMS ON PARTS, NET CASH | Price per part |
|--------------------|-----------|---|----------------|
| *50 EW | 15 | Needle Bar (hardened and ground) sizes .257, .260, .263, .266, .270, .273, .276, .280 and .283, for No. 16 gauge Style 6900 H | \$1 50 |
| | | Needle Bar Set Screws No. 88 | 03 |
| 52 A | 14 | Needle Lever Thread Eyelet, left, for machines in Class 10300, also Frame Thread Eyelet, for machines using needle thread intermittent nipper springs | 10 |
| | | " " Thread Eyelet and Frame Thread Eyelet Screw No. 98 A | 04 |
| 54 | 18 | Needle Bar Link (hardened) also for Nos. 6967 and 6967 D | 75 |
| 54 A | 18 | Differential Rocker Link (hardened) for Style 6900 G | 90 |
| 56 AW | 17 | Needle Clamp Collar, for No. 16 gauge Style 6900 H | 40 |
| 56 C | 17 | " " " Pin, for No. 732 A | 04 |
| 56 CA | 17 | " " " Pin, for No. 56 AW | 04 |
| 57 | 20 | Looper Thread Nipper Spring, upper | 10 |
| | | " " " " Screw No. 99 | 04 |
| 57 WB | 13 | Needle Bar Thread Nipper Plate | 05 |
| 57 WC | 13 | " " " " Spring (.011-inch diameter wire) | 03 |
| 57 WD | 8 | " " " " Stud, also for No. 15480 C | 05 |
| 58 | 20 | Looper Thread Nipper Spring, lower | 08 |
| | | " " " " Screw No. 90 | 04 |
| | | " " " " Operating Screw No. 97 | 04 |
| 59 S | 25 | Eccentric Pulley (marked M) | 2 00 |
| | | " " Screws No. 22597 | 03 |
| 60 A | 15 | Presser Bar (hardened and ground) sizes .319, .322, .325, .328, .331 and .334, for Style 6900 E | 75 |
| 60 X | 15 | " " (hardened and ground) sizes .319, .322, .325, .328, .331 and .334, for machines in Classes 10300 and 12700, also for Styles 6900 G and 6900 H | 75 |
| 61 C | 12 | Presser Bar Connection, for Style 6900 E | 35 |
| | | " " " Screw, front, No. 77 | 03 |
| | | " " " Screws, back, No. 88 | 03 |
| 61 X | 12 | " " " for machines in Classes 10300 and 12700, also for Styles 6900 G and 6900 H | 35 |
| | | " " " Screw, front, No. 89 | 03 |
| | | " " " Screw, back, No. 77 | 03 |

*See Page No. 13

PRICE LIST OF PARTS

162- 87 U

THESE PARTS ARE FURNISHED AT LIST PRICES FOR REPAIRS ONLY.
SEE NOTICE ON PAGE 3.

| Number to order by | Plate No. | Postage will be charged on all parts sent by mail. Figures in second column refer only to plates illustrating parts, and are not to be used in ordering. Prices subject to change without notice. TERMS ON PARTS, NET CASH | Price per part |
|--------------------|-----------|---|----------------|
| 62 | 15 | Presser Guide Bar (hardened and ground) sizes .319, .322, .325, .328, .331 and .334, for machines in Classes 10300 and 12700, also for Styles 6900 G and 6900 H..... | \$0 40 |
| 62 A | 15 | Presser Guide Bar (hardened and ground) sizes .319, .322, .325, .328, .331 and .334, for Style 6900 E..... | 40 |
| 64 | 18 | Presser Spring Rest, for Style 6900 G..... | 50 |
| | | “ “ “ Screw No. 88..... | 03 |
| 64 A | 9 | Presser Spring Screw Regulator..... | 25 |
| 64 B | 10 | “ “ “ Regulator Check Nut..... | 10 |
| 65 DN | 3 | Presser Foot, for No. 8 gauge Style 6900 E..... | 1 25 |
| | | “ “ Screw No. 91..... | 04 |
| 67 | 17 | Main Shaft Sleeve ($1\frac{1}{16}$ inches long)..... | 12 |
| 68 | 17 | “ “ “ ($1\frac{11}{16}$ inches long)..... | 15 |
| 69 S | 28 | Spool Pin (four inches long) for Style D thread stand... | 10 |
| 70 | 20 | Looper Eccentric Sponge Holder and Sponge..... | 10 |
| | | “ “ Sponge Holder Screw No. 94..... | 04 |
| 70 A | — | “ “ Sponge..... | 02 |
| 72 | 7 | Set Screw, for looper eccentric fork..... | 05 |
| 73 | 7 | “ “ for loopers, also for No. 10340..... | 05 |
| 73 A | 7 | Screw, for looper needle guards..... | 05 |
| 75 | 8 | Adjusting Screw, for knife bar on Style 6900 G, also for No. 6998 M..... | 04 |
| 75 A | 8 | Screw, for needle lever connections with non-separable bearings, also for No. 10364..... | 04 |
| 77 | 7 | “ for feed crank stud cap, also for Nos. 21, 61 C, 61 X, 1286 and 6932..... | 03 |
| 78 | 7 | “ lower, for link pins..... | 03 |
| 79 | 8 | “ for feed crank link..... | 04 |
| 80 | 8 | “ for cloth plates, also for No. 10337..... | 05 |
| 81 | 7 | Spot Screw, for spreader eccentric..... | 03 |
| 82 | 8 | Screw, for regulating stitch..... | 08 |
| 84 A | 10 | Stitch Regulating Ferrule ($\frac{7}{32}$ -inch long)..... | 05 |
| 84 B | 10 | “ “ “ ($\frac{5}{32}$ -inch long)..... | 05 |
| 85 | 8 | Clamp Screw, for looper eccentric fork, also for Nos. 6967 and 6967 D..... | 05 |
| 86 | 8 | Screw, for presser foot lifters..... | 05 |
| 86 A | 8 | “ large size, for presser foot lifters (tap No. 21513)..... | 08 |
| 87 | 8 | “ for throat plates, also for Nos. 4 D, G21, 129, 3004, 6904, 12704, 15447 B and 21390 D..... | 04 |
| 87 U | 7 | “ for needle bar thread eyelets, also for Nos. 186 A, 6955 A, 6956 B, 8651, 10336, 10339 and 12741.. | 04 |

PRICE LIST OF PARTS

THESE PARTS ARE FURNISHED AT LIST PRICES FOR REPAIRS ONLY.
SEE NOTICE ON PAGE 3.

| Number to order by | Plate No. | Postage will be charged on all parts sent by mail. Figures in second column refer only to plates illustrating parts, and are not to be used in ordering. Prices subject to change without notice. TERMS ON PARTS, NET CASH | Price per part |
|--------------------|-----------|---|----------------|
| 88 | 7 | Screw, for feed rockers, also for Nos. 9 A, 9 X, 30, 50 EW, 61 C, 64, 161, 730, 730 A, 1288, 2538, 5142, 5156, 5217, 6985, 10343, 12730, 12730 A, 15446 and 15447 E..... | \$0 03 |
| 88 A | 7 | " for thread controller rack and presser spring rest. | 04 |
| 88 B | 7 | Set Screw ($\frac{1}{8}$ inch long) for needles..... | 03 |
| 89 | 7 | Screw, for take-ups, also for Nos. 61 X, 732, 6937 and 12718..... | 03 |
| 90 | 7 | " for looper thread nipper springs, also for Nos. 3072, 6968 and 21390 E..... | 04 |
| 91 | 7 | " fillister head, for presser feet..... | 04 |
| 91 A | 7 | " for side pressure yoke. for presser feet in Class 12700..... | 04 |
| 92 | 8 | Cloth Plate Slide Stop Screw, for Styles 10300 C and 10300 G, also for No. 10333 C..... | 04 |
| 92 A | 7 | Screw, for cloth plate guard No. 10333 C..... | 04 |
| 93 | 8 | " ($\frac{7}{16}$ inch long) for feed dogs, also for Nos. 102, 171, 1002, 1075, 5150, 6035, 6967 B, 15447 F, 15447 H and 16198..... | 04 |
| 93 A | 8 | " fillister head, for cloth plates and for feed dogs on machines with feed bar needle guards, also for No. 416 A..... | 04 |
| 94 | 8 | " for looper eccentric fork shoes, also for Nos. 10, 13, 23, 70, 104, 5125, 7638, 15447 G and 15447 H.. | 04 |
| 95 | 7 | " for main shaft collar, also for Nos. 100 B, 10363, 21113 and 21113 A..... | 03 |
| 96 | 7 | " for looper rocker frame, also for Nos. 38, 38 V, 43, 1054, 6906, 10314, 21102 C, 21102 D and 21102 E..... | 03 |
| 97 | 7 | " for operating looper thread nipper springs, also for Nos. 9 A, 9 X, 103, 5142, 6976, 6985, 10344, 12735, 15446 B and 21390 F..... | 04 |
| 97 A | 8 | " for looper connection rod ball joints, also for Nos. 10346, 10347, 10357 and 10364..... | 04 |
| 98 | 7 | " ($\frac{3}{16}$ inch long) slotted, for needles, also for Nos. G11, G23, 30, 111, 334, 337, 424, 1005, 6932, 7453 and 11262..... | 03 |
| 98 A | 7 | " for needle lever thread eyelets, also for No. 52 A. | 04 |
| 100 B | 23 | Thread Wire (sixteen inches long) for Style C thread stand..... | 10 |
| | | " " Screw No. 95..... | 03 |
| 101 | 18 | Take-up, for use with cast-off wire No. 4 D on Styles 6900 E and 6900 H..... | 75 |

PRICE LIST OF PARTS

[101V-141]

THESE PARTS ARE FURNISHED AT LIST PRICES FOR REPAIRS ONLY.
SEE NOTICE ON PAGE 3.

| Number to order by | Plate No. | Postage will be charged on all parts sent by mail. Figures in second column refer only to plates illustrating parts, and are not to be used in ordering. Prices subject to change without notice. TERMS ON PARTS, NET CASH | Price per part. |
|--------------------|-----------|---|-----------------|
| 101 V | 18 | Take-up, for use with cast-off wire No. 4 D on machines in Class 10300..... | \$0 75 |
| | | “ Screw No. 89..... | 03 |
| 102 | 25 | “ Frame..... | 50 |
| | | “ Frame Screws No. 93..... | 04 |
| 103 | 14 | “ Thread Eyelet, for machines in Classes 6900 and 10300..... | 20 |
| | | “ Thread Eyelet Support Screw No. 97..... | 04 |
| 104 | 20 | “ Thread Eyelet Spring..... | 05 |
| | | “ Thread Eyelet Spring Screw No. 94..... | 04 |
| 105 | 23 | Machine Thumb Screw, 1½, 2½, 3, 3½, 4, 4½, 5, 5½ and 6 inches inclusive..... | 15 |
| 106 | 11 | Tension Post, for thread pad..... | 20 |
| 106 A | 11 | “ Post, solid, lower, for looper thread on machines in Class 12700..... | 25 |
| 107 | 17 | “ Spring Ferrule..... | 06 |
| 108 | 11 | “ Nut..... | 05 |
| 109 | 11 | “ Disc (hardened)..... | 05 |
| 110 | — | Tension Spring: | |
| 110-1 | 13 | “ “ (.026-inch diameter wire) for looper threads..... | 04 |
| 110-2 | 13 | “ “ (.028-inch diameter wire) for needle and looper threads, also for No. 1000..... | 04 |
| 110-3 | 13 | “ “ (.040-inch diameter wire) for needle threads..... | 04 |
| 110-4 | 13 | “ “ (.048-inch diameter wire) for needle threads..... | 05 |
| 111 | 14 | Tension Thread Eyelet, with two eyes (distance between centers of eyes 1 ⁷ / ₁₆ inches)... | 10 |
| | | “ “ “ Screw No. 98..... | 03 |
| 112 DN | 1 | Throat Plate, for No. 8 gauge Style 6900 E..... | 1 25 |
| | | “ “ Screws No. 87..... | 04 |
| 118 | 22 | Thread Hook..... | 05 |
| 118 B | 22 | Thread Tweezers..... | 20 |
| 129 | 10 | Washer, for swinging frame pivot pin on knife grinder... | 10 |
| | | “ Screw No. 87..... | 04 |
| 134 | 8 | Screw, for stationary knife stop on knife grinder..... | 10 |
| 135 | 8 | “ for bell crank lever frame, also for No. 5157..... | 06 |
| 136 | 8 | “ for differential rocker support on Style 6900 G, also for No. 10353..... | 08 |
| 137 | 14 | Thread Controller Thread Eyelet..... | 10 |
| 138 | 7 | “ “ Thread Eyelet Screw..... | 04 |
| † 139 A | 16 | “ “ Lever and Washer, assembled..... | 1 00 |
| 141 | 8 | “ “ Lever Screw, also for No. 6967 D.... | 10 |

† See Page No.

PRICE LIST OF PARTS

THESE PARTS ARE FURNISHED AT LIST PRICES FOR REPAIRS ONLY.
SEE NOTICE ON PAGE 3.

| Number to order by | Plate No. | Postage will be charged on all parts sent by mail. Figures in second column refer only to plates illustrating parts, and are not to be used in ordering. Prices subject to change without notice. | Price per part |
|--------------------------|-----------|---|----------------|
| TERMS ON PARTS, NET CASH | | | |
| 142 C | 18 | Thread Controller Rack and Presser Spring Rest..... | \$0 75 |
| | | " " Rack and Presser Spring Rest Screw No. 88 A..... | 04 |
| 149 | 27 | Cloth Plate, for Styles 6900 E and 6900 H..... | 2 50 |
| | | " " Screws No. 80..... | 05 |
| | | " " Screw, fillister head, No. 93 A..... | 04 |
| 150 | 7 | " " Slide Stop Screw..... | 04 |
| 153 F | 27 | Needle Lever (steel forging) for Styles 6900 E, 6900 H and 12700 A..... | 2 25 |
| 154 | 20 | " " Washer..... | 05 |
| 155 | 25 | Needle Lever Connection, with non-separable bearings.. | 1 35 |
| | | " " Connection Screws No. 75 A..... | 04 |
| 156 | 9 | " " Ball (hardened)..... | 40 |
| 158 | 14 | " " Thread Eyelet, right..... | 10 |
| 158 A | 14 | " " Thread Eyelet, with three eyes..... | 14 |
| 158 B | 14 | " " Thread Eyelet, with two eyes..... | 12 |
| | | " " Thread Eyelet Screw No. 98 A..... | 04 |
| 161 | 17 | Spreader Bar Collar..... | 15 |
| | | " " Collar Screw No. 88..... | 03 |
| 162 | 18 | Needle Bar Connection, sizes .257, .260, .263, .266, .270, .273, .276, .280 and .283..... | 40 |
| 168 | 23 | Presser Spring (.085-inch metal) for machines in Classes 6900 and 12700..... | 35 |
| 168 B | 23 | " " (.065-inch metal) for machines in Class 10300..... | 35 |
| 169 | 23 | Main Shaft (hardened and ground) sizes .530, .531, .533, .536, .539 and .542, for machines in Classes 6900 and 12700..... | 2 50 |
| 170 | 28 | Screw Driver, round steel, diameter $\frac{7}{32}$ inch, length over all nine inches..... | 30 |
| 171 | 24 | Tension Bracket, for Style 12700 A..... | 30 |
| | | " " Screws No. 93..... | 04 |
| * 183 | 25 | Looper Rocker (hardened) for Style 12700 A..... | 1 25 |
| 186 A | 14 | Needle Thread Pull-off Wire ($\frac{9}{16}$ inch wide)..... | 06 |
| | | " " Pull-off Wire Screw No. 87 U..... | 04 |
| 187 A | 7 | Screw, for felt cushion..... | 04 |
| 188 D | 9 | Thumb Screw, for lace edging spool support cone..... | 10 |
| 201 A | 28 | Lace Edging Spool Support Frame..... | 50 |
| 201 C | 9 | " " " Support Frame Pin Thumb Screw... | 10 |
| 202 A | 14 | Needle Thread Pull-off and Take-up Wire Post..... | 35 |
| | | " " " and Take-up Wire Post Screw No. 22529..... | 05 |
| * 213 | 25 | Looper Rocker (hardened) for machines in Class 10300, also for Styles 6900 E and 6900 H..... | 1 00 |

†*See page No. 13

PRICE LIST OF PARTS

[260-730]

THESE PARTS ARE FURNISHED AT LIST PRICES FOR REPAIRS ONLY.
SEE NOTICE ON PAGE 3.

| Number to order by | Plate No. | Postage will be charged on all parts sent by mail. Figures in second column refer only to plates illustrating parts, and are not to be used in ordering. Prices subject to change without notice. TERMS ON PARTS, NET CASH | Price per part |
|--------------------|-----------|---|----------------|
| 260 | 9 | Knife Holder Friction Washer, for knife grinder | \$0 08 |
| 269 | 10 | Nut (left thread) for use with looper connection rods Nos. 6037 and 6934 | 10 |
| 299 | 17 | Differential Rocker Pivot Pin ($1\frac{3}{8}$ inches long, hardened and ground) for Style 6900 G | 20 |
| 330 A | 17 | Main Shaft Sleeve ($\frac{19}{64}$ inch long) | 06 |
| 337 | 14 | Tension Thread Eyelet, with one eye (length over all $1\frac{7}{16}$ inches) | 07 |
| | | " " Eyelet Screw No. 98 | 03 |
| 413 | 28 | Oil Can | 10 |
| 414 | 27 | Table Brace, complete | 1 50 |
| 416 | 26 | Foot Lift Lever, complete | 75 |
| 416 A | 26 | " " Lever Extension | 25 |
| | | " " Lever Extension Screws No. 93 A | 04 |
| 416 B | 26 | " " Lever Casting | 40 |
| 420 | 11 | " " Lever Stud, also for No. 6948 B | 20 |
| 421 | 26 | " " Chain (thirty-eight inches long) also for No. 6948 A | 15 |
| 422 | 26 | Foot Treadle | 20 |
| 423 | 22 | " " Rest | 15 |
| 424 | 17 | " " Pin | 05 |
| | | " " Pin Screw No. 98 | 03 |
| 426 | 22 | Foot Lift Lever Spring | 05 |
| 426 A | 17 | " " " " Pin, also for No. 3336 | 01 |
| 462 | 10 | Knife Bar Carrier Link Stud Nut (hardened) | 20 |
| 486 | 11 | " " " " " (hardened and ground) | 40 |
| 540 | 13 | Guide Pin, for adjustable pull-off frame No. 15435 C | 05 |
| 605 | 7 | Screw, for spring on presser foot No. 6920 A, also for No. 6956 E | 05 |
| 725 | 2 | Feed Dog, for No. 8 gauge Styles 10300 B and 10300 D, also for No. 12 gauge Style 10300 D | 85 |
| | | " " Screw No. 93 | 04 |
| 727 | 5 | Looper, with guard, for Nos. 8 and 12 gauge Style 6900 E | 1 45 |
| 727 A | 5 | " without guard, for Nos. 8 and 12 gauge Style 6900 E | 1 25 |
| | | " Set Screw No. 73 | 05 |
| 729 | 5 | Looper Needle Guard (marked Q) for loopers Nos. 727, 10307 and 10307 A | 15 |
| | | " " " Screw No. 73 A | 05 |
| * 730 | 15 | Needle Bar (hardened and ground) sizes .257, .260, .263, .266, .270, .273, .276, .280 and .283, for No. 8 gauge machines | 1 50 |

*See Page No. 13

PRICE LIST OF PARTS

THESE PARTS ARE FURNISHED AT LIST PRICES FOR REPAIRS ONLY.
SEE NOTICE ON PAGE 3.

| Number to order by | Plate No. | Postage will be charged on all parts sent by mail. Figures in second column refer only to plates illustrating parts, and are not to be used in ordering. Prices subject to change without notice. | Price per part |
|--------------------------|-----------|---|----------------|
| TERMS ON PARTS, NET CASH | | | |
| * 730 A | 15 | Needle Bar (hardened and ground) sizes .257, .260, .263, .266, .270, .273, .276, 280 and .283, for No. 12 gauge machines..... | \$1 50 |
| | | “ “ Set Screws No. 88..... | 03 |
| 732 | 17 | Needle Clamp Collar, for No. 8 gauge machines..... | 50 |
| | | “ “ “ Screw No. 89..... | 03 |
| 732 A | 17 | “ “ “ for No. 12 gauge machines..... | 50 |
| 738 | 3 | Presser Foot, for No. 8 gauge Style 10300 C..... | 1 35 |
| 738 A | 3 | “ “ for No. 12 gauge Style 10300 C..... | 1 35 |
| | | “ “ Screw No. 91..... | 04 |
| 750 | — | Lace Edging Spool Support, complete, with thirteen-inch axle..... | 2 00 |
| 751 | 28 | “ “ “ “ Frame Pin (hardened, length over all three inches).... | 10 |
| | | “ “ “ “ Frame Pin Thumb Screw No. 201 C..... | 10 |
| 752 | 28 | “ “ “ “ Axle (length over all thirteen inches)..... | 35 |
| 753 | 17 | “ “ “ “ Cone, adjustable..... | 20 |
| | | “ “ “ “ Cone Screw No. 188 D..... | 10 |
| 907 | 10 | Knife Depresser Cam Stud Nut..... | 10 |
| 1000 | 22 | Thread Pad, complete..... | 1 00 |
| 1002 | 22 | “ “ Cup..... | 25 |
| | | “ “ Cup Screw No. 93..... | 04 |
| 1003 | 22 | “ “ Cup Pin..... | 10 |
| 1004 | 22 | “ “ Cup Felt..... | 05 |
| 1005 | 22 | “ “ Bracket..... | 15 |
| | | “ “ Bracket Screw No. 98..... | 03 |
| 1007 | 13 | “ “ Tension Plate, complete..... | 10 |
| 1008 | 13 | “ “ Tension Felt, lower..... | 03 |
| 1054 | 17 | Looper Eccentric (ground, marked V2, eccentricity .152 inch) for Style 6900 G..... | 50 |
| | | “ “ Screw No. 96..... | 03 |
| 1075 | 24 | Tension Bracket, for Style 6900 G..... | 35 |
| | | “ “ Screws No. 93..... | 04 |
| 1096 | 7 | Stop Screw, for guide on presser foot No. 6927 A..... | 03 |
| 1216 | 25 | Needle Lever Connection, complete, with separable bearings and oil reservoir..... | 3 00 |
| 1275 | 18 | Needle Lever Stud (hardened and ground) internal oiling, with screw, standard size.... | 1 50 |
| 1275 A | — | “ “ “ (hardened and ground) internal oiling, without screw, standard size. | 1 45 |

*See Page No. 13

PRICE LIST OF PARTS

[1275 B-1286 B]

THESE PARTS ARE FURNISHED AT LIST PRICES FOR REPAIRS ONLY.
SEE NOTICE ON PAGE 3.

| Number to order by | Plate No. | Postage will be charged on all parts sent by mail. Figures in second column refer only to plates illustrating parts, and are not to be used in ordering. Prices subject to change without notice. TERMS ON PARTS, NET CASH | Price per part |
|--------------------|-----------|---|----------------|
| 1275 B | — | Needle Lever Stud (hardened and ground) internal oiling, with screw, extra size on frame end (specify the number of thousandths of an inch larger than standard size) made only to order | \$1 75 |
| 1275 C | — | " " " (hardened and ground) internal oiling, with screw, extra size on lever end (specify the number of thousandths of an inch larger than standard size) made only to order | 1 75 |
| 1275 D | — | " " " (hardened and ground) internal oiling, with screw, extra size on both ends (specify the number of thousandths of an inch larger on each end than standard size) made only to order | 2 00 |
| 1275 E | — | " " " (hardened and ground) internal oiling, without screw, extra size on frame end (specify the number of thousandths of an inch larger than standard size) made only to order | 1 70 |
| 1275 F | — | " " " (hardened and ground) internal oiling, without screw, extra size on lever end (specify the number of thousandths of an inch larger than standard size) made only to order | 1 70 |
| 1275 G | — | " " " (hardened and ground) internal oiling, without screw, extra size on both ends (specify the number of thousandths of an inch larger on each end than standard size) made only to order | 1 95 |
| 1280 | 10 | " " " Screw No. 22586 | 05 |
| 1286 | 17 | Needle Lever Bolt Nut | 10 |
| | | Needle Bar Link Pin (hardened and ground) complete, internal oiling, also for Nos. 54 A, 486 and 15446 B | 30 |
| | | " " " " Screw, upper, No. 77 | 03 |
| | | " " " " Screw, lower, No. 78 | 03 |
| 1286 A | 17 | " " " " (hardened and ground) internal oiling, without spring, ball or screw | 20 |
| 1286 B | 13 | " " " " Spring | 04 |
| | | " " " " Spring Screw No. 22560 | 03 |

[1287-5142]

PRICE LIST OF PARTS

THESE PARTS ARE FURNISHED AT LIST PRICES FOR REPAIRS ONLY.
SEE NOTICE ON PAGE 3.

| Number to order by | Plate No. | Postage will be charged on all parts sent by mail. Figures in second column refer only to plates illustrating parts, and are not to be used in ordering. Prices subject to change without notice. | Price per part |
|--------------------------|-----------|---|----------------|
| TERMS ON PARTS, NET CASH | | | |
| 1287 | 13 | Needle Bar Thread Nipper, complete..... | \$0 50 |
| 1288 | 13 | " " " " Collar..... | 35 |
| | | " " " " Collar Screw No. 88..... | 03 |
| 1290 | 13 | " " " " Spring (.016-inch diameter wire)..... | 03 |
| 1346 | 11 | Tension Post (length over all $1\frac{11}{16}$ inches) for use with hardened steel ferrule No. 1347..... | 20 |
| 1347 | 11 | " Post Ferrule (length over all $\frac{5}{16}$ inch, hardened) for use with tension post No. 1346..... | 08 |
| 1349 | 13 | " Spring (.036-inch diameter wire) for needle threads..... | 04 |
| 1361 | 4 | Presser Spring Pin..... | 03 |
| 1362 | 4 | Main Shaft Sleeve Pin..... | 03 |
| 1588 | 4 | Spring Latch, for No. 12750..... | 05 |
| | | " " Screw No. 22562..... | 04 |
| 1755 | 17 | Presser Foot Lifter (hardened) for Style 6900 G..... | 30 |
| | | " " " Screw No. 86..... | 05 |
| 2538 | 17 | Thread Controller Rack and Presser Spring Rest Support Collar, also for No. 64..... | 30 |
| | | " " " and Presser Spring Rest Support Collar Screw No. 88..... | 03 |
| 3004 | 6 | Cast-off Wire, for use with take-up No. 3023..... | 30 |
| | | " " Screw No. 87..... | 04 |
| 3005 F | 2 | Main Feed Dog, for Styles 10300 F and 10300 G..... | 1 00 |
| | | " " " Screws No. 22593..... | 05 |
| 3005 G | — | Nos. 3005 F, 5150 and two No. 22593, assembled..... | 1 85 |
| 3005 L | — | Nos. 3005 M, 15447 C and two No. 22593, assembled... | 2 10 |
| 3005 M | 2 | Feed Dog, for Nos. 8 and 12 gauge tilting feed machines in Class 10300..... | 1 10 |
| | | " " Screws No. 22593..... | 05 |
| 3023 | 18 | Take-up, for use with cast-off wire No. 3004..... | 1 00 |
| | | " Screw No. 89..... | 03 |
| 3026 C | 2 | Differential Feed Dog, for Styles 10300 F and 10300 G.. | 1 25 |
| | | " " " Screw No. 22585..... | 04 |
| 3072 | 6 | Cast-off Wire Guard..... | 25 |
| | | " " " Screw No. 90..... | 04 |
| 3336 | 13 | Knife Depresser Spring, for Style 6900 G..... | 05 |
| 5125 | 3 | Feed Bar Needle Guard (hardened, marked AJ) for Styles 6900 H, 10300 B, 10300 C and 10300 D..... | 55 |
| | | " " " " Screw No. 94..... | 04 |
| 5142 | 24 | Feed Bar, for Styles 6900 H, 10300 B, 10300 C and 10300 D..... | 75 |
| | | " " Screws No. 88..... | 03 |

PRICE LIST OF PARTS

[5143-6905 H]

THESE PARTS ARE FURNISHED AT LIST PRICES FOR REPAIRS ONLY.
SEE NOTICE ON PAGE 3.

| Number to order by | Plate No. | Postage will be charged on all parts sent by mail. Figures in second column refer only to plates illustrating parts, and are not to be used in ordering. Prices subject to change without notice. TERMS ON PARTS, NET CASH | Price per part |
|--------------------|-----------|---|----------------|
| 5143 | 24 | Feed Bar, for differential feed dog..... | \$0 90 |
| 5144 | 10 | Differential Feed Bar Link Stud..... | 10 |
| 5150 | 2 | Main Feed Dog Holder, for Styles 10300 F and 10300G | 75 |
| | | “ “ “ “ Screw No. 93..... | 04 |
| 5156 | 26 | Feed Rocker, for differential feed machines..... | 1 25 |
| | | “ “ Screws No. 88..... | 03 |
| 5157 | 26 | Feed Rocker Connection..... | 65 |
| | | “ “ Connection Screws No. 135..... | 06 |
| * 5217 | 15 | Needle Bar (hardened and ground) sizes .257, .260, .263, .266, .270, .273, .276, .280, and .283, for Style 12700 A..... | 1 50 |
| | | “ “ Set Screws No. 88..... | 03 |
| 5231 | 17 | Needle Separator, for right-hand set of needles on Style 12700 A..... | 30 |
| 5232 | — | “ “ Pin..... | 03 |
| 6035 | 27 | Frame Guard..... | 1 00 |
| | | “ “ Screws No. 93..... | 04 |
| 6035 A | 27 | Cloth Plate Guard, including felt cushion, for machines in Classes 6900 and 12700..... | 1 00 |
| | | “ “ “ Screws No. 22730..... | 05 |
| 6035 B | — | Felt Cushion, for No. 6035 A..... | 03 |
| | | “ “ Screw No. 187 A..... | 04 |
| 6036 | 16 | Looper Connection Rod, tubular (length over all $8\frac{7}{8}$ inches) for use with Nos. 36 L and 36 R..... | 50 |
| 6037 | 16 | “ “ “ tubular (length over all $8\frac{7}{8}$ inches) for use with Nos. 6038 and 6039..... | 30 |
| 6038 | 18 | “ “ “ Ball Joint, left, complete, for use with Nos. 6037 and 6934..... | 1 25 |
| 6039 | 18 | “ “ “ Ball Joint, right, complete, for use with Nos. 6037 and 6934..... | 1 25 |
| | | “ “ “ Ball Joint Screws No. 97 A..... | 04 |
| 6042 | 11 | Needle Lever Bolt (length over all $1\frac{1}{2}$ inches)..... | 20 |
| 6901 | 27 | Cloth Plate, for Style 6900 G..... | 3 00 |
| | | “ “ Screws No. 80..... | 05 |
| | | “ “ Screw, fillister head, No. 93 A..... | 04 |
| 6904 | 6 | Cast-off Wire, for Style 6900 G..... | 30 |
| | | “ “ Screw No. 87..... | 04 |
| 6905 A | 2 | Feed Dog, for Style 6900 G: | |
| 6905 A-12 | — | “ “ for Nos. 8 and 12 gauges..... | 1 25 |
| 6905 H | 2 | “ “ for Style 6900 H, also for side buckle strap machines in Class 6900: | |
| 6905 H-12 | — | “ “ for No. 12 gauge..... | 95 |

*See Page No. 13

PRICE LIST OF PARTS

THESE PARTS ARE FURNISHED AT LIST PRICES FOR REPAIRS ONLY.
SEE NOTICE ON PAGE 3.

| Number to order by | Plate No. | Postage will be charged on all parts sent by mail. Figures in second column refer only to plates illustrating parts, and are not to be used in ordering. Prices subject to change without notice. TERMS ON PARTS, NET CASH | Price per part |
|--------------------|-----------|---|----------------|
| 6905-H | | Continued: | |
| 6905 H-16 | — | Feed Dog, for No. 16 gauge..... | \$ 1 25 |
| | | “ “ Screw No. 93..... | 04 |
| 6906 | 17 | Feed Lift and Knife Bar Eccentric (ground, marked CD) for Style 6900 G..... | 1 50 |
| | | “ “ and Knife Bar Eccentric Screw No. 96..... | 03 |
| 6907 H | 5 | Looper, with guard, for Style 6900 H, also for side buckle strap machines in Class 6900..... | 1 45 |
| 6908 A | 5 | “ without guard, for Style 6900 H, also for side buckle strap machines in Class 6900..... | 1 25 |
| 6908 G | 5 | “ for Nos. 8 and 12 gauge Style 6900 G..... | 1 25 |
| | | “ Set Screw No. 73..... | 05 |
| 6915 G | 27 | Needle Lever (steel forging) for Style 6900 G..... | 2 35 |
| 6920 A | 3 | Presser Foot, with yielding sides, for Style 6900 H: | |
| 6920 A-12 | — | “ “ for No. 12 gauge..... | 4 00 |
| 6920 A-16 | — | “ “ for No. 16 gauge..... | 4 00 |
| 6920 B | 3 | “ “ for Style 6900 G: | |
| 6920 B-8 | — | “ “ for No. 8 gauge..... | 1 60 |
| 6920 B-12 | — | “ “ for No. 12 gauge..... | 1 60 |
| 6920 C | 3 | “ “ for side buckle straps, $\frac{1}{16}$ inch wide: | |
| 6920 C-12 | — | “ “ for No. 12 gauge..... | 2 25 |
| 6920 C-16 | — | “ “ for No. 16 gauge..... | 2 25 |
| 6920 E | 3 | “ “ for Style 6900 E: | |
| 6920 E-12 | — | “ “ for No. 12 gauge..... | 1 25 |
| | | “ “ Screw No. 91..... | 04 |
| 6923 G | 18 | Take-up, for Style 6900 G..... | 1 00 |
| | | “ Screw No. 89..... | 03 |
| 6924 A | 1 | Throat Plate, for Style 6900 G: | |
| 6924 A-8 | — | “ “ for No. 8 gauge..... | 2 50 |
| 6924 A-12 | — | “ “ for No. 12 gauge..... | 2 50 |
| 6924 E | 1 | “ “ for Style 6900 E: | |
| 6924 E-12 | — | “ “ for No. 12 gauge..... | 1 25 |
| 6924 H | 1 | “ “ for Style 6900 H, also for side buckle strap machines in Class 6900: | |
| 6924 H-12 | — | “ “ for No. 12 gauge..... | 1 25 |
| 6924 H-16 | — | “ “ for No. 16 gauge..... | 1 50 |
| | | “ “ Screws No. 87..... | 04 |
| 6927 A | 3 | Presser Foot, with spring guide, for Style 6900 G: | |
| 6927 A-12 | — | “ “ for No. 12 gauge..... | 3 00 |
| | | “ “ Screw No. 91..... | 04 |
| 6932 | 25 | Looper Rocker Frame (hardened) for Style 6900 G..... | 1 20 |
| | | “ “ “ Screw, left, No. 77..... | 03 |
| | | “ “ “ Screw, right, No. 98..... | 03 |
| | | “ “ “ Spot Screw No. 96..... | 03 |

PRICE LIST OF PARTS

[6933-6967 F]

THESE PARTS ARE FURNISHED AT LIST PRICES FOR REPAIRS ONLY.
SEE NOTICE ON PAGE 3.

| Number to order by | Plate No. | Postage will be charged on all parts sent by mail. Figures in second column refer only to plates illustrating parts, and are not to be used in ordering. Prices subject to change without notice. | Price per part |
|--------------------------|-----------|---|----------------|
| TERMS ON PARTS, NET CASH | | | |
| 6933 | 16 | Looper Connection Rod, tubular (length over all 9 ³ / ₈ inches) for use with Nos. 36 L and 36 R..... | \$0 50 |
| 6934 | 16 | " " " tubular (length over all 9 ³ / ₈ inches) for use with Nos. 6038 and 6039..... | |
| 6937 | 21 | Differential Rocker, for Style 6900 G..... | 1 00 |
| | | " " Screw No. 89..... | 03 |
| 6938 | 21 | Differential Rocker Support..... | 1 50 |
| | | " " Support Screws No. 136..... | 08 |
| 6939 | 11 | Needle Lever Bolt (length over all 1 ⁷ / ₁₆ inches)..... | 20 |
| 6948 A | 21 | Knife Depresser Lever, for Style 6900 G..... | 30 |
| | | " " " Screws No. 22585..... | 04 |
| 6948 B | 21 | Knife Depresser | 1 20 |
| | | " " Stud No. 420..... | 20 |
| 6948 C | 21 | " " Bracket..... | 70 |
| | | " " Bracket Screws No. 22517..... | 05 |
| 6948 D | 9 | " " Cam Stud (hardened)..... | 10 |
| 6954 A | 4 | Stationary Knife | 25 |
| 6954 B | 4 | " " Clamp..... | 30 |
| | | " " Clamp Screw No. 22561..... | 04 |
| 6955 A | 4 | Penetrating Knife | 80 |
| | | " " Clamp Screw No. 87 U..... | 04 |
| | | " " Stop and Adjusting Screw No. 87 U.. | 04 |
| 6956 A | 21 | Knife Bar | 1 20 |
| | | " " Adjusting Screw No. 75..... | 04 |
| 6956 B | 12 | " " Depresser Cam..... | 35 |
| | | " " Depresser Cam Screw No. 87 U..... | 04 |
| 6956 C | 13 | " " Spring..... | 04 |
| 6956 D | 10 | " " Adjusting Screw Check Nut..... | 15 |
| 6956 E | 13 | " " Adjusting Screw Check Nut Retainer..... | 05 |
| | | " " Adjusting Screw Check Nut Retainer Screw No. 605..... | 05 |
| 6967 | 21 | " " Carrier, with shoes, for machines using knife bar carrier guide..... | 2 55 |
| | | " " " Clamp Screw No. 85..... | 05 |
| 6967 B | 21 | " " " Guide..... | 40 |
| | | " " " Guide Screw No. 93..... | 04 |
| 6967 C | 12 | " " " Guide Bearing (hardened)..... | 18 |
| 6967 D | 21 | " " " with shoes, for machines using supporting screw No. 141..... | 2 55 |
| 6967 F | 10 | " " " Supporting Screw Bushing..... | 10 |

[6968-7638]

PRICE LIST OF PARTS

THESE PARTS ARE FURNISHED AT LIST PRICES FOR REPAIRS ONLY.
SEE NOTICE ON PAGE 3.

| Number to order by | Plate No. | Postage will be charged on all parts sent by mail. Figures in second column refer only to plates illustrating parts, and are not to be used in ordering. Prices subject to change without notice. | | Price per part |
|-----------------------|-----------|--|----|----------------------|
| | | TERMS ON PARTS, NET CASH | | |
| 6968 | 21 | Knife Bar Carrier Fork, with shoes..... | | \$1 50 |
| | | “ “ “ Fork Clamp Screw, lower, No. 22522 | | 06 |
| | | “ “ “ Fork Clamp Screws, upper, No. 90.. | | 04 |
| 6970 | 14 | Needle Lever Thread Eyelet, for Style 6900 G..... | | 40 |
| | | “ “ “ Screws No. 98 A..... | | 04 |
| 6975 A | 14 | Intermediate Pull-off, for needle and looper threads on Style 6900 G..... | | 1 25 |
| 6976 | 14 | “ “ Thread Wire, for looper threads... | | 12 |
| | | “ “ Thread Wire Screw No. 97..... | | 04 |
| 6985 | 24 | Feed Bar, for Style 6900 G..... | | 75 |
| | | “ “ Screws No. 88..... | | 03 |
| 6990 | 3 | Spring, for guide on presser foot No. 6927 A..... | | 06 |
| 6998 G | 29 | Knife Grinder, complete, including emery wheel..... | 10 | 00 |
| 6998 H | 26 | Grinder Head..... | 2 | 00 |
| 6998 J | 26 | Grinder Swinging Frame..... | 2 | 50 |
| | | “ “ “ Set Screw No. 22591..... | | 06 |
| 6998 K | 15 | “ “ “ Pivot Pin (hardened and ground)..... | 1 | 90 |
| 6998 M | 12 | “ “ “ Stop Collar..... | | 90 |
| | | “ “ “ Stop Collar Set Screw No. 22560 B..... | | 04 |
| | | “ “ “ Stop Collar Stop Screw No. 75 | | 04 |
| 6998 N | 12 | Stationary Knife Clamping Plate, for knife grinder..... | 80 | |
| | | “ “ Clamping Plate Thumb Screw No. G26 | 15 | |
| | | “ “ Clamping Plate Screws No. 22524..... | 05 | |
| 6998 P | 12 | “ “ Stop, for knife grinder..... | 60 | |
| | | “ “ Stop Screw No. 134..... | 10 | |
| 6998 Q | 12 | Penetrating Knife Swinging Frame Clamp, for knife grinder..... | 60 | |
| | | “ “ “ Frame Clamp Thumb Screw No. G10..... | 15 | |
| 6998 R | 12 | Knife Clamp, for bevel cut on penetrating knife, for knife grinder..... | 60 | |
| | | “ “ Thumb Screw No. G26..... | 15 | |
| 6998 S | 26 | Knife Holder, for bevel cut on penetrating knife, for knife grinder..... | 2 | 00 |
| | | “ “ Screw No. 9675..... | 15 | |
| 6998 T | 26 | Grinder Emery Wheel..... | 60 | |
| 7453 | 14 | Tension Thread Eyelet, lower, for intermediate pull-off on Style 6900 G..... | 10 | |
| | | “ “ “ Screw No. 98..... | 03 | |
| 7638 | 14 | Lower Thread Deflecting Wire..... | 10 | |
| | | “ “ “ Wire Screw No. 94..... | 04 | |

PRICE LIST OF PARTS

[8645-10308 A]

THESE PARTS ARE FURNISHED AT LIST PRICES FOR REPAIRS ONLY.

SE NOTICE ON PAGE 3.

| Number to order by | Plate No. | Postage will be charged on all parts sent by mail. Figures in second column refer only to plates illustrating parts, and are not to be used in ordering. Prices subject to change without notice. | Price per part |
|--------------------------|-----------|---|----------------|
| TERMS ON PARTS, NET CASH | | | |
| 8645 | 26 | Quilting Guide, right..... | \$0 30 |
| 8646 | 26 | “ “ left..... | 30 |
| | | “ “ Screw No. 22558..... | 04 |
| 8647 | 26 | “ “ Support..... | 80 |
| | | “ “ Support Screw No. 22558..... | 04 |
| 8648 | | “ “ complete..... | 1 50 |
| 8651 | 14 | Needle Thread Take-up Wire..... | 07 |
| | | “ “ “ Wire Screw No. 87 U..... | 04 |
| 9034 | 14 | Needle Bar Thread Eyelet, with three eyes..... | 10 |
| | | “ “ “ “ Screw No. 87 U..... | 04 |
| 9675 | 9 | Knife Holder Screw, for knife grinder..... | 15 |
| 10301 | 27 | Cloth Plate, for Styles 10300 B and 10300 F..... | 2 50 |
| | | “ “ Screws No. 80..... | 05 |
| | | “ “ Screw, fillister head, No. 93 A..... | 04 |
| 10301 C | 27 | “ “ for Styles 10300 C, 10300 D and 10300 G.. | 1 75 |
| | | “ “ Screws No. 80..... | 05 |
| 10301 F | 27 | “ “ for use without feed crank cover, on tilting feed machines..... | 2 60 |
| | | “ “ Screws No. 80..... | 05 |
| | | “ “ Screw, fillister head, No. 93 A..... | 04 |
| 10301 G | 27 | “ “ for use with feed crank cover, on tilting feed machines..... | 1 85 |
| | | “ “ Screws No. 80..... | 05 |
| 10303 A | 19 | Cloth Plate Edge Guide..... | 35 |
| 10303 B | 19 | “ “ “ “ for Styles 10300 B and 10300 F, also for tilting feed machines without feed crank cover.... | 35 |
| 10303 C | 19 | “ “ “ “ for Style 10300 C..... | 30 |
| 10303 D | 19 | “ “ “ “ for Styles 10300 D and 10300 G | 35 |
| 10303 G | 19 | “ “ “ “ for tilting feed machines with feed crank cover..... | 35 |
| | | “ “ “ “ Screws No. 25 C..... | 05 |
| 10305 | 2 | Feed Dog, for Nos. 8 and 12 gauge Style 10300 C..... | 85 |
| | | “ “ Screw No. 93..... | 04 |
| 10307 | 5 | Looper, with guard, for machines in Class 10300..... | 1 45 |
| 10307 A | 5 | “ with guard, for use with throat plates Nos. 10324 A and 10324 B..... | 1 45 |
| 10308 | 5 | “ without guard, for machines in Class 10300..... | 1 25 |
| 10308 A | 5 | “ without guard, for use with throat plates Nos. 10324 A and 10324 B..... | 1 25 |
| | | “ Set Screw No. 73..... | 05 |

[10314-10336]

PRICE LIST OF PARTS

THESE PARTS ARE FURNISHED AT LIST PRICES FOR REPAIRS ONLY.
SEE NOTICE ON PAGE 3.

| Number to order by | Plate No. | Postage will be charged on all parts sent by mail. Figures in second column refer only to plates illustrating parts, and are not to be used in ordering. Prices subject to change without notice. | Price per part |
|--------------------------|-----------|---|----------------|
| TERMS ON PARTS, NET CASH | | | |
| 10314 | 17 | Looper Eccentric (ground, marked C, eccentricity .135 inch) for machines in Class 10300... | \$0 50 |
| | | “ “ Screw No. 96..... | 03 |
| 10315 | 27 | Needle Lever (steel forging) for machines in Class 10300 | 2 25 |
| 10320 B | 4 | Presser Foot, for Styles 10300 B and 10300 D: | |
| 10320 B-8 | — | “ “ for No. 8 gauge..... | 2 25 |
| 10320 B-12 | — | “ “ for No. 12 gauge..... | 2 25 |
| 10320 F | 4 | “ “ for Styles 10300 F and 10300 G, also for tilting feed machines: | |
| 10320 F-8 | — | “ “ for No. 8 gauge..... | 3 00 |
| 10320 F-12 | — | “ “ for No. 12 gauge..... | 3 00 |
| | | “ “ Screw No. 91..... | 04 |
| 10322 | 23 | Main Shaft (hardened and ground) sizes .530, .531, .533, .536, .539 and .542, for machines in Class 10300... | 2 50 |
| 10324 | 1 | Throat Plate, for Styles 10300 B, 10300 C and 10300 D: | |
| 10324-8 | — | “ “ for No. 8 gauge..... | 1 25 |
| 10324-12 | — | “ “ for No. 12 gauge..... | 1 25 |
| 10324 A | 1 | “ “ for deflected stitch on Styles 10300 B, 10300 C and 10300 D: | |
| 10324 A-8 | — | “ “ for No. 8 gauge..... | 1 35 |
| 10324 B | 1 | “ “ for deflected stitch on Styles 10300 F and 10300 G, also for machines with tilting feed: | |
| 10324 B-8 | — | “ “ for No. 8 gauge..... | 1 60 |
| 10324 B-12 | — | “ “ for No. 12 gauge..... | 1 60 |
| 10324 F | 1 | “ “ for Styles 10300 F and 10300 G, also for machines with tilting feed: | |
| 10324 F-8 | — | “ “ for No. 8 gauge..... | 1 50 |
| 10324 F-12 | — | “ “ for No. 12 gauge..... | 1 50 |
| | | “ “ Screws No. 87..... | 04 |
| 10333 | 27 | Cloth Plate Guard, sheet metal, for Styles 10300 B and 10300 F..... | 30 |
| | | “ “ “ Screws No. 22582 B..... | 05 |
| 10333 C | 27 | “ “ “ sheet metal, for Styles 10300 C, 10300 D and 10300 G..... | 40 |
| | | “ “ “ Screw, front, No. 92..... | 04 |
| | | “ “ “ Screw, back, No. 92 A..... | 04 |
| 10334 A | 14 | Needle Bar Thread Eyelet, with two eyes..... | 08 |
| | | “ “ “ “ Screw No. 87 U..... | 04 |
| 10335 | 14 | Lower Tension Arm Thread Guide, for machines in Classes 6900 and 10300..... | 10 |
| 10336 | 14 | Needle Thread Pull-off Wire..... | 05 |
| | | “ “ “ “ Screw No. 87 U..... | 04 |

PRICE LIST OF PARTS

[10337-10359]

THESE PARTS ARE FURNISHED AT LIST PRICES FOR REPAIRS ONLY.
SEE NOTICE ON PAGE 3.

| Number to order by | Plate No. | Postage will be charged on all parts sent by mail. Figures in second column refer only to plates illustrating parts, and are not to be used in ordering. Prices subject to change without notice. TERMS ON PARTS, NET CASH | Price per part |
|--------------------|-----------|---|----------------|
| 10337 | 27 | Feed Crank Cover Bracket, for Styles 10300 C, 10300 D and 10300 G..... | \$0 50 |
| | | “ “ “ “ Screws No. 80..... | 05 |
| 10338 | 14 | Pull-off Wire Post and Edging Guide Support..... | 45 |
| | | “ “ “ and Edging Guide Support Screw No. 22529..... | 05 |
| 10339 | 21 | Lace Edging Guide, for machines in Class 10300..... | 60 |
| | | “ “ “ Screw No. 87 U..... | 04 |
| 10340 | 5 | Spreader, for machines in Class 10300: | |
| 10340-8 | — | “ for No. 8 gauge..... | 80 |
| 10340-12 | — | “ for No. 12 gauge..... | 80 |
| | | “ Screw No. 73..... | 05 |
| 10341 | 16 | Spreader Bar (hardened and ground) sizes .257, .260 and .263..... | 1 00 |
| 10342 | 13 | Spreader Bar Spring..... | 05 |
| 10343 | 18 | “ “ Lifter..... | 1 00 |
| | | “ “ Lifter Screw No. 88..... | 03 |
| 10344 | 18 | “ “ Rocker (hardened)..... | 75 |
| | | “ “ Rocker Clamp Screw No. 97..... | 04 |
| 10345 | 16 | “ “ Rocker Connection Rod (4 $\frac{1}{4}$ inches long)..... | 20 |
| 10346 | 18 | “ “ Rocker, complete with ball joint..... | 1 65 |
| | | “ “ Rocker Screws No. 97 A..... | 04 |
| †10347 | 18 | “ “ Rocker Connection Rod Ball Joint, right, complete, also for No. 10356..... | 1 25 |
| | | “ “ Rocker Connection Rod Ball Joint Screws No. 97 A..... | 04 |
| 10348 | 26 | “ “ Bell Crank Lever..... | 1 00 |
| 10349 | 9 | “ “ Bell Crank Lever Ball (hardened) also for Nos. 10347, 10357 and 10359..... | 35 |
| 10350 | 12 | “ “ Bell Crank Lever Washer, also for No. 10359..... | 05 |
| 10352 | 26 | “ “ Cross Head..... | 1 50 |
| 10353 | 26 | “ “ Cross Head Frame..... | 1 00 |
| | | “ “ Cross Head Frame Screws No. 136..... | 08 |
| 10354 | 26 | “ “ Cross Head Gib, upper..... | 50 |
| 10355 | 26 | “ “ Cross Head Gib, lower..... | 45 |
| | | “ “ Cross Head Gib Screws No. 22516..... | 04 |
| 10356 | 16 | “ “ Cross Head Connection Rod (3 $\frac{3}{16}$ inches long)..... | 25 |
| †10357 | 18 | “ “ Cross Head Connection Rod Ball Joint, left, complete..... | 1 25 |
| | | “ “ Cross Head Connection Rod Ball Joint Screws No. 97 A..... | 04 |
| 10359 | 26 | “ “ Cross Head Bell Crank Lever..... | 1 00 |

† See Page No 13

[10360-12718]

PRICE LIST OF PARTS

THESE PARTS ARE FURNISHED AT LIST PRICES FOR REPAIRS ONLY
SEE NOTICE ON PAGE 3.

| Number to order by | Plate No. | Postage will be charged on all parts sent by mail. Figures in second column refer only to plates illustrating parts, and are not to be used in ordering. Prices subject to change without notice. | Price per part |
|--------------------------|-----------|---|----------------|
| TERMS ON PARTS, NET CASH | | | |
| 10360 | 26 | Bell Crank Lever Frame | \$1 75 |
| | | " " " " Screws No. 135..... | 06 |
| 10363 | 17 | Spreader Eccentric (marked AK)..... | 2 00 |
| | | " " Spot Screw No. 81..... | 03 |
| | | " " Set Screw No. 95..... | 03 |
| ‡ 10364 | 25 | " " Connection..... | 1 35 |
| | | " " Connection Screws, upper, No. 97 A | 04 |
| | | " " Connection Screws, lower, No. 75 A | 04 |
| 11261 A | 11 | Tension Post (length over all $1\frac{7}{8}$ inches) for use with hardened steel ferrule No. 11261 B | 25 |
| 11261 B | 11 | " " Ferrule (hardened, length over all $\frac{31}{64}$ inch) for use with tension post No. 11261 A... | 10 |
| 11262 | 14 | Tension Thread Eyelet, lower, with two eyes (distance between centers of eyes $1\frac{9}{16}$ inches) for machines in Class 12700..... | 10 |
| | | Tension Thread Eyelet Screw No. 98 | 03 |
| 12701 | 27 | Cloth Plate, for Style 12700 A..... | 2 50 |
| | | " " Screws No. 80 | 05 |
| | | " " Screw, fillister head, No. 93 A..... | 04 |
| 12704 | 6 | Cast-off Wire, for Style 12700 A..... | 35 |
| | | " " Screw No. 87..... | 04 |
| 12705 | 2 | Feed Dog, for Style 12700 A: | |
| 12705-24-12 | — | " " for No. 24-12 gauge..... | 1 75 |
| 12705-30-12 | — | " " for No. 30-12 gauge..... | 1 75 |
| 12705-32-12 | — | " " for No. 32-12 gauge..... | 1 75 |
| 12705-36-12 | — | " " for No. 36-12 gauge..... | 1 75 |
| | | " " Screw No. 93..... | 04 |
| 12708 | — | Looper, front, for Style 12700 A: | |
| 12708-24-12 | 6 | " for No. 24-12 gauge..... | 1 25 |
| 12708-30-12 | 6 | " for No. 30-12 gauge..... | 1 25 |
| 12708-32-12 | 6 | " for No. 32-12 gauge..... | 1 25 |
| 12708-36-12 | 6 | " for No. 36-12 gauge..... | 1 25 |
| 12709 A | — | " back, for Style 12700 A: | |
| 12709 A-36-12 | 6 | " for Nos. 24-12, 30-12, 32-12 and 36-12 gauges | 1 25 |
| | | " Set Screw No. 73 | 05 |
| 12718 | 17 | Needle Holder, for Style 12700 A: | |
| 12718-24-12 | — | " " for No. 24-12 gauge..... | 1 75 |
| 12718-30-12 | — | " " for No. 30-12 gauge..... | 1 75 |
| 12718-32-12 | — | " " for No. 32-12 gauge..... | 1 75 |
| 12718-36-12 | — | " " for No. 36-12 gauge..... | 1 75 |
| | | " " Screw No. 89 | 03 |

‡ See Page No. 13

PRICE LIST OF PARTS

[12720A-15430H]

THESE PARTS ARE FURNISHED AT LIST PRICES FOR REPAIRS ONLY.
SEE NOTICE ON PAGE 3.

| Number to order by | Plate No | Description | Price per part |
|---|----------|---|----------------|
| Postage will be charged on all parts sent by mail. Figures in second column refer only to plates illustrating parts, and are not to be used in ordering. Prices subject to change without notice. | | | |
| TERMS ON PARTS, NET CASH | | | |
| 12720 A | 4 | Presser Foot, for Style 12700 A: | |
| 12720 A-24-12 | — | “ “ for No. 24-12 gauge..... | \$4 50 |
| 12720 A-30-12 | — | “ “ for No. 30-12 gauge..... | 4 50 |
| 12720 A-32-12 | — | “ “ for No. 32-12 gauge..... | 4 50 |
| 12720 A-36-12 | — | “ “ for No. 36-12 gauge..... | 4 50 |
| | | “ “ Screw No. 91..... | 04 |
| 12723 | 18 | Take-up, for Style 12700 A..... | 75 |
| | | “ Screw No. 89..... | 03 |
| 12724 | 1 | Throat Plate, for Style 12700 A: | |
| 12724-24-12 | — | “ “ for No. 24-12 gauge..... | 2 00 |
| 12724-30-12 | — | “ “ for No. 30-12 gauge..... | 2 00 |
| 12724-32-12 | — | “ “ for No. 32-12 gauge..... | 2 00 |
| 12724-36-12 | — | “ “ for No. 36-12 gauge..... | 2 00 |
| | | “ “ Screws No. 87..... | 04 |
| 12730 | 17 | Needle Stop Collar, for Nos. 32-12 and 36-12 gauges... | 90 |
| 12730 A | 17 | “ “ “ for Nos. 24-12 and 30-12 gauges... | 90 |
| | | “ “ “ Screw No. 88..... | 03 |
| 12735 | — | Take up Thread Eyelet, for Style 12700 A: | |
| 12735-36-12 | 14 | “ “ “ for Nos. 24-12, 30-12, 32-12 and 36-12 gauges..... | 60 |
| | | “ “ “ Support Screw No. 97..... | 04 |
| 12741 | 21 | Lace Edging Guide..... | 70 |
| | | “ “ “ Screw No. 87 U..... | 04 |
| 12750 | 21 | Straight Bar Lace Edging Controlling Guide, complete.. | 6 00 |
| 12873 | 13 | Bushing (ground) for needle bar bearings..... | 25 |
| | | “ Clamp Screw No. 22569..... | 05 |
| 12934 B | 9 | Feed Dog Pivot Screw, for tilting feed machines..... | 20 |
| 12935 | 16 | “ “ Tilting Rod, for tilting feed machines..... | 65 |
| 12964 C | 13 | Needle Bar Link Pin Spring Ball..... | 02 |
| 14544 | 16 | Differential Feed Bar Shaft (hardened and ground, 3 ⁹ / ₁₆ inches long)..... | 40 |
| 14675 | 12 | Knife Bar Carrier Shoe (hardened and ground) also for No. 6968..... | 10 |
| | | “ “ “ “ Screw No. 22570..... | 05 |
| ‡ 15430 | 25 | Needle Lever Connection Bearing, lower..... | 75 |
| | | “ “ “ Bearing Screws No. 22587.... | 05 |
| 15430 C | 10 | “ “ “ Tube Nut, upper, left thread | 10 |
| 15430 D | 10 | “ “ “ Tube Nut, lower, right thread | 10 |
| ‡ 15430 E | 25 | “ “ “ Bearing, upper..... | 70 |
| | | “ “ “ Bearing Screws No. 22587.... | 05 |
| ‡ 15430 F | 25 | “ “ “ Tube, with oil reservoir..... | 1 10 |
| 15430 H | 10 | “ “ “ Oil Reservoir Cover..... | 25 |

‡ See Page No. 13

PRICE LIST OF PARTS

THESE PARTS ARE FURNISHED AT LIST PRICES FOR REPAIRS ONLY.
SEE NOTICE ON PAGE 3.

| Number to order by | Plate No. | Postage will be charged on all parts sent by mail. Figures in second column refer only to plates illustrating parts, and are not to be used in ordering. Prices subject to change without notice. TERMS ON PARTS, NET CASH | Price per part |
|--------------------|-----------|---|----------------|
| 15430 K | 10 | Needle Lever Connection Oil Reservoir Leather Washer | \$0 02 |
| 15430 L | 25 | " " " Tube Felt..... | 02 |
| 15435 C | 14 | Pull-off Frame, adjustable, for needle threads on Style 6900 G..... | 50 |
| | | " " Screw No. 22529..... | 05 |
| 15446 | 24 | Feed Dog Tilting Bar, for tilting feed machines..... | 85 |
| | | " " " " Screws No. 88..... | 03 |
| 15446 B | 24 | Differential Feed Bar Link..... | 40 |
| | | " " " " Screw No. 97..... | 04 |
| 15446 C | 4 | " " " " Stud (hardened and ground) | 35 |
| 15447 | 24 | Feed Dog Supporting Bar, for tilting feed machines..... | 90 |
| 15447 A | 9 | " " Vertical Adjusting Screw, for tilting feed machines..... | 15 |
| 15447 B | 4 | Feed Dog Vertical Adjusting Screw Plate, for tilting feed machines..... | 25 |
| | | " " Vertical Adjusting Screw Plate Screws No. 87 | 04 |
| 15447 C | 2 | " " Holder, for tilting feed machines..... | 90 |
| 15447 E | 24 | Feed Bar, for main feed dog on Styles 10300 F and 10300 G..... | 1 10 |
| | | " " Screws No. 88..... | 03 |
| 15447 F | 24 | " " Shoe (hardened and ground)..... | 20 |
| | | " " Shoe Screw No. 93..... | 04 |
| 15447 G | 20 | " " Prong and Sponge..... | 35 |
| | | " " Prong Screws No. 94..... | 04 |
| 15447 H | 20 | Differential Feed Bar Guide..... | 45 |
| | | " " " " Screw, front, No. 93..... | 04 |
| | | " " " " Screw, back, No. 94..... | 04 |
| 15480 C | 4 | Spring, for presser foot No. 10320 F..... | 15 |
| | | " Screw No. 57 WD..... | 05 |
| 15492 | 11 | Tension Post, solid, for looper thread on Style 6900 G... | 25 |
| 16198 | 4 | Frame Thread Eyelet Holder, adjustable, for Style 6900 G | 35 |
| | | " " " " Screw No. 93..... | 04 |
| 21102 | 23 | Thread Guide, for Style D thread stand..... | 08 |
| | | " " Screw No. 22560..... | 03 |
| 21102 A | — | " " Holder, for Style D thread stand: | |
| 21102 A-2 | 23 | " " Holder, for two thread guides..... | 30 |
| 21102 A-4 | 23 | " " Holder, for three or four thread guides... | 40 |
| | | " " Holder Screw No. 22580..... | 03 |
| 21102 B | 28 | " " Holder Supporting Rod, for Style D thread stand..... | 12 |
| | | " " Holder Supporting Rod Screw No. 22560 | 03 |
| 21102 C | 28 | Spool Support Tube, for Style D thread stand..... | 70 |
| | | " " " Screws No. 96..... | 03 |

PRICE LIST OF PARTS

[21102 D-21211]

THESE PARTS ARE FURNISHED AT LIST PRICES FOR REPAIRS ONLY.
SEE NOTICE ON PAGE 3.

| Number to order by | Plate No. | Postage will be charged on all parts sent by mail. Figures in second column refer only to plates illustrating parts, and are not to be used in ordering. Prices subject to change without notice. TERMS ON PARTS, NET CASH | Price per part |
|--------------------|-----------|---|----------------|
| 21102 D | 28 | Base, for thread stands..... | \$0 40 |
| | | “ Screws No. 96..... | 03 |
| 21102 E | — | Spool Support, for Style D thread stand: | |
| 21102 E-2 | 28 | “ “ for two spools..... | 40 |
| 21102 E-3 | 28 | “ “ for three spools..... | 50 |
| | | “ “ Screw No. 96..... | 03 |
| 21106 B | 22 | Gravity Tension Thread Flyer and Spool Cap, assembled | 25 |
| 21113 | 23 | Thread Wire, complete (twenty-two inches long) for Style C thread stand..... | 35 |
| | | “ “ Screw No. 95..... | 03 |
| 21113 A | — | “ “ Extension (six inches long) for Style C thread stand..... | 05 |
| | | “ “ Extension Screw No. 95..... | 03 |
| 21113 B | — | Thread Wire Coupling, for Style C thread stand..... | 15 |
| | | “ “ Coupling Screws No. 22558..... | 04 |
| 21126 | 28 | Supporting Rod (19 $\frac{3}{4}$ inches long) for Style C thread stand..... | 20 |
| 21127 | 28 | “ “ Coupling, for Style C thread stand..... | 20 |
| | | “ “ Coupling Screws No. 22580..... | 03 |
| 21130 A | — | Spool Support, for Style C thread stand: | |
| 21130 A-3 | 28 | “ “ for three spools..... | 70 |
| 21130 A-5 | 28 | “ “ for five spools..... | 90 |
| | | “ “ Screw No. 22622..... | 03 |
| 21145 | 23 | Wooden Cone, for thread stands..... | 10 |
| 21149 | 22 | Holder, for small spools..... | 50 |
| 21201 | 28 | Screw Driver, round steel (diameter $\frac{5}{32}$ inch, length over all nine inches)..... | 30 |
| 21202 | — | “ “ round steel (diameter $\frac{7}{32}$ inch, length over all 10 $\frac{3}{16}$ inches)..... | 40 |
| 21203 | — | “ “ round steel (diameter $\frac{7}{32}$ inch, length over all fifteen inches)..... | 50 |
| 21204 | — | “ “ round steel (diameter $\frac{1}{4}$ inch, length over all fifteen inches)..... | 60 |
| 21205 | — | “ “ octagon steel (diameter $\frac{5}{16}$ inch, length over all fifteen inches)..... | 75 |
| 21206 | 28 | “ “ Wrench, steel handle..... | 15 |
| 21207 | 28 | “ “ round steel (diameter $\frac{5}{64}$ inch, length over all 3 $\frac{7}{32}$ inches)..... | 10 |
| 21208 | 28 | “ “ chuck handle, including three blades..... | 1 25 |
| 21210 | 10 | Looper Collar (.040 inch thick)..... | 05 |
| 21211 | 10 | “ “ (.054 inch thick)..... | 05 |

[21225-21390 E]

PRICE LIST OF PARTS

THESE PARTS ARE FURNISHED AT LIST PRICES FOR REPAIRS ONLY.
SEE NOTICE ON PAGE 3.

| Number to order by | Plate No. | Postage will be charged on all parts sent by mail. Figures in second column refer only to plates illustrating parts, and are not to be used in ordering. Prices subject to change without notice. | Price per part |
|--------------------------|-----------|---|----------------|
| TERMS ON PARTS, NET CASH | | | |
| 21225 | 5 | Looper Gauge: | |
| 21225- $\frac{3}{16}$ | — | “ “ $\frac{3}{16}$ inch..... | \$0 20 |
| 21225- $\frac{7}{32}$ | — | “ “ $\frac{7}{32}$ inch..... | 20 |
| 21225- $\frac{1}{4}$ | — | “ “ $\frac{1}{4}$ inch..... | 20 |
| 21350 | 22 | Malleable Iron Belt Lacings, with two rows of teeth, for one-inch flat belt, per dozen..... | 15 |
| 21350 A | 22 | “ “ “ “ with three rows of teeth, for one-inch flat belt. per dozen..... | 15 |
| 21351 | — | Wire Belt Hooks, for $\frac{9}{32}$ -inch round belt, per five hundred ($\frac{1}{4}$ cent each in quantities less than five hundred) | 50 |
| 21355 | — | Chair Leg Extension (four inches long)..... | 08 |
| 21355 A | — | “ “ “ (six inches long)..... | 10 |
| 21355 B | — | “ “ “ (three inches long)..... | 08 |
| 21360 | — | Drive Bushing (ground, $\frac{7}{8}$ inch long, external diameter .319, .322, .325 and .328) for needle bar bearings.. | 15 |
| 21367 | — | Flat Head Stove Bolt, including nut and washer ($\frac{1}{4}$ x4 inches)..... | 03 |
| 21375 A | 28 | Oil Guard, for eccentric pulley..... | 1 00 |
| 21377 | — | Tray, or wooden base, for machine..... | 2 00 |
| 21388 | 22 | Wrench ($\frac{3}{8}$ inch, $3\frac{1}{2}$ inches long, hardened) for nuts Nos. 18, 34, 37 L, 37 R, 269, 462 and 1280..... | 15 |
| 21388 B | 22 | “ ($\frac{1}{2}$ inch, $4\frac{3}{8}$ inches long, hardened) for needle lever connection tube nuts. | 20 |
| 21388 F | 28 | “ steel handle, for nut No. 5144..... | 15 |
| 21390 | — | Needle Thread Intermittent Nipper Spring, complete (includes one each Nos. 87, 90, 97, 21390 A, 21390 B, 21390 D, 21390 E, 21390 F and 22564).. | 1 35 |
| 21390 A | 20 | Needle Thread Intermittent Nipper Spring, front..... | 15 |
| 21390 B | 20 | “ “ “ Nipper Spring, back..... | 12 |
| | | “ “ “ Nipper Spring Screw No. 22564..... | 04 |
| 21390 D | 20 | “ “ “ Nipper Spring Support... .. | 50 |
| | | “ “ “ Nipper Spring Support Screw No. 87..... | 04 |
| 21390 E | 20 | “ “ “ Nipper Spring Operating Block..... | 12 |
| | | “ “ “ Nipper Spring Operating Block Screw No. 90.... | 04 |

PRICE LIST OF PARTS

[21390 F-22560 B]

THESE PARTS ARE FURNISHED AT LIST PRICES FOR REPAIRS ONLY.
SEE NOTICE ON PAGE 3.

| Number to order by | Plate No. | Postage will be charged on all parts sent by mail. Figures in second column refer only to plates illustrating parts, and are not to be used in ordering. Prices subject to change without notice. | Price per part |
|--------------------------|-----------|--|----------------------|
| TERMS ON PARTS, NET CASH | | | |
| 21390 F | 20 | Needle Thread Intermittent Nipper Spring Operating Block Support..... | \$0 35 |
| | | “ “ “ Nipper Spring Operating Block Support Screw No. 97..... | 04 |
| 21394 | --- | Grinder Frame, including emery wheel (five inches diameter and $\frac{1}{4}$ -inch face, unless otherwise speci- fied) speed of wheel should be 3000 revolutions per minute..... | 3 50 |
| ‡ 21400 | --- | Expansion Reamer, complete, sizes .257, .260, .263, .266, .270, .273 and .276, for needle bar | 4 50 |
| ‡ 21408 | --- | “ “ complete, sizes .319, .322, .325 and .328, for presser bar and presser guide bar..... | 5 50 |
| ‡ 21420 | --- | Expansion Reamer, complete, sizes .407, .410 and .413, for feed rocker shaft, feed bar shaft and looper rock shafts..... | 6 00 |
| ‡ 21426 | --- | “ “ complete, sizes .530, .533 and .536, for main shaft..... | 7 50 |
| 21442 | --- | Taper Reamer, complete, for needle bar link pins and feed crank link pin..... | 1 50 |
| 21508 | --- | Tap (marked H2) for No. 22525..... | 50 |
| 21509 | --- | “ (marked J2) for No. 22526..... | 50 |
| 21513 | --- | “ (marked Q2) for No. 86 A..... | 50 |
| 21518 | --- | “ (marked X2) for No. 22521..... | 50 |
| 22516 | 8 | Screw, for spreader bar cross-head gibs..... | 04 |
| 22517 | 8 | “ for knife depresser bracket..... | 05 |
| 22521 | 8 | “ large size, for cloth plates (tap No. 21518)..... | 08 |
| 22522 | 8 | Clamp Screw, lower, for knife bar carrier fork..... | 06 |
| 22524 | 8 | Screw for stationary knife clamping plate, for knife grinder..... | 05 |
| 22525 | 8 | “ large size, diameter $\frac{5}{32}$ inch, for throat plates (tap No. 21508)..... | 05 |
| 22526 | 8 | “ large size, diameter $\frac{3}{16}$ inch, for throat plates (tap No. 21509)..... | 05 |
| 22529 | 8 | “ for needle thread pull-off and take-up wire posts, also for Nos. 10338 and 15435 C..... | 05 |
| 22539 | --- | “ for main shaft sponge hole..... | 10 |
| 22558 | 7 | Screw, for quilting guide and quilting guide support, also for No. 21113 B..... | 04 |
| 22560 | 7 | “ for needle bar link pin spring, also for Nos. 21102 and 21102 B..... | 03 |
| 22560 B | 7 | Set Screw, for grinder swinging frame stop collar..... | 04 |

‡ See Page No. 13

[22561-29402]

PRICE LIST OF PARTS

THESE PARTS ARE FURNISHED AT LIST PRICES FOR REPAIRS ONLY.
SEE NOTICE ON PAGE 3.

| Number to order by | Plate No. | Postage will be charged on all parts sent by mail. Figures in second column refer only to plates illustrating parts, and are not to be used in ordering. Prices subject to change without notice. | Price per part |
|--------------------------|-----------|---|----------------|
| TERMS ON PARTS, NET CASH | | | |
| 22561 | 7 | Screw, for stationary knife clamp..... | \$0 04 |
| 22562 | 7 | " for spring latch No. 1588..... | 04 |
| 22564 | 7 | " for needle thread intermittent nipper springs..... | 04 |
| 22569 | 8 | Clamp Screw, for needle bar bushings..... | 05 |
| 22570 | 7 | Screw, for shoe No. 14675..... | 05 |
| 22580 | 7 | " for thread guide holder, also for No. 21127..... | 03 |
| 22582 B | 7 | " for cloth plate guard No. 10333..... | 05 |
| 22585 | 7 | " for feed dog No. 3026 C, also for No. 6948 A..... | 04 |
| 22586 | 7 | " for needle lever stud..... | 05 |
| 22587 | 8 | " for needle lever connection bearings Nos. 15430 and 15430 E..... | 05 |
| 22591 | 7 | Set Screw, for knife grinder swinging frame..... | 06 |
| 22593 | 7 | Screw, for feed dogs Nos. 3005 F and 3005 M..... | 05 |
| 22597 | 7 | " for eccentric pulley..... | 03 |
| 22622 | 7 | " for spool support on Style C thread stand..... | 03 |
| 22730 | 7 | " for cloth plate guard No. 6035 A..... | 05 |
| 23168 B | 19 | Plate Hemmer, to make a $\frac{1}{4}$ -inch hem on upper side of fabric, for Style 6900 E..... | 1 75 |
| 23168 L | 19 | " " to make a $\frac{1}{8}$ -inch hem on upper side of fabric, for Style 6900 E..... | 1 75 |
| 23254 C | 19 | Folder, for Style 6900 H (uses strip $\frac{11}{16}$ inch wide)..... | 4 00 |
| 23254 D | 19 | " for side buckle straps: | |
| 23254 D- $\frac{11}{16}$ | — | " for $\frac{11}{16}$ -inch strap (uses strip $1\frac{3}{8}$ inches wide)... | 4 50 |
| 23254 E | 19 | " for Style 6900 H (uses strip $\frac{11}{16}$ inch wide) for light-weight material..... | 4 00 |
| 23254 F | 19 | " for Style 6900 H (uses strip $\frac{3}{4}$ inch wide) for corduroy and heavy-weight material..... | 4 00 |
| | | " Screws No. 25 C..... | 05 |
| 29051 A | — | Nos. 59 S and 15430, assembled and lapped together... | 3 00 |
| 29066 A | — | Nos. 15430 E and 156, assembled and lapped together... | 1 35 |
| 29116 | — | Nos. 10363 and two each Nos. 10364 and 10349, assembled and lapped together..... | 6 80 |
| 29304 B | — | Nos. 153 F and 1275 A, assembled and lapped together.. | 3 90 |
| 29317 A | — | Nos. 10315 and 1275 A, assembled and lapped together.. | 3 90 |
| 29331 | — | Nos. 6915 G and 1275 A, assembled and lapped together | 4 00 |
| 29402 | — | Nos. 422, 98, 423 and 424, assembled..... | 40 |

UNION SPECIAL
TRADE DOUBLE MARK
LOCKED
STITCH