



FINEST QUALITY

Union Special[®]

LEWIS • COLUMBIA

INDUSTRIAL
SEWING
MACHINES

CLASSES

7000
7200
7400
7500
7800
8200
8300

**LIST OF PARTS
STYLES IN CLASS**

7000	7500
7200	7800
7400	8200
8300K	

**CATALOG
NO.
59L**

Union Special MACHINE COMPANY

CHICAGO

Catalog No. 59 L

LIST OF PARTS

STYLES IN CLASSES

7000 7200 7400 7500
7800 8200 8300 K

Copyright 1927

By

Union Special Machine Co.
Rights Reserved in All Countries

Union Special

MACHINE COMPANY

INDUSTRIAL SEWING MACHINES

CHICAGO

Printed in U.S.A.

July, 1967

APPLICATION OF CATALOG

This catalog applies only to the standard styles of machines listed below, but can be applied with discretion to the special machines in Classes 7000, 7200, 7400, 7500, 7800, 8200, 8300. Information relative to transmitters is contained in Catalog No. 29 and pullers in Catalog No. 32. Needles are listed and fully described in Catalog No. 45. These catalogs will be furnished, gratis, on request.

Styles	Styles	Styles	Styles
7000 A-2	7200 T-4	7500 X-3	8200 E-3
7000 A-3	7400 A-1	7500 X-4	8200 E-4
7000 A-4	7400 A-2	7500 X-4 $\frac{1}{2}$	8200 E-4 $\frac{1}{4}$
7000 A-4 $\frac{1}{4}$	7400 A-3	7500 X-5	8200 E-4 $\frac{1}{2}$
7000 A-4 $\frac{1}{2}$	7400 A-4	7800 A-5	8200 E-5
7000 A-5	7400 A-4 $\frac{1}{2}$	7800 A-5 $\frac{1}{2}$	8200 M-00
7000 A-5 $\frac{1}{2}$	7400 B-4	7800 A-6	8200 M-0
7000 G-4 $\frac{1}{4}$	7400 B-4 $\frac{1}{2}$	7800 A-32	8200 M-1
7000 G-4 $\frac{1}{2}$	7400 B-5	7800 A-40	8200 M-2
7000 G-5	7400 B-5 $\frac{1}{2}$	7800 A-48	8200 M-3
7000 G-5 $\frac{1}{4}$	7400 B-6	7800 B-5	8200 M-4
7000 G-5 $\frac{1}{2}$	7400 N-4	7800 B-5 $\frac{1}{2}$	8200 M-4 $\frac{1}{4}$
7000 G-6	7400 N-4 $\frac{1}{2}$	7800 B-6	8200 M-4 $\frac{1}{2}$
7000 G-28	7400 N-5	7800 B-40	8200 N-5
7000 G-30	7400 N-5 $\frac{1}{2}$	7800 B-48	8200 O-1
7000 G-32	7400 N-6	7800 C-5	8200 O-2
7000 G-34	7400 N-32	7800 C-5 $\frac{1}{2}$	8200 O-3
7000 G-36	7400 N-36	7800 C-6	8200 O-4
7000 G-40	7400 N-40	7800 C-32	8200 O-4 $\frac{1}{4}$
7000 G-44	7400 U-48	7800 C-40	8200 O-4 $\frac{1}{2}$
7000 G-48	7400 V-48	7800 C-48	8200 S-1
7200 A-1	7400 W-48	7800 D-5	8200 S-2
7200 A-2	7400 X-48	7800 D-5 $\frac{1}{2}$	8200 S-3
7200 A-3	7400 Y-48	7800 D-6	8200 T-0
7200 A-4	7400 AA-48	7800 D-40	8200 T-1
7200 A-4 $\frac{1}{4}$	7400 AF-48	7800 D-48	8200 T-2
7200 A-4 $\frac{1}{2}$	7400 AG-4 $\frac{1}{2}$ - $\frac{1}{8}$	7800 F-4 $\frac{1}{2}$	8200 T-3
7200 A-5	7400 AG-4 $\frac{1}{2}$ - $\frac{1}{4}$	8200 A-1	8200 T-4
7200 C-1	7400 AG-5- $\frac{1}{8}$	8200 A-2	8200 T-4 $\frac{1}{4}$
7200 C-2	7400 AG-5- $\frac{1}{4}$	8200 A-3	8200 T-4 $\frac{1}{2}$
7200 C-3	7400 AH-48	8200 A-4	8200 T-5
7200 C-4	7400 AJ-48	8200 A-4 $\frac{1}{4}$	8200 T-5 $\frac{1}{4}$
7200 C-4 $\frac{1}{4}$	7400 AK-48	8200 A-4 $\frac{1}{2}$	8200 T-5 $\frac{1}{2}$
7200 C-4 $\frac{1}{2}$	7400 AM-48	8200 C-1	8200 V-1
7200 C-5	7400 AN-48	8200 C-2	8200 V-2
7200 S-1	7500 B-4	8200 C-3	8200 V-3
7200 S-2	7500 B-4 $\frac{1}{2}$	8200 C-4	8200 V-4
7200 S-3	7500 B-5	8200 C-4 $\frac{1}{4}$	8200 W-3
7200 T-1	7500 B-5 $\frac{1}{2}$	8200 C-4 $\frac{1}{2}$	8200 W-4
7200 T-2	7500 B-6	8200 E-1	8300 K-4
7200 T-3	7500 T-3	8200 E-2	8300 K-4 $\frac{1}{2}$

IDENTIFICATION OF MACHINES

A machine equipped with specified parts and fitted for a specific operation is given a STYLE NUMBER, the symbol for which is a number evenly divisible by 100, with one or more letters suffixed. Example: 7000 A. Style numbers are classified as STANDARD and SPECIAL. Those which are standard do not include the letter Z, while those including the letter Z are special. When only minor changes are made a Z is merely suffixed to the respective standard style number. Example: 7000 AZ. (See description of 7000 Z).

Styles of machines, similar in construction, are grouped and given a CLASS NUMBER, the symbol for which is a number evenly divisible by 100, without a letter suffixed. Example: 7000.

The distance between the rows of stitches is represented by a gauge number. Those which apply to machines described in this catalog are as follows:

No. 00	gauge represents	$\frac{3}{64}$ inch
No. 0	gauge represents	$\frac{1}{16}$ inch
No. 1	gauge represents	$\frac{3}{32}$ inch
No. 2	gauge represents	$\frac{1}{8}$ inch
No. 3	gauge represents	$\frac{5}{32}$ inch
No. 4	gauge represents	$\frac{3}{16}$ inch
No. $4\frac{1}{4}$	gauge represents	$\frac{7}{32}$ inch
No. $4\frac{1}{2}$	gauge represents	$\frac{1}{4}$ inch
No. 5	gauge represents	$\frac{9}{32}$ inch
No. $5\frac{1}{4}$	gauge represents	$\frac{2}{8}$ inch
No. $5\frac{1}{2}$	gauge represents	$\frac{3}{8}$ inch
No. 6	gauge represents	$\frac{1}{3}$ inch

For all other needle spacing the gauge number is the same as the actual number of sixty-fourths of an inch. Example: 32 gauge represents $\frac{3}{8}$ inch, or one-half inch; 64 gauge represents $\frac{6}{4}$ inch, or one inch.

STYLES OF MACHINES IN CLASS 7000

Flat Bed Two Needle Machines, Two Loopers, Left Needle in Front,
 $\frac{3}{16}$ -inch Space Between Centers of Loopers, Bed 13 Inches
Long, Double Locked Stitch, for Knitted Goods

7000 A For drawer finishing; no feed surface between needles.

7000 G For attaching selvage edge tape to upper surface of knitted garments; feed surface between needles.

7000 Z A special style similar to the standard styles in Class 7000 having several of the standard parts substituted by corresponding parts or equipped with additional parts.

STYLES OF MACHINES IN CLASS 7200

Flat Bed Two Needle Machines, Two Loopers, Left Needle in Front,
 $\frac{3}{16}$ -inch Space Between Centers of Loopers, Bed 13 Inches
Long, Double Locked Stitch, for Shoe Work

- 7200 A For staying; no feed surface between needles, rigid bottom presser foot with keel.
- 7200 C For staying; no feed surface between needles, hinged bottom presser foot with keel.
- 7200 S For seaming shoe linings; double stitch single felled seam.
- 7200 T For staying; no feed surface between needles, rigid bottom presser foot with keel, stay cutting mechanism.
- 7200 Z A special style similar to the standard styles in Class 7200 having several of the standard parts substituted by corresponding parts or equipped with additional parts.

STYLES OF MACHINES IN CLASS 7400

Flat Bed Two Needle Machines, Two Loopers, Left Needle in Front,
 $\frac{3}{16}$ -inch Space Between Centers of Loopers, Bed 13 Inches
Long, Double Locked Stitch for Light Weight
Woven and Knitted Fabrics

- 7400 A For piecing sleeves of shirts and similar garments; double stitch felled seam, no feed surface between needles.
- 7400 B For setting sleeves and joining shoulders of shirts and similar garments; double stitch felled seam, feed surface between needles.
- 7400 N For folding and stitching a tape to the upper surface of garments.
- 7400 U For folding and stitching two piece facings to sleeves of shirts and similar garments; one operation, $\frac{1}{16}$ -inch margins.
- 7400 V For folding and stitching extension center plait and facing strip to fronts of shirts and similar garments; one operation, plaits used in garment lengths and extend $\frac{1}{4}$ inch beyond the rows of stitching, lining strip used in long lengths, starts operation at neck.
- 7400 W Finishes operation at neck, otherwise same as Style 7400 V.

STYLES OF MACHINES IN CLASS 7400 (Cont'd)

- 7400 X Uses an interlining strip, otherwise same as Style 7400 V.
- 7400 Y Finishes operation at neck and uses an interlining strip, otherwise same as Style 7400 V.
- 7400 AA For folding and stitching two piece extension button stay to shirts and similar garments; one operation, $\frac{1}{16}$ -inch margins upper strip used in garment lengths, under strip used in long lengths, starts operation at neck.
- 7400 AF Finishes operation at neck and fitted with a suspended upper folder, otherwise same as Style 7400 V.
- 7400 AG For hemming bloomers and similar garments made from rayon or art silk knitted fabrics, and inserting elastic band under constant tension, INCLUDES PULLER NO. 21700 V; one operation, hem turned on under surface of fabric, elastic used in long lengths.
- 7400 AH For folding and stitching set-on center plait and interlining strip to fronts of shirts and similar garments; one operation, plaits used in garment lengths and extend $\frac{1}{4}$ inch beyond the rows of stitching, starts operation at neck, quilting guide for maintaining accurate spacing of stripes.
- 7400 AJ For set-on button stay without interlining strip, otherwise same as Style 7400 AH.
- 7400 AK For folding and stitching single piece facings to sleeves of shirts and similar garments; one operation, facing used in garment lengths.
- 7400 AM Equipped with puller Style 21700 W, otherwise same as Style 7400 X.
- 7400 AN Equipped with puller Style 21700 W, otherwise same as Style 7400 AH.
- 7400 Z A special style similar to the standard styles in Class 7400 having several of the standard parts substituted by corresponding parts or equipped with additional parts.

STYLES OF MACHINES IN CLASS 7500

Flat Bed Two Needle Machines, Two Loopers, Left Needle in Front,
 $\frac{3}{16}$ -inch Space Between Centers of Loopers, Bed 13
Inches Long, Double Locked Stitch, for
Medium Weight Woven Fabrics

- 7500 B For seaming overalls, coats and similar articles; double stitch felled seam, feed surface between needles.
- 7500 T For binding bed blankets; with selvage edge or pre-folded strip.
- 7500 X For attaching curtain and waist band to French waist trousers; one operation, canvas used in long lengths.
- 7500 Z A special style similar to the standard styles in Class 7500 having several of the standard parts substituted by corresponding parts or equipped with additional parts.

STYLES OF MACHINES IN CLASS 7800

Flat Bed Two Needle Machines, Two Loopers, Left Needle in Front,
 $\frac{3}{16}$ -inch Space Between Centers of Loopers, Bed 13
Inches Long, Double Locked Stitch, for
Heavy Weight Woven Fabrics

- 7800 A For seaming tents, awnings, covers and similar articles; lap seam.
- 7800 B Makes double stitch felled seam, otherwise same as Style 7800 A.
- 7800 C Includes Puller Style 21700 A; otherwise same as Style 7800 A.
- 7800 D For seaming tents, awnings, covers and similar articles; double stitch felled seam, includes Puller Style 21700 A.
- 7800 F For attaching auto top decks to quarters; includes Puller Style 21700 T.
- 7800 Z A special style similar to the standard styles in Class 7800 having several of the standard parts substituted by corresponding parts or equipped with additional parts.

STYLES OF MACHINES IN CLASS 8200

Flat Bed Two Needle Machines, Two Loopers, Right Needle in Front, $\frac{1}{8}$ -inch Space Between Centers of Loopers, Bed 13 Inches Long, Double Locked Stitch, for Shoe Work

- 8200 A For staying; no feed surface between needles, rigid bottom presser foot.
- 8200 C Has hinged bottom presser foot, otherwise same as Style 8200 A.
- 8200 E For attaching outside leather stays to shoes; no feed surface between needles.
- 8200 M For tip stitching; no feed surface between needles, adjustable guide on left-hand side of presser foot.
- 8200 N Has feed surface between needles, otherwise same as Style 8200 M.
- 8200 O Has guide on right-hand side of presser foot, otherwise same as Style 8200 M.
- 8200 S For seaming shoe linings; double stitch single felled seam.
- 8200 T For vamping; has rolling presser foot.
- 8200 V For staying; rigid bottom presser foot with keel, stay cutting mechanism.
- 8200 W For imitation tip stitching and eyelet row stitching; continuous stay strip guided under perforations.
- 8200 Z A special style similar to the standard styles in Class 8200 having several of the standard parts substituted by corresponding parts or equipped with additional parts.

STYLES OF MACHINES IN CLASS 8300

Flat Bed Two Needle Machines, Two Loopers, Right Needle in Front, $\frac{1}{8}$ -inch Space Between Centers of Loopers, Bed 13 Inches Long, Double Locked Stitch, for Shirt Work

- 8300 K For miscellaneous gathering operations; differential feed gathering mechanism.
- 8300 Z A special style similar to the standard styles in Class 8300 having several of the standard parts substituted by corresponding parts or equipped with additional parts.

NEEDLES

TYPE NUMBER Each needle has a type number and size number.
DESCRIPTIONS The former denotes the kind of point, shank, length, groove, finish and other details. The latter denotes the largest diameter of the blade, measured in thousandths of an inch, midway between the shank and eye, and is stamped in the needle shank. Collectively, the Type Number and Size Number represent the complete definition of the needle.

The type numbers of the needles used in the machines covered by this catalog are listed below. Set opposite each type number is the definition of the needles.

DESCRIPTION

Type No.

- 101 Round shank, round point, extra short, double groove, nickel plated.
- 106 Round shank, round point, extra short, double groove, ball eye, nickel plated.
- 107 Round shank, round point, extra short, double groove, ball eye, short blade, nickel plated.
- 108 Round shank, round point, extra short, double groove, ball eye, spotted, nickel plated.
- 109 Round shank, round point, extra short, double groove, ball eye, government, nickel plated.
- 121 Round shank, round point, short, double groove, nickel plated.
- 126 Round shank, round point, short, double groove, ball eye, spotted, nickel plated.
- 130 Round shank, round point, short, double groove, ball eye, spotted, government, nickel plated.
- 143 Round shank, round point, No. 2 Bag, double groove, nickel plated.
- 301 Round shank, stay point, extra short, double groove.
- 501 Round shank, rocked point, extra short, double groove.
- 907 Round shank, spear point, extra short, double groove, ball eye, nickel plated.
- 929 Round shank, spear point, short, double groove, ball eye, spotted, nickel plated.
- 943 Round shank, spear point, No. 2 Bag.

NEEDLES (Cont'd)

Type No.

- 1101 Round shank, cross point, extra short, double groove.
- 1301 Round shank, narrow cross taper point, extra short, double groove.
- 1501 Round shank, twist point, extra short, double groove.

APPLICATION OF TYPE NUMBERS The styles of machines covered by this catalog are listed herewith. Set opposite each style number are type numbers of needles generally used.

Machine Style Nos.	Type Nos. of Needles Used
7000 A	121
7000 C	121
7000 G	121
7000 N	121
7200 A	501, 1101, 1301
7200 B	501, 1101, 1301
7200 C	501, 1101, 1301
7200 D	501, 1101, 1301
7200 S	106, 1502
7200 T	501, 1101, 1301
7400 A	106, 107, 108, 109, 907
7400 B	106, 107, 108, 109, 907
7400 N	106, 107, 108, 109, 907
7400 U	106, 107, 108, 109, 907
7400 V	106, 107, 108, 109, 907
7400 W	106, 107, 108, 109, 907
7400 X	106, 107, 108, 109, 907
7400 Y	106, 107, 108, 109, 907
7400 AA	106, 107, 108, 109, 907
7400 AF	106, 107, 108, 109, 907
7400 AG	101, 106
7400 AH	106, 107, 108, 109, 907
7400 AJ	106, 107, 108, 109, 907
7400 AK	106, 107, 108, 109, 907
7400 AM	106, 107, 108, 109, 907
7400 AN	106, 107, 108, 109, 907
7500 B	126, 128, 130, 929
7500 T	121, 126, 128
7500 X	126, 128
7800 A	143, 943
7800 B	143, 943
7800 C	143, 943
7800 D	143, 943
7800 F	128, 929

NEEDLES (Cont'd)

Application of Type Numbers (Cont'd)

Machine Style Nos.	Type Nos. of Needles Used
8200 A	501, 1101, 1301
8200 B	501, 1101, 1301
8200 C	501, 1101, 1301
8200 D	501, 1101, 1301
8200 E	301, 501, 1101, 1301
8200 M	301, 501, 1101, 1301
8200 N	301, 501, 1101, 1301
8200 O	301, 501, 1101, 1301
8200 P	301, 501, 1101, 1301
8200 S	106, 1502
8200 T	301, 501, 1101, 1301
8200 V	301, 501, 1101, 1301
8200 W	301, 501, 1101, 1301
8300 K	106

USE GENUINE NEEDLES Success in the operation of these machines can be secured only by the use of genuine Union Special Needles, as furnished by the Union Special Machine Company, or its subsidiaries. Obviously, it is to our interest to maintain the reputation of machines by furnishing the very best needles obtainable. They are designed according to the most approved scientific principles and are made with the utmost precision. The maximum efficiency and durability are assured.

Genuine needles are put up in packages marked at the top "Trade 'UNION SPECIAL' mark". All other needles are bogus.

ORDERING To have orders promptly and accurately filled, the empty package, a sample needle, or the Type and Size Numbers should be given. See marks on package. An intelligible order would read as follows:

100 Needles, Type 101, Size .040

ORDERING REPAIR PARTS

PLATES Illustrations of parts similar in appearance and size are shown in groups.

LIST OF PARTS Turning from the plates to the list of parts, the definition of each part and its principal uses will be found. Always check the symbol against its definition before ordering. It is not necessary to furnish the plate number.

When a part is used or can be used in all machines covered by this catalog, no specific use is mentioned in the definition.

For convenience in ordering, minor parts such as screws, nuts, and similar articles are repeated after each major part.

(—) A dash in the "plate number" column of the list of parts indicates the absence of an illustration.

(□) A square in the "Symbol to order by" column indicates that the part is commercial and can be readily purchased in any machinists' supply house.

(‡) A double dagger in the "Symbol to order by" column indicates that the component parts cannot be furnished separately.

IDENTIFYING PARTS Where the construction permits, each part is stamped with its part number. Some of the smaller parts are stamped with an identification letter to distinguish them from parts similar in appearance.

All part numbers represent the same part regardless of the catalog in which they appear.

SUPPLIES All supplies, including taps, reamers, belting, belt hooks, belt fasteners, screw drivers and powdered oil stone will be promptly furnished.

TERMS Prices are strictly net cash and subject to change without notice. Express and freight shipments are forwarded at the buyer's risk, f. o. b. shipping point. Parcel post shipments are insured unless otherwise directed. A charge is made to cover the postage and insurance.

Plate 1—Full Size

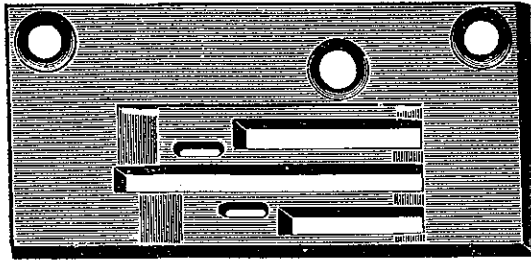

7524 B

Specify Gauge

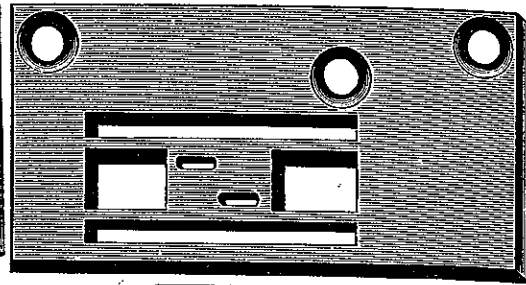

7524 C

Specify Gauge

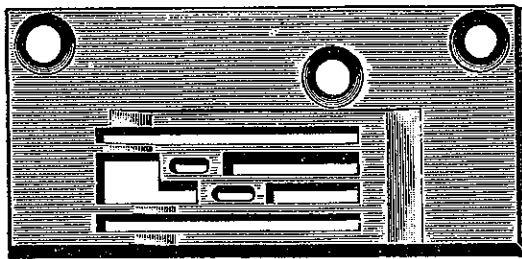

7424

Specify Gauge

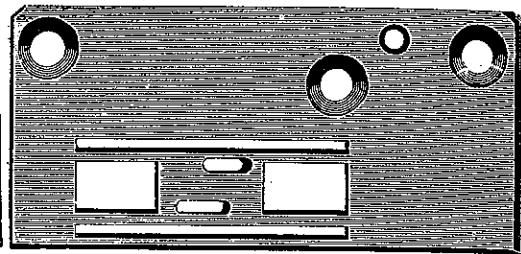

185 A

Specify Gauge

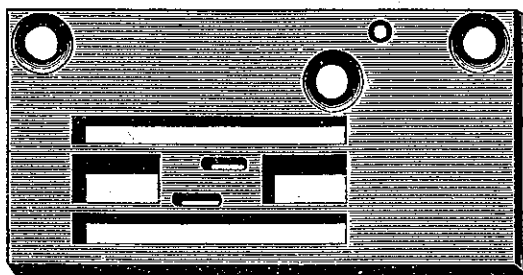

8224

Specify Gauge

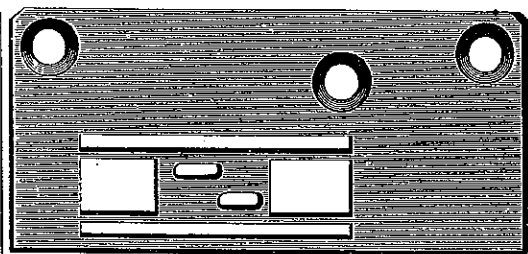

195 A

Specify Gauge

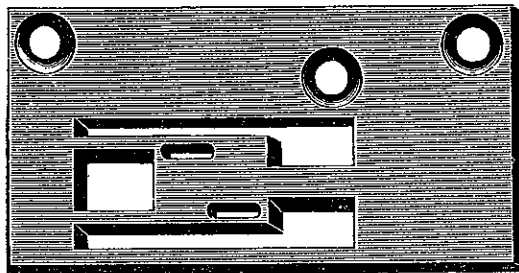

7024 C

Specify Gauge

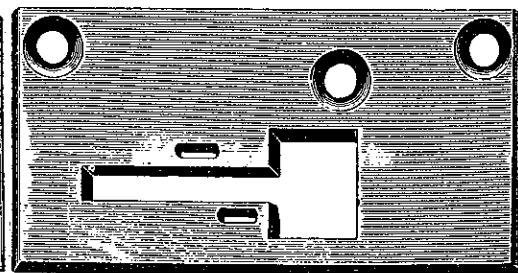

195 AT

Specify Gauge

Plate 2—Full Size

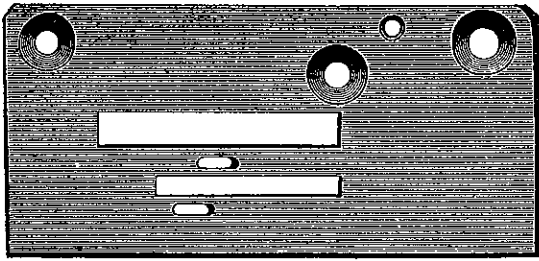

185B

Specify Gauge

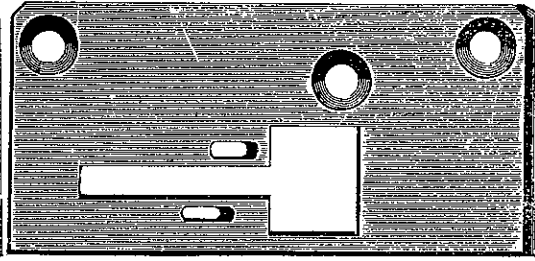

185AT

Specify Gauge

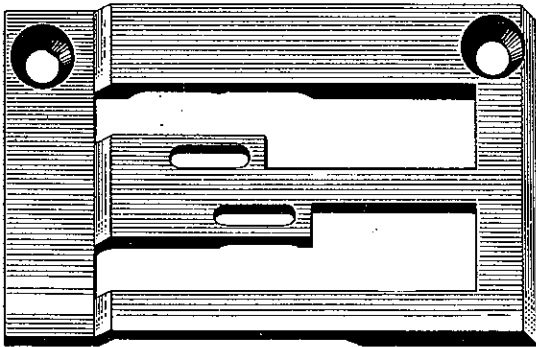

7824A

Specify Gauge

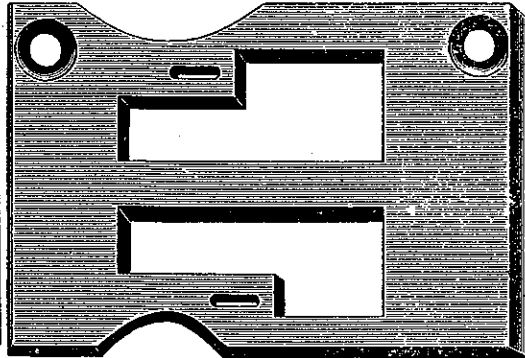

7024H

Specify Gauge

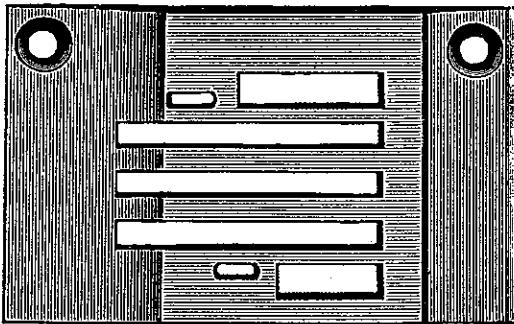

7424T-48

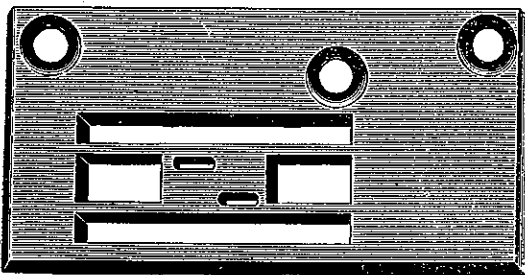

7224R

Specify Gauge

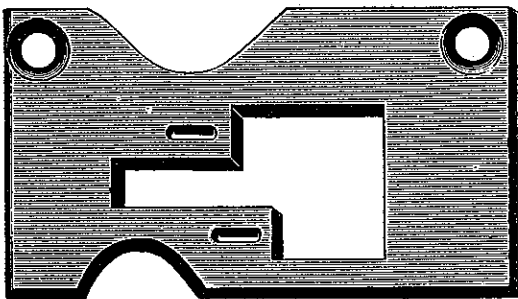

7024G

Specify Gauge

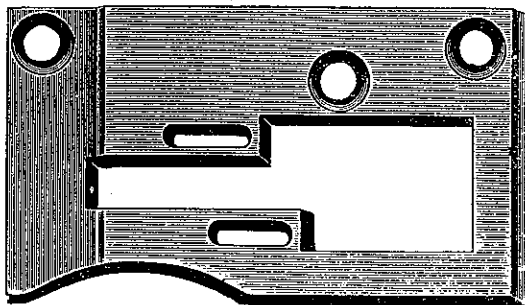

195Y

Specify Gauge

Plate 3—Full Size

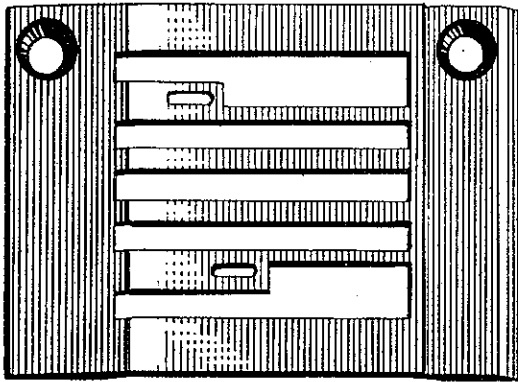

7424 S-48

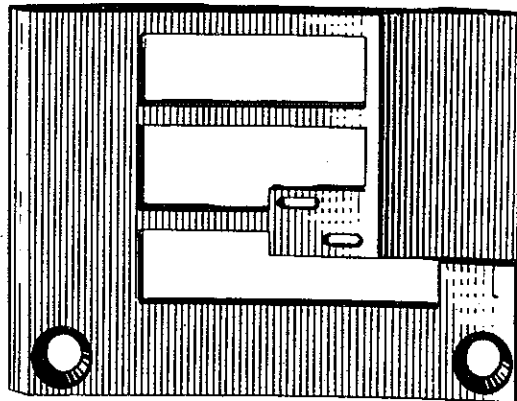

7428 B-3

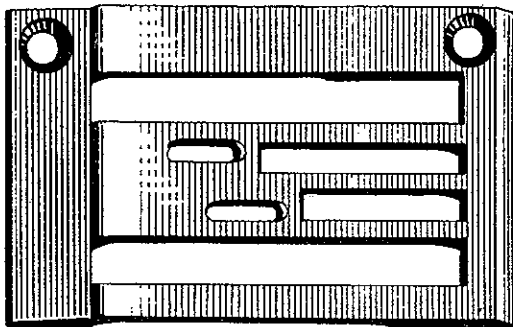

7824 F-4 1/2

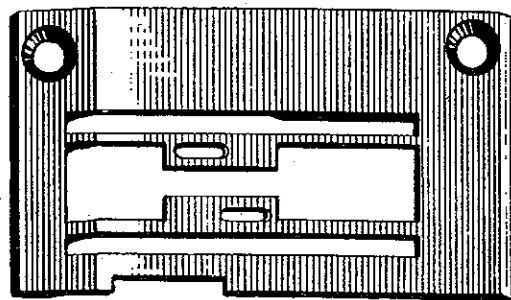

7424 AG-5

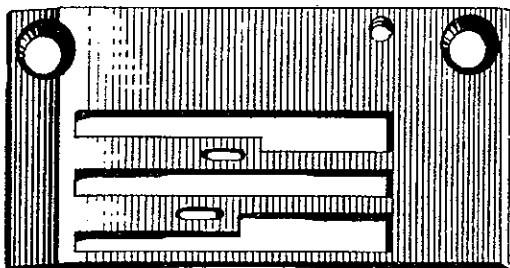

8324 L

Specify Gauge

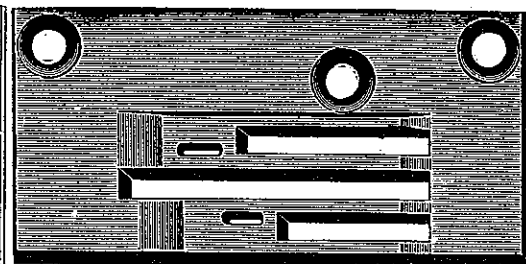

7424 B

Specify Gauge

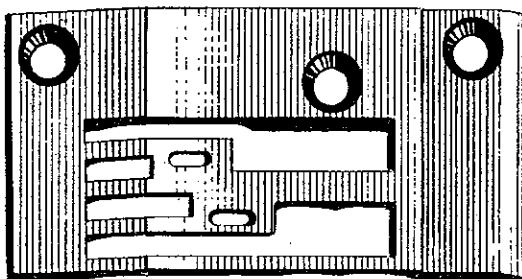

7528 H-4 1/2

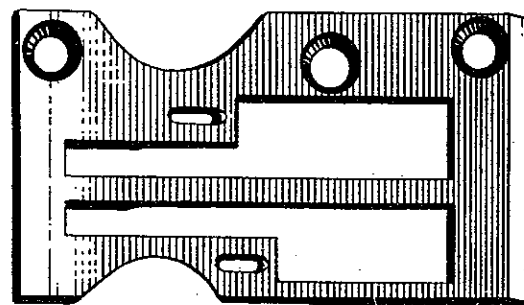

7528 B-40

Plate 4—Full Size

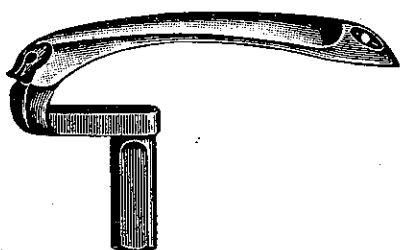

8309 C-4 1/2

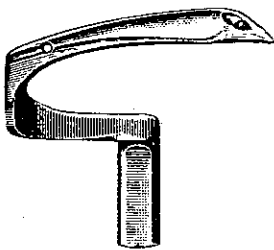

7009E-48

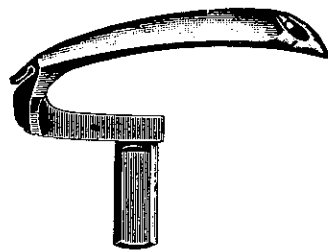

7209-1

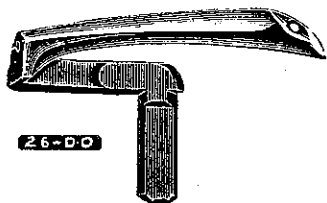

26-D-0

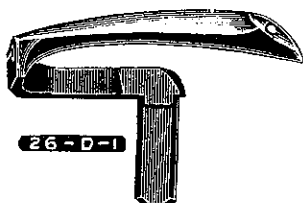

26-D-1

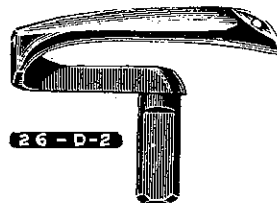

26-D-2

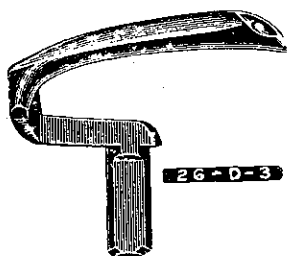

26-D-3

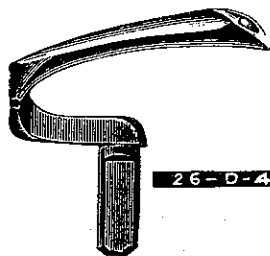

26-D-4

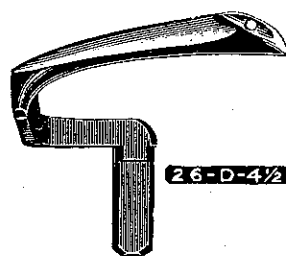

26-D-4 1/2

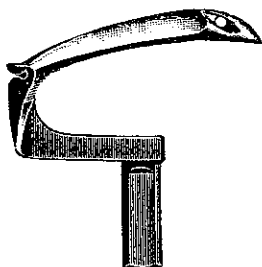

7009 E-36

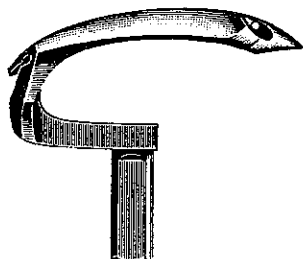

7009 E-40

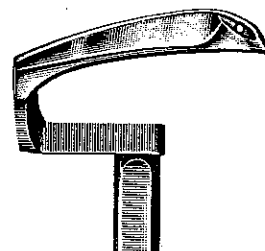

7009E-32

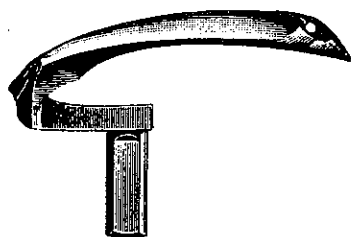

178 B
Specify Gauge

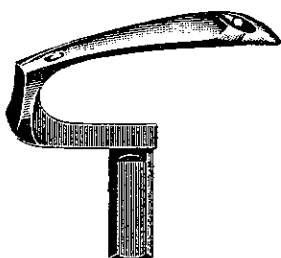

7009 E-30

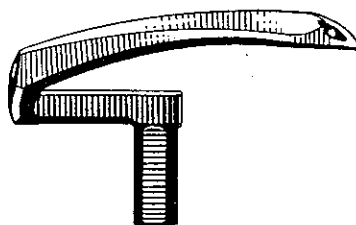

7408-48

Plate 5—Full Size

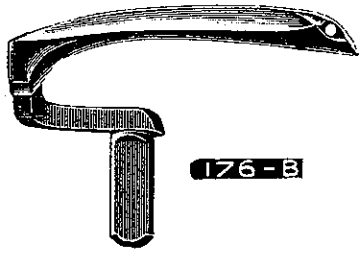

176-B

Specify Gauge

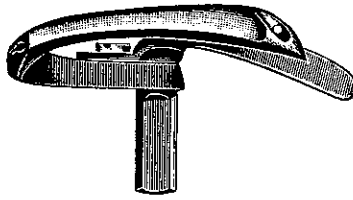

26 M-1

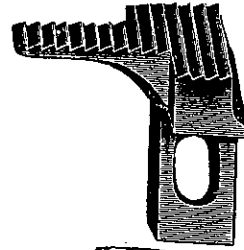

7005 G

Specify Gauge

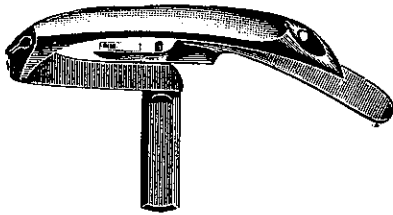

178

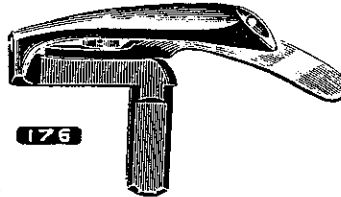

176

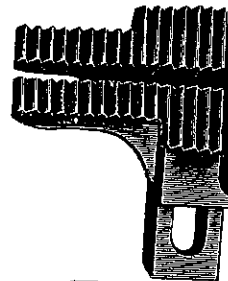

7005 H

Specify Gauge

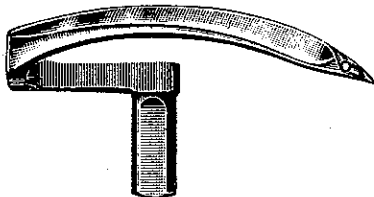

7008E-48

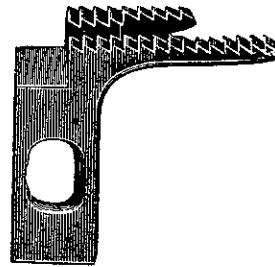

174A

Specify Gauge

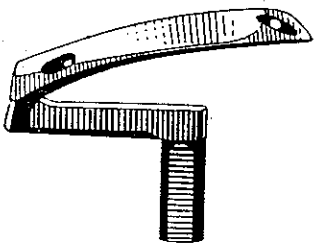

7809

Specify Gauge

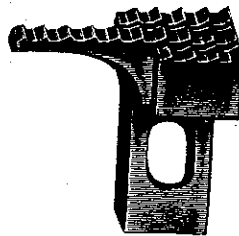

7505 C

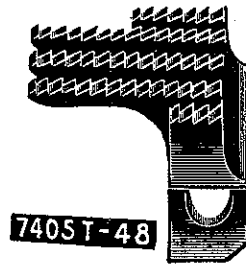

7405T-48

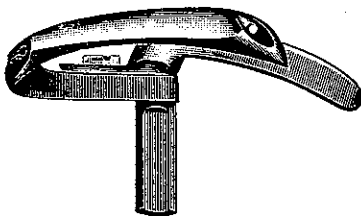

26 M-2

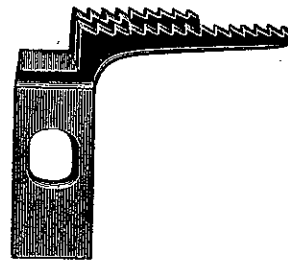

173A

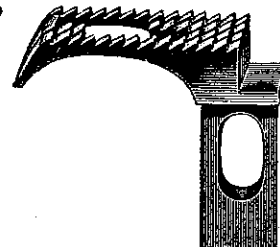

7405-1

Plate 6—Full Size

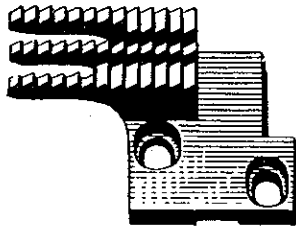

8305 S

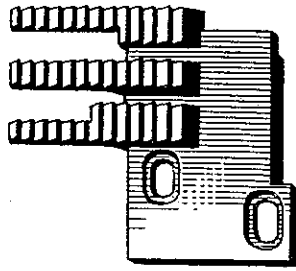

8305 L

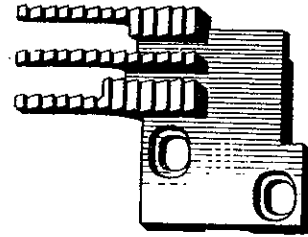

8305 N

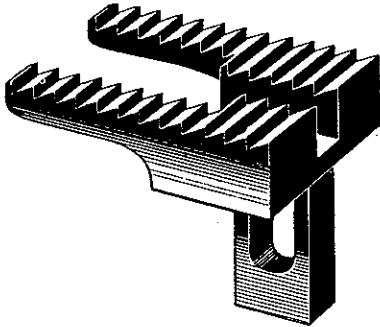

7805A

Specify
Gauge

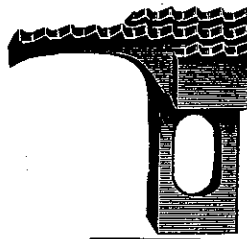

7505

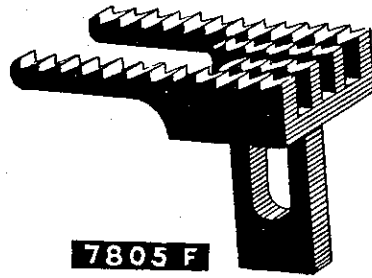

7805 F

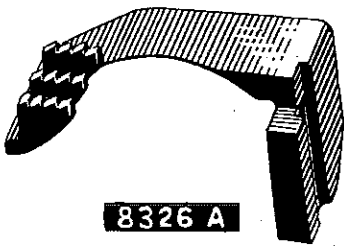

8326 A

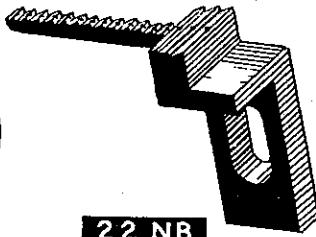

22 NB

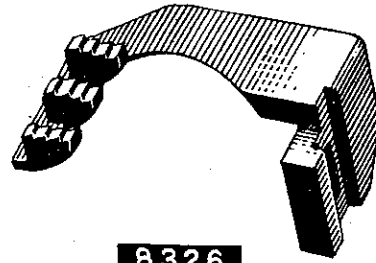

8326

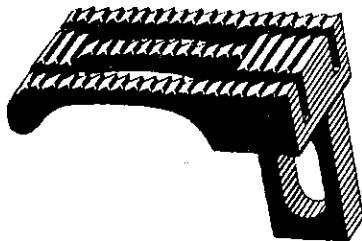

7405 AG-5

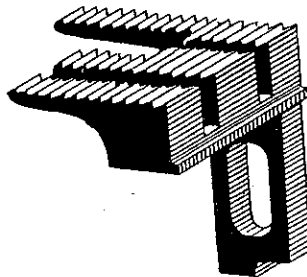

7426 B

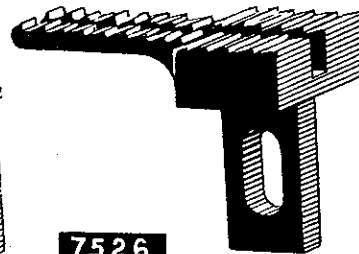

7526

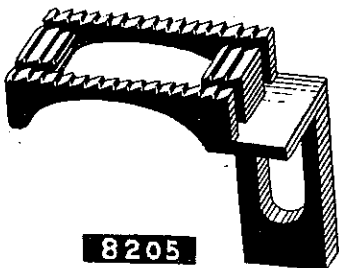

8205

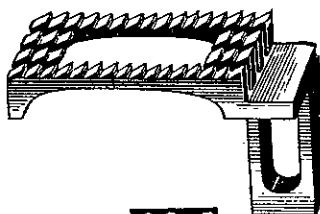

22 J

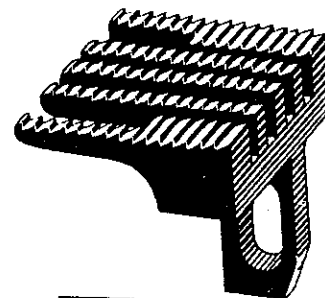

7405 S-48

Plate 7—Full Size

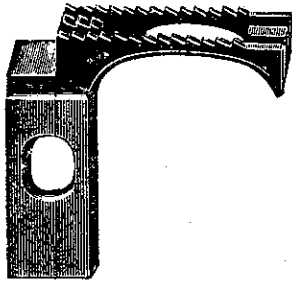

197 C

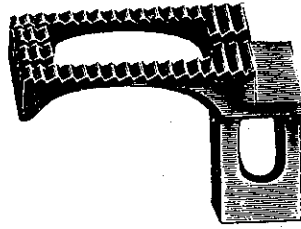

7005 A
Specify
Gauge

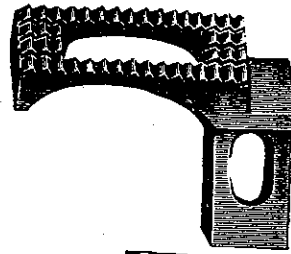

6905 C

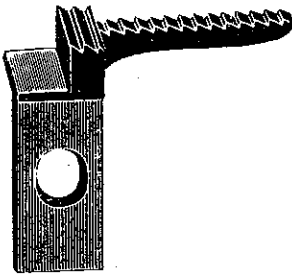

22 N

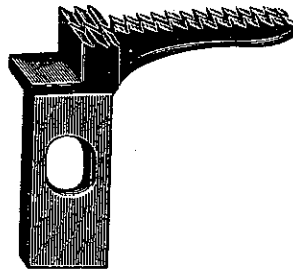

22 N A

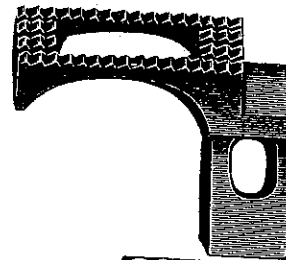

22 J E

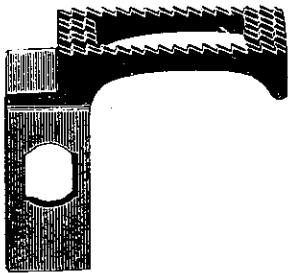

22 J W

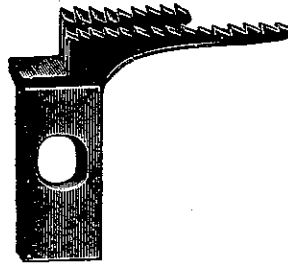

173 B

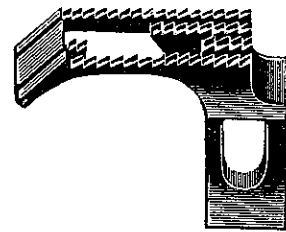

7405-4 1/2

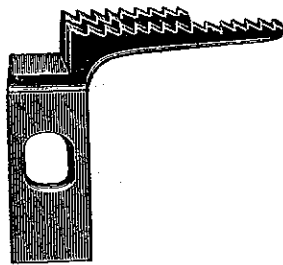

173 A

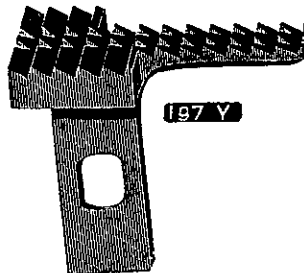

197 Y

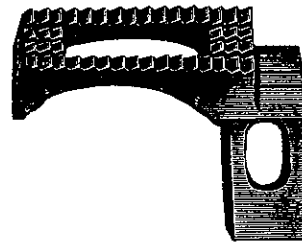

7205 A

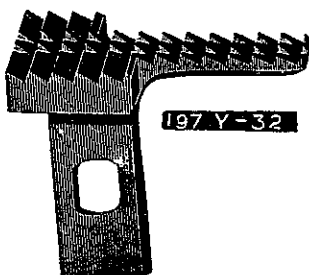

197 Y-32

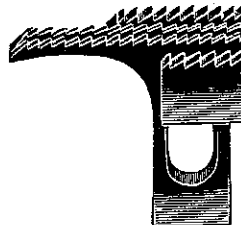

7405 B
Specify
Gauge

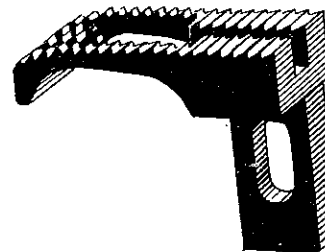

7505 M-4 1/2

Plate 8—Full Size



198 A

Specify Gauge



198 B

Specify Gauge

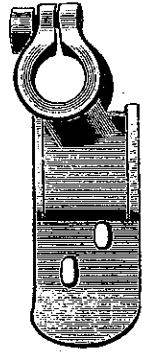

198 C

Specify Gauge



65 B.N

Specify Gauge



503 C

Specify Gauge



8220 S

Specify Gauge

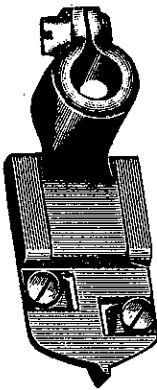

8220

Specify Gauge

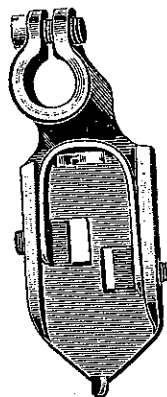

503 A

Specify Gauge

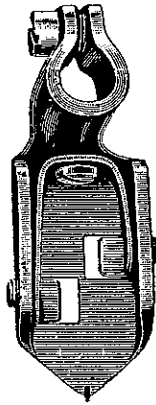

65 Q

Specify Gauge



65 QH

Specify Gauge

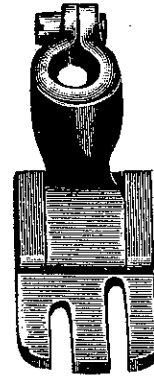

7020 B

Specify Gauge



8219

Specify Gauge

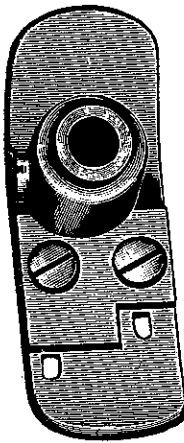

7827 A

Specify Gauge

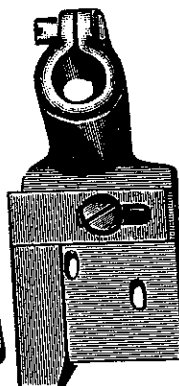

8220 M

Specify Gauge

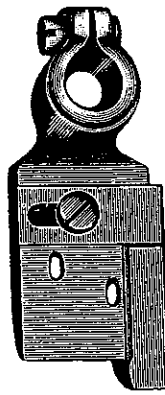

8220 O

Specify Gauge

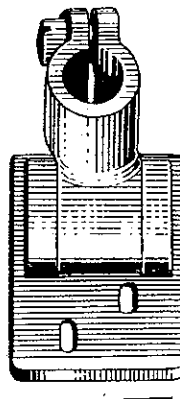

7420 AG

Specify Gauge

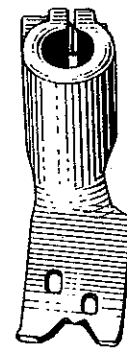

8220 W

Specify Gauge

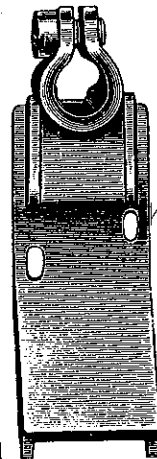

65BT

Specify Gauge

Plate 9—Full Size

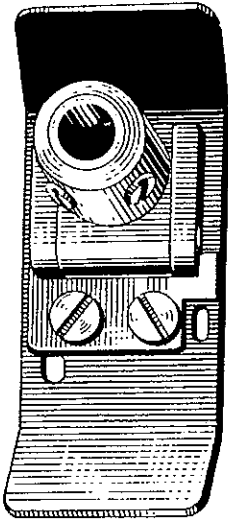

7820 C-40

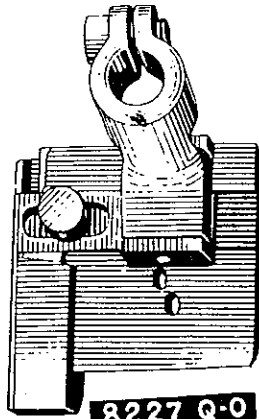

8227 Q-0

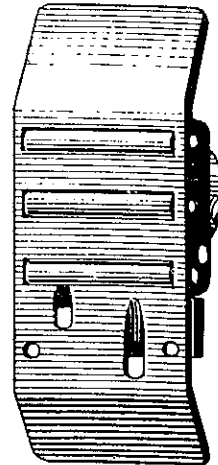

7827 B 4 1/2

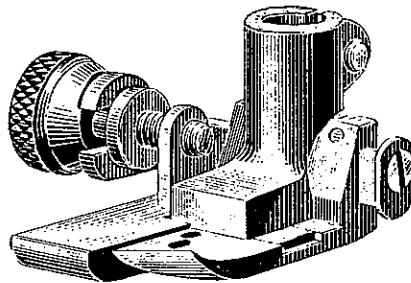

8227 P-00

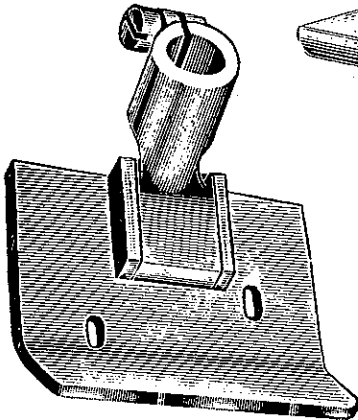

8020-48



188 A.O

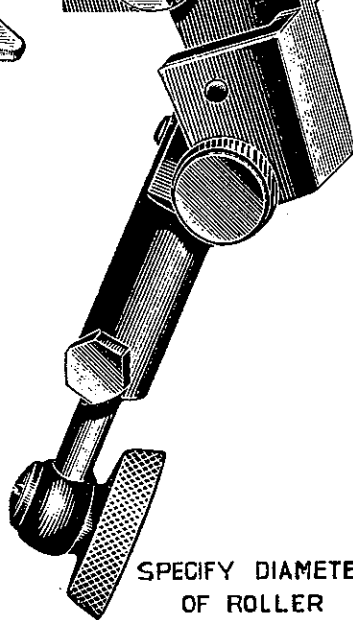
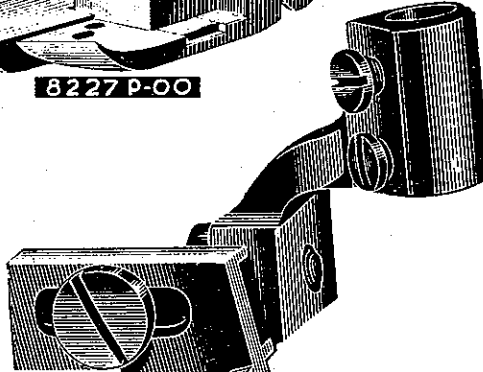

SPECIFY DIAMETER
OF ROLLER

1520 M

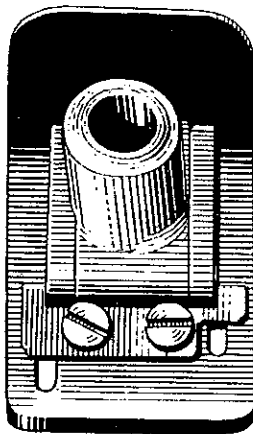

7827 C-48

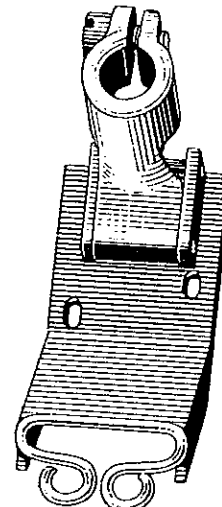

7020 E
Specify
Gauge

Plate 10—Full Size

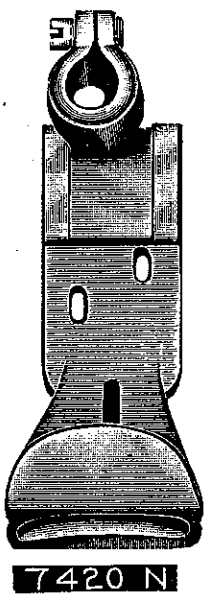
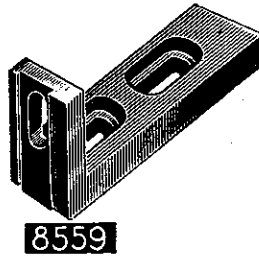
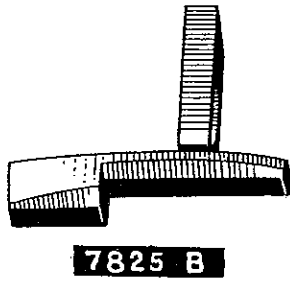
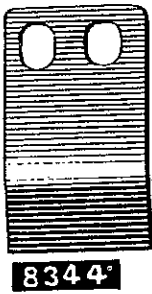
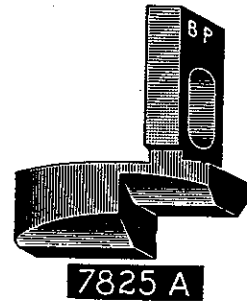
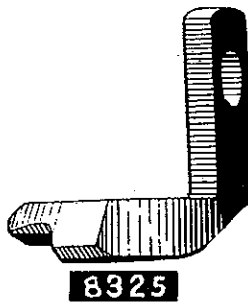
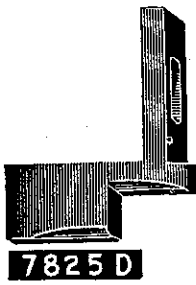
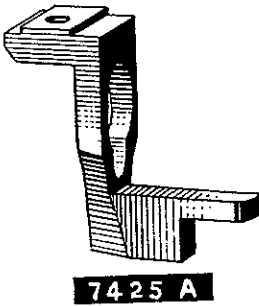
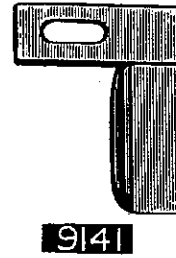
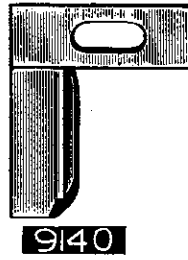
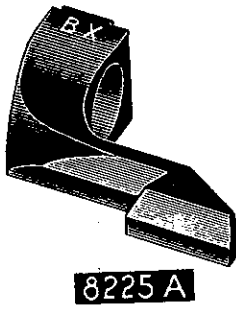
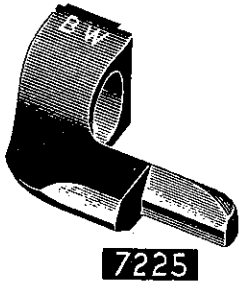

Specify Gauge



Specify Gauge

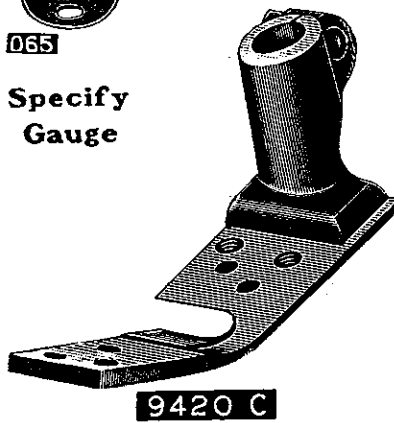
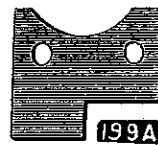

Specify Gauge

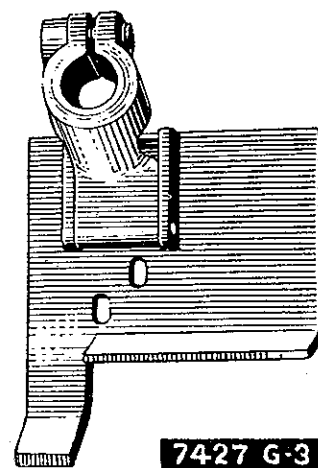

Plate 11—Full Size

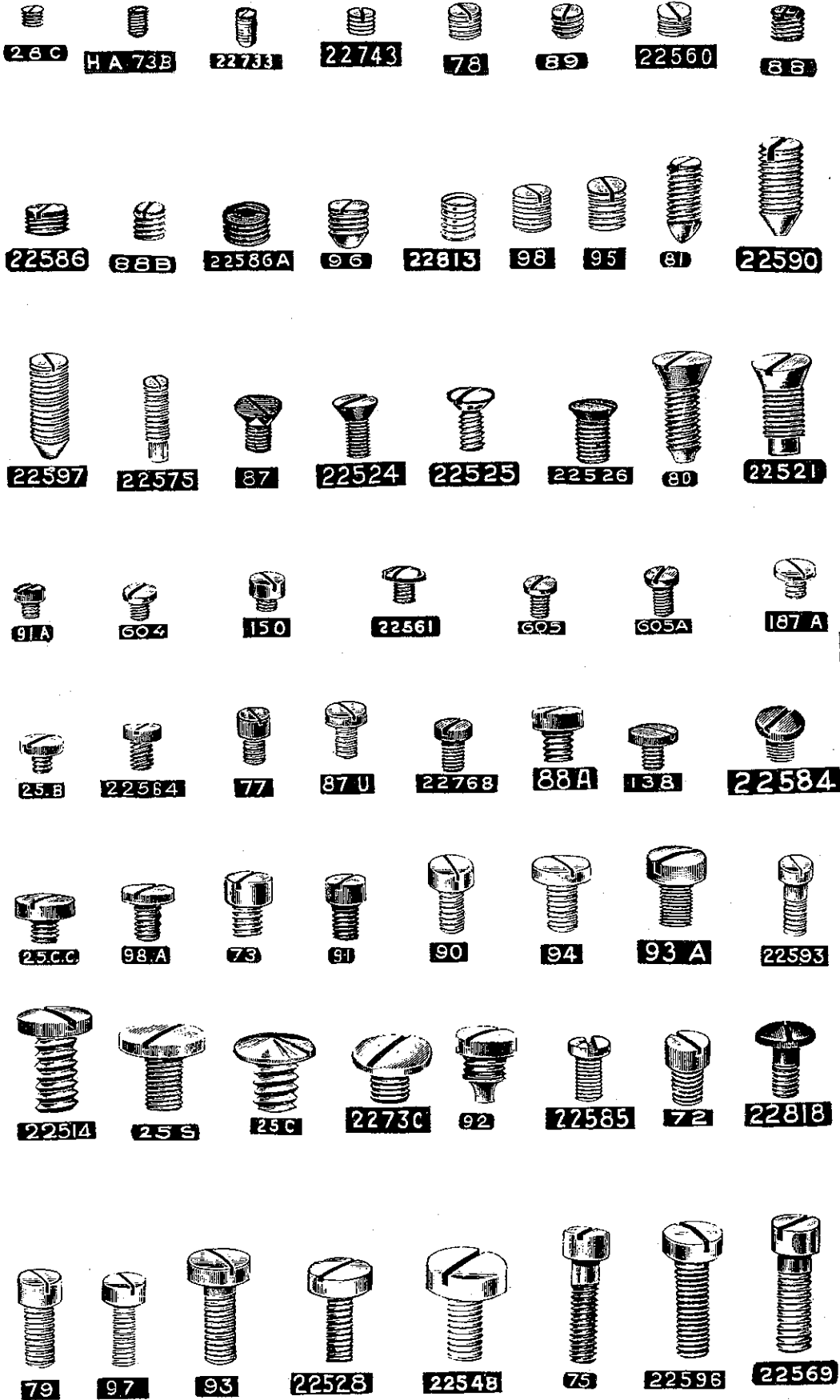

Plate 12—Full Size

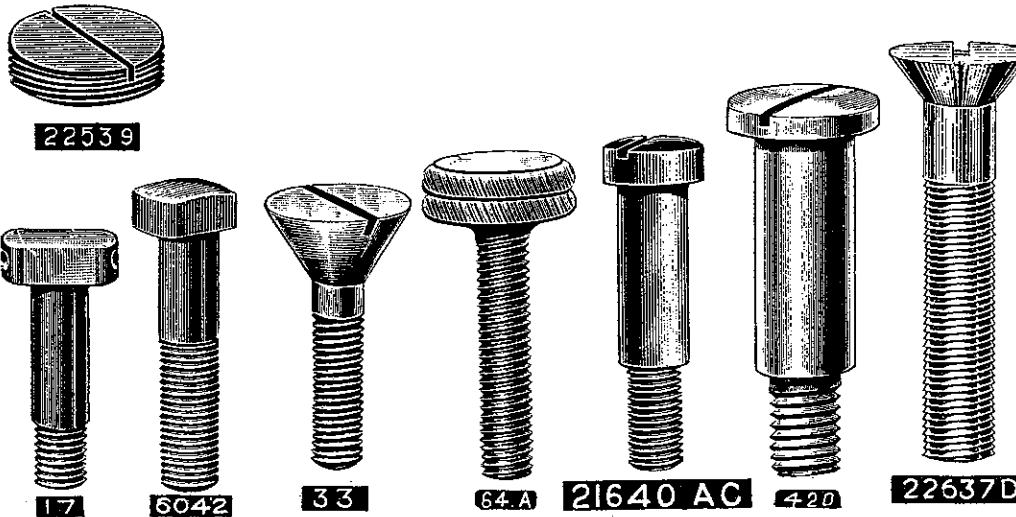
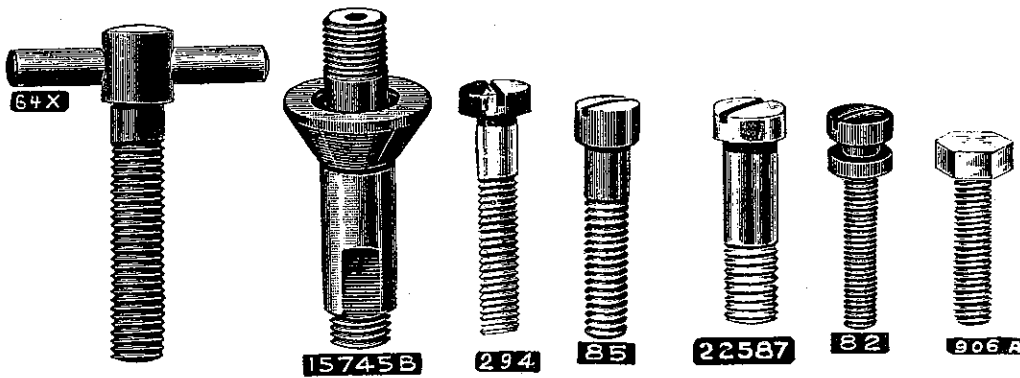
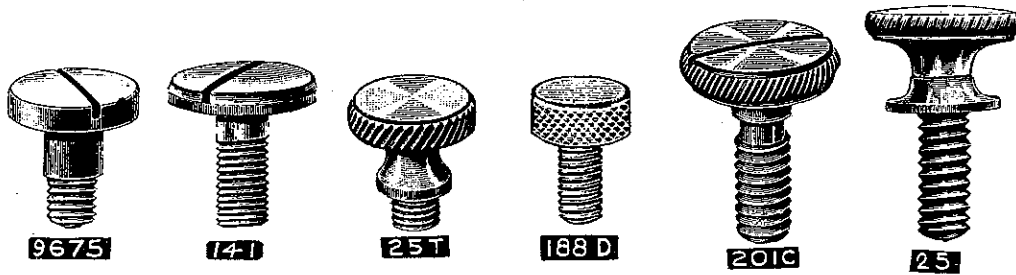
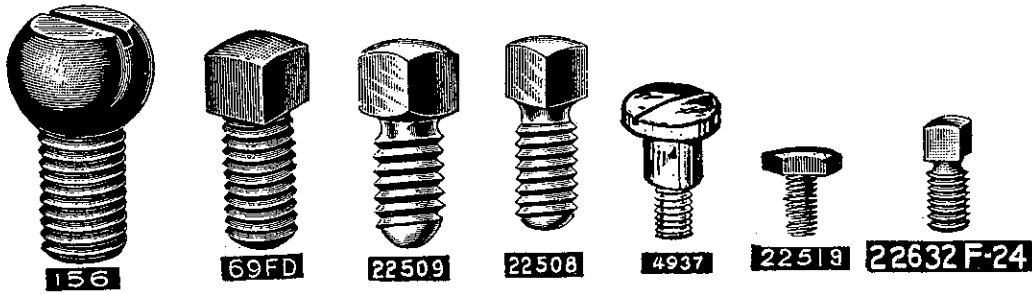
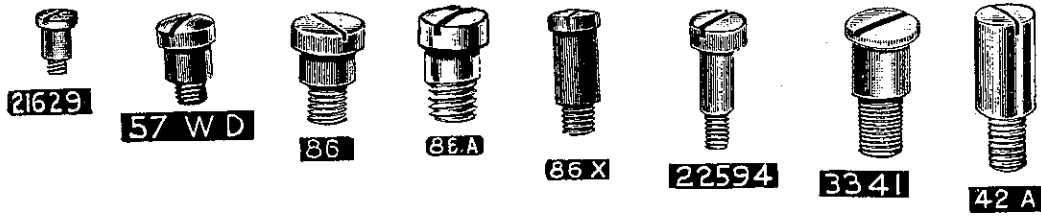

Plate 13—Full Size

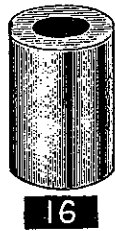
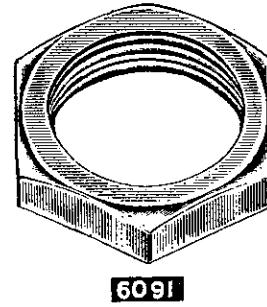
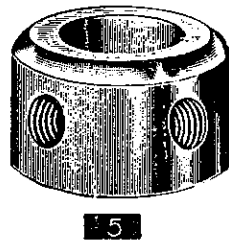
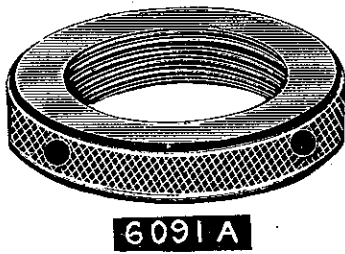
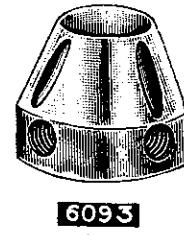
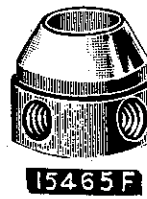
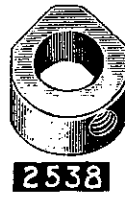
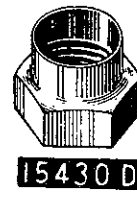
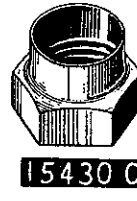
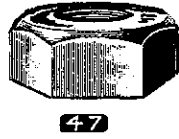

Plate 14—Full Size

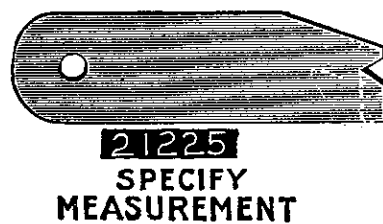
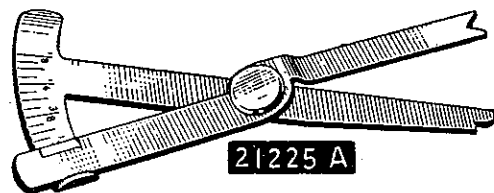
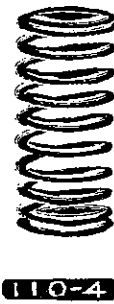
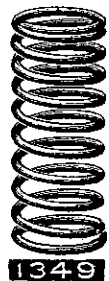
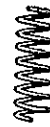
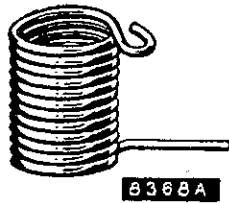
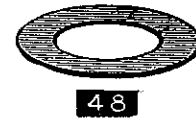
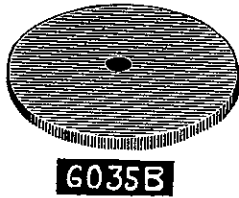
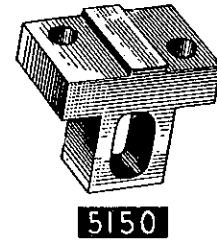
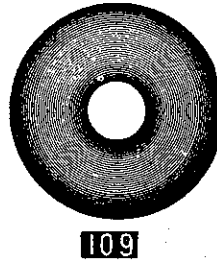
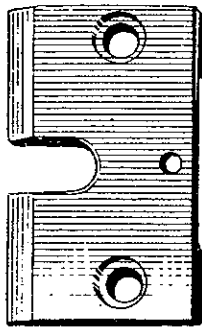
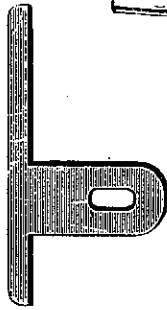

Plate 15—Full Size



3338 A



3344

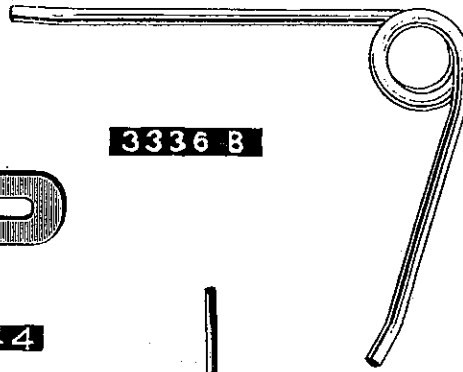

3336 B

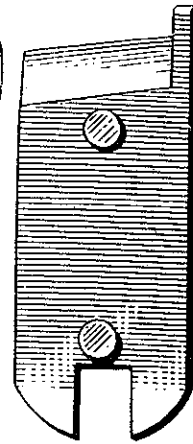

3335 A

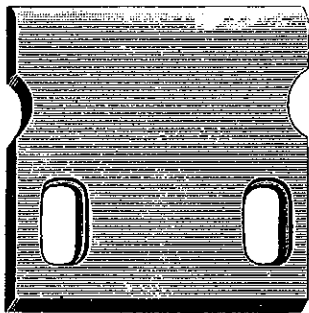

3339



3343



3342



3340

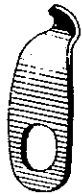

3336 C



3345 A

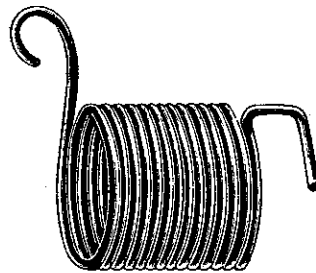

3346 A

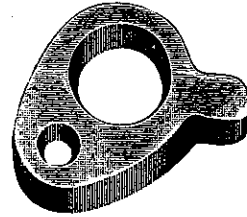

3348

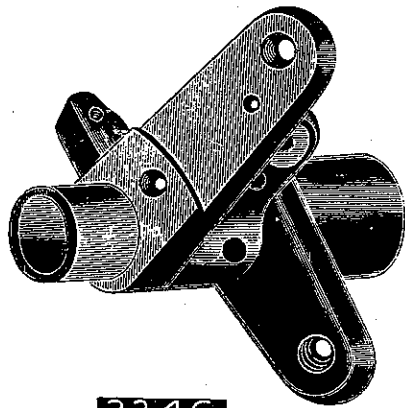

3346

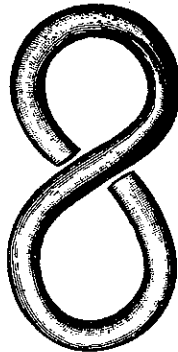

3349

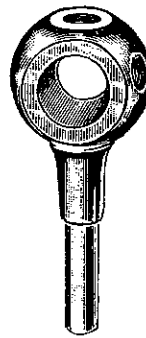

61 C

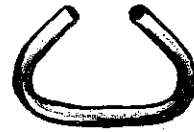

21351



21350

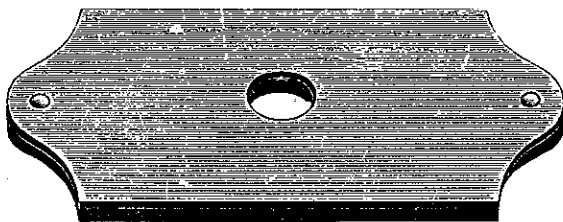

1007

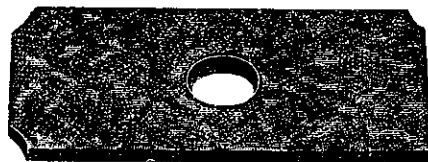

1008

Plate 16—Full Size

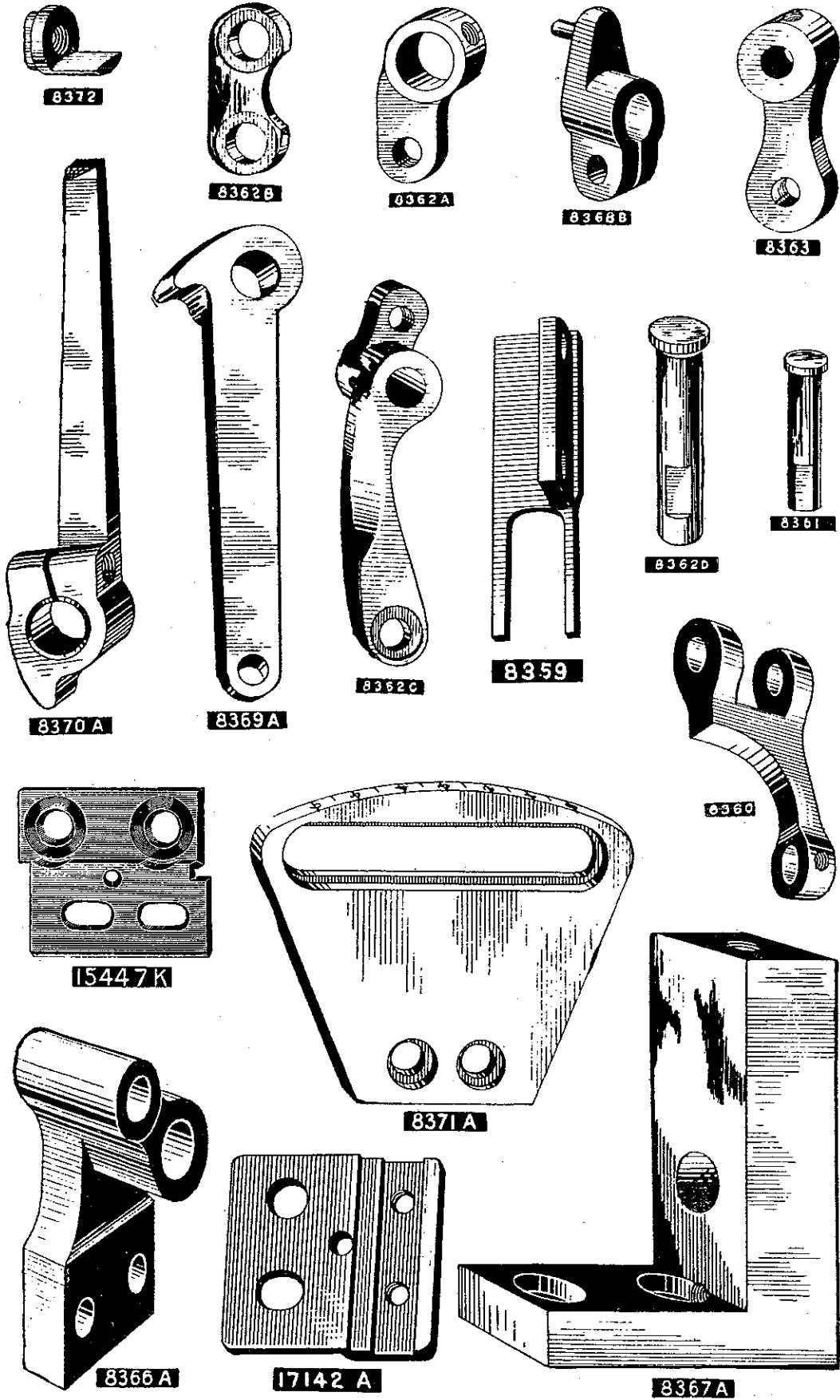
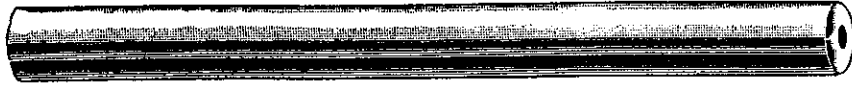

Plate 17—Full Size



14544



6092

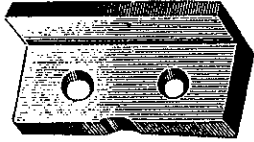

15447 L

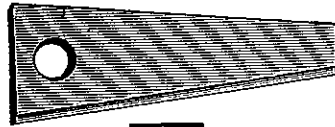

104



8562

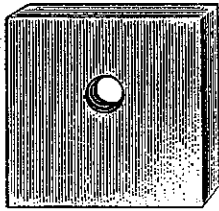

6 B



154

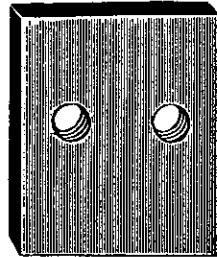

15447 F



8563



430 B



50J-40



430 A



426 A



5636



4-30



1362



VII 8



VII 9



VII 3

Plate 18—Full Size

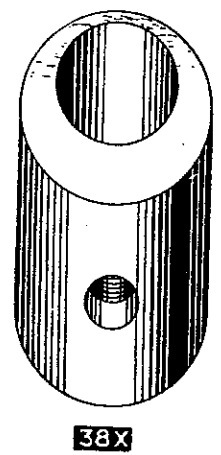
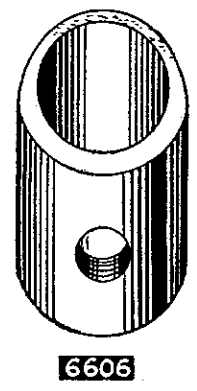
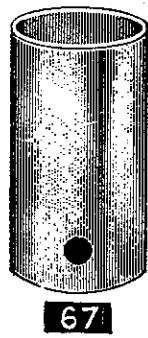
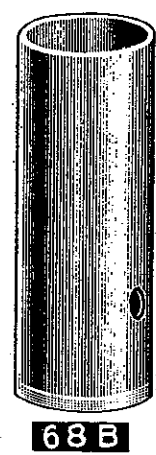
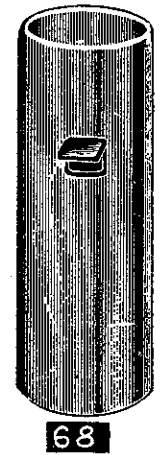
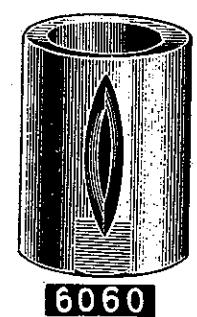
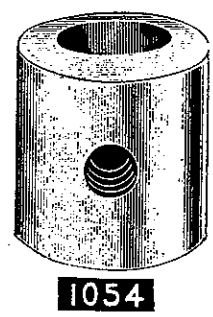
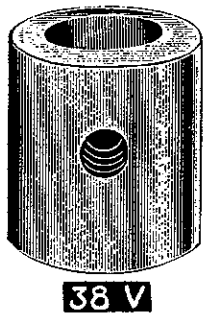
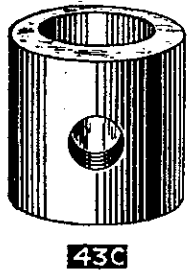
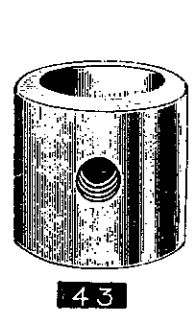
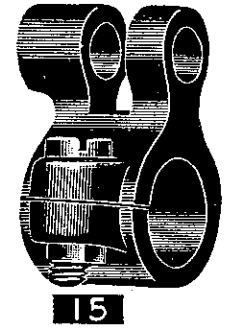
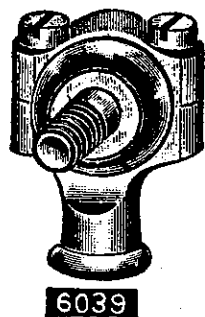
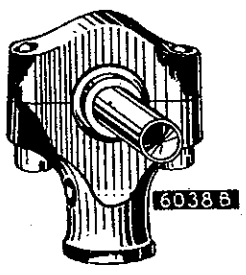
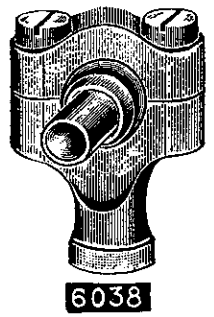
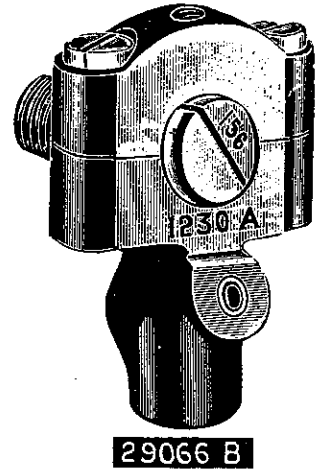
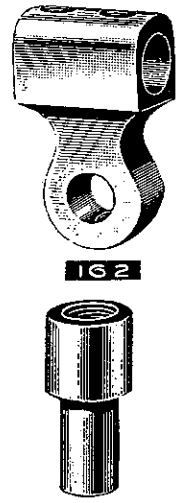

Plate 19—Full Size



35582 B



7448 A

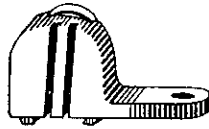

21610 A

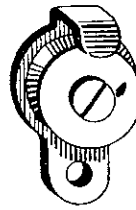

21624

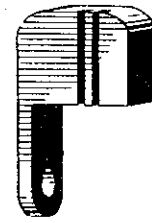

21632

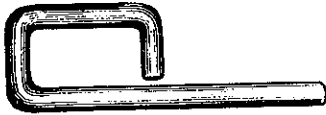

143 B

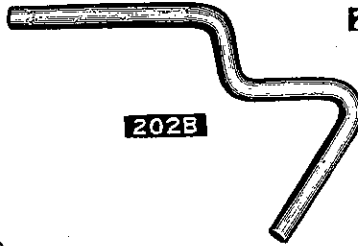

202 B



56 B-2

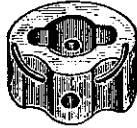

56 B-4

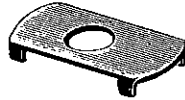

57-W.B



21628

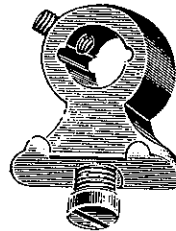

1287



7918-48



7018 E

Specify Gauge



8318

Specify Gauge



7040-33



7933-48



7040-6



1288



202 A



11262

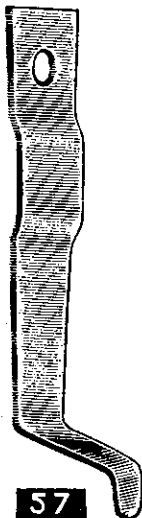

57



58

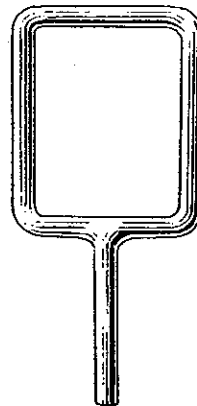

15151

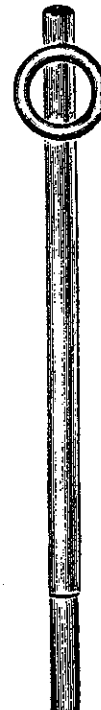

40

Plate 20—Full Size

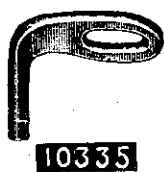

10335



158B



10334A



158



52-A



137

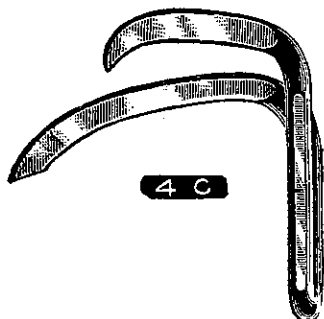

4 C

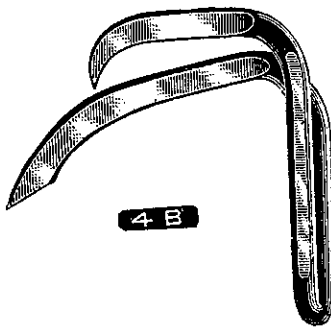

4 B

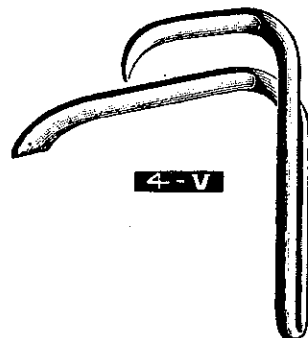

4-V

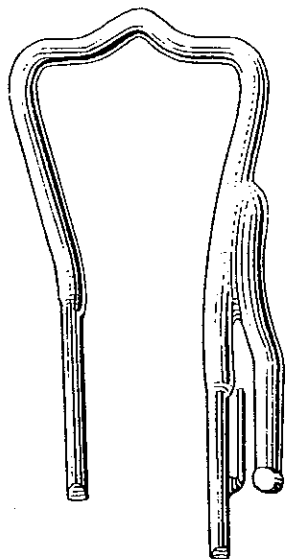

7656

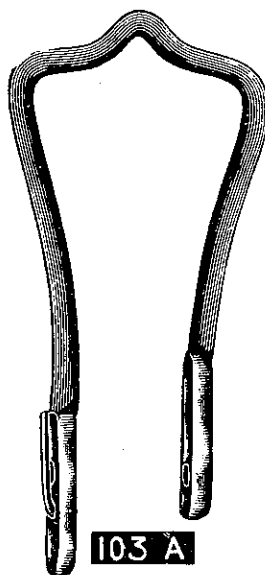

103 A

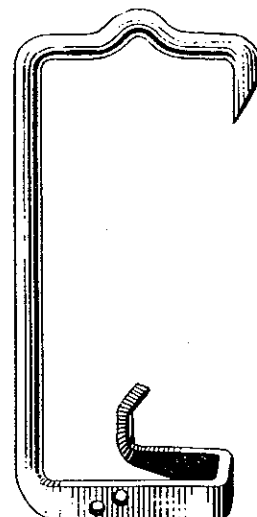

7458 A

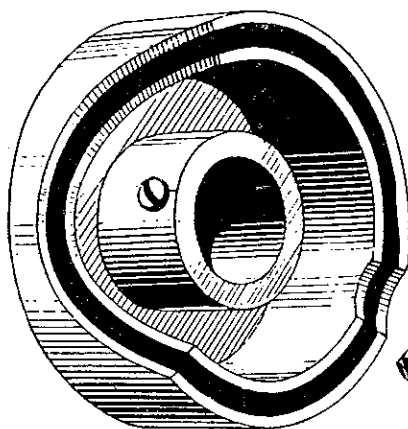

7423 A

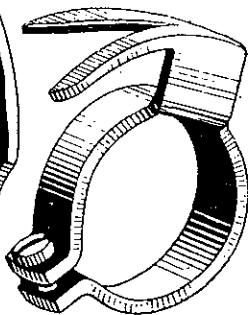

7404 A

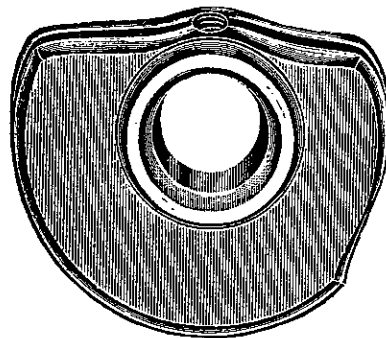

101 V

Plate 21—One-half Size

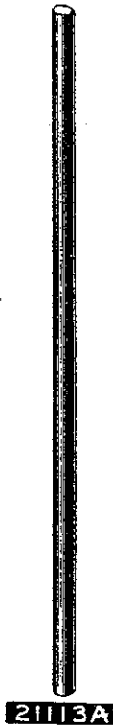
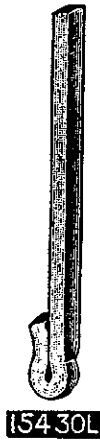
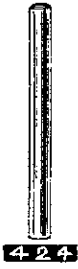
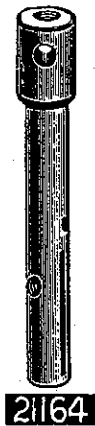
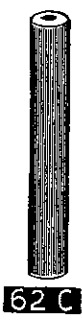

Plate 22—One-half Size

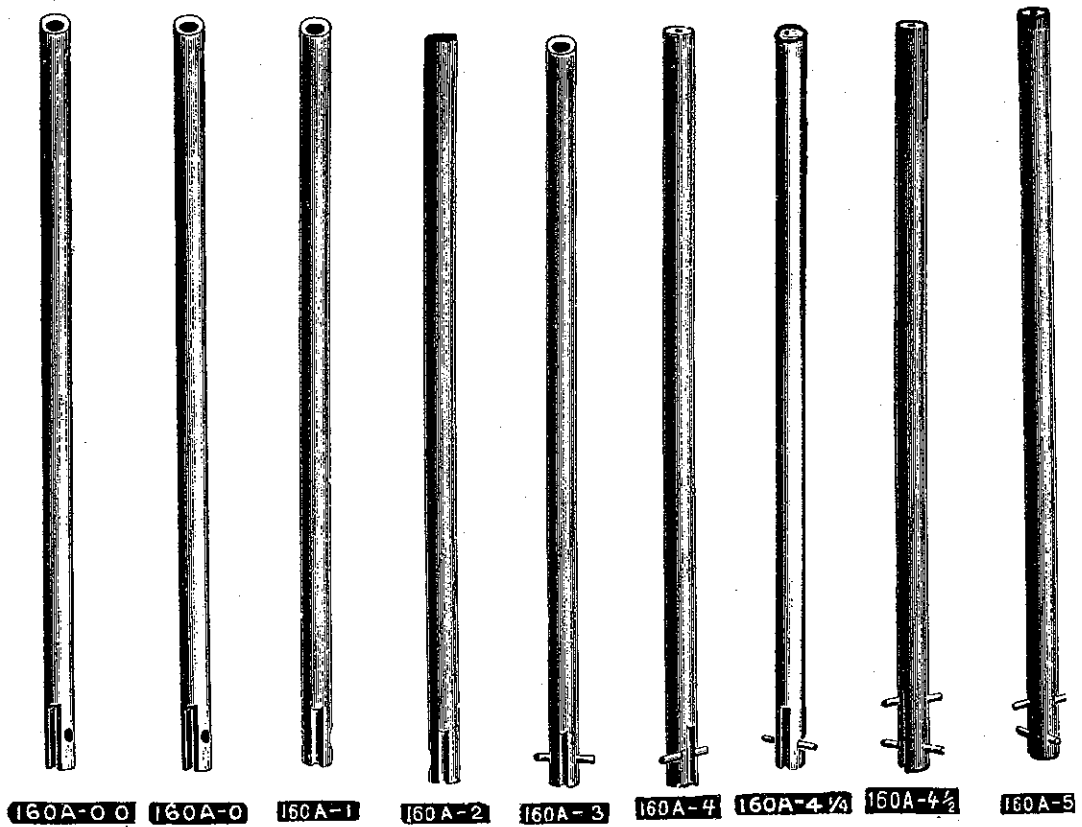
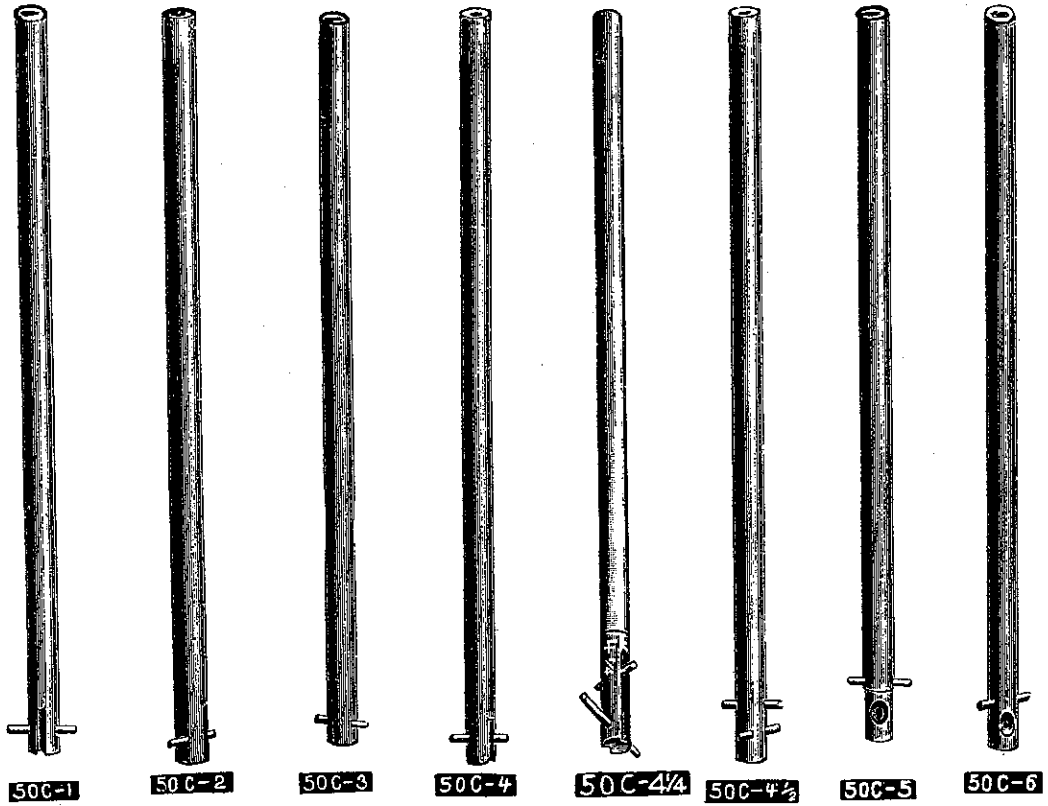

Plate 23—One-half Size

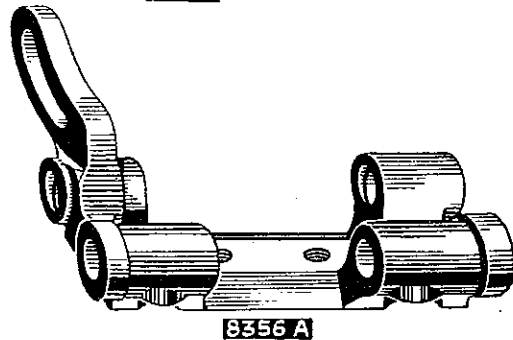
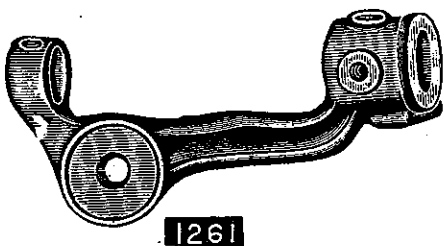
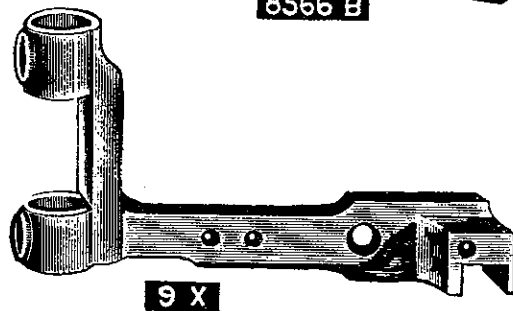
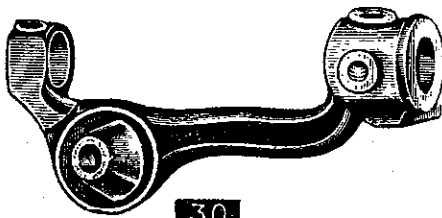
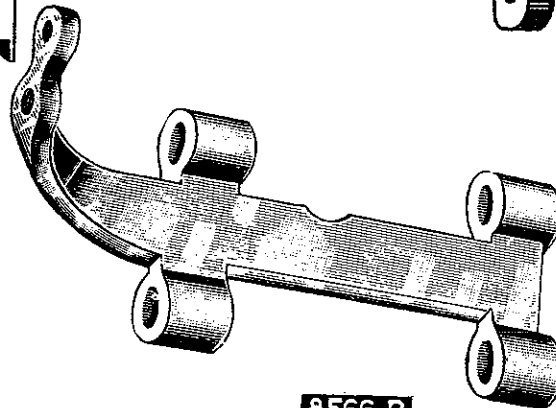
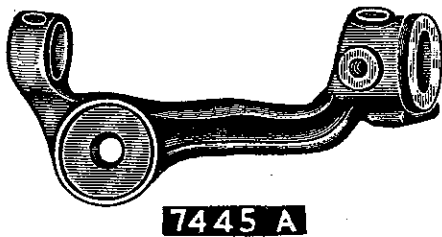
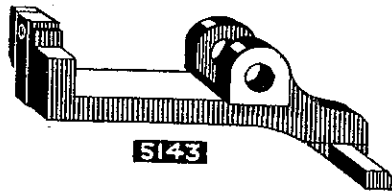
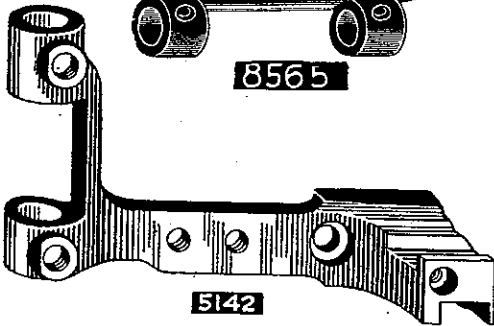
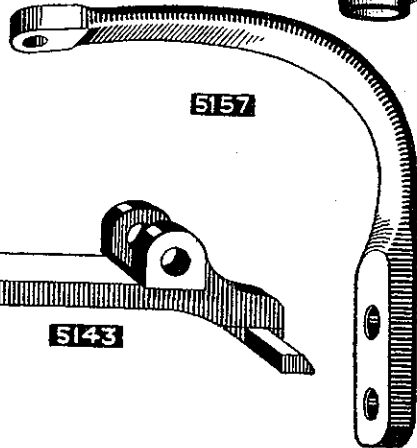
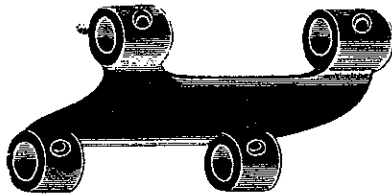
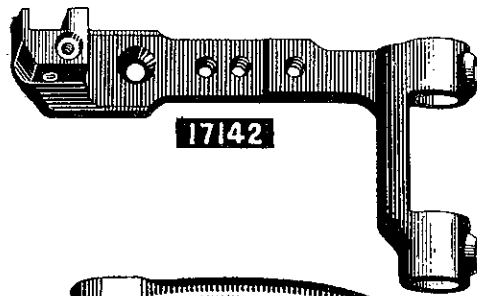
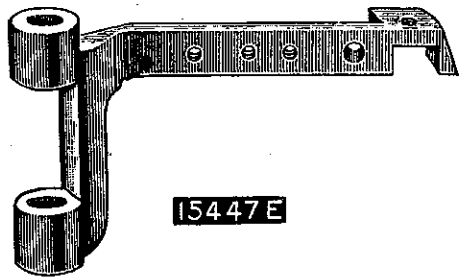
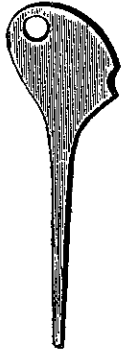

Plate 24—One-half Size



194



21601



21603



21602



21607



21605

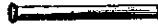

21606

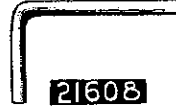

21608



21364

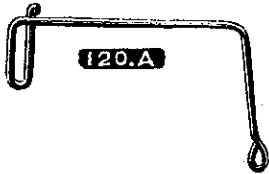

120.A

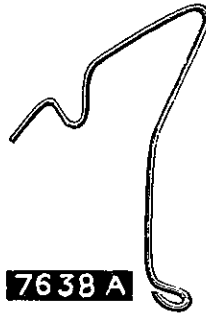

7638 A



8561



282



9271



164-1

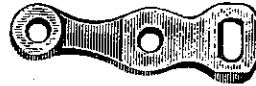

7 F

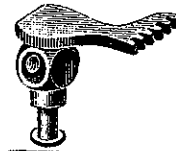

142C

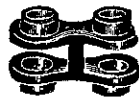

54

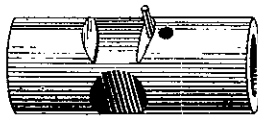

7463 A

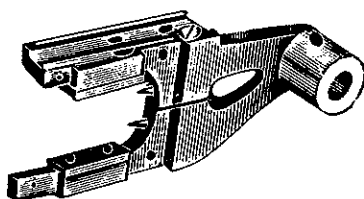

8560

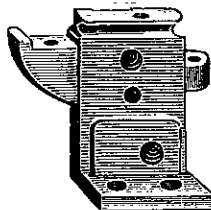

102



21640AB



139A

Plate 25—One-half Size

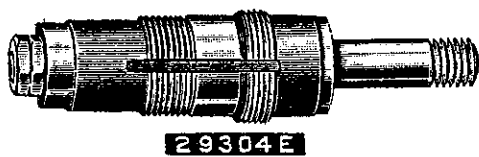
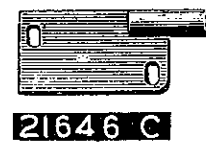
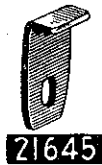
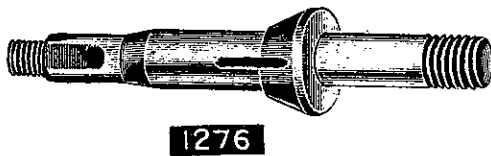
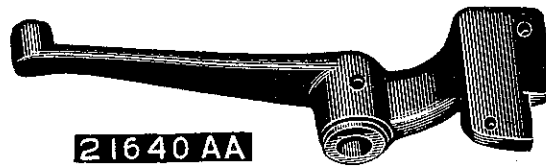
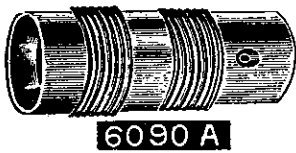
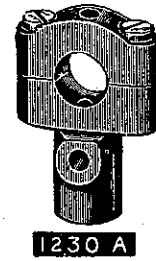
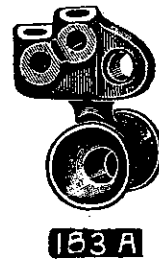
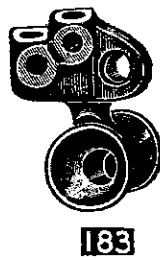
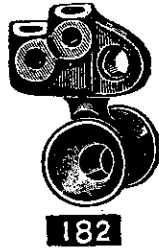
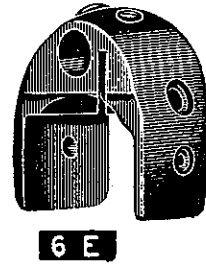
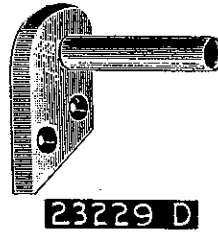
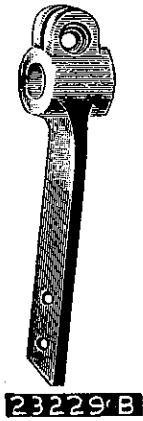
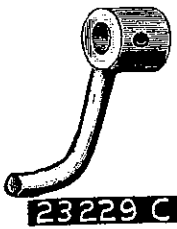
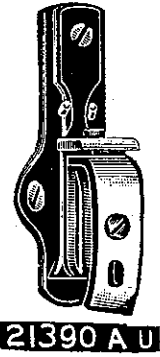
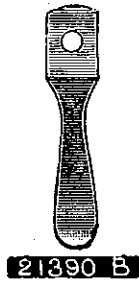
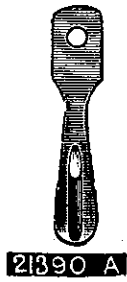
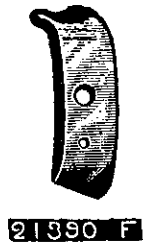
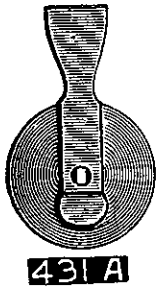

Plate 26—One-half Size

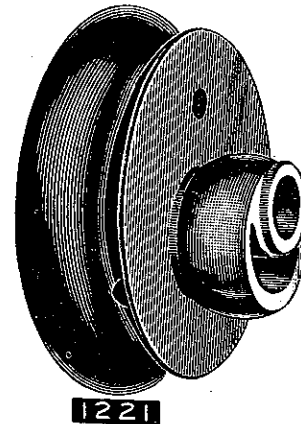
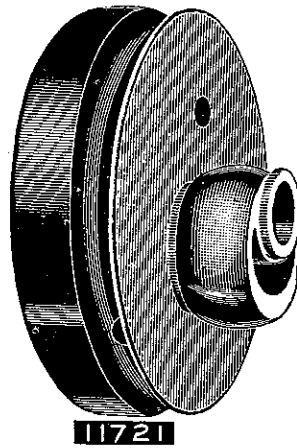
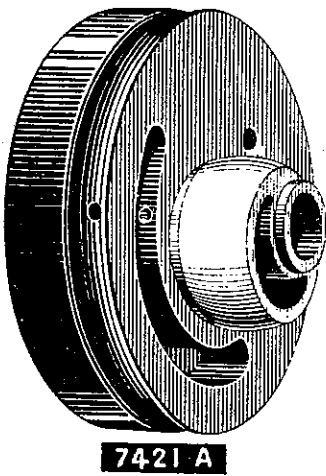
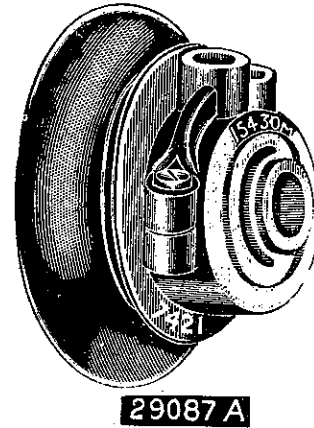
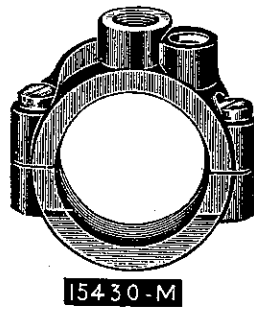
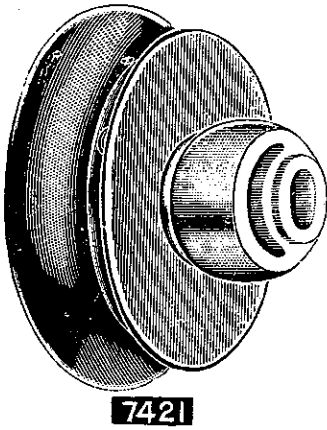
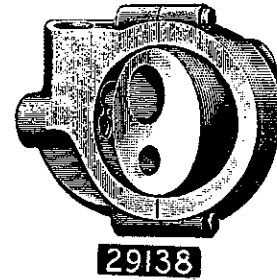
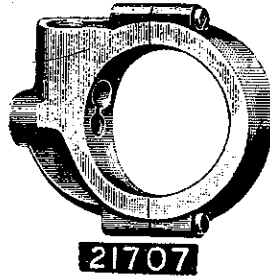
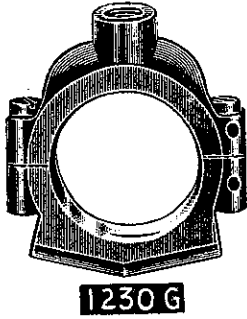
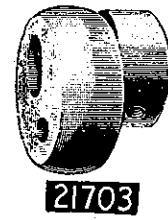
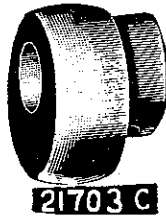
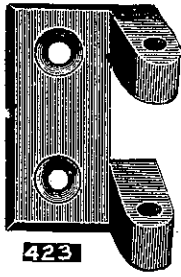
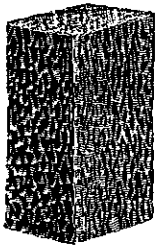

Plate 27—One-half Size



1004



1005



8932

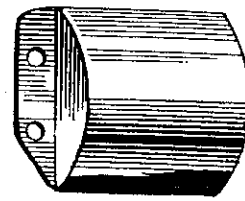

8374



70



8567

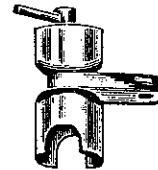

21603



660-62



10

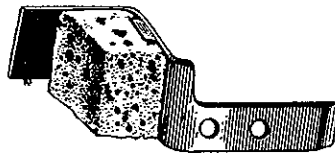

15447 G

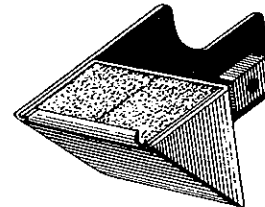

21396 AC

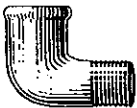

11684 AA



21396

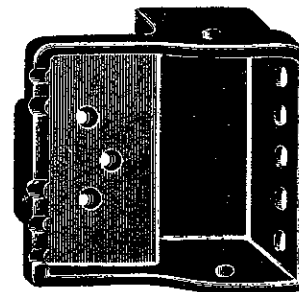

1002

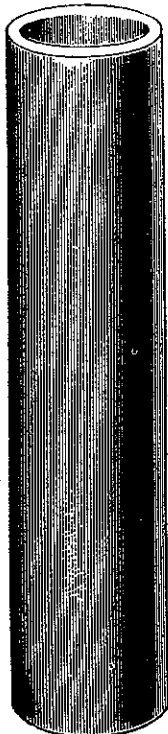

21355 A



21355

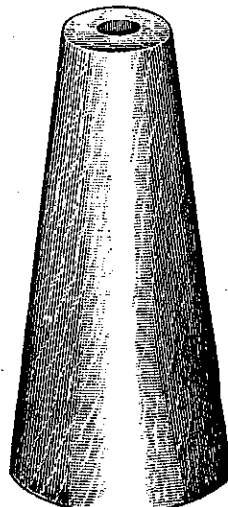

21145

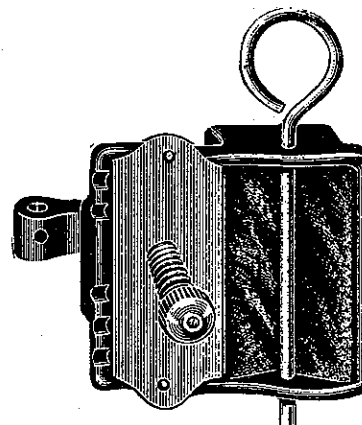

1000

Plate 28—One-half Size

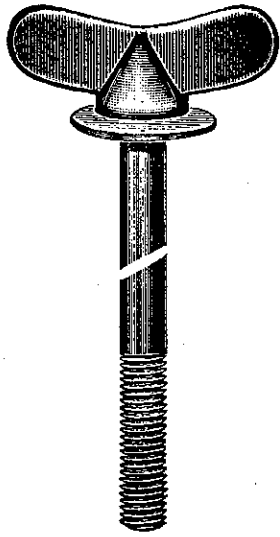

105
SPECIFY
MEASUREMENT

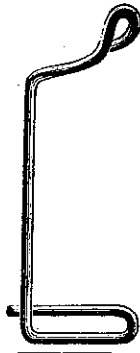

21170

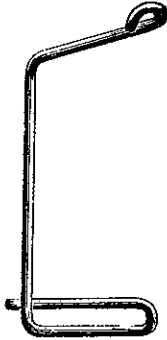

21170 A

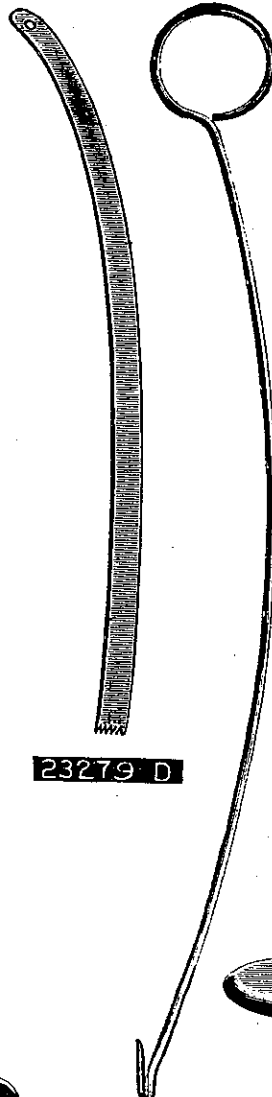

23279 D

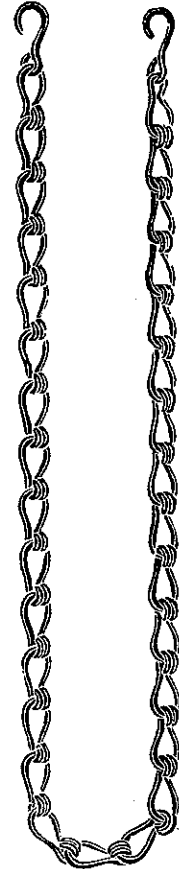

421

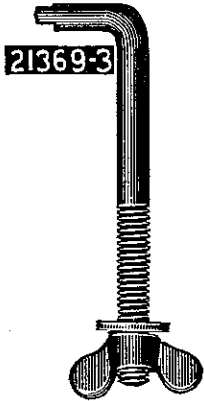

21369-3

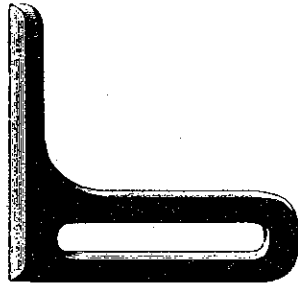

24

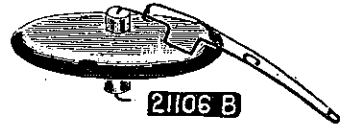

21106 B

118



21207



116



21388



21388 N

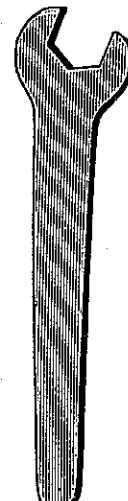

21388 B



118 B

Plate 29—One-half Size

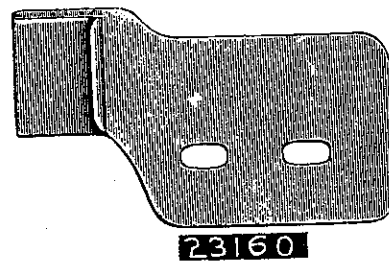
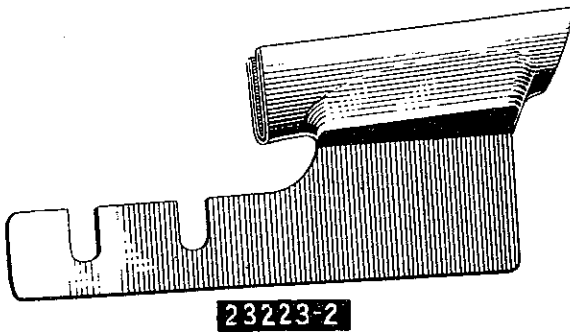
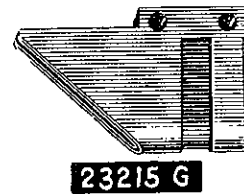
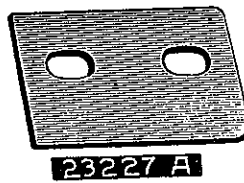
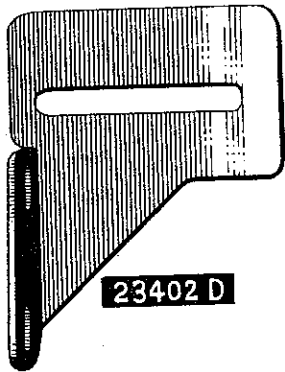
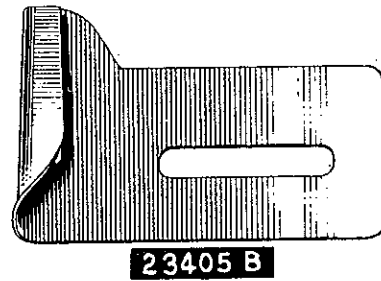
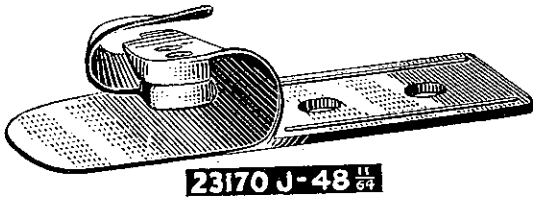
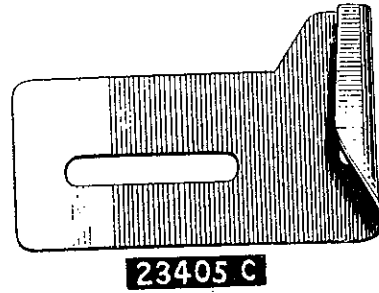
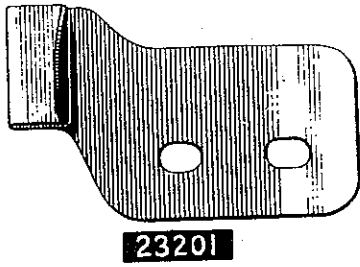
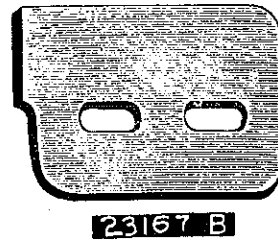
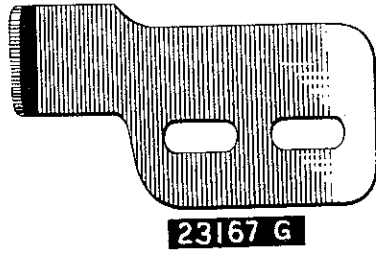
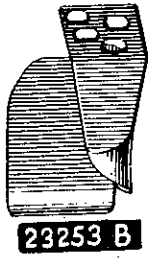
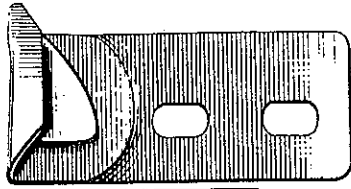
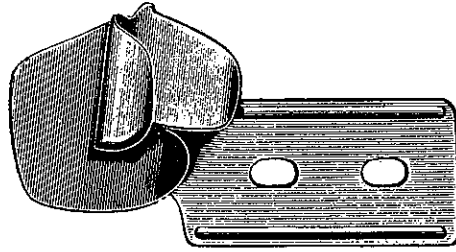

Plate 30—One-half Size



23253 F



23204

Specify Gauge and Capacity

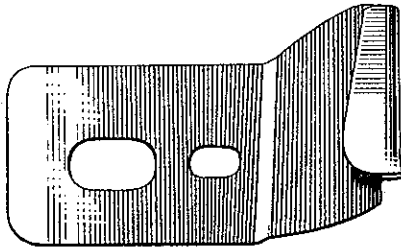

23297 D

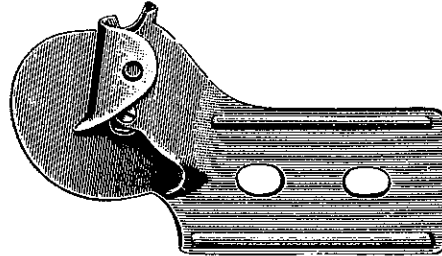

23170

Specify Capacity

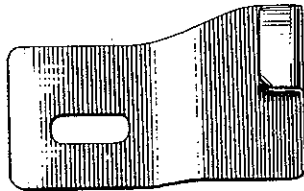

23404

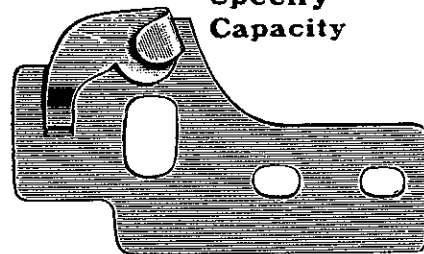

606 A

Specify Gauge

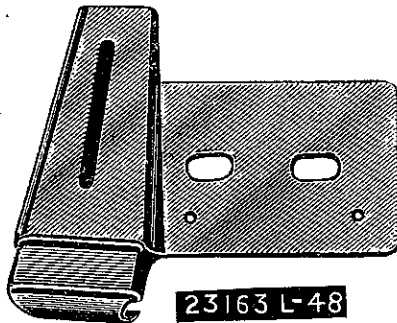

23163 L-48

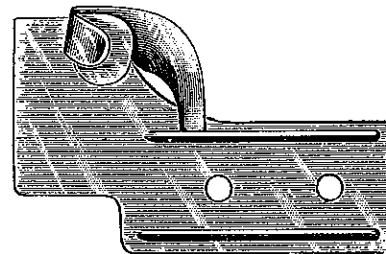

606

Specify Gauge

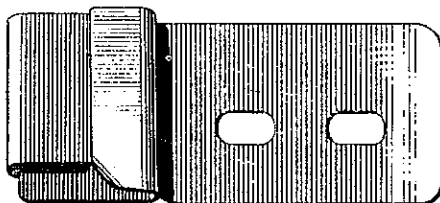

23184 H

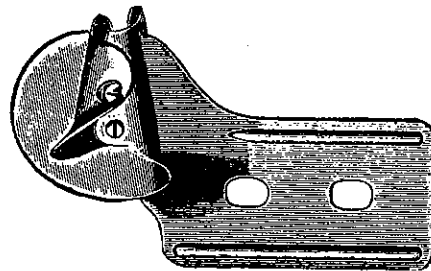

600

Specify Gauge and Capacity

Plate 31—One-half Size

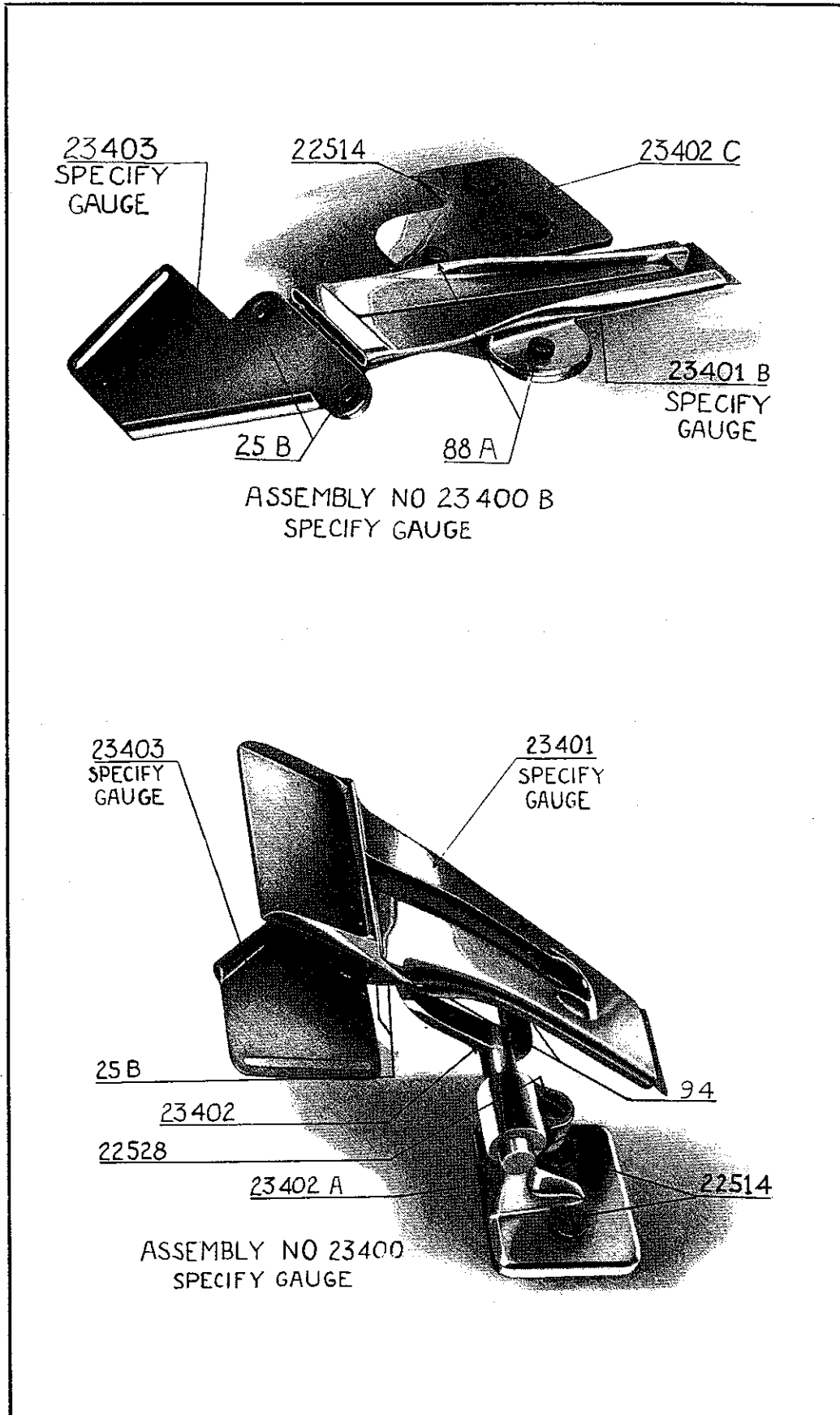
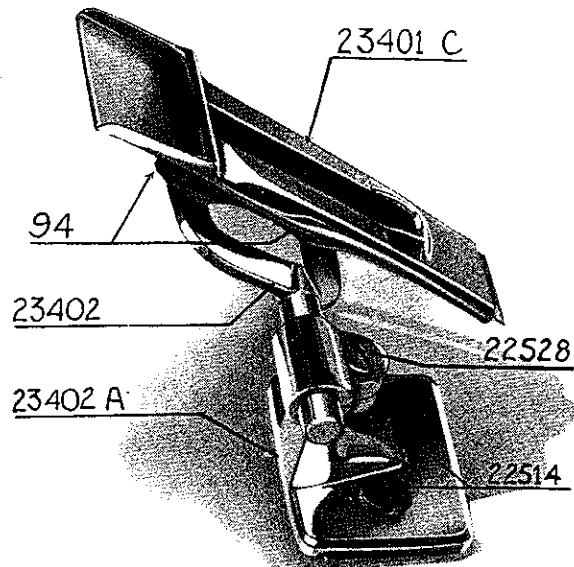
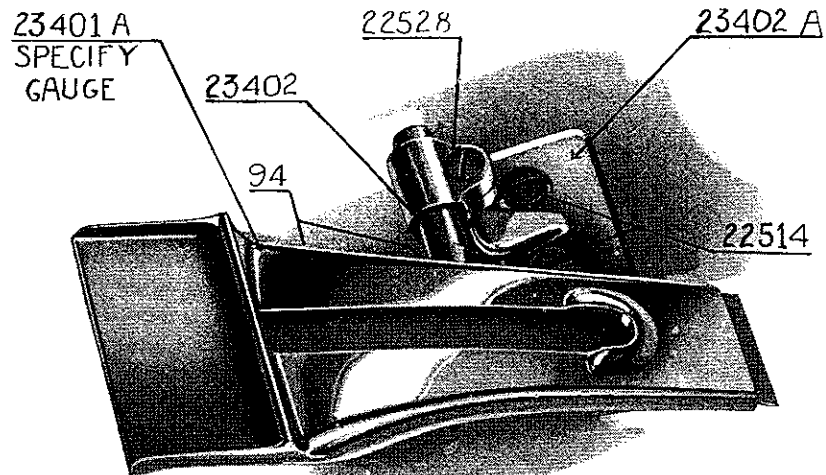

Plate 32—One-half Size



ASSEMBLY NO 23400 C
SPECIFY GAUGE



ASSEMBLY NO 23400 A
SPECIFY GAUGE

Plate 33—One-half Size

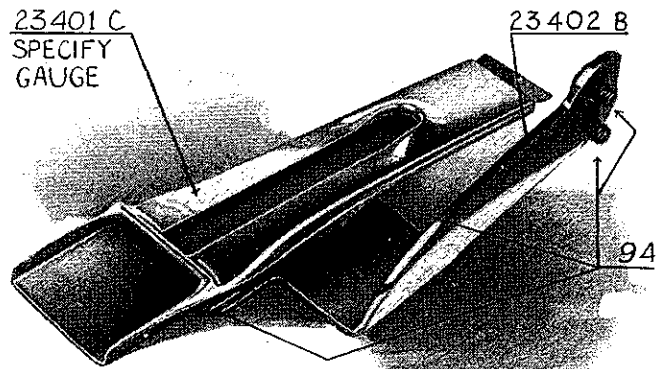

ASSEMBLY NO 23400 Q
SPECIFY GAUGE

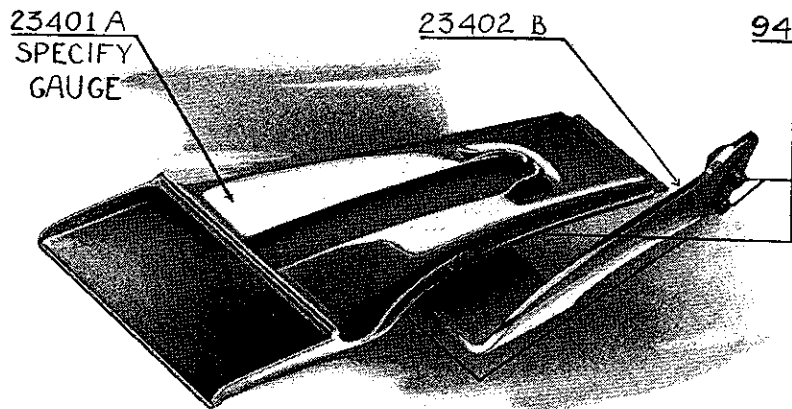

ASSEMBLY NO 23400 P
SPECIFY GAUGE

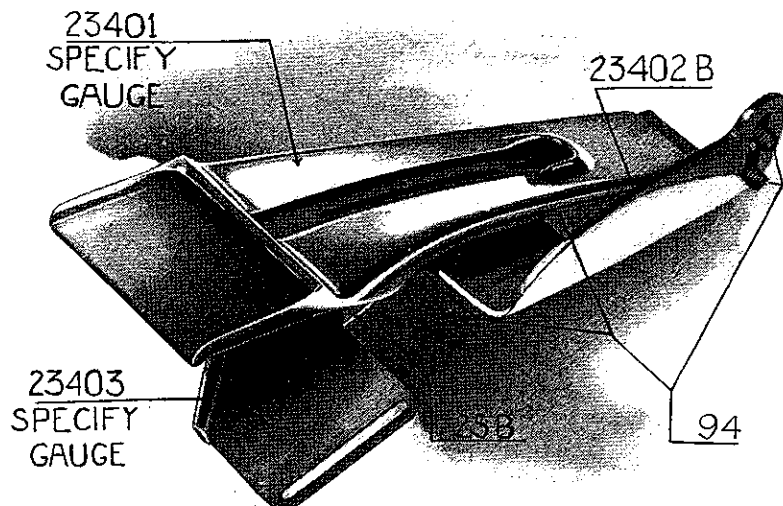

ASSEMBLY NO 23400 N
SPECIFY GAUGE

Plate 34—One-half Size

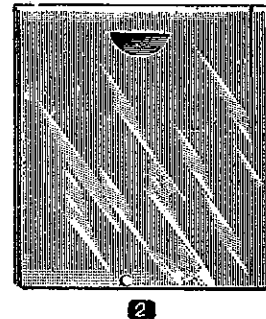
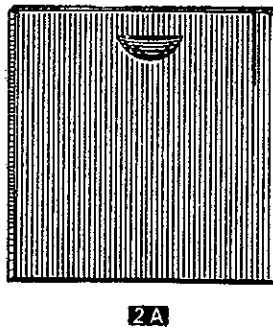
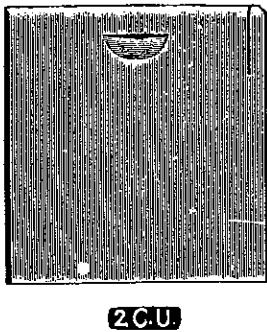
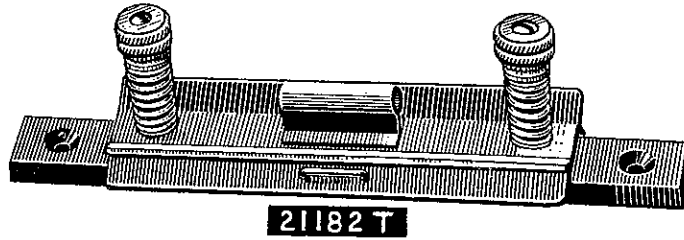
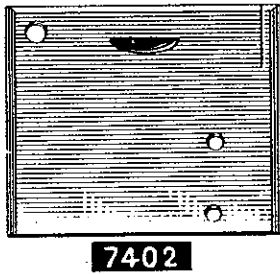
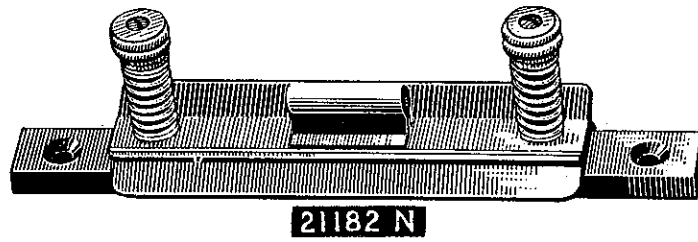
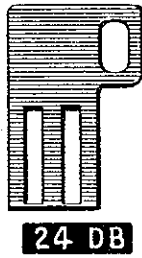
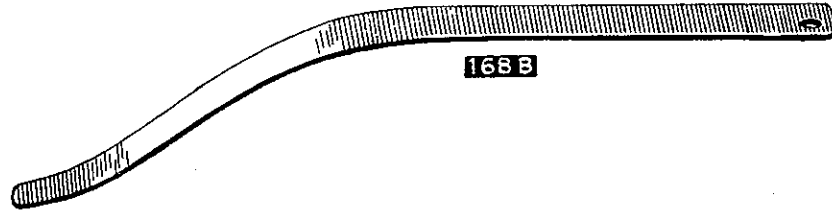
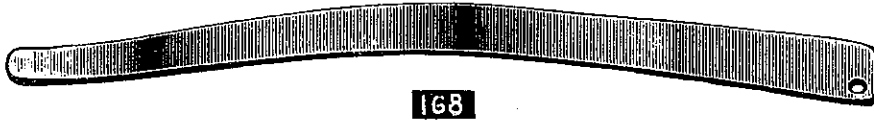
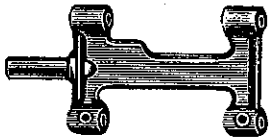

Plate 35—One-fourth Size



7 G



7499 A



416 A



8647

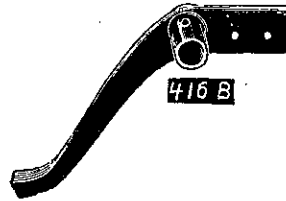

416 B



7462 D



7484 A



7 H



8646

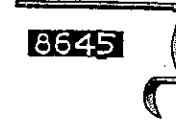

8645

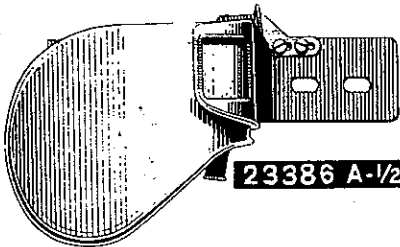

23386 A-1/2

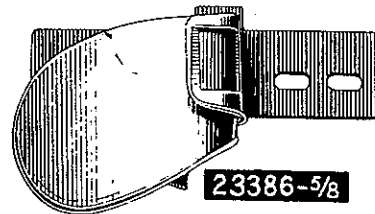

23386-5/8

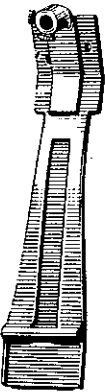

7427 T-48

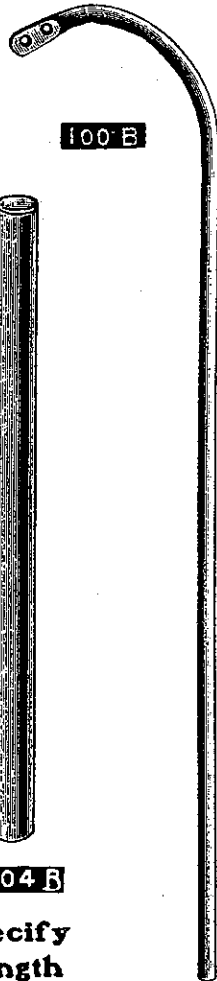

100 B



7422 A

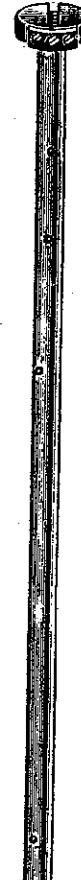

169



7822

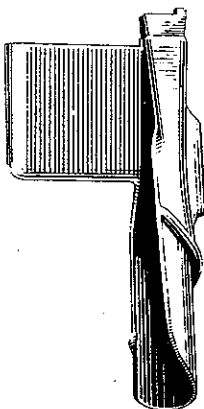

23406 B-7/8

21104 B

Specify Length

Plate 36—One-fourth Size

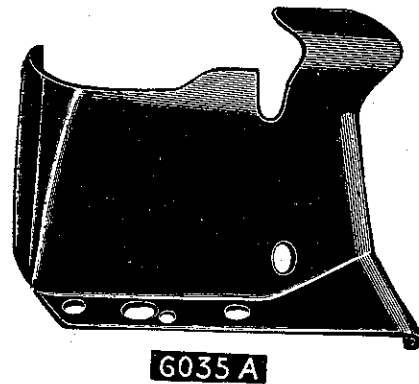
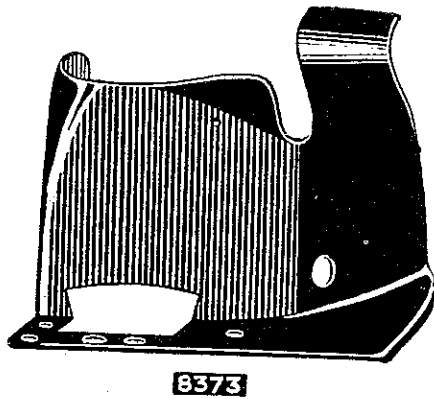
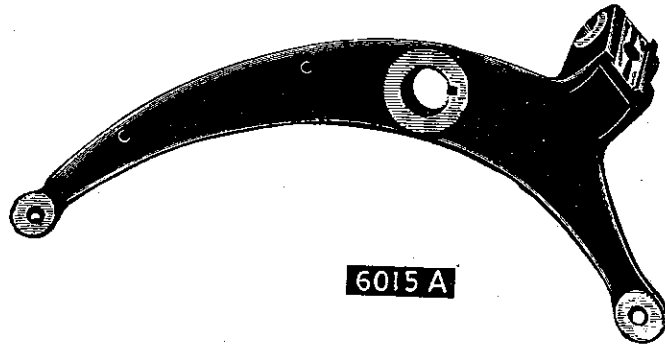
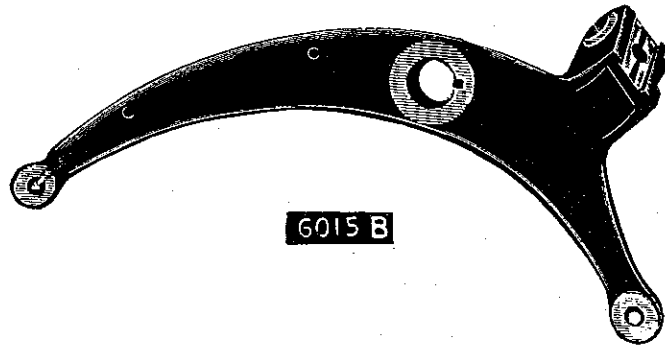
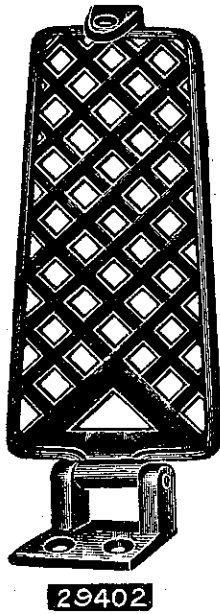
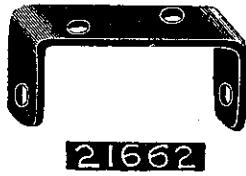
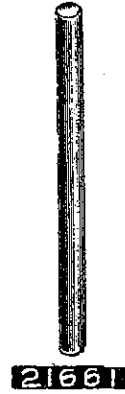
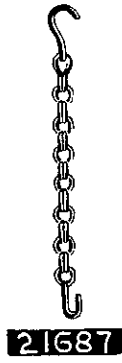
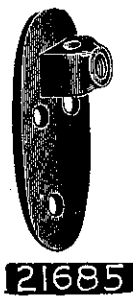
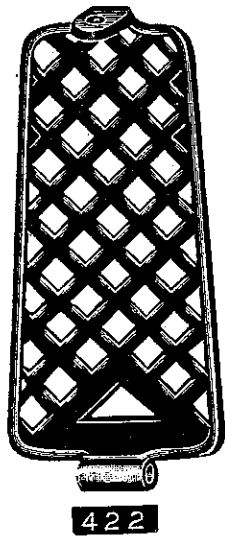

Plate 37—One-fourth Size

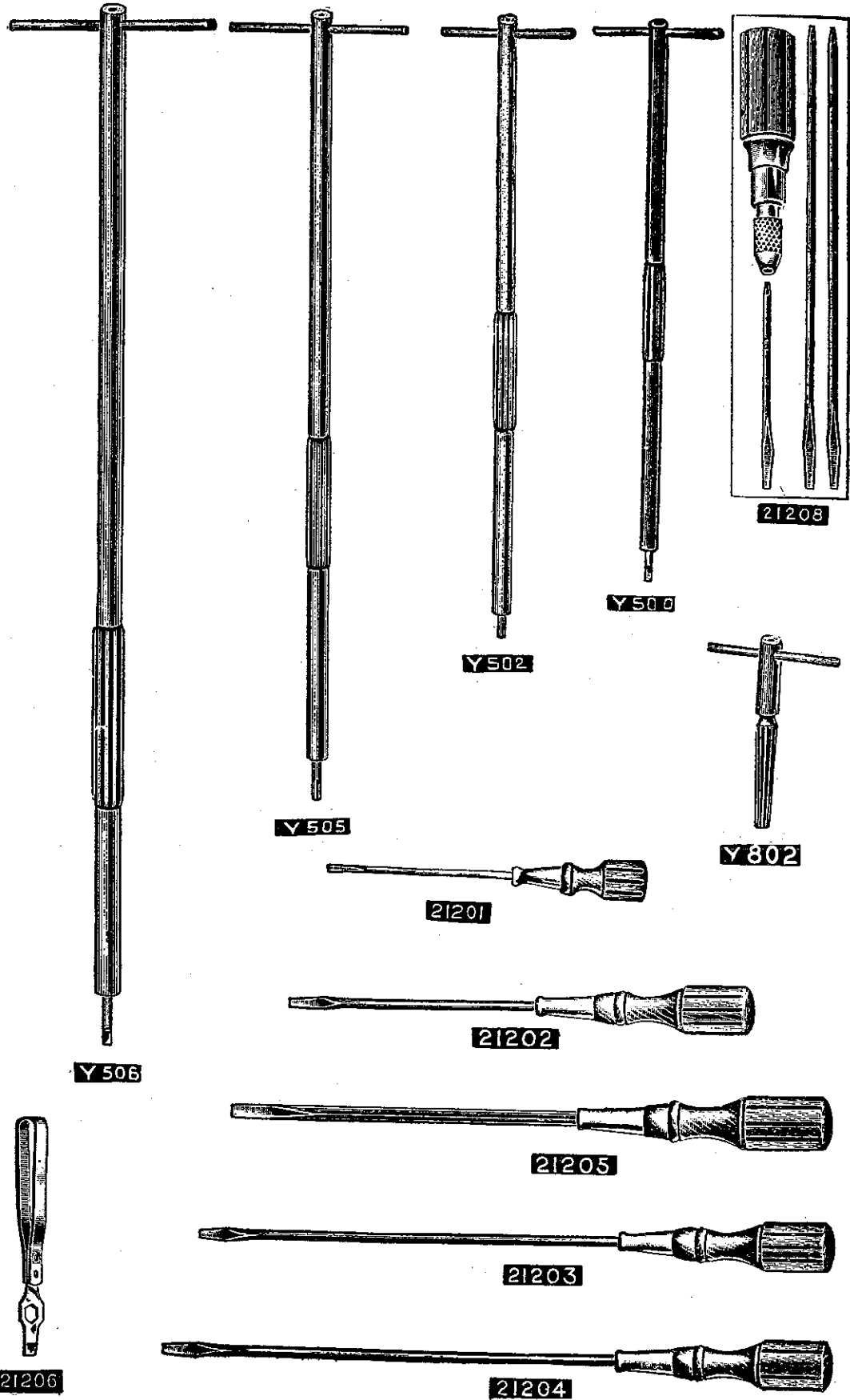

Plate 38—One-eighth Size

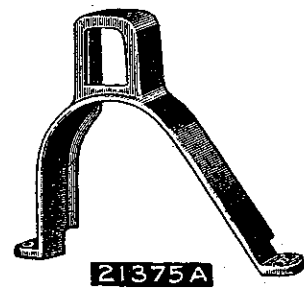
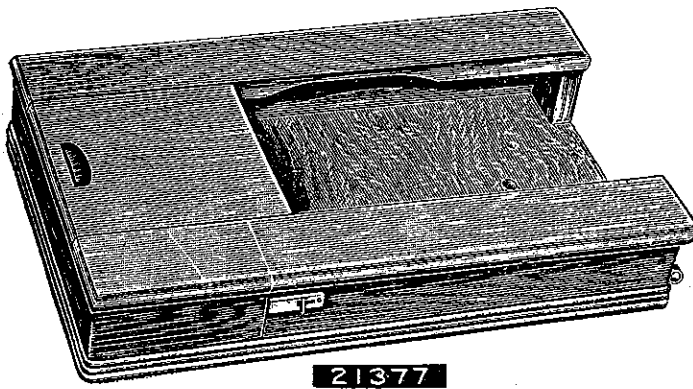
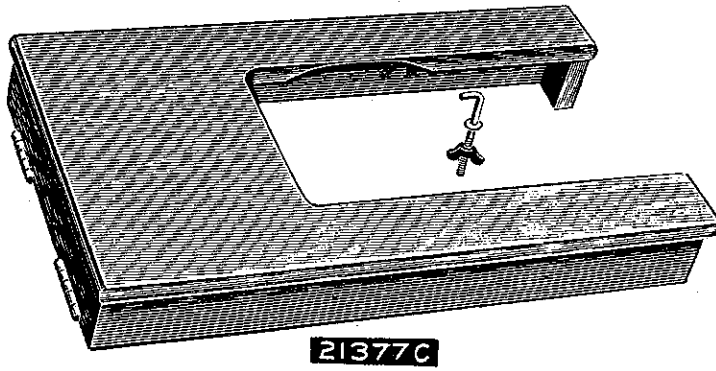
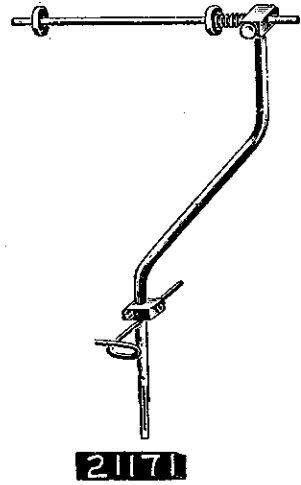
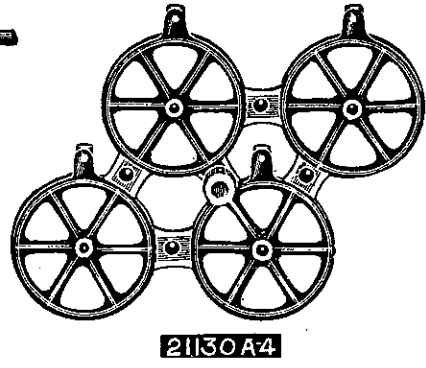
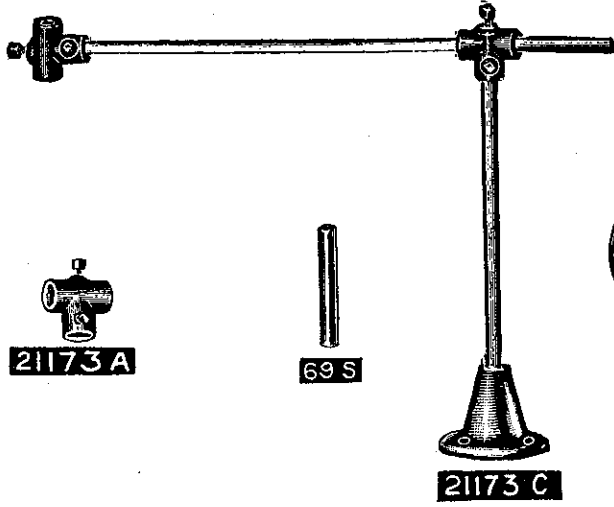

Plate 39—One-eighth Size



21168 G



21161 D



21385 B

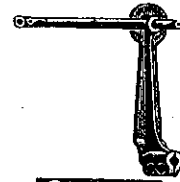

21161 C



119

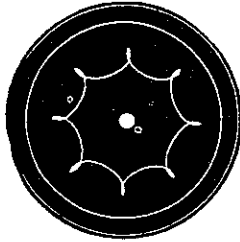

21178

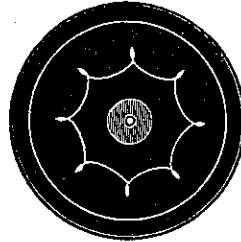

21157



201A

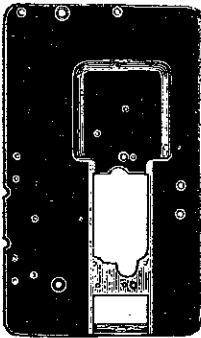

8501

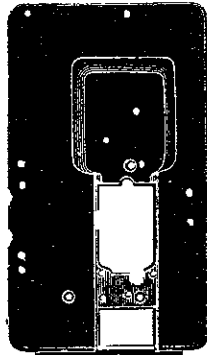

7401A

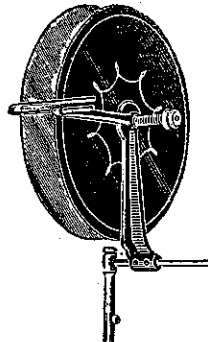

21150

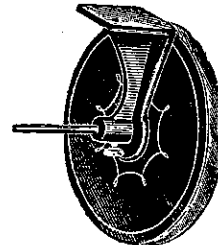

21176 A

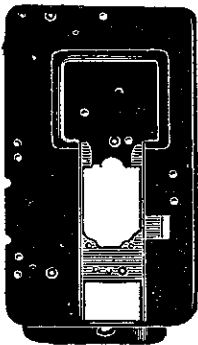

7401R

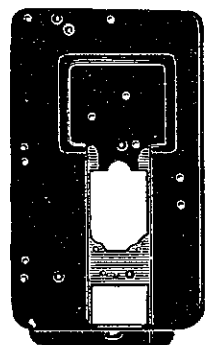

7801



8301M

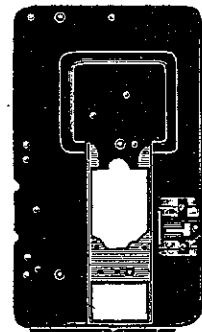

7201 T

LIST OF PARTS

Symbol to Order by	The figures in the last column refer only to the plates illustrating the parts and are not to be used in ordering.	Plate No.
2	Cloth Plate Slide, right, $2\frac{9}{16}$ inches long, for styles in Classes 7000, 7200, 7400, 8200, 8300; also Styles 7500 B, 7500 X, (stop screw No. 150)	34
2 A	Cloth Plate Slide, left	34
2 CU	Cloth Plate Slide, right, $2\frac{5}{8}$ inches long, for styles in Classes 7000, 7400, 7800, (stop screw No. 150)	34
4 B	Cast-off Wire, for styles in Class 7800, having double disc take-up	20
4 C	Cast-off Wire, for styles having double disc take-up in Class 7500; also Style 7400 AG	20
4 V	Cast-off Wire, for styles having double disc take-up in Classes 7000, 7200, 8200, 8300; also Styles 7400 A, 7400 B, 7400 N, 7400 U, 7400 V, 7400 W, 7400 X, 7400 Y, 7400 AA, 7400 AF, 7400 AH, 7400 AJ, 7400 AK, 7400 AM, 7400 AN, (screw No. 22524)	20
5	Main Shaft Collar, (screws No. 95)	13
6 B	Looper Eccentric Fork Shoe, hardened and ground, (screw No. 94)	17
6 E	Looper Eccentric Fork, (clamp screw No. 85, set screws No. 72)	25
7 F	Feed Rocker Arm, for use with feed rocker No. 8566 B, (screws No. 22548)	24
7 G	Feed Rocker, floating design, for styles in Classes 7000, 7200, 7400, 7500, 7800, 8200, (screws No. 88)	35
7 H	Feed Rocker Arm, for styles having double disc take-up in Classes 7000, 7200, 7400, 7500, 7800, 8200, (clamp screws No. 93)	35
8	Feed Rocker Shaft, $5\frac{3}{16}$ inches long, hardened and ground, standard diameter .407 inch, for Style 8300 K	21
8-408	Feed Rocker Shaft, standard diameter plus .001 inch	—
8-410	Feed Rocker Shaft, standard diameter plus .003 inch	—
8-413	Feed Rocker Shaft, standard diameter plus .006 inch	—
8-416	Feed Rocker Shaft, standard diameter plus .009 inch	—
8-419	Feed Rocker Shaft, standard diameter plus .012 inch	—
8-422	Feed Rocker Shaft, standard diameter plus .015 inch	—
8 A	Feed Rocker Shaft, $5\frac{5}{8}$ inches long, for styles in Classes 7000, 7200, 7400, 7500, 7800, 8200	21
9 X	Feed Bar, for styles having double disc take-up in Classes 7000, 7200, 7400, 7500, 8200, (screws No. 88)	23
10	Feed Bar Prong and Sponge, for styles in Class 7800, (screws No. 94)	27
10 A	Feed Bar Prong Sponge, for styles in Classes 7800, 8300	—
11	Feed Bar Shaft, $3\frac{7}{8}$ inches long, hardened and ground	21
15	Feed Crank Link, (shim No. 1248, screw, $\frac{3}{8}$ inch long, No. 22569, nut No. 7947, screw, $\frac{1}{2}$ inch long, No. 79, obsolete)	18
16	Feed Crank Link Ferrule	13

LIST OF PARTS

Symbol to Order by	The figures in the last column refer only to the plates illustrating the parts and are not to be used in ordering.	Plate No.
17	Feed Crank Stud.....	12
18	Feed Crank Stud Nut; also for Nos. 6037, 6039, 21168 A....	13
19	Feed Crank Stud Cap, for styles having double disc take-up.	13
20	Feed Crank Stud Washer; also for No. 21168 G.....	14
21	Feed Crank Link Pin, hardened and ground.....	13
22 J	Feed Dog, for Nos. 2, 3 and 4 gauge, Style 7000 A.....	6
22 N	Feed Dog, for Nos. $4\frac{1}{2}$, 5, $5\frac{1}{4}$, $5\frac{1}{2}$ and 6 gauge Style 7000 G, and No. 6 gauge Style 7400 N.....	7
22 JE	Feed Dog, for No. $4\frac{1}{2}$ gauge Styles 7200 A, 7200 C; also for Nos. $4\frac{1}{4}$ and $4\frac{1}{2}$ gauge Styles 8200 A, 8200 C, 8200 E, 8200 M, 8200 O.....	7
22 JW	Feed Dog, for No. $4\frac{1}{4}$ gauge Styles 7000 A, 7200 A, 7200 C..	7
22 NA	Feed Dog, for No. 5 gauge Style 8200 N.....	7
22 NB	Feed Dog, for No. $4\frac{1}{4}$ gauge Style 7000 G.....	6
	Screw, $\frac{7}{16}$ inch long, No. 93.	
24	Cloth Plate Gauge, $2\frac{3}{8}$ inch face, (thumbscrew No. 25).....	28
24 DA	Cloth Plate Stay Guide, lower section, for Styles 7200 A, 7200 C, 8200 A, 8200 C.....	34
24 DB	Cloth Plate Stay Guide, upper section, (screw No. 25 C)...	34
25	Thumbscrew, for cloth plate gauges.....	12
25 B	Screw, for presser foot needle guards on styles in Class 7800; also for Nos. 23401, 23401 B.....	11
25 C	Screw, $\frac{9}{32}$ inch long, for cloth plate attachments.....	11
25 S	Screw, for tape reel rod of Styles 7000 G, 7400 N.....	11
25 T	Thumbscrew, for cloth plate slide on Style 7500 T; also for No. 21172 C.....	12
25 CC	Screw, for differential feed indicator stop.....	11
26 D-0	Looper, front, for Nos. $5\frac{1}{4}$, $5\frac{1}{2}$, 6, 28, 30, 32, 34 and 36 gauge styles in Classes 7000, 7400.....	4
26 D-1	Looper, front, for Nos. $4\frac{1}{4}$, $4\frac{1}{2}$ and 5 gauge styles in Classes 7000, 7200, 7400.....	4
26 D-2	Looper, front, for Nos. 1, 2, 3 and 4 gauge styles in Classes 7000, 7400.....	4
26 D-3	Looper, back, for Nos. 2, $4\frac{1}{4}$ and $5\frac{1}{4}$ gauge styles in Classes 7000, 7200, 7400.....	4
26 D-4	Looper, back, for Nos. 4, 5 and 6 gauge styles in Classes 7000, 7200, 7400.....	4
26 D-4 $\frac{1}{2}$	Looper, back, for Nos. 3, $4\frac{1}{2}$ and $5\frac{1}{2}$ gauge styles in Classes 7000, 7200, 7400.....	4
26 M-1	Looper, front, with guard, for Nos. $4\frac{1}{4}$, $4\frac{1}{2}$ and 5 gauge styles in Class 7200.....	5
26 M-2	Looper, front, with guard, for Nos. 1, 2, 3 and 4 gauge styles in Class 7200.....	5
26 N-1	Looper, without guard, otherwise same as No. 26 M-1.....	—
26 N-2	Looper, without guard; otherwise same as No. 26 M-2.....	—
	Looper Set Screw No. 73.	

LIST OF PARTS

Symbol to Order by	The figures in the last column refer only to the plates illustrating the parts and are not to be used in ordering.	Plate No.
28 C	Screw, for adjusting presser foot needle guards and yielding spring guides.	11
30	Looper Rocker Frame, integral cone, hardened, for Styles 7200 T, 8200 V, having double disc take-up (screw, left, No. 88, screw, right, No. 98, spot screw No. 96).	23
31	Looper Rock Shaft, $3\frac{1}{8}$ inches long, hardened and ground, standard diameter, .407 inch, for styles having double disc take-up.	21
31-408	Looper Rock Shaft, standard diameter, plus .001 inch.	—
31-410	Looper Rock Shaft, standard diameter, plus .003 inch.	—
31-413	Looper Rock Shaft, standard diameter, plus .006 inch.	—
31-416	Looper Rock Shaft, standard diameter, plus .009 inch.	—
31-419	Looper Rock Shaft, standard diameter, plus .012 inch.	—
31-422	Looper Rock Shaft, standard diameter, plus .015 inch.	—
32	Looper Rock Shaft, $1\frac{1}{8}$ inches long, hardened and ground, standard diameter .407 inch.	21
32-408	Looper Rock Shaft, standard diameter, plus .001 inch.	—
32-410	Looper Rock Shaft, standard diameter, plus .003 inch.	—
32-413	Looper Rock Shaft, standard diameter, plus .006 inch.	—
32-416	Looper Rock Shaft, standard diameter, plus .009 inch.	—
32-419	Looper Rock Shaft, standard diameter, plus .012 inch.	—
32-422	Looper Rock Shaft, standard diameter, plus .015 inch.	—
33	Looper Rocker Stud, $\frac{7}{32}$ inch diameter, for Styles 7200 T, 8200 V.	12
34	Looper Rocker Stud Nut, for use with $\frac{7}{32}$ inch diameter stud.	13
38 V	Looper Eccentric, throw .174 inch, for Styles 7000 A, 7000 G, 7200 S, (spot screw No. 96).	18
38 X	Looper Eccentric, throw .219 inch, for styles in Classes 7500, 7800, (spot screw No. 96).	18
40	Frame Looper Thread Guide, lower, right.	19
41 A	Hand Lifter, for styles in Classes 7000, 7200, 7400, 8300, (stud No. 86).	24
41 B	Hand Lifter, for styles in Class 8200, (stud No. 86).	24
42 A	Hand Lifter Screw Pin, hardened.	12
43	Feed Lift Eccentric, for Style 8300 K (spot screw No. 96).	18
43 C	Feed Lift Eccentric, for styles in Classes 7000, 7200, 7400, 7500, 8200, (spot screw No. 96).	18
47	Needle Lever Stud Nut.	13
48	Needle Lever Stud Washer, $\frac{7}{16}$ inch hole.	14
50 C-1	Needle Bar, hardened and ground, standard diameter .257 inch, for No. 1 gauge styles in Classes 7200, 7400.	22
50 C-2	Needle Bar, for No. 2 gauge styles in Classes 7000, 7200, 7400.	22
50 C-3	Needle Bar, for No. 3 gauge styles in Classes 7000, 7200, 7400, 7500.	22
50 C-4	Needle Bar, for No. 4 gauge styles in Classes 7000, 7200, 7400, 7500.	22

LIST OF PARTS

Symbol to Order by	The figures in the last column refer only to the plates illustrating the parts and are not to be used in ordering.	Plate No.
50 C-4 $\frac{1}{4}$	Needle Bar, for No. 4 $\frac{1}{4}$ gauge styles in Classes 7000, 7200..	22
50 C-4 $\frac{1}{2}$	Needle Bar, for No. 4 $\frac{1}{2}$ gauge styles in Classes 7000, 7200, 7400, 7500, 7800.....	22
50 C-5	Needle Bar, for No. 5 gauge styles in Classes 7000, 7200, 7400, 7500, 7800.....	22
50 C-6	Needle Bar, for Nos. 5 $\frac{1}{4}$, 5 $\frac{1}{2}$, 6, 28, 30, 32, 34, 36, 40 and 44 gauge styles in Classes 7000, 7400, 7500, 7800, 8200.....	22
	Needle Bar Set Screws, headless, No. 88.	
	Needle Bar Set Screws, fillister head, No. 88 A.	
50 J-40	Needle Stop Pin, for Nos. 36, 40 and 44 gauge styles using No. 50 C-6 needle bar.....	17
52 A	Frame Thread Eyelet, for needle thread intermittent nippers, (screw No. 98 A).....	20
54	Needle Lever Link, hardened.....	24
56 B-2	Needle Clamp Collar, for Nos. 1, 2 and 3 gauge styles in Classes 7000, 7200, 7400, 7500 and Nos. 3 and 4 gauge styles in Classes 8200, 8300.....	19
56 B-4	Needle Clamp Collar, for Nos. 4, 4 $\frac{1}{4}$ and 4 $\frac{1}{2}$ gauge styles in Classes 7000, 7200, 7400, 7500, 7800, and Nos. 4 $\frac{1}{4}$, 4 $\frac{1}{2}$ and 5 gauge styles in Classes 8200, 8300, (needle set screws No. 88 B).....	19
57	Looper Thread Nipper Spring, upper.....	19
57 WB	Needle Bar Thread Nipper Plate.....	19
57 WC	Needle Bar Thread Nipper Spring.....	14
57 WD	Needle Bar Thread Nipper Stud.....	12
58	Looper Thread Nipper Spring, lower, (screw No. 90, operat- ing screw No. 97).....	19
60 A	Presser Bar, hardened and ground, standard diameter .319 inch.....	21
60 A-322	Presser Bar, standard diameter plus .003 inch.....	—
60 A-325	Presser Bar, standard diameter plus .006 inch.....	—
60 A-328	Presser Bar, standard diameter plus .009 inch.....	—
60 A-331	Presser Bar, standard diameter plus .012 inch.....	—
60 A-334	Presser Bar, standard diameter plus .015 inch.....	—
61 C	Presser Bar Connection, (screws, rear, No. 88, screw, front No. 77).....	15
62 A	Presser Guide Bar, hardened and ground, standard diameter .319 inch, for Styles 7400 AH, 7400 AJ.....	21
62 A-322	Presser Guide Bar, standard diameter plus .003 inch.....	—
62 A-325	Presser Guide Bar, standard diameter plus .006 inch.....	—
62 A-328	Presser Guide Bar, standard diameter plus .009 inch.....	—
62 A-331	Presser Guide Bar, standard diameter plus .012 inch.....	—
62 A-334	Presser Guide Bar, standard diameter plus .015 inch.....	—

LIST OF PARTS

Symbol to Order by	The figures in the last column refer only to the plates illustrating the parts and are not to be used in ordering.	Plate No.
62 C	Presser Guide Bar, hardened and ground, standard diameter .319 inch for styles in Classes 7000, 7200, 7500, 7800, 8200, 8300; also Styles 7400 A, 7400 B, 7400 N, 7400 U, 7400 V, 7400 W, 7400 X, 7400 Y, 7400 AA, 7400 AF, 7400 AG, 7400 AK, 7400 AM, 7400 AN.....	21
62 C-322	Presser Guide Bar, standard diameter plus .003 inch.....	—
62 C-325	Presser Guide Bar, standard diameter plus .006 inch.....	—
62 C-328	Presser Guide Bar, standard diameter plus .009 inch.....	—
62 C-331	Presser Guide Bar, standard diameter plus .012 inch.....	—
62 C-334	Presser Guide Bar, standard diameter plus .015 inch.....	—
64 A	Presser Spring Regulating Screw, for styles in Classes 7000, 7200, 7400, 7500, 8200, 8300.....	12
64 B	Presser Spring Regulating Screw Check Nut.....	13
64 X	Presser Spring Regulating Screw, for styles in Class 7800...	12
65 Q-1	Presser Foot, rigid bottom with keel, for Nos. 1 and 2 gauge Styles 7200 A, 7200 T.....	8
65 Q-3	Presser Foot, rigid bottom with keel, for Nos. 3 and 4 gauge Styles 7200 A, 7200 T.....	8
65 Q-4 $\frac{1}{2}$	Presser Foot, rigid bottom with keel, for No. 4 $\frac{1}{4}$ gauge Style 7200 A.....	8
65 BN-2	Presser Foot, hinged, for No. 2 gauge Style 7000 A.....	8
65 BN-3	Presser Foot, hinged, for No. 3 gauge Styles 7000 A, 7500 X...	8
65 BN-4	Presser Foot, hinged, for No. 4 gauge Styles 7000 A, 7500 X	8
65 BN-4 $\frac{1}{4}$	Presser Foot, hinged, for No. 4 $\frac{1}{4}$ gauge Style 7000 A.....	8
65 BN-4 $\frac{1}{2}$	Presser Foot, hinged, for No. 4 $\frac{1}{2}$ gauge Style 7500 X.....	8
65 BN-5	Presser Foot, hinged, for No. 5 gauge Style 7500 X.....	8
65 BT-4 $\frac{1}{4}$	Presser Foot, hinged, for No. 4 $\frac{1}{4}$ gauge Style 7000 G.....	8
65 BT-4 $\frac{1}{2}$	Presser Foot, hinged, for No. 4 $\frac{1}{2}$ gauge Style 7000 G.....	8
65 BT-5	Presser Foot, hinged, for No. 5 gauge Style 7000 G.....	8
65 BT-5 $\frac{1}{4}$	Presser Foot, hinged, for No. 5 $\frac{1}{4}$ gauge Style 7000 G.....	8
65 BT-5 $\frac{1}{2}$	Presser Foot, hinged, for No. 5 $\frac{1}{2}$ gauge Style 7000 G.....	8
65 BT-6	Presser Foot, hinged, for No. 6 gauge Style 7000 G.....	8
65 QH-1	Presser Foot, hinged with keel, for Nos. 1 and 2 gauge Style 7200 C.....	8
65 QH-3	Presser Foot, for Nos. 3 and 4 gauge Style 7200 C.....	8
65 QH-4 $\frac{1}{2}$	Presser Foot, for Nos. 4 $\frac{1}{4}$, 4 $\frac{1}{2}$ and 5 gauge Style 7200 C.....	8
065-1	Presser Foot Clamp Screw No. 91. Presser Foot Needle Guard, for Nos. 1 and 2 gauge Styles 7200 A, 7200 T.....	10
065-3	Presser Foot Needle Guard, for Nos. 3 and 4 gauge Styles 7200 A, 7200 T.....	10
065-4 $\frac{1}{2}$	Presser Foot Needle Guard for Nos. 4 $\frac{1}{4}$, 4 $\frac{1}{2}$ and 5 gauge Style 7200 A..... Presser Foot Needle Guard Screw No. 91 A. Presser Foot Needle Guard Adjusting Screws No. 28 C.	10

LIST OF PARTS

Symbol to Order by	The figures in the last column refer only to the plates illustrating the parts and are not to be used in ordering.	Plate No.
67	Main Shaft Sleeve, left, $1\frac{1}{8}$ inches long, for styles having double disc take-up.	18
68	Main Shaft Sleeve, right, with lug, $1\frac{1}{8}$ inches long, for styles having double disc take-up.	18
68 B	Main Shaft Sleeve, right, without lug, $1\frac{1}{8}$ inches long, for styles having double disc take-up.	18
69 S	Spool Pin, 4 inches long, for thread stands.	38
<input type="checkbox"/> 69 FD	Set Screw, square head, cup point, $\frac{5}{16}$ inch diameter, 18 threads to inch, $\frac{5}{8}$ inch long, for thread stand seats; also for No. 21685.	12
70	Looper Eccentric Sponge Holder and Sponge, (screw No. 93)	27
70 A	Looper Eccentric Sponge.	—
72	Set Screw, for looper eccentric fork.	11
73	Set Screw, for loopers.	11
HA73 B	Set Screw, for differential feed bar link pin, front, in Style 8300 K.	11
75	Stop Screw, for stay cutter operating lever.	11
77	Screw, for feed crank stud cap; also for Nos. 61 C, 1286 A, 5636, 7404 A.	11
78	Set Screw, for lower needle lever link pin.	11
79	Screw, $\frac{1}{3}\frac{1}{2}$ inch long, for feed crank link, obsolete.	11
80	Screw, countersunk head, for cloth plates.	11
81	Spot Screw, for puller driving eccentric.	11
82	Screw, for regulating length of stitch.	12
84 A	Stitch Regulating Ferrule, $\frac{7}{8}$ inch long, for styles in Classes 7000, 7200, 7500, 8200; also Styles 7400 A, 7400 B, 7400 N, 7400 U, 7400 V, 7400 W, 7400 X, 7400 Y, 7400 AA, 7400 AF, 7400 AH, 7400 AJ, 7400 AK, 7400 AM, 7400 AN.	14
84 B	Stitch Regulating Ferrule, $\frac{5}{8}$ inch long, for Style 8300 K.	14
85	Clamp Screw, for looper eccentric fork.	12
86	Hand Lifter Stud; also for Nos. 8362 B, 8365 A.	12
86 A	Hand Lifter Stud, plus size, tap No. V113.	12
86 X	Hinge Screw, for presser feet of Styles 7800 A, 7800 B, 7800 C, 7800 D.	12
87	Screw, for throat plates; also for No. 21390 AS.	11
87 U	Screw, for needle thread pull-off and take-up wires; also for Nos. 3339, 3345 A, 21607.	11
88	Screw, for feed rockers; also for Nos. 9 X, 30, 50 C, 61 C, 160 A, 1288, 2538, 5142, 6093, 6958, 7827 A, 7827 B, 7827 C, 7917, 8362 A, 8362 D, 8566, 8645, 8646, 8647, 15447 E, 15465 F, 21113 B, 21161 D, 23229 C.	11
88 A	Set Screw, fillister head, for needle bars; also for Nos. 142 C, 23401 B.	11
88 B	Set Screw, cup point, for needles.	11

See page 11.

LIST OF PARTS

Symbol to Order by	The figures in the last column refer only to the plates illustrating the parts and are not to be used in ordering.	Plate No.
89	Spot Screw, for looper thread take-ups; also for Nos. 164, 7018 E, 7423 A, 7918-48, 8318.....	11
90	Screw, for looper thread nipper springs; also for Nos. 3346 A, 7225, 8225, 8559, 15447 L, 21172 A, 21172 B, 21390 E, 21640 AB, 21646 C.....	11
91	Clamp Screw, for presser feet.....	11
91 A	Screw, for presser foot adjustable guards on Styles 7200 A, 7200 T, 8200 A, 8200 V; also for No. 8235.....	11
92	Stop Screw, for cloth plate slide on Style 8300 K.....	11
93	Screw, $\frac{7}{16}$ inch long, for feed dogs of styles in Classes 7000, 7200, 7400, 7500, 8200; also for Nos. 7 H, 70, 104, 120 A, 3348, 5150, 7484 A, 7638 A, 8366 A, 8367 A, 8369 A, 8370 A, 15447 K, 21396 AC, 23229 B.....	11
93 A	Screw, $\frac{9}{32}$ inch long, for feed dogs of styles in Class 7800; also for Nos. 416 A, 7201 T, 7401 R, 7801, 8301 M, 8501, 21170, 21170 A.....	11
94	Screw, for looper eccentric fork shoe; also for Nos. 10, 202 A, 7825 A, 7825 B, 7825 D, 8567, 9932, 15447 G, 21172, 21602, 21603, 23296 A, 23401, 23401 A, 23401 C, 23402 B.....	11
95	Screw, for main shaft collar.....	11
96	Spot Screw, for looper rocker frames; also for Nos. 38 V, 38 X, 43, 43 C, 1054, 6606.....	11
97	Operating Screw, for looper thread nipper springs, also for Nos. 103 A, 3338 A, 7656.....	11
98	Screw, right, for looper rocker frame; also for Nos. 459, 482, 21161 C, 21661, 21703, 21703 C.....	11
98 A	Screw, for needle lever and frame thread eyelets; also for No. 8371 A.....	11
100 B	Thread Stand Wire, 16 inches long, (set screw, square head, 24 threads to inch, No. 22632 F-24, Set screw, headless, 24 threads to inch, No. 22813, obsolete).....	35
101 V	Looper Thread Take-up, double disc type, (spot screw No. 89)	20
102	Looper Thread Take-up Eyelet Stand, (screws No. 22596)...	24
103 A	Looper Thread Take-up Eyelet, for No. 40 and narrower gauge styles having double disc take up, (adjusting screw No. 97).....	20
104	Looper Thread Take-up Eyelet Spring, (screw No. 93).....	17
105-2 $\frac{1}{2}$	Thumbscrew, 2 $\frac{1}{2}$ inches long, for fastening machine to table..	28
105-3	Thumbscrew, 3 inches long.....	28
105-3 $\frac{1}{2}$	Thumbscrew, 3 $\frac{1}{2}$ inches long.....	28
106 A	Tension Post, lower, for looper thread.....	18
107	Tension Spring Ferrule.....	13
108	Tension Regulating Nut, knurled.....	13
109	Tension Disc, hardened and lapped.....	14
V109	Tap, marked, "J2", for No. 22526.....	17

LIST OF PARTS

Symbol to Order by	The figures in the last column refer only to the plates illustrating the parts and are not to be used in ordering.	Plate No.
110-1	Tension Spring, .026 inch, diameter wire, for looper threads on styles in Classes 7000, 7200, 7400, 7500, 8200, 8300	14
110-2	Tension Spring, .028 inch diameter wire, for looper threads on styles in Class 7800	14
110-3	Tension Spring, .040 inch diameter wire, for needle threads on styles in Classes 7000, 7200; also Styles 8200 A, 8200 B, 8200 C, 8200 E, 8200 M, 8200 N, 8200 O, 8200 S, 8200 V, 8200 W; also for Nos. 21172 C, 21182 N	14
110-4	Tension Spring, .048 inch diameter wire, for needle threads on styles in Classes 7500, 7800; also Style 8200 T	14
V113	Tap, marked "Q2", for No. 86 A	17
116	Wrench, for $\frac{1}{4}$ inch hexagon nuts	28
118	Thread Hook, for looper threads	28
118 B	Thread Tweezers	28
V118	Tap, marked "X2", for No. 22521	17
119	Stay Box Assembly, for Styles 7200 A, 7200 C, 7200 T, 8200 A, 8200 C, 8200 V	39
119 A	Stay Box Cover Pivot Stud	—
119 B	Stay Box Cover	—
119 C	Stay Box	—
120 A	Upper Tape Guide, for Style 7000 G, (screw No. 93)	24
137	Thread Controller Thread Eyelet, for styles in Classes 7000, 7400, 7500, 7800, 8300	20
138	Screw, for thread controller thread eyelet	11
† 139 A	Needle Thread Controller Lever Assembly	24
141	Needle Thread Controller Lever Screw	12
142 C	Thread Controller Rack and Presser Spring Rest, (screw No. 88 A)	24
143 B	Needle Thread Pull-off and Take-up Wire, for Styles 7400 U, 7400 V, 7400 W, 7400 X, 7400 Y, 7400 AA, 7400 AF, 7400 AH, 7400 AJ, 7400 AK, 7400 AM, 7400 AN, (screw No. 87 U)	19
150	Stop Screw, for cloth plate slides	11
154	Needle Lever Buffer, wood fibre	17
156	Needle Lever Ball, hardened	12
158	Needle Lever Thread Eyelet, right, (screw No. 98 A)	20
158 B	Needle Lever Thread Eyelet, left, for styles in Classes 7000, 7400, 7500, 7800, 8300, (screw No. 98 A)	20
160 A-00	Needle Bar, hardened and ground, standard diameter .257 inch, for No. 00 gauge styles in Class 8200	22
160 A-0	Needle Bar, for No. 0 gauge styles in Class 8200	22
160 A-1	Needle Bar, for No. 1 gauge styles in Class 8200	22
160 A-2	Needle Bar, for No. 2 gauge styles in Class 8200	22
160 A-3	Needle Bar, for No. 3 gauge styles in Class 8200	22
160 A-4	Needle Bar, for No. 4 gauge styles in Classes 8200, 8300	22
160 A-4 $\frac{1}{4}$	Needle Bar, for No. 4 $\frac{1}{4}$ gauge styles in Class 8200	22

† See page 11.

LIST OF PARTS

Symbol to Order by	The figures in the last column refer only to the plates illustrating the parts and are not to be used in ordering.	Plate No.
160 A-4 $\frac{1}{2}$	Needle Bar, for No. 4 $\frac{1}{2}$ gauge styles in Classes 8200, 8300 . . .	22
160 A-5	Needle Bar, for No. 5 gauge styles in Class 8200	22
	Needle Bar Set Screws, headless, No. 88.	
	Needle Bar Set Screws, fillister head, No. 88 A.	
161	Needle Bar Stop Collar, for Styles in Class 8200	13
162	Needle Bar Connection	18
164-1	Needle Clamp Collar, for Nos. 00, 0, 1 and 2 gauge styles in Class 8200, (screw No. 89, needle set screw No. 88 B)	24
168	Presser Spring, for styles in Classes 7000, 7200, 7400, 8200, 8300	34
168 B	Presser Spring, for styles in Class 7500	34
168 X	Presser Spring, for styles in Class 7800	34
169	Main Shaft, hardened and ground, standard diameter .530 inch, for styles having double disc take-up in Classes 7000, 7200, 7500, 8200, 8300; also Styles 7400 A, 7400 B, 7400 N, 7400 U, 7400 V, 7400 W, 7400 X, 7400 Y, 7400 AA, 7400 AF, 7400 AH, 7400 AJ, 7400 AK	35
169-531	Main Shaft, standard diameter plus .001 inch	—
169-533	Main Shaft, standard diameter plus .003 inch	—
169-536	Main Shaft, standard diameter plus .006 inch	—
169-539	Main Shaft, standard diameter plus .009 inch	—
169-542	Main Shaft, standard diameter plus .012 inch	—
173 A	Feed Dog, for No. 0 gauge Style 8200 T	5
173 B	Feed Dog, for No. 2 gauge Style 8200 T	7
174 A-1	Feed Dog, for No. 1 gauge Style 8200 T	5
174 A-3	Feed Dog, for No. 3 gauge Style 8200 T	5
174 A-4	Feed Dog, for No. 4 gauge Style 8200 T	5
174 A-4 $\frac{1}{4}$	Feed Dog, for No. 4 $\frac{1}{4}$ gauge Style 8200 T	5
174 A-4 $\frac{1}{2}$	Feed Dog, for No. 4 $\frac{1}{2}$ gauge Style 8200 T	5
174 A-5	Feed Dog, for No. 5 gauge Style 8200 T	5
174 A-5 $\frac{1}{4}$	Feed Dog, for No. 5 $\frac{1}{4}$ gauge Style 8200 T	5
174 A-5 $\frac{1}{2}$	Feed Dog, for No. 5 $\frac{1}{2}$ gauge Style 8200 T	5
	Feed Dog Screw, $\frac{7}{16}$ inch long, No. 93.	
176	Looper, front, with guard, for styles in Classes 8200, 8300	5
176 A	Looper, without guard, otherwise same as No. 176	—
176 B-00	Looper, back, for No. 00 gauge styles in Class 8200	5
176 B-0	Looper, back, for No. 0 gauge styles in Class 8200	5
176 B-1	Looper, back, for No. 1 gauge styles in Class 8200	5
176 B-2	Looper, back, for No. 2 gauge styles in Class 8200	5
176 B-3	Looper, back, for No. 3 gauge styles in Class 8200	5
176 B-4	Looper, back, for No. 4 gauge styles in Classes 8200, 8300	5
176 B-4 $\frac{1}{2}$	Looper, back, for Nos. 4 $\frac{1}{4}$ and 4 $\frac{1}{2}$ gauge styles in Class 8200	5
176 B-5	Looper, back, for No. 5 gauge, styles in Class 8200	5
176 B-5 $\frac{1}{4}$	Looper, back, for No. 5 $\frac{1}{4}$ gauge styles in Class 8200	5
176 B-5 $\frac{1}{2}$	Looper, back, for No. 5 $\frac{1}{2}$ gauge styles in Class 8200	5

LIST OF PARTS

Symbol to Order by	The figures in the last column refer only to the plates illustrating the parts and are not to be used in ordering.	Plate No.
178	Looper, front, with guard, for Nos. 4, 4½, 5, 5½ and 6 gauge Style 7500 B, No. 3 gauge Style 7500 T, Nos. 3, 4, 4½ and 5 gauge Style 7500 X, Nos. 5, 5½, 6 and 32 gauge Styles 7800 A, 7800 C, Nos. 5, 5½ and 6 gauge Styles 7800 B, 7800 D, No. 4½ gauge Style 7800 F.....	5
178 A	Looper, without guard, otherwise same as No. 178.....	—
178 B-3	Looper, back, for No. 3 gauge Styles 7500 T, 7500 X.....	4
178 B-4	Looper, back, for No. 4 gauge Styles 7500 B, 7500 X.....	4
178 B-4½	Looper, back, for No. 4½ gauge Styles 7500 B, 7500 X, 7800 F.....	4
178 B-5	Looper, back, for No. 5 gauge Styles 7500 B, 7500 X, 7800 A, 7800 B, 7800 C, 7800 D.....	4
178 B-5½	Looper, back, for No. 5½ gauge Styles 7500 B, 7800 A, 7800 B, 7800 C, 7800 D.....	4
178 B-6	Looper, back, for No. 6 gauge Styles 7500 B, 7800 A, 7800 B, 7800 C, 7800 D.....	4
	Looper Set Screw No. 73.	
182	Looper Rocker, hardened, for styles in Classes 7400, 8200, 8300.....	25
183	Looper Rocker, hardened, for styles in Classes 7000, 7200..	25
183 A	Looper Rocker, hardened, for styles in Classes 7500, 7800..	25
185 A-1	Throat Plate, for No. 1 gauge Style 8200 S.....	1
185 A-2	Throat Plate, for No. 2 gauge Style 8200 S.....	1
185 A-3	Throat Plate, for No. 3 gauge Style 8200 S.....	1
185 B-0	Throat Plate, for No. 0 gauge Style 8200 T.....	2
185 B-1	Throat Plate, for No. 1 gauge Style 8200 T.....	2
185 B-2	Throat Plate, for No. 2 gauge Style 8200 T.....	2
185 B-3	Throat Plate, for No. 3 gauge Style 8200 T.....	2
185 B-4	Throat Plate, for No. 4 gauge Style 8200 T.....	2
185 B-4¼	Throat Plate, for No. 4¼ gauge Style 8200 T.....	2
185 B-4½	Throat Plate, for No. 4½ gauge Style 8200 T.....	2
185 B-5	Throat Plate, for No. 5 gauge Style 8200 T.....	2
185 B-5¼	Throat Plate, for No. 5¼ gauge Style 8200 T.....	2
185 B-5½	Throat Plate, for No. 5½ gauge Style 8200 T.....	2
185 AT-5	Throat Plate, for No. 5 gauge Style 8200 N.....	2
	Throat Plate Screws No. 87.	
187 A	Screw, for cloth plate guard cushion; also for Nos. 3336 C, 3345 A, 7040-6, 7040-33, 7040-48, 8344.....	11
188 A-0	Needle Guide Foot, for No. 0 gauge Style 8200 T, (clamp screw No. 91).....	9
188 D	Set Screw, knurled head, for roller support swinging arm... ..	12
194	Hand Lifter for styles in Classes 7500, 7800, (stud No. 86)..	24
195 A-1	Throat Plate, for No. 1 gauge Style 7200 S.....	1
195 A-2	Throat Plate, for No. 2 gauge Styles 7200 A, 7200 S.....	1
195 A-3	Throat Plate, for No. 3 gauge Styles 7200 A, 7200 S.....	1
195 A-4	Throat Plate, for No. 4 gauge Style 7000 A.....	1
195 A-4¼	Throat Plate, for No. 4¼ gauge Styles 7000 A, 7200 A, 7200 C	1

LIST OF PARTS

Symbol to Order by	The figures in the last column refer only to the plates illustrating the parts and are not to be used in ordering.	Plate No.
195 Y-6	Throat Plate, for No. 6 gauge Styles 7800 A, 7800 B, 7800 C, 7800 D.....	2
195 Y-32	Throat Plate, for No. 32 gauge Styles 7800 A, 7800 C.....	2
195 AT-4 $\frac{1}{4}$	Throat Plate, for No. 4 $\frac{1}{4}$ gauge Style 7000 G.....	1
195 AT-4 $\frac{1}{2}$	Throat Plate, for No. 4 $\frac{1}{2}$ gauge Style 7000 G.....	1
195 AT-5	Throat Plate, for No. 5 gauge Style 7000 G.....	1
195 AT-5 $\frac{1}{4}$	Throat Plate, for No. 5 $\frac{1}{4}$ gauge Style 7000 G.....	1
195 AT-5 $\frac{1}{2}$	Throat Plate, for No. 5 $\frac{1}{2}$ gauge Style 7000 G.....	1
195 AT-6	Throat Plate, for No. 6 gauge Styles 7000 G, 7400 N..... Throat Plate Screws No. 87.	1
197 C	Feed Dog, for Nos. 1, 2 and 3 gauge Styles 7200 S, 8200 S..	7
197 Y	Feed Dog, for No. 6 gauge Styles 7800 A, 7800 B, 7800 C, 7800 D.....	7
197 Y-32	Feed Dog, for No. 32 gauge Styles 7800 A, 7800 C..... Feed Dog Screw, $\frac{9}{32}$ inch long, No. 93 A.	7
198 A-4	Presser Foot, hinged, for No. 4 gauge Style 7500 B.....	8
198 A-4 $\frac{1}{2}$	Presser Foot, hinged, for No. 4 $\frac{1}{2}$ gauge Style 7500 B.....	8
198 A-5	Presser Foot, hinged, for No. 5 gauge Style 7500 B.....	8
198 A-5 $\frac{1}{2}$	Presser Foot, hinged, for No. 5 $\frac{1}{2}$ gauge Style 7500 B.....	8
198 A-6	Presser Foot, hinged, for No. 6 gauge Style 7500 B.....	8
198 B-1	Presser Foot, hinged, for No. 1 gauge Style 7400 A.....	8
198 B-2	Presser Foot, hinged, for No. 2 gauge Style 7400 A.....	8
198 B-3	Presser Foot, hinged, for No. 3 gauge Style 7400 A.....	8
198 B-4	Presser Foot, hinged, for No. 4 gauge Styles 7400 A, 7400 B.	8
198 B-4 $\frac{1}{2}$	Presser Foot, hinged, for No. 4 $\frac{1}{2}$ gauge Styles 7400 A, 7400 B	8
198 B-5	Presser Foot, hinged, for No. 5 gauge Style 7400 B.....	8
198 B-5 $\frac{1}{2}$	Presser Foot, hinged, for No. 5 $\frac{1}{2}$ gauge Style 7400 B.....	8
198 B-6	Presser Foot, hinged, for No. 6 gauge Style 7400 B.....	8
198 C-1	Presser Foot, hinged, for No. 1 gauge Style 7200 S.....	8
198 C-2	Presser Foot, hinged, for No. 2 gauge Style 7200 S.....	8
198 C-3	Presser Foot, hinged, for No. 3 gauge Style 7200 S..... Presser Foot Clamp Screw No. 91.	8
199 A	Presser Foot Needle Guard, for No. 7827 A-6, (screws No. 25B)	10
201 A	Lower Tape Reel Frame for Styles 7400 U, 7400 V, 7400 W, 7400 X, 7400 Y, 7400 AA, 7400 AF, 7400 AG, 7400 AH, 7400 AM, 7400 AN.....	39
201 C	Thumbscrew, for lower tape reel axle.....	12
202 A	Needle Thread Pull-off and Take-up Wire Post, for styles in Classes 7500, 7800; also Styles 7000 A, 7400 U, 7400 V, 7400 W, 7400 X, 7400 Y, 7400 AA, 7400 AF, 7400 AG, 7400 AH, 7400 AJ, 7400 AK, 7400 AM, 7400 AN, (screw No. 94).....	19
202 B	Needle Thread Take-up Wire for styles in Class 7500; also Styles 7000 A, 7400 U, 7400 V, 7400 W, 7400 X, 7400 Y, 7400 AA, 7400 AF, 7400 AG, 7400 AH, 7400 AJ, 7400 AK, 7400 AM, 7400 AN, (screw No. 87 U).....	19

LIST OF PARTS

Symbol to Order by	The figures in the last column refer only to the plates illustrating the parts and are not to be used in ordering.	Plate No.
269	Looper Connecting Rod Nut, left thread.....	13
294	Adjusting Screw, for reciprocating needle rear guard frame..	12
413	Oil Can, with spout.....	38
416 A	Lifter Lever Extension, (screw, $\frac{1}{3}\frac{3}{2}$ inch long, No. 93, screw, $\frac{9}{3}\frac{1}{2}$ inch long, No. 93 A).....	35
416 B	Lifter Lever Casting.....	35
420	Lifter Lever Stud.....	12
421	Lifter Lever Chain, 38 inches long.....	28
422	Lifter Treadle.....	36
423	Lifter Treadle Base.....	26
424	Lifter Treadle Pin, (set screw 24 threads to inch, No. 22813, set screw 32 threads to inch, No. 98, obsolete).....	21
426	Lifter Lever Spring.....	14
426 A	Lifter Lever Spring Pin.....	17
430	Tape Reel Axle, for Styles 7000 G, 7400 N, using tape from $\frac{1}{2}$ inch to $1\frac{3}{16}$ inches wide.....	17
430 A	Tape Reel Axle, for Style 7400 U, using tape from 1 inch to $1\frac{5}{8}$ inches wide.....	17
430 B	Tape Reel Axle, for Style 7500 T, using tape from $1\frac{1}{2}$ to $2\frac{3}{8}$ inches wide.....	17
431 A	Tape Reel Spring Latch.....	25
432	Tape Reel Tension Spring.....	14
433	Tape Reel Tension Nut, knurled.....	13
434	Tape Reel Tension Lock Nut, knurled.....	13
454 A	Needle Lever Ball Clamp Bolt Washer.....	14
459	Stay Cutter Operating Lever Shaft, for Styles 7200 T, 8200 V, (set screw No. 98).....	21
482	Collar, for floating design feed rocker shaft, (screw No. 98).....	24
Y500-257	Expansion Reamer, for needle bars size .257 inch.....	37
Y502-319	Expansion Reamer, for presser bars and presser guide bars, size .319 inch.....	37
Y502-322	Expansion Reamer, size .322 inch.....	—
Y502-325	Expansion Reamer, size .325 inch.....	—
Y502-328	Expansion Reamer, size .328 inch.....	—
Y502-331	Expansion Reamer, size .331 inch.....	—
503 A-1	Presser Foot, rigid bottom with keel, for Nos. 1 and 2 gauge Styles 8200 A, 8200 V.....	8
503 A-3	Presser Foot, for Nos. 3 and 4 gauge Styles 8200 A, 8200 V..	8
503 A-4 $\frac{1}{2}$	Presser Foot, for Nos. 4 $\frac{1}{4}$ and 4 $\frac{1}{2}$ gauge Style 8200 A.....	8
503 C-1	Presser Foot, rigid bottom, for No. 1 gauge Style 8200 E....	8
503 C-2	Presser Foot, for No. 2 gauge Style 8200 E.....	8
503 C-3	Presser Foot, for No. 3 gauge Style 8200 E.....	8
503 C-4	Presser Foot, for No. 4 gauge Style 8200 E.....	8
503 C-4 $\frac{1}{4}$	Presser Foot, for No. 4 $\frac{1}{4}$ gauge Style 8200 E.....	8
503 C-4 $\frac{1}{2}$	Presser Foot, for No. 4 $\frac{1}{2}$ gauge Style 8200 E.....	8

LIST OF PARTS

Symbol to Order by	The figures in the last column refer only to the plates illustrating the parts and are not to be used in ordering.	Plate No.
503 C-5	Presser Foot, for No. 5 gauge Style 8200 E..... Presser Foot Clamp Screw No. 91.	8
Y505-407	Expansion Reamer, for feed rocker shafts and feed bar shaft size .407 inch.....	37
Y505-410	Expansion Reamer, size .410 inch.....	—
Y505-413	Expansion Reamer, size .413 inch.....	—
Y505-416	Expansion Reamer, size .416 inch.....	—
Y505-419	Expansion Reamer, size .419 inch.....	—
Y506-530	Expansion Reamer, for main shafts, size .530 inch.....	37
Y506-533	Expansion Reamer, size .533 inch.....	—
Y506-536	Expansion Reamer, size .536 inch.....	—
Y506-539	Expansion Reamer, size .539 inch.....	—
600-1- $\frac{1}{16}$	Double Lap Seam Feller, pivot adjustment, under ply of fabric passes to right of needles $\frac{1}{16}$ inch capacity, for No. 1 gauge Style 7400 A.....	30
600-2- $\frac{1}{16}$	Double Lap Seam Feller, $\frac{1}{16}$ inch capacity, for No. 2 gauge..	30
600-3- $\frac{1}{32}$	Double Lap Seam Feller, $\frac{1}{32}$ inch capacity, for No. 3 gauge	30
600-3- $\frac{1}{16}$	Double Lap Seam Feller, $\frac{1}{16}$ inch capacity, for No. 3 gauge..	30
600-3- $\frac{3}{32}$	Double Lap Seam Feller, $\frac{3}{32}$ inch capacity, for No. 3 gauge..	30
600-4- $\frac{1}{16}$	Double Lap Seam Feller, $\frac{1}{16}$ inch capacity, for No. 4 gauge Styles 7400 A, 7400 B, 7500 B.....	30
600-4- $\frac{3}{32}$	Double Lap Seam Feller, $\frac{3}{32}$ inch capacity, for No. 4 gauge..	30
600-4- $\frac{7}{64}$	Double Lap Seam Feller, $\frac{7}{64}$ inch capacity, for No. 4 gauge..	30
600-4- $\frac{1}{2}$ - $\frac{1}{16}$	Double Lap Seam Feller, $\frac{1}{16}$ inch capacity, for No. 4 $\frac{1}{2}$ gauge.	30
600-4- $\frac{1}{2}$ - $\frac{5}{64}$	Double Lap Seam Feller, $\frac{5}{64}$ inch capacity, for No. 4 $\frac{1}{2}$ gauge.	30
600-4- $\frac{1}{2}$ - $\frac{3}{32}$	Double Lap Seam Feller, $\frac{3}{32}$ inch capacity, for No. 4 $\frac{1}{2}$ gauge.	30
600-4- $\frac{1}{2}$ - $\frac{7}{64}$	Double Lap Seam Feller, $\frac{7}{64}$ inch capacity, for No. 4 $\frac{1}{2}$ gauge.	30
600-5- $\frac{1}{16}$	Double Lap Seam Feller, $\frac{1}{16}$ inch capacity, for No. 5 gauge Styles 7400 B, 7500 B.....	30
600-5- $\frac{5}{64}$	Double Lap Seam Feller, $\frac{5}{64}$ inch capacity, for No. 5 gauge..	30
600-5- $\frac{3}{32}$	Double Lap Seam Feller, $\frac{3}{32}$ inch capacity, for No. 5 gauge..	30
600-5- $\frac{7}{64}$	Double Lap Seam Feller, $\frac{7}{64}$ inch capacity, for No. 5 gauge..	30
600-5- $\frac{1}{8}$ - $\frac{1}{64}$	Double Lap Seam Feller, $\frac{1}{64}$ inch capacity, for No. 5 gauge..	30
600-5- $\frac{1}{2}$ - $\frac{1}{16}$	Double Lap Seam Feller, $\frac{1}{16}$ inch capacity, for No. 5 $\frac{1}{2}$ gauge.	30
600-5- $\frac{1}{2}$ - $\frac{9}{64}$	Double Lap Seam Feller, $\frac{9}{64}$ inch capacity, for No. 5 $\frac{1}{2}$ gauge.	30
600-6- $\frac{1}{16}$	Double Lap Seam Feller, $\frac{1}{16}$ inch capacity, for No. 6 gauge.. Double Lap Seam Feller Screws No. 25 C.	30
604	Adjusting Screw, $\frac{1}{8}$ inch long, for double lap seam fellers....	11
605	Adjusting Screw, $\frac{5}{32}$ inch long, for double lap seam fellers...	11
605 A	Adjusting Screw, $\frac{3}{16}$ inch long, for double lap seam fellers; also for No. 7933-48.....	11
606-1	Folder and Guide, upper ply of fabric passes to right of needles, for No. 1 gauge Style 7200 S.....	30
606-2	Folder and Guide, for No. 2 gauge Style 7200 S.....	30
606-3	Folder and Guide, for No. 3 gauge Style 7200 S.....	30

LIST OF PARTS

Symbol to Order by	The figures in the last column refer only to the plates illustrating the parts and are not to be used in ordering.	Plate No.
606 A-1	Folder and Guide, upper ply of fabric passes to left of needles, for No. 1 gauge Style 8200 S.	30
606 A-2	Folder and Guide, for No. 2 gauge Style 8200 S.	30
606 A-3	Folder and Guide, for No. 3 gauge Style 8200 S (Screws No. 25 C).....	30
<input type="checkbox"/> 650-24	Stove Bolt, flat head $\frac{1}{4}$ x 3 inches.	—
<input type="checkbox"/> 650-28	Stove Bolt, flat head $\frac{1}{4}$ x $3\frac{1}{2}$ inches.	—
<input type="checkbox"/> 650-40	Stove Bolt, flat head $\frac{1}{4}$ x 5 inches.	—
<input type="checkbox"/> 660-31	Ball, .0625 inch diameter for rolling presser foot.	14
<input type="checkbox"/> 660-62	Oil Cup, for right hand main shaft bearing on styles with annular take-up.....	27
Y800	Taper Reamer, for lever end of needle lever stud.	—
Y801	Taper Reamer, for frame end of needle lever stud.	—
Y802	Taper Reamer, for needle lever link pins and feed crank link pins.	37
906 A	Clamp Screw, for needle lever link pin, on styles with lynite needle lever.	12
907	Lock Nut, for needle lever link pin clamp screw; also for No. 75.	13
1000	Thread Lubricator Assembly; attaches to tension thread eyelet, thread lubricated before entering tension.	27
1002	Thread Lubricator Cup.	27
1003	Thread Lubricator Cup Pin.	—
1004	Thread Lubricator Cup Felt.	27
1005	Thread Lubricator Bracket, (screw No. 95).....	27
1007	Thread Lubricator Tension Plate, (tension post No. 1346, tension post ferrule No. 1347, tension spring No. 110-2, tension spring ferrule No. 107, tension regulating nut No. 108).....	15
1008	Thread Lubricator Tension Felt, lower.	15
1054	Looper Eccentric, ground, throw .152 inch, for styles in Classes 7400, 8200; also Styles 7200 A, 7200 C, 7200 T, 8300 K, (spot screw No. 95).....	18
1221	Eccentric Pulley, throw .529 inch, for styles in Classes 7000, 7200, (screws No. 22597).....	26
† 1230 A	Needle Lever Connecting Rod Upper Bearing, (screws No. 22587).....	25
1230 B	Needle Lever Connecting Rod Upper Bearing Valve Spring..	14
1230 C	Needle Lever Connecting Rod Tube, (nut, left thread, No. 15430 C, nut, right thread, No. 15430 D).....	21
1230 D	Needle Lever Connecting Rod Upper Bearing Valve, (valve screw No. 22586 A).....	13
† 1230 G	Needle Lever Connecting Rod Lower Bearing, wick and splash feed oiling, (screws No. 22587).....	26
1248	Feed Crank Link Shim, leather.	14

See page 11.
 † See page 11.

LIST OF PARTS

Symbol to Order by	The figures in the last column refer only to the plates illustrating the parts and are not to be used in ordering.	Plate No.
1261	Looper Rocker Frame, detachable cone design, for styles having double disc take-up in Classes 7000, 7400, 7500, 7800, 8300; also Styles 7200 A, 7200 C, 7200 S, 8200 A, 8200 C, 8200 E, 8200 M, 8200 N, 8200 O, 8200 S, 8200 T, 8200 W, (screw, left, No. 88, screw, right, No. 98, spot screw No. 96).....	23
1275 A	Needle Lever Stud, taper bearing, standard diameter.....	25
1275 E	Needle Lever Stud, plus size on <i>frame</i> section, viz.: .001, .002, .003, .006, .012, .018 inch; specify plus amount. Example: 1275 E-003 represents a stud plus .003 inch on <i>frame</i> section.....	—
1275 F	Needle Lever Stud, plus size on <i>lever</i> section, viz.: .001, .002, .003, .007 inch; specify plus amount. Example: 1275 F-003 represents a stud plus .003 inch on <i>lever</i> section....	—
1275 H	Needle Lever Stud, plus size equal on <i>each</i> section; viz.: .001, .002, .003, .006 inch; specify plus amount. Example: 1275 H-003 represents a stud plus .003 inch on <i>each</i> section.	—
1275 J	Needle Lever Stud, plus size unequal on each section, viz.: (.001, .002) (.001, .003) (.001, .006) (.002, .001) (.002, .003) (.002, .006) (.003, .001) (.003, .002) (.003, .006) (.006, .001) (.006, .002) (.006, .003) (.012, .001) (.012, .002) (.012, .003) (.012, .006) (.018, .001) (.018, .002) (.018, .003) (.018, .006) Specify plus amounts, arranged <i>frame</i> section first and <i>lever</i> section last. Example: 1275 J-003-006 represents a stud plus .003 inch on <i>frame</i> section and .006 inch on <i>lever</i> section, 1275 J-006-003 represents a stud plus .006 inch on <i>frame</i> section and .003 inch on <i>lever</i> section, (screw No. 22586)..... Needle Lever Stud Felt No. 15430 L. Note: Before lapping the bearing of a needle lever and a needle lever stud remove the felt from the stud and replace it after the lapping compound has been washed out.	—
1276	Needle Lever Stud, cone bearing, hardened and ground, (nut No. 47, washer No. 48).....	25
1280	Needle Lever Stud Ball Clamp Bolt Nut; also for No. 15745 B	13
1286	Needle Lever Link Pin Assembly, internal oiling, hardened and ground, one each Nos. 1286 A, 1286 B, 12964 C, 22560; also for No. 8360.....	13
1286 A	Needle Lever Link Pin, (set screw, upper, No. 77, set screw, lower, No. 78, clamp screw No. 906 A, lock nut No. 907).. Needle Lever Link Pin Ball No. 12964 C.	13
1286 B	Needle Lever Link Pin Spring, (screw No. 22560).....	14
1287	Needle Bar Thread Nipper Assembly; one each Nos. 57 WB, 57 WC, 57 WD, 88, 1288.....	19
1288	Needle Bar Thread Nipper Collar, (screw No. 88).....	19

LIST OF PARTS

Symbol to Order by	The figures in the last column refer only to the plates illustrating the parts and are not to be used in ordering.	Plate No.
1346	Tension Post, $1\frac{1}{6}$ inches long, for use with hardened steel ferrule.....	18
1347	Tension Post Ferrule.....	13
1349	Tension Spring, .036 inch diameter wire, for needle threads on styles in Classes 7400, 8300.....	14
1361 A	Presser Spring Pin.....	14
1362	Main Shaft Sleeve Pin.....	17
1520 M-13	Rolling Presser Foot Assembly, ball bearing design, universal adjustment, diameter of roller $\frac{1}{8}$ inch, width of face $\frac{3}{16}$ inch, for Style 8200 T.....	9
1520 M-18	Rolling Presser Foot Assembly, diameter of roller $1\frac{1}{8}$ inches, width of face $\frac{3}{16}$ inch.....	9
1520 M-21	Rolling Presser Foot Assembly, diameter of roller $1\frac{5}{16}$ inches, width of face $\frac{3}{16}$ inch.....	9
1520 N-28	Presser Foot Assembly, diameter of roller $1\frac{3}{4}$ inches, width of face $\frac{1}{4}$ inch.....	9
1580 G-13	Roller, $\frac{1}{8}$ inch diameter, $\frac{3}{16}$ inch face.....	—
1580 G-18	Roller, $1\frac{1}{8}$ inches diameter, $\frac{3}{16}$ inch face.....	—
1580 G-21	Roller, $1\frac{5}{16}$ inches diameter, $\frac{3}{16}$ inch face.....	—
1580 H-28	Roller, $1\frac{3}{4}$ inches diameter, $\frac{1}{4}$ inch face, (axle screw No. 22818, lock screw No. 22743).....	—
1584	Roller Support, adjustable, (set screw, hexagon head, No. 22519).....	—
1592 B	Roller Support Swinging Arm, adjustable, (set screw, knurled head, No. 188 D, stop screw No. 22575, hinge pin No. 1594 A).....	—
1592 C	Roller Support Swinging Arm Bracket, lower, adjustable, (screw No. 22548).....	—
1593 C	Roller Support Swinging Arm Bracket, upper, (set screws No. 22584).....	—
1593 E	Roller Support Swinging Arm Bracket, intermediate, adjustable, (screws No. 22548).....	—
1594 A	Roller Support Swinging Arm Hinge Pin.....	—
2538	Thread Controller Rack and Presser Spring Rest Collar, (screw No. 88).....	13
3335 A	Stay Cutter Knife, for Styles 7200 T, 8200 V.....	15
3336 B	Stay Cutter Knife Returning Spring, (stud No. 9675).....	15
3336 C	Stay Cutter Knife Pressure Spring, (screw No. 187 A).....	15
3338 A	Stay Cutter Knife Guide, (screws No. 97).....	15
3339	Stay Cutter Knife Plate, adjustable, (screws No. 87 U).....	15
3340	Stay Feeder.....	15
3341	Stay Feeder Stud.....	12
3342	Stay Feeder Spring.....	15
3343	Stay Feeder Spring Pin.....	15
3344	Stay Guide, adjustable, (screw No. 87 U).....	15
3345 A	Stay Retaining Spring, (screw No. 187 A).....	15

LIST OF PARTS

Symbol to Order by	The figures in the last column refer only to the plates illustrating the parts and are not to be used in ordering.	Plate No.
3346	Stay Cutter Operating Lever, (stop screws No. 75, lock nut No. 907).....	15
3346 A	Stay Cutter Operating Lever Spring, (screw No. 90).....	15
3348	Stay Cutter Knife Lifter, (screw No. 93).....	15
3349	Stay Cutter Operating Lever Chain Ring.....	15
4937	Differential Feed Controlling Shaft Operating Lever Stud, for Style 8300 K.....	12
5142	Feed Bar, for styles in Class 7800, (screws No. 88).....	23
5143	Differential Feed Bar, for Style 8300 K.....	23
5150	Main Feed Dog Holder, for Style 8300 K, (screw No. 93)...	14
5157	Feed Rocker Arm, for Style 8300 K, having double disc take-up, (screws No. 22548).....	23
5636	Reciprocating Needle Rear Guard Frame Shoe, hardened and ground, (screws No. 77).....	17
6015 A	Needle Lever, steel.....	36
6015 B	Needle Lever, lynite.....	36
6035 A	Cloth Plate Guard, with cushion, for styles in Classes 7000, 7200, 7400, 7500, 7800, 8200, (screws No. 22730).....	36
6035 B	Cloth Plate Guard Cushion, felt, (screw No. 187 A).....	14
6037	Looper Connecting Rod, (nut, right thread, No. 18, nut, left thread, No. 269).....	21
‡ 6038	Looper Connecting Rod Ball Joint, left, for styles in Classes 7000, 7200, 7400, 8200, 8300.....	18
‡ 6038 B	Looper Connecting Rod Ball Joint, left, for styles in Classes 7500, 7800.....	18
‡ 6039	Looper Connecting Rod Ball Joint, right, (screws No. 97 A) Looper Connecting Rod Ball Stud Nut No. 18.	18
6042	Needle Lever Ball Clamp Bolt.....	12
6060	Renewable Bearing, ground, for left main shaft bearing of styles in Classes 7000, 7200, 7400, 7500, 7800, 8200.....	18
6090 A	Needle Lever Stud Sleeve, hardened and ground.....	25
6091	Needle Lever Nut, front, hexagonal.....	13
6091 A	Needle Lever Nut, rear, cylindrical.....	13
6092	Needle Lever Stud Sleeve Key.....	17
6093	Needle Lever Cone, hardened and ground, (set screws No. 88).....	13
6606	Feed Lift Cam, hardened and ground, for styles in Class 7800, (spot screw No. 96).....	18
6905 C	Feed Dog, for No. 5 gauge Styles 7200 A, 7200 C, (screw, $\frac{7}{16}$ inch long, No. 93).....	7
6958	Reciprocating Needle Rear Guard Frame Shaft Collar, (screw No. 88).....	13
7005 A-4 $\frac{1}{2}$	Feed Dog, for No. 4 $\frac{1}{2}$ gauge Style 7000 A.....	7
7005 A-6	Feed Dog, for Nos. 5 and 5 $\frac{1}{2}$ gauge Style 7000 A.....	7
7005 G-28	Feed Dog, for Nos. 28 and 30 gauge Style 7000 G.....	5

‡ See page 11.

LIST OF PARTS

Symbol to Order by	The figures in the last column refer only to the plates illustrating the parts and are not to be used in ordering.	Plate No.
7005 G-32	Feed Dog, for Nos. 32, 34 and 36 gauge Style 7000 G and No. 32 gauge Style 7400 N.....	5
7005 H-40	Feed Dog, for Nos. 40 and 44 gauge Style 7000 G and No. 40 gauge Style 7400 N.....	5
7005 H-48	Feed Dog, for No. 48 gauge Style 7000 G.....	5
7008 E-48	Feed Dog Screw, $\frac{7}{16}$ inch long, No. 93. Looper, front, for Nos. 40 and 44 gauge Style 7000 G, and No. 40 gauge Styles 7400 N, 7800 A, 7800 B, 7800 C, 7800 D.....	5
7009 E-30	Looper, back, for Nos. 28, 30 and 44 gauge Style 7000 G.....	4
7009 E-32	Looper, back, for No. 32 gauge Styles 7000 G, 7400 N, and No. 34 gauge Style 7000 G.....	4
7009 E-36	Looper, back, for No. 36 gauge Styles 7000 G, 7400 N.....	4
7009 E-40	Looper, back, for No. 40 gauge Styles 7000 G, 7400 N, 7800 A, 7800 B, 7800 C, 7800 D.....	4
7009 E-48	Looper, back, for No. 48 gauge Styles 7000 G, 7400 U, 7400 V, 7400 W, 7400 X, 7400 Y, 7400 AA, 7400 AF, 7400 AH, 7400 AJ, 7400 AK, 7400 AM, 7400 AN.....	4
7018 E-5	Looper Set Screw No. 73. Needle Holder, for No. 5 gauge styles in Classes 7000, 7200, 7400, 7500, 7800.....	19
7018 E-5 $\frac{1}{4}$	Needle Holder, for No. 5 $\frac{1}{4}$ gauge.....	19
7018 E-5 $\frac{1}{2}$	Needle Holder, for No. 5 $\frac{1}{2}$ gauge.....	19
7018 E-6	Needle Holder, for No. 6 gauge.....	19
7018 E-28	Needle Holder, for No. 28 gauge.....	19
7018 E-30	Needle Holder, for No. 30 gauge.....	19
7018 E-32	Needle Holder, for No. 32 gauge.....	19
7018 E-34	Needle Holder, for No. 34 gauge.....	19
7018 E-36	Needle Holder, for No. 36 gauge.....	19
7018 E-40	Needle Holder, for No. 40 gauge.....	19
7020 B-4 $\frac{1}{2}$	Needle Holder Spot Screw No. 89. Presser Foot, hinged, for No. 4 $\frac{1}{2}$ gauge Style 7000 A.....	8
7020 B-5	Presser Foot, hinged, for No. 5 gauge Style 7000 A.....	8
7020 B-5 $\frac{1}{2}$	Presser Foot, hinged, for No. 5 $\frac{1}{2}$ gauge Style 7000 A.....	8
7020 E-28	Presser Foot, hinged, for No. 28 gauge Style 7000 G.....	9
7020 E-30	Presser Foot, hinged, for No. 30 gauge Style 7000 G.....	9
7020 E-32	Presser Foot, hinged, for No. 32 gauge Style 7000 G.....	9
7020 E-34	Presser Foot, hinged, for No. 34 gauge Style 7000 G.....	9
7020 E-36	Presser Foot, hinged, for No. 36 gauge Style 7000 G.....	9
7020 E-40	Presser Foot, hinged, for No. 40 gauge Style 7000 G.....	9
7020 E-44	Presser Foot, hinged, for No. 44 gauge Style 7000 G.....	9
7020 E-48	Presser Foot, hinged, for No. 48 gauge Style 7000 G.....	9
7024 C-4 $\frac{1}{2}$	Presser Foot Clamp Screw No. 91. Throat Plate, for No. 4 $\frac{1}{2}$ gauge Style 7000 A.....	1
7024 C-5	Throat Plate, for No. 5 gauge Style 7000 A.....	1
7024 C-5 $\frac{1}{2}$	Throat Plate, for No. 5 $\frac{1}{2}$ gauge Style 7000 A.....	1

LIST OF PARTS

Symbol to Order by	The figures in the last column refer only to the plates illustrating the parts and are not to be used in ordering.	Plate No.
7024 G-28	Throat Plate, for No. 28 gauge Style 7000 G	2
7024 G-30	Throat Plate, for No. 30 gauge Style 7000 G	2
7024 H-32	Throat Plate, for No. 32 gauge Styles 7000 G, 7400 N	2
7024 H-34	Throat Plate, for No. 34 gauge Style 7000 G	2
7024 H-36	Throat Plate, for No. 36 gauge Styles 7000 G, 7400 N	2
7024 H-40	Throat Plate, for No. 40 gauge Styles 7000 G, 7400 N	2
7024 H-44	Throat Plate, for No. 44 gauge Style 7000 G	2
7024 H-48	Throat Plate, for No. 48 gauge Style 7000 G	2
	Throat Plate Screws No. 87.	
7040-6	Needle Holder Thread Guide, for Nos. 5 to 32 gauges, inclu- sive, on styles in Classes 7000, 7200, 7400, 7500, 7800, and for Nos. 5 $\frac{1}{4}$ and 5 $\frac{1}{2}$ gauge styles in Classes 8200, 8300	19
7040-33	Needle Holder Thread Guide, for Nos. 33 to 40 gauges, inclu- sive, on styles in Classes 7000, 7800	19
	Needle Holder Thread Guide Screw No. 187 A.	
7201 T	Cloth Plate, for Styles 7200 T, 8200 V, (screws, countersunk head No. 80, fillister head, No. 93 A)	39
7205 A	Feed Dog, for Nos. 1, 2, 3, and 4 gauge Styles 7200 A, 7200 C, 7200 T, 8200 A, 8200 C, 8200 E, 8200 O, 8200 V, Nos. 3 and 4 gauge Styles 7500 X, 8200 W, and Nos. 00, 0, 1, 2, 3, and 4 gauge Style 8200 M (screw, $\frac{7}{16}$ inch long, No. 93)	7
7209-1	Looper, back, for No. 1 gauge styles in Classes 7200, 7400, (set screw No. 73)	4
7224 A-1	Throat Plate, for No. 1 gauge Styles 7200 A, 7200 C, 7200 T	2
7224 A-2	Throat Plate, for No. 2 gauge Styles 7200 A, 7200 C, 7200 T	2
7224 A-3	Throat Plate, for No. 3 gauge Styles 7200 A, 7200 C, 7200 T, 7500 X	2
7224 A-4	Throat Plate, for No. 4 gauge Styles 7200 A, 7200 C, 7200 T, 7500 X	2
	Throat Plate Screws No. 87.	
7225	Reciprocating Needle Rear Guard, hardened, for styles in Classes 7000, 7200, 7400, 7500, (screw No. 90)	10
7240	Needle Guard, for presser feet Nos. 65 QH and 8220, all gauges, (screw No. 91 A)	10
7401 A	Cloth Plate, for styles in Class 7400 having annular take-up, (screw, countersunk head No. 80, fillister head No. 93 A)	39
7401 R	Cloth Plate, for Style 8200 S, having double disc take-up, (screws, countersunk head No. 80, fillister head No. 93 A)	39
7402	Cloth Plate Slide, right, for Style 7500 T (thumbscrew No. 25 T)	34
7404 A	Cast-off, for styles having annular take-up (clamp screw No. 77)	20
7405-1	Feed Dog, for Nos. 1, 2, 3, and 4 gauge Styles 7400 A, 7400 N	5
7405-4 $\frac{1}{2}$	Feed Dog, for No. 4 $\frac{1}{2}$ gauge Styles 7400 A, 7400 N	7
7405 B-4	Feed Dog, for No. 4 gauge Styles 7400 B, 7500 B	7

LIST OF PARTS

Symbol to Order by	The figures in the last column refer only to the plates illustrating the parts and are not to be used in ordering.	Plate No.
7405 B-5	Feed Dog, for Nos. 4½ and 5 gauge Style 7400 B, and No. 5 gauge Style 7400 N.....	7
7405 B-6	Feed Dog, for Nos. 5½ and 6 gauge Style 7400 B and No. 5½ gauge Style 7400 N.....	7
7405 S-48	Feed Dog, for No. 48 gauge Styles 7400 V, 7400 W, 7400 X, 7400 Y, 7400 AA, 7400 AF, 7400 AH, 7400 AJ, 7400 AK, 7400 AM, 7400 AN.....	6
7405 T-48	Feed Dog, for No. 48 gauge Style 7400 U.....	5
7405 AG-5	Feed Dog, for No. 5 gauge Style 7400 AG.....	6
7408-48	Feed Dog Screw, 7/16 inch long, No. 93.	
7408-48	Looper, front, for No. 48 gauge styles in Class 7800.....	4
7408 X-48	Looper, front, for No. 48 gauge styles in Class 7400 (set screw No. 73).....	—
7420 N-4	Presser Foot, hinged, for No. 4 gauge Style 7400 N.....	10
7420 N-4½	Presser Foot, hinged, for No. 4½ gauge Style 7400 N.....	10
7420 N-5	Presser Foot, hinged, for No. 5 gauge Style 7400 N.....	10
7420 N-5½	Presser Foot, hinged, for No. 5½ gauge Style 7400 N.....	10
7420 N-6	Presser Foot, hinged, for No. 6 gauge Style 7400 N.....	10
7420 N-32	Presser Foot, hinged, for No. 32 gauge Style 7400 N.....	10
7420 N-36	Presser Foot, hinged, for No. 36 gauge Style 7400 N.....	10
7420 N-40	Presser Foot, hinged, for No. 40 gauge Style 7400 N.....	10
7420 AG-4½	Presser Foot, hinged, for No. 4½ gauge Style 7400 AG.....	8
7420 AG-5	Presser Foot, hinged, for No. 5 gauge Style 7400 AG.....	8
	Presser Foot Clamp Screw No. 91.	
7421	Eccentric Pulley, throw .461 inch, for styles having double disc take-up in Classes 7400, 8200, 8300.....	26
7421 A	Eccentric Pulley, throw .461 inch, for styles having annular take-up in Class 7400 (screws No. 22597).....	26
7422 A	Main Shaft, for styles having annular take-up.....	35
7423 A	Looper Thread Annular Take-up (spot screw No. 89).....	20
7424-1	Throat Plate, for No. 1 gauge Style 7400 A.....	1
7424-2	Throat Plate, for No. 2 gauge Style 7400 A.....	1
7424-3	Throat Plate, for No. 3 gauge Style 7400 A.....	1
7424-4	Throat Plate, for No. 4 gauge Styles 7400 A, 7400 N.....	1
7424-4½	Throat Plate, for No. 4½ gauge Styles 7400 A, 7400 N.....	1
7424 B-4	Throat Plate, for No. 4 gauge Style 7400 B.....	3
7424 B-4½	Throat Plate, for No. 4½ gauge Style 7400 B.....	3
7424 B-5	Throat Plate, for No. 5 gauge Styles 7400 B, 7400 N.....	3
7424 B-5½	Throat Plate, for No. 5½ gauge Styles 7400 B, 7400 N.....	3
7424 B-6	Throat Plate, for No. 6 gauge Style 7400 B.....	3
7424 S-48	Throat Plate, for No. 48 gauge Styles 7400 V, 7400 W, 7400 X, 7400 Y, 7400 AA, 7400 AF, 7400 AH, 7400 AJ, 7400 AK, 7400 AM, 7400 AN.....	3
7424 T-48	Throat Plate, for No. 48 gauge Style 7400 U.....	2
7424 AG-5	Throat Plate, for No. 5 gauge Style 7400 AG.....	3
	Throat Plate Screws No. 87.	

LIST OF PARTS

Symbol to Order by	The figures in the last column refer only to the plates illustrating the parts and are not to be used in ordering.	Plate No.
7425 A	Feed Bar Needle Rear Guard, for Styles 7400 A, 7400 B, having annular take-up (screw No. 90).....	10
7426 B	Feed Dog, for No. 3 gauge Style 7500 T (screw $\frac{7}{16}$ inch long, No. 93).....	6
7427 G-3	Presser Foot, hinged, for No. 3 gauge Style 7500 T.....	10
7427 T-48	Presser Foot, hinged, for No. 48 gauge Style 7400 U (clamp screw No. 91).....	35
7428 B-3	Throat Plate, for No. 3 gauge Style 7500 T (screws No. 87)...	3
7445 A	Looper Rocker Frame, detachable cone design, for styles having annular take-up.....	23
7446 A	Looper Rock Shaft, for styles having annular take-up.....	21
7448 A	Needle Thread Tension Eyelet, sheet metal, for styles having annular take-up.....	19
7458 A	Looper Thread Take-up Eyelet, for styles having annular take-up.....	20
7462 D	Renewable Bearing, right, for main shaft in styles having annular take-up (screw No. 22590).....	35
7463 A	Main Shaft Sleeve, for cast-off, in styles having annular take-up	24
7484 A	Feed Rocker Arm, for styles having annular take-up (clamp screws No. 93).....	35
7499 A	Main Shaft Counterweight, for styles having annular take-up (screws No. 77).....	35
7505	Feed Dog, for Nos. 4 $\frac{1}{2}$, 5 and 6 gauge Style 7500 B; also for Nos. 4 $\frac{1}{2}$ and 5 gauge Style 7500 X.....	6
7505 C	Feed Dog, for No. 5 $\frac{1}{2}$ gauge Style 7500 B.....	5
7505 M-4 $\frac{1}{2}$	Feed Dog, for No. 4 $\frac{1}{2}$ gauge Style 7400 AG.....	7
	Feed Dog Screw, $\frac{7}{16}$ inch long, No. 93.	
7524 B-4	Throat Plate, for No. 4 gauge Style 7500 B.....	1
7524 B-4 $\frac{1}{2}$	Throat Plate, for No. 4 $\frac{1}{2}$ gauge Styles 7500 B, 7500 X.....	1
7524 B-5	Throat Plate, for No. 5 gauge Styles 7500 B, 7500 X.....	1
7524 B-5 $\frac{1}{2}$	Throat Plate, for No. 5 $\frac{1}{2}$ gauge Style 7500 B.....	1
7524 B-6	Throat Plate, for No. 6 gauge Style 7500 B.....	1
7524 C-4 $\frac{1}{2}$	Throat Plate, for No. 4 $\frac{1}{2}$ gauge Styles 7200 A, 7200 C.....	1
7524 C-5	Throat Plate, for No. 5 gauge Styles 7200 A, 7200 C.....	1
	Throat Plate Screws No. 87.	
7526	Feed Dog, for No. 40 gauge Styles 7800 A, 7800 B, 7800 C, 7800 D, (screw, $\frac{9}{32}$ inch long, No. 93 A).....	6
7528 B-40	Throat Plate, for No. 40 gauge Styles 7800 A, 7800 B, 7800 C, 7800 D, (screw No. 87).....	3
7528 H-4 $\frac{1}{2}$	Throat Plate, for No. 4 $\frac{1}{2}$ gauge Style 7400 AG, (screws No. 87)	3
7638 A	Looper Thread Deflecting Wire, (screw No. 93).....	24
7656	Looper Thread Take-up Eyelet, for No. 48 gauge styles having double disc take-up, (adjusting screw No. 97).....	20
7801	Cloth Plate, for styles having double disc take-up in Class 7800; also Styles 7400 AG, 7400 AM, 7400 AN, (screws, countersunk head, No. 80, fillister head, No. 93 A).....	39

LIST OF PARTS

Symbol to Order by	The figures in the last column refer only to the plates illustrating the parts and are not to be used in ordering.	Plate No.
7805 A-5	Feed Dog, for No. 5 gauge Styles 7800 A, 7800 B, 7800 C, 7800 D.....	6
7805 A-5½	Feed Dog, for No. 5½ gauge Styles 7800 A, 7800 B, 7800 C, 7800 D.....	6
7805 A-48	Feed Dog, for No. 48 gauge Styles 7800 A, 7800 B, 7800 C, 7800 D.....	6
7805 F	Feed Dog, for No. 4½ gauge Style 7800 F..... Feed Dog Screw, ⅞ inch long, No. 93 A.	6
7809-32	Looper, back, for No. 32 gauge styles in Class 7800.....	5
7809-48	Looper, back, for No. 48 gauge styles in Class 7800..... Looper Set Screw No. 73.	5
7820 C-40	Presser Foot, for No. 40 gauge Styles 7800 A, 7800 B, 7800 C, 7800 D, (set screws No. 88).....	9
7822	Main Shaft, hardened and ground, standard diameter .530 inch, for styles in Class 7800; also Styles 7400 AG, 7400 AM, 7400 AN.....	35
7822-531	Main Shaft, standard diameter plus .001 inch.....	—
7822-533	Main Shaft, standard diameter plus .003 inch.....	—
7822-536	Main Shaft, standard diameter plus .006 inch.....	—
7822-539	Main Shaft, standard diameter plus .009 inch.....	—
7822-542	Main Shaft, standard diameter plus .012 inch.....	—
7824 A-5	Throat Plate, for No. 5 gauge Styles 7800 A, 7800 B, 7800 C, 7800 D.....	2
7824 A-5½	Throat Plate, for No. 5½ gauge Styles 7800 A, 7800 B, 7800 C, 7800 D.....	2
7824 A-48	Throat Plate, for No. 48 gauge Styles 7800 A, 7800 B, 7800 C, 7800 D.....	2
7824 F-4½	Throat Plate, for No. 4½ gauge Style 7800 F..... Throat Plate Screws No. 87.	3
7825 A	Feed Bar Needle Rear Guard, for Nos. 5, 5½, 6, 32 and 40 gauge styles in Class 7800.....	10
7825 B	Feed Bar Needle Rear Guard, for No. 48 gauge styles in Class 7800.....	10
7825 D	Feed Bar Needle Rear Guard, for No. 4½ gauge Style 7800 F Feed Bar Needle Rear Guard Screw No. 94.	10
7827 A-5	Presser Foot, hinged, for No. 5 gauge Styles 7800 A, 7800 B, 7800 C, 7800 D.....	8
7827 A-5½	Presser Foot, hinged, for No. 5½ gauge Styles 7800 A, 7800 B, 7800 C, 7800 D.....	8
7827 A-6	Presser Foot, hinged, for No. 6 gauge Styles 7800 A, 7800 B, 7800 C, 7800 D.....	8
7827 A-32	Presser Foot, hinged, for No. 32 gauge Styles 7800 A, 7800 C	8
7827 A-48	Presser Foot, hinged, for No. 48 gauge Styles 7800 B, 7800 D	8
7827 B-4½	Presser Foot, hinged, for No. 4½ gauge Style 7800 F, (hinge screw No. 86 X).....	9

LIST OF PARTS

Symbol to Order by	The figures in the last column refer only to the plates illustrating the parts and are not to be used in ordering.	Plate No.
7827 C-48	Presser Foot, rigid bottom, for No. 48 gauge Styles 7800 A, 7800 C.	9
	Presser Foot Set Screws No. 88.	
7917	Needle Bar, hardened and ground, standard diameter .257 inch, for No. 48 gauge styles in Classes 7000, 7400, 7800, (set screws, headless, No. 88, fillister head, No. 88 A)	21
7918-48	Needle Holder, for No. 48 gauge styles in Classes 7000, 7400, 7800, (spot screw No. 89)	19
7933-48	Needle Stop Plate, for No. 48 gauge styles in Classes 7000, 7400, 7800, (screws No. 605 A)	19
7947	Feed Crank Link Nut.	13
8020-48	Presser Foot, hinged, for No. 48 gauge Styles 7400 V, 7400 W, 7400 X, 7400 Y, 7400 AA, 7400 AF, 7400 AH, 7400 AJ, 7400 AK, 7400 AM, 7400 AN, (clamp screw No. 91)	9
8205	Feed Dog, for No. 5 gauge Style 8200 E, (screw, $\frac{7}{16}$ inch long, No. 93)	6
8219-1	Needle Guide Foot, with yielding spring edge guide, for No. 1 gauge Style 8200 T.	8
8219-2	Needle Guide Foot, for No. 2 gauge.	8
8219-3	Needle Guide Foot, for No. 3 gauge.	8
8219-4	Needle Guide Foot, for No. 4 gauge.	8
8219-4 $\frac{1}{4}$	Needle Guide Foot, for No. 4 $\frac{1}{4}$ gauge.	8
8219-4 $\frac{1}{2}$	Needle Guide Foot, for No. 4 $\frac{1}{2}$ gauge.	8
8219-5	Needle Guide Foot, for No. 5 gauge.	8
8219-5 $\frac{1}{4}$	Needle Guide Foot, for No. 5 $\frac{1}{4}$ gauge.	8
8219-5 $\frac{1}{2}$	Needle Guide Foot, for No. 5 $\frac{1}{2}$ gauge.	8
	Needle Guide Foot Clamp Screw No. 91.	
8220-1	Presser Foot, for Nos. 1 and 2 gauge Style 8200 C.	8
8220-3	Presser Foot, for Nos. 3 and 4 gauge Style 8200 C.	8
8220-4 $\frac{1}{2}$	Presser Foot, for Nos. 4 $\frac{1}{4}$ and 4 $\frac{1}{2}$ gauge Style 8200 C.	8
8220 M-1	Presser Foot, rigid bottom, adjustable guide on left hand side, for No. 1 gauge Style 8200 M.	8
8220 M-2	Presser Foot, for No. 2 gauge Style 8200 M.	8
8220 M-3	Presser Foot, for No. 3 gauge Style 8200 M.	8
8220 M-4	Presser Foot, for No. 4 gauge Style 8200 M.	8
8220 M-4 $\frac{1}{4}$	Presser Foot, for No. 4 $\frac{1}{4}$ gauge Style 8200 M.	8
8220 M-4 $\frac{1}{2}$	Presser Foot, for No. 4 $\frac{1}{2}$ gauge Style 8200 M.	8
8220 M-5	Presser Foot, for No. 5 gauge Style 8200 M.	8
8220 O-1	Presser Foot, rigid bottom, adjustable guide on right hand side, for No. 1 gauge Style 8200 O.	8
8220 O-2	Presser Foot, for No. 2 gauge Style 8200 O.	8
8220 O-3	Presser Foot, for No. 3 gauge Style 8200 O.	8
8220 O-4	Presser Foot, for No. 4 gauge Style 8200 O.	8
8220 O-4 $\frac{1}{4}$	Presser Foot, for No. 4 $\frac{1}{4}$ gauge Style 8200 O.	8
8220 O-4 $\frac{1}{2}$	Presser Foot, for No. 4 $\frac{1}{2}$ gauge Style 8200 O.	8
8220 S-1	Presser Foot, hinged, for No. 1 gauge Style 8200 S.	8

LIST OF PARTS

Symbol to Order by	The figures in the last column refer only to the plates illustrating the parts and are not to be used in ordering.	Plate No.
8220 S-2	Presser Foot, for No. 2 gauge Style 8200 S.....	8
8220 S-3	Presser Foot, for No. 3 gauge Style 8200 S.....	8
8220 W-3	Presser Foot, rigid bottom, for No. 3 gauge, Style 8200 W..	8
8220 W-4	Presser Foot, for No. 4 gauge Style 8200 W.....	8
	Presser Foot Clamp Screw No. 91.	
8224-00	Throat Plate, for No. 00 gauge Style 8200 M.....	1
8224-0	Throat Plate, for No. 0 gauge Style 8200 M.....	1
8224-1	Throat Plate, for No. 1 gauge Styles 8200 C, 8200 E, 8200 M, 8200 O, 8200 V.....	1
8224-2	Throat Plate, for No. 2 gauge Styles 8200 A, 8200 C, 8200 E, 8200 M, 8200 O, 8200 V.....	1
8224-3	Throat Plate, for No. 3 gauge Styles 8200 A, 8200C, 8200 E, 8200 M, 8200 O, 8200 V, 8200 W.....	1
8224-4	Throat Plate, for No. 4 gauge Styles 8200 A, 8200 C, 8200 E, 8200 M, 8200 O, 8200 V, 8200 W.....	1
8224-4 $\frac{1}{4}$	Throat Plate, for No. 4 $\frac{1}{4}$ gauge Styles 8200 A, 8200 C, 8200 E, 8200 M, 8200 O.....	1
8224-4 $\frac{1}{2}$	Throat Plate, for No. 4 $\frac{1}{2}$ gauge Styles 8200 A, 8200 C, 8200 E, 8200 M, 8200 O.....	1
8224-5	Throat Plate, for No. 5 gauge, Style 8200 E.....	1
	Throat Plate Screws No. 87.	
8225-A	Reciprocating Needle Rear Guard, hardened, for styles in Class 8200, (screw No. 90).....	10
8227 P-00	Presser Foot, rigid bottom, with guide on left hand side, for No. 00 gauge Style 8200 M.....	9
8227 Q-0	Presser Foot, rigid bottom, with guide on right hand side, for No. 0 gauge Style 8200 O, (clamp screw No. 91).....	9
8235	Spring Guide, yielding, for needle guide foot on Style 8200 T, (screw No. 91 A, adjusting screw No. 28 C).....	10
8301 M	Cloth Plate, for Style 8300 K, (screws, countersunk head, No. 80, fillister head, No. 93 A).....	39
8305 L	Main Feed Dog, for No. 4 $\frac{1}{2}$ gauge Style 8300 K.....	6
8305 N	Main Feed Dog, for No. 4 gauge Style 8300 K.....	6
8305 S	Main Feed Dog, for No. 3 gauge Style 8300 K.....	6
	Main Feed Dog Screw, $\frac{9}{32}$ inch long No. 22593.	
8309 C-4 $\frac{1}{2}$	Looper, back, for No. 4 $\frac{1}{2}$ gauge Style 8300 K, (set screw No. 73).....	4
8318-5 $\frac{1}{4}$	Needle Holder, for No. 5 $\frac{1}{4}$ gauge styles in Class 8200.....	19
8318-5 $\frac{1}{2}$	Needle Holder, for No. 5 $\frac{1}{2}$ gauge styles in Class 8200 (spot screw No. 89).....	19
8324 L-4	Throat Plate, for No. 4 gauge Style 8300 K (screws No. 87)	3
8324 L-4 $\frac{1}{2}$	Throat Plate, for No. 4 $\frac{1}{2}$ gauge Style 8300 K, (screws No. 87)	3
8325	Feed Bar Needle Rear Guard, hardened, for Style 8300 K, (screw No. 22596).....	10
8326	Differential Feed Dog, for No. 4 $\frac{1}{2}$ gauge Style 8300 K (screw No. 22585).....	6

LIST OF PARTS

Symbol to Order by	The figures in the last column refer only to the plates illustrating the parts and are not to be used in ordering.	Plate No.
8326 A	Differential Feed Dog, for No. 4 gauge Style 8300 K, (screw No. 22585).....	6
8344	Stripper Blade, for Style 8300 K, (screws No. 187 A).....	10
8356 A	Feed Rocker, for Style 8300 K, (screws No. 88).....	23
8359	Needle Rear Guard Fork, for Style 8300 K, (screw No. 22596)	16
8360	Differential Feed Bar Link, for Style 8300 K.....	16
8361	Differential Feed Bar Link Pin, rear, (screw No. 22733)....	16
8362 A	Differential Feed Controlling Shaft Arm, for Style 8300 K, (screw No. 88).....	16
8362 B	Differential Feed Controlling Shaft Arm Link, (stud No. 86).	16
8362 C	Differential Feed Controlling Lever.....	16
8362 D	Differential Feed Controlling Lever Pivot Pin, (set screw No. 88).....	16
8363	Differential Feed Controlling Lever Link, (stud No. 86)....	16
8365 A	Differential Feed Controlling Shaft, 10½ inches long.....	21
8366 A	Differential Feed Controlling Shaft Bearing, left.....	16
8367 A	Differential Feed Controlling Shaft Bearing, right, (screws No. 93).....	16
8368 A	Differential Feed Controlling Shaft Spring.....	14
8368 B	Differential Feed Controlling Shaft Spring Adjusting Clamp, (screw No. 93).....	16
8369 A	Differential Feed Controlling Shaft Operating Lever, (stud No. 4937).....	16
8370 A	Differential Feed Indicator, (clamp screw No. 93).....	16
8371 A	Differential Feed Index, (screws No. 98 A).....	16
8372	Differential Feed Indicator Stop, (stop screw No. 25 CC)...	16
8372 A	Differential Feed Indicator Stop Screw Washer.....	14
8373	Cloth Plate Guard, with cushion, for Style 8300 K, (screws No. 22730).....	36
8374	Feed Rocker Segment Cover, for Style 8300 K, (screws No. 22561).....	27
8501	Cloth Plate, for styles with double disc take-up in Classes 7000, 7400, 7500; also Styles 7200 A, 7200 C, 7200 S, 8200 A, 8200 C, 8200 E, 8200 M, 8200 N, 8200 O, 8200 T, 8200 V, 8200 W, (screws, countersunk head, No. 80, fillister head, No. 93 A).....	39
8559	Reciprocating Needle Rear Guard Holder, for styles in Classes 7000, 7200, 7400, 7500, 8200, (screws No. 90).....	10
8560	Reciprocating Needle Rear Guard Frame, includes shoes, (set screws No. 88, adjusting screw No. 294).....	24
8561	Reciprocating Needle Rear Guard Frame Eccentric Bearing, (screws No. 22768).....	24
8562	Feed Bar Prong Felt, for styles with reciprocating needle rear guard.....	17
8563	Reciprocating Needle Rear Guard Frame Felt.....	17

LIST OF PARTS

Symbol to Order by	The figures in the last column refer only to the plates illustrating the parts and are not to be used in ordering.	Plate No.
8564	Reciprocating Needle Rear Guard Frame Shaft, 2 $\frac{1}{2}$ inches long, hardened and ground, size .257 inch	21
8565	Reciprocating Needle Rear Guard Frame Rocker	23
8566 B	Feed Rocker, non-floating design, for styles having double disc take-up in Classes 7000, 7200, 7400, 7500	23
8567	Feed Bar Prong, for styles in Classes 7000, 7200, 7400, 7500, 8200, (screws No. 94)	27
8645	Quilting Guide, right, adjustable, for Styles 7400 AH, 7400 AJ, 7400 AN	35
8646	Quilting Guide, left, adjustable, (screw No. 88)	35
8647	Quilting Guide Support, (screw No. 88)	35
8648	Quilting Guide Assembly; one each Nos. 8645, 8646, 8647 and three No. 88	—
9140	Adjustable Guide, for presser foot No. 8220 M, all gauges, (screw No. 91 A)	10
9141	Adjustable Guide, for presser foot No. 8220 O, all gauges, (screw No. 91 A)	10
9271	Collar, for knee press shaft, (screw No. 98)	24
9420 C-4	Presser Foot, rigid bottom, for No. 4 gauge Style 8300 K, (clamp screw No. 91)	10
9420 C-4 $\frac{1}{2}$	Presser Foot, for No. 4 $\frac{1}{2}$ gauge Style 8300 K, (clamp screw No. 91)	10
9675	Stay Cutter Knife Returning Spring Stud, for Styles 7200 T, 8200 V	12
9932	Feed Bar Shoe, hardened and ground, for styles in Classes 7000, 7200, 7400, 7500, 7800, (screw No. 94)	27
10334 A	Needle Bar Thread Eyelet, for styles in Classes 7000, 7400, 7500, 7800, 8300; also Styles 7200 S, 8200 S, (screw No. 22768)	20
10335	Frame Tension Thread Guide	20
11261 A	Looper Thread Tension Post, upper, 1 $\frac{7}{8}$ inches long	18
11261 B	Looper Thread Tension Post Ferrule	13
11262	Tension Thread Eyelet, 1 $\frac{1}{8}$ $\frac{5}{8}$ inches long	19
11638 M	Needle Lever Cone Adjusting Nut	13
11684 AA	Street Elbow, for oil cup, on styles having annular take-up	27
11721	Eccentric Pulley, throw .588 inch, for styles having double disc take-up in Classes 7500, 7800, (screws No. 22597)	26
12873	Renewable Bearing, ground, $\frac{2}{3}$ $\frac{5}{2}$ inch long, for needle bar of styles in Classes 7000, 7200, 7400, 7500, 8200, 8300; also upper renewable bearing for needle bar on styles in Class 7800	13
12873 A	Renewable Bearing, lower, ground, $\frac{5}{8}$ inch long, for needle bar of styles in Class 7800, (screw No. 22569)	13
12964 C	Needle Lever Link Pin Ball	14
12987 A	Looper Rocker Cone Adjusting Nut	13
13148-12	Tension Post Elongating Stud, plain stem, $\frac{3}{8}$ inch increment	18

LIST OF PARTS

Symbol to Order by	The figures in the last column refer only to the plates illustrating the parts and are not to be used in ordering.	Plate No.
14544	Feed Bar Shaft, $3\frac{9}{16}$ inches long, hardened and ground, for Style 8300 K.....	17
15151	Needle Thread Pull-off and Take-up Wire, for styles in Class 7800, (screw No. 87 U).....	19
15430 C	Needle Lever Connecting Rod Nut, left thread.....	13
15430 D	Needle Lever Connecting Rod Nut, right thread; also for No. 21693 J.....	13
15430 L	Needle Lever Connecting Rod Felt.....	21
† 15430 M	Needle Lever Connecting Rod Lower Bearing, wick feed oiling, (screws No. 22587).....	26
15447 E	Feed Bar, for Style 8300 K, (screws No. 88).....	23
15447 F	Feed Bar Shoe, hardened and ground, for Style 8300 K, (screw No. 22596).....	17
15447 G	Feed Bar Prong and Sponge, for Style 8300 K, (screws No. 94)	27
15447 K	Differential Feed Bar Guide Plate Holder, for Style 8300 K, (screw, front, No. 22596, rear No. 93).....	16
15447 L	Differential Feed Bar Guide Plate, adjustable, (screws No. 90)	17
15465 F	Looper Rocker Cone, hardened and ground, (screws No. 88, adjusting nut No. 12987 A).....	13
15745 B	Looper Rocker Cone Stud, hardened and ground, $\frac{5}{16}$ inch diameter.....	12
16195 B	Renewable Bearing, right, for main shaft, in styles having double disc take-up of Classes 7000, 7200, 7400, 7500, 7800, 8200.....	25
17142	Feed Bar, for styles in Class 7400 having annular take-up...	23
17142 A	Needle Rear Guard Holder Base, for styles in Class 7400 having annular take-up, (screw, rear No. 25 CC, front, No. 22528).....	16
21104 A	Thread Stand Base; also for No. 21173 C, (screw No. 22509)	38
21104 B-11	Thread Stand Rod, 11 inches long; also for No. 21173 C....	35
21104 B-20	Upper Tape Reel Support Rod, 20 inches long, (set screw No. 22509).....	35
21106 B	Spool Cap Thread Unwinder.....	28
21113 A	Thread Stand Wire Extension, 6 inches long, (set screw, square head, 24 threads to inch, No. 22632 F-24, headless, No. 22813, obsolete).....	21
21113 B	Thread Stand Wire Coupling, (screws No. 88).....	13
21130 A-4	Thread Stand Seat, 4 spools, (set screw No. 69 FD).....	38
21145	Cone, wood, for thread stands.....	27
21150	Upper Tape Reel Assembly, for Styles 7000 G, 7400 N, using tape from $\frac{1}{2}$ inch to $1\frac{3}{16}$ inches wide, one each Nos. 25 S, 88, 94, 430, 431 A, 432, 433, 434, 21161 C, 21161 D, 21163, 21164 and two each Nos. 98, 21157.....	39
21157	Upper Tape Reel Disc, 8 inches diameter.....	39
21161 C	Upper Tape Reel Frame, (set screws No. 98).....	39
21161 D	Upper Tape Reel Strip Guide, (set screw No. 88).....	39

† See page 11.

LIST OF PARTS

Symbol to Order by	The figures in the last column refer only to the plates illustrating the parts and are not to be used in ordering.	Plate No.
21163	Upper Tape Reel Rod, $4\frac{5}{16}$ inches long, (set screw No. 25 S) . .	21
21164	Upper Tape Reel Post, (set screw No. 22508)	21
21168 A	Tape Reel Axle Base, (nut No. 18)	—
21168 B	Tape Reel Stand	—
21168 G	Tape Reel Assembly, for Style 7500 T, using binding strip from $1\frac{1}{2}$ to $2\frac{3}{8}$ inches wide, one each Nos. 20, 430 B, 431 A, 432, 433, 434, 21168 A, 21168 B and two each Nos. 18, 21157	39
21170	Tape Guide, for Nos. 28 to 40 gauge, inclusive, styles in Classes 7000, 7400	28
21170 A	Tape Guide for Nos. 32 to 48 gauge, inclusive, styles in Classes 7000, 7400, (screw No. 93 A)	28
21171	Spool Holder Assembly, for Style 8200 E, one each Nos. 25 T, 110-3, 21172, 21172 A, 21172 B, 21172 C, 21172 D, and two No. 90	38
21172	Spool Holder Post, for Style 8200 E, (screw No. 94)	—
21172 A	Spool Holder Stay Guide, (set screw No. 90)	—
21172 B	Spool Holder Stay Guide Support, adjustable, (set screw No. 90)	—
21172 C	Spool Holder Axle, (thumbscrew No. 25 T)	—
21172 D	Spool Holder Axle Floating Collar	—
21173 A	Upper Tape Reel Support Vertical Rod Connection, (screws No. 22508)	38
21173 B	Upper Tape Reel Support Post Socket, (screws No. 22508)	38
21173 C	Upper Tape Reel Support Assembly, for Styles 7000 G, 7400 N; also for No. 21171; one each Nos. 21104 A, 21104 B-11, 21104 B-20, 21173 A, 21173 B, two No. 96 and four No. 22508	38
21176 A	Lower Tape Reel Assembly, for Styles 7400 U, 7400 V, 7400 W, 7400 X, 7400 Y, 7400 AA, 7400 AF, 7400 AG, 7400 AH, 7400 AM, 7400 AN, 7500 X; one each Nos. 110-3, 201 A, 201 C, 21385 B and two No. 21178	39
21178	Lower Tape Reel Disc, 8 inches diameter	39
21182 K	Strip Tension Plate, outer, for Style 7400 U	—
21182 L	Strip Tension Plate, inner	—
21182 N	Strip Tension Assembly, for Style 7400 U	34
21182 P	Strip Tension Plate Base	—
21182 T	Elastic Tension Assembly, for Style 7400 AG	34
21201	Screw Driver, round steel, diameter $\frac{5}{32}$ inch, length overall $7\frac{5}{8}$ inches	37
21202	Screw Driver, round steel, diameter $\frac{7}{32}$ inch, length overall 10 inches	37
21203	Screw Driver, round steel, diameter $\frac{7}{32}$ inch, length overall 13 inches	37
21204	Screw Driver, round steel, diameter $\frac{1}{4}$ inch, length overall 15 inches	37

LIST OF PARTS

Symbol to Order by	The figures in the last column refer only to the plates illustrating the parts and are not to be used in ordering.	Plate No.
21205	Screw Driver, octagon steel, diameter $\frac{5}{16}$ inch, length overall $14\frac{1}{2}$ inches	37
21206	Screw Driver Wrench	37
21207	Screw Driver, round steel, diameter $\frac{5}{64}$ inch, length overall $2\frac{1}{2}$ inches	28
21208	Screw Driver Set, three blades	37
21210	Looper Collar, .040 inch thick	14
21210 A	Looper Collar, .020 inch thick	—
21211	Looper Collar, .054 inch thick	14
21225- $\frac{7}{32}$	Looper Adjusting Gauge, $\frac{7}{32}$ inch measurement	14
21225- $\frac{1}{4}$	Looper Adjusting Gauge, $\frac{1}{4}$ inch measurement	14
21225 A	Looper Gauge, universal adjustment	14
21261	Leather Belt, flat, 1 inch wide, 63 inches long, including malleable iron belt fastener No. 21350	—
21262	Leather Belt, round, $\frac{9}{32}$ inch diameter, 44 inches long, including wire belt hook No. 21351	—
21350	Malleable Iron Belt Fastener, for 1 inch flat belt	15
21351	Wire Belt Hook, for $\frac{9}{32}$ inch round belt	15
21355	Chair Leg Extension, 4 inches long	27
21355 A	Chair Leg Extension, 6 inches long	27
21364	Hinge Pin, detachable, for tray No. 21377	24
<input type="checkbox"/> 21368	Washer, $\frac{1}{4}$ inch, for flat head stove bolts	—
21369-3	Clamping Bolt, includes wing nut and washer, for tray No. 21377 C	28
21371 B	Table Top, 48 inches long, $16\frac{1}{8}$ inches wide, $1\frac{3}{4}$ inches thick	—
21371 M	Individual Power Table, excludes pulley guard, pitman, belting, transmitter and electric motor, includes treadle	—
21371 T-2	Individual Power Table, includes transmitter, treadle pulley guard, pitman, belting, $\frac{1}{2}$ H. P. 115 Volt, D. C. electric motor. Note: Style of machine must be specified	—
21371 T-4	Individual Power Table, equipped with $\frac{1}{2}$ H. P. 230 Volt, D. C. electric motor	—
21371 T-6	Individual Power Table, equipped with $\frac{1}{2}$ H. P. 110 Volt, single phase, 60 cycle, A. C. electric motor	—
21371 T-8	Individual Power Table, equipped with $\frac{1}{2}$ H. P. 220 Volt, single phase, 60 cycle, A. C. electric motor	—
21371 T-16	Individual Power Table, equipped with $\frac{1}{2}$ H. P. 220 Volt, three phase, 60 cycle, A. C. electric motor	—
21375 A	Pulley Guard	38
21377	Tray or Work Support, wood, closed bottom, front section hinged, $3\frac{7}{8}$ inches high	38
21377 C	Tray or Work Support, wood, no bottom, hinged	38
21377 K	Tray or Work Support, wood, no bottom, hinged, $4\frac{1}{2}$ inches high, for Styles in Class 7400 equipped with puller	—
21384 A	Leather Plug for cloth plate screw holes	—

See page 11.

LIST OF PARTS

Symbol to Order by	The figures in the last column refer only to the plates illustrating the parts and are not to be used in ordering.	Plate No.
21385 B	Lower Tape Reel Axle, 7 inches long.....	39
21385 D	Lower Tape Reel Axle, 10 $\frac{3}{4}$ inches long.....	—
21388	Wrench, hardened, for $\frac{3}{8}$ inch hexagon nuts.....	28
21388 B	Wrench, hardened, for $\frac{1}{2}$ inch hexagon nuts.....	28
21388 N	Wrench, hardened, for $\frac{3}{16}$ and $\frac{5}{16}$ inch square head set screws	28
21390 A	Needle Thread Intermittent Nipper Spring, front.....	25
21390 B	Needle Thread Intermittent Nipper Spring, rear, (screw No. 22564).....	25
21390 E	Needle Thread Intermittent Nipper Spring Operating Block, (screw No. 90).....	14
21390 F	Needle Thread Intermittent Nipper Spring Operating Block Support, (screw No. 22585).....	25
21390 AS	Needle Thread Intermittent Nipper Spring Support, (screws No. 87).....	—
21390 AT	Needle Thread Intermittent Nipper Dowel Pin.....	—
21390 AU	Needle Thread Intermittent Nipper Assembly, for styles in Class 7200; also Styles 8200 A, 8200 B, 8200 C, 8200 E, 8200 M, 8200 N, 8200 O, 8200 T, 8200 V, 8200 W; one each Nos. 90, 21390 A, 21390 B, 21390 E, 21390 F, 21390 AS, 21390 AT, 22564, 22585, and two No. 87.....	25
21394	Small Utility Grinder, including emery wheel 5 inches diameter, $\frac{1}{4}$ inch face, recommended speed 3000 revolu- tions per minute.....	—
<input type="checkbox"/> 21394 G	Emery Wheel, 5 inches diameter, $\frac{1}{4}$ inch face, $\frac{3}{8}$ inch hole, grade "M," emery 60.....	—
<input type="checkbox"/> 21394 H	Emery Wheel, 5 inches diameter, $\frac{1}{2}$ inch face, $\frac{3}{8}$ inch hole, grade "M," emery 60.....	—
21394 K	Grinder, including emery wheel, 5 inches diameter, $\frac{1}{2}$ inch face, recommended speed 3000 revolutions per minute....	—
21396	Oil Cup, for oiling surface of leather.....	27
21396 AC	Needle Thread Lubricator, attaches to lower presser bar lug in place of hand lifter, thread lubricated after entering tension, (screw No. 93).....	27
21396 AG	Needle Thread Lubricator Felt.....	—
21602	Needle Thread Pull-off Post, for Styles 8200 A, 8200 C, 8200 E, 8200 M, 8200 N, 8200 O, 8200 T, 8200 V, 8200 W	24
21603	Needle Thread Pull-off Post Thread Lubricator, (screw No. 94).....	27
21605	Needle Thread Pull-off Rolling Sleeve.....	24
21606	Needle Thread Pull-off Rolling Sleeve Axle.....	24
21607	Needle Thread Pull-off Clamp Sleeve, (set screw No. 87 U)	24
21608	Needle Thread Take-up Wire, for Styles 8200 A, 8200 C, 8200 E, 8200 M, 8200 N, 8200 O, 8200 T, 8200 V, 8200 W, (set screw No. 87 U).....	24

See page 11.

LIST OF PARTS

Symbol to Order by	The figures in the last column refer only to the plates illustrating the parts and are not to be used in ordering.	Plate No.
21610 A	Needle Bar Rolling Thread Guide, for Styles 7200 A, 7200 C, 7200 T, 8200 A, 8200 C, 8200 E, 8200 M, 8200 N, 8200 O, 8200 T, 8200 V, 8200 W, (screw No. 22768).....	19
21624	Thread Controller Rolling Thread Guide, for Styles 7200 A, 7200 C, 7200 T, 8200 A, 8200 C, 8200 E, 8200 M, 8200 N, 8200 O, 8200 T, 8200 V, 8200 W, (screw No. 138).....	19
21628	Thread Controller Roller.....	19
21629	Thread Controller Roller Stud.....	12
21632	Needle Lever Rolling Thread Guide, for Styles 7200A, 7200 C, 7200 T, 8200 A, 8200 C, 8200 E, 8200 M, 8200 N, 8200 O, 8200 T, 8200 V, 8200 W, (screw No. 98 A).....	19
21640 AA	Tension Disc Separator Lever, for styles in Class 7400 having annular take up, (stud No. 21640 AC).....	25
21640 AB	Tension Disc Separator, (screws No. 90).....	24
21640 AC	Tension Disc Separator Lever Stud.....	12
21645	Tension Disc Separator Lever Connection, (screw No. 93)..	25
21646 C	Tension Disc Separator Connection, (screws No. 90).....	25
21661	Knee Press Shaft, for Styles 7200 T, 8200 V.....	36
21662	Knee Press Shaft Hanger.....	36
21683	Knee Press Assembly, for Styles 7200 T, 8200 V.....	—
21684	Knee Press Plate Rod,.....	36
21685	Knee Press Plate, (set screw No. 69 FD).....	36
21686	Knee Press Plate Connection.....	36
21687	Knee Press Chain.....	36
21688	Knee Press Chain Arm.....	36
21701 W	Base Plate, for styles in Classes 7400, 7800, equipped with puller.....	—
21703	Puller Driving Eccentric, for styles 7800 C, 7800 D, 7800 F..	26
21703 C	Puller Driving Eccentric, for styles 7400 AG, (spot screw No. 81, set screw No. 98).....	26
‡ 21707	Puller Driving Eccentric Bearing, (screws No. 22587).....	26
<input type="checkbox"/> 22508	Set Screw, square head, cup point, $\frac{1}{4}$ inch diameter, 20 threads to inch, $\frac{1}{2}$ inch long, for upper tape reel support vertical rod connection; also for No. 21173 B.....	12
<input type="checkbox"/> 22509	Set Screw, square head, cup point, $\frac{5}{16}$ inch diameter, 18 threads to inch, $\frac{1}{2}$ inch long, for thread stand rod; also for No. 21104 A.....	12
22514	Screw, $\frac{7}{16}$ inch long, for cloth plate attachments.....	11
22519	Set Screw, hexagon head for roller support of rolling presser foot assembly.....	12
22521	Screw, plus size, for cloth plates, tap No. V118.....	11
22524	Screw, for cast-off wires.....	11
22525	Screw, .010 inch plus size, length overall $\frac{5}{16}$ inch; otherwise same as No. 87.....	11
22526	Screw, plus size, diameter $\frac{3}{16}$ inch, for throat plates, tap No. V109.....	11

‡ See page 11.
 See page 11.

LIST OF PARTS

Symbol to Order by	The figures in the last column refer only to the plates illustrating the parts and are not to be used in ordering.	Plate No.
22528	Clamp Screw, for folder arm base No. 23402 A	11
22539	Plug Screw, $\frac{5}{32}$ inch long, for oiling system	12
22548	Screw, for roller support swinging arm lower bracket of rolling presser foot assembly; also for Nos. 7 F, 1593 E, 5157, 23229 D	11
22560	Screw, for link pin spring	11
22561	Screw, for feed rocker segment cover on Style 8300 K	11
22564	Screw, for needle thread intermittent nipper springs	11
22569	Screw, $\frac{3}{8} \times \frac{3}{4}$ inch long, for feed crank link; also for Nos. 12873, 12873 A	11
22575	Screw, for roller support, swinging arm of rolling presser foot assembly	11
22584	Screw, for roller support swinging arm upper bracket	11
22585	Screw, for differential feed dog in Style 8300 K; also for No. 21390 F	11
22586	Plug Screw, for needle lever stud	11
22586 A	Screw, for needle lever connecting rod upper bearing valve spring	11
22587	Screw, for needle lever connecting rod bearings; also for No. 21707	12
22590	Screw, for renewable main shaft bearing, right, in styles with annular take-up	11
22593	Screw, $\frac{9}{32}$ inch long, for main feed dog in Style 8300 K	11
22594	Screw, for English binder, on Style 7500 T	12
22596	Screw, for looper thread take-up eyelet stand; also for Nos. 8325, 8359, 15447 F	11
22597	Screw, for eccentric pulleys	11
<input type="checkbox"/> 22632F-24	Screw, square head, cup point, $\frac{3}{16}$ inch diameter, $\frac{3}{8}$ inch long, 24 threads to inch, for thread stand wires	12
<input type="checkbox"/> 22637 D	Screw, flat head, $\frac{5}{16} \times 1\frac{3}{4}$ inches, for attaching machines with pullers to base plate	12
22730	Screw, for cloth plate guards; also for No. 23406 B	11
22733	Set Screw, for differential feed bar link pin	11
22743	Lock Screw, headless, for ball bearing rolling presser foot axle, on Style 8200 T	11
22768	Screw, for needle bar thread eyelets; also for No. 8561	11
22813	Set Screw, 24 threads to inch, for lifter treadle pin	11
22818	Axle Screw, button head, for ball bearing rolling presser foot on Style 8200 T	11
23160	Lap Seam Guide, upper ply of fabric passes to left of needles, $\frac{1}{8}$ inch capacity for lower ply, $\frac{3}{4}$ inch overlap, for Nos. 5 $\frac{1}{2}$, 6, and 32 gauge, Styles 7800 A, 7800 C, (screws No. 25 C)	29
23163 L-48	Folder, lower, for No. 48 gauge Style 7400 U, uses strip 1 $\frac{1}{4}$ inches wide, (screws No. 25 C)	30

See page 11.

LIST OF PARTS

Symbol to Order by	The figures in the last column refer only to the plates illustrating the parts and are not to be used in ordering.	Plate No.
23167 B	Lap Seam Guide, lower section, upper ply of fabric passes to right of needles, adjustable overlap, for Nos. 40 and 48 gauge Styles 7800 A, 7800 C.....	29
23167 G	Lap Seam Guide, upper section, for use with No. 23167 B, (screws No. 22514).....	29
23170- $\frac{1}{8}\frac{1}{4}$	Lap Seam Feller, adjustable, $\frac{1}{8}\frac{1}{4}$ inch capacity, for Nos. 5, $5\frac{1}{2}$ and 6 gauge Styles 7800 B, 7800 D.....	30
23170 J-48- $\frac{1}{8}\frac{1}{4}$	Lap Seam Feller, adjustable, $\frac{1}{8}\frac{1}{4}$ inch capacity, for Nos. 40 and 48 gauge Styles 7800 B, 7800 D, (screws No. 25 C, adjusting screws No. 604).....	29
23184 H	Folder and Guide, for Style 7800 F, (screws No. 25 C).....	30
23201	Lap Seam Guide, upper ply of fabric passes to left of needles, $\frac{1}{16}$ inch capacity for lower ply, $\frac{1}{2}$ inch overlap, for No. 5 gauge Styles 7800 A, 7800 C, (screws No. 25 C).....	29
23204-4- $\frac{1}{3}\frac{1}{2}$	Lap Seam Feller, nonadjustable, $\frac{1}{3}\frac{1}{2}$ inch capacity, for No. 4 gauge, upper ply of fabric passes to right of needles, delivery end is oblique with line of feed.....	30
23204-4- $\frac{1}{16}$	Lap Seam Feller, $\frac{1}{16}$ inch capacity, for No. 4 gauge.....	30
23204-4- $\frac{3}{32}$	Lap Seam Feller, $\frac{3}{32}$ inch capacity, for No. 4 gauge.....	30
23204-4 $\frac{1}{2}$ - $\frac{1}{3}\frac{1}{2}$	Lap Seam Feller, $\frac{1}{3}\frac{1}{2}$ inch capacity, for No. 4 $\frac{1}{2}$ gauge.....	30
23204-4 $\frac{1}{2}$ - $\frac{1}{16}$	Lap Seam Feller, $\frac{1}{16}$ inch capacity, for No. 4 $\frac{1}{2}$ gauge.....	30
23204-4 $\frac{1}{2}$ - $\frac{3}{32}$	Lap Seam Feller, $\frac{3}{32}$ inch capacity, for No. 4 $\frac{1}{2}$ gauge.....	30
23215 G	Lap Seam Feller Screws No. 25 C. English Binder, for Style 7500 T, using 2 inch binding strip, (screws No. 22594).....	29
23223-2	Binding Guide, for Style 7500 T, using 2 inch binding strip, (screws No. 25 C).....	29
23227 A	Supplemental Base, for folder and guide on Style 8200 S....	29
23229 B	Suspended Folder Swinging Arm, for Style 7400 AF, (clamp screw No. 93).....	25
23229 C	Suspended Folder Swinging Arm Stop, (screws No. 88).....	25
23229 D	Suspended Folder Bracket, (screws No. 22548).....	25
23229 J	Suspended Folder Swinging Arm Assembly; one each Nos. 93, 23229 B, 23229 C, two No. 23229 D, and four No. 88....	—
23253 B	Presser Foot Folder, for Style 8300 K, (screws No. 22561)...	29
23253 F	Plate Folder, for Style 8300 K, (screws No. 25 C).....	30
23279 D	Folder Threader.....	28
23297 D	Folder, for attaching inside button stays, strip guided next to feed dog.....	30
23386- $\frac{5}{8}$	Reverse Hemmer, with elastic guide, for $\frac{1}{4}$ inch heading, on Style 7400 AG.....	35
23386 A- $\frac{1}{2}$	Reverse Hemmer, with elastic guide, for $\frac{1}{8}$ inch heading, (screws No. 25 C).....	35

LIST OF PARTS

Symbol to Order by	The figures in the last column refer only to the plates illustrating the parts and are not to be used in ordering.	Plate No.
23400-48	Center Plait Attachment, complete, $\frac{3}{64}$ inch capacity, reversible, quick loading, tiltable design, attaches to cloth plate, channeled interlining chute, plaits extend $\frac{1}{4}$ inch beyond rows of stitches, uses $2\frac{1}{4}$ inch strip either garment or long lengths for plait and $1\frac{3}{16}$ inch strip for interlining, for No. 48 gauge, Styles 7400 X, 7400 Y, 7400 AH, 7400 AM, 7400 AN, one each Nos. 23401-48, 22528, 23402, 23402 A, 23403-48, and two each Nos. 25 B, 94 and 22514; replaces Nos. 23298-48, 23299-48.....	31
23400 A-48	Center Plait Attachment, complete, $\frac{3}{64}$ inch capacity, reversible, tiltable design, without interlining chute, attaches to cloth plate, plaits extend $\frac{1}{4}$ inch beyond rows of stitches, uses $2\frac{1}{4}$ inch strip either garment or long lengths, for No. 48 gauge Styles 7400 V, 7400 W; one each Nos. 23401 A-48, 22528, 23402, 23402 A and two each Nos. 94 and 22514; replaces Nos. 23296-48, 23297-48.....	32
23400 B-48	Facing Strip Folder, complete, $\frac{3}{64}$ inch capacity, for center plaits or button stays, reversible, attaches to top of cloth plate, uses $1\frac{1}{4}$ inch strip, extends $\frac{1}{16}$ inch beyond rows of stitches, for No. 48 gauge Styles 7400 V, 7400 W, 7400 X, 7400 Y, 7400 AA, 7400 AF; one each Nos. 23401 B-48, 23402 C, 23403-48 and two each Nos. 25 B, 88 A and 22514; replaces Nos. 23292-48, 23292 A-48, 23293-48, 23293 A-48	31
23400 C-48	Button Stay Attachment, complete, $\frac{3}{64}$ inch capacity, reversible, tiltable design, attaches to cloth plate, uses $1\frac{1}{4}$ inch strip, extends $\frac{1}{16}$ inch beyond rows of stitches, for No. 48 gauge Styles 7400 AA, 7400 AJ; one each Nos. 23401 C-48, 22528, 23402, 23402 A, and two each Nos. 94 and 22514; replaces No. 23294.....	32
23400 N-48	Center Plait Attachment, complete, $\frac{3}{64}$ inch capacity, quick loading, suspended from arm, channeled interlining chute, plaits extend $\frac{1}{4}$ inch beyond rows of stitches, uses $2\frac{1}{4}$ inch strip for plait and $1\frac{3}{16}$ inch strip for interlining, either garment or long lengths; one each Nos. 23401-48, 23402 B, 23403-48, two each Nos. 25 B, and four No. 94; replaces No. 23298 A-48.....	33
23400 P-48	Center Plait Attachment, complete, $\frac{3}{64}$ inch capacity, without interlining chute, suspended from arm, plaits extend $\frac{1}{4}$ inch beyond rows of stitches, uses $2\frac{1}{4}$ inch strip, either garment or long lengths, for No. 48 gauge Style 7400 AF, one each Nos. 23401 A-48, 23402 B and four No. 94; replaces No. 23296 A-48.....	33
23400 Q-48	Button Stay Attachment, complete, $\frac{3}{64}$ inch capacity, suspended from arm, uses $1\frac{1}{4}$ inch strip, extends $\frac{1}{16}$ inch beyond rows of stitches; one each Nos. 23401 C-48, 23402 B and four No. 94; replaces No. 23294 A-48.....	33

LIST OF PARTS

Symbol to Order by	The figures in the last column refer only to the plates illustrating the parts and are not to be used in ordering.	Plate No.
23401-48	Folder, for attaching center plaits, $\frac{3}{8}$ inch capacity, reversible, quick loading, has channeled interlining chute, plaits extend $\frac{1}{4}$ inch beyond rows of stitches, uses $2\frac{1}{4}$ inch strip either garment or long lengths, for plait and $1\frac{3}{8}$ inch strip for interlining, for No. 48 gauge Styles 7400 X, 7400 Y, 7400 AH, 7400 AM, 7400 AN.	31
23401 A-48	Folder, for attaching center plaits without interlining, for No. 48 gauge Styles 7400 V, 7400 W; otherwise same as No. 23401-48, (screws No. 94).....	32
23401 B-48	Folder, for facing strip of center plaits or button stays, $\frac{3}{8}$ inch capacity, uses $1\frac{1}{4}$ inch strip, extends $\frac{1}{8}$ inch beyond rows of stitches, for No. 48 gauge Styles 7400 V, 7400 W, 7400 X, 7400 Y, 7400 AA, 7400 AF, 7400 AH, 7400 AJ, 7400 AM, 7400 AN, (screws No. 88 A).....	31
23401 C-48	Folder, for attaching button stays, $\frac{3}{8}$ inch capacity, uses $1\frac{1}{4}$ inch strip, extends $\frac{1}{8}$ inch beyond rows of stitches, for No. 48 gauge Styles 7400 AA, 7400 AJ, (screws No. 94).....	32
23402	Folder Arm, forked, reversible, for Styles 7400 V, 7400 W, 7400 X, 7400 Y, 7400 AA, 7400 AH, 7400 AJ, 7400 AM, 7400 AN.....	31
23402 A	Folder Arm Base, (clamp screw No. 22514, screws No. 22528)	31
23402 B	Suspended Folder Support, attaches to arm No. 23229 B, for Style 7400 AF, (screws No. 94).....	33
23402 C	Folder Base, for facing strip, reversible, on Styles 7400 V, 7400 W, 7400 X, 7400 Y, 7400 AA, 7400 AF, 7400 AH, 7400 AJ, (screws No. 22514).....	31
23402 D	Folder Base, for Style 7400 AK, (screws No. 25 C).....	29
23403-48	Angular Strip Guide, reversible, for No. 48 gauge Styles 7400 V, 7400 W, 7400 X, 7400 Y, 7400 AA, 7400 AF, 7400 AH, 7400 AJ, 7400 AM, 7400 AN, (screws No. 25 B)	31
23404	Edge Guide, for body of garment, on Styles 7400 U, 7400 V, 7400 X, replaces No. 23300.....	30
23405 B	Folder, for body of garment on Style 7400 AH.....	29
23405 C	Folder, for body of garment on Style 7400 AJ, (screws No. 25 C).....	29
23406 B- $\frac{7}{8}$	Folder, for attaching button stays to sleeves on Style 7400 AK, (screws No. 22730).....	35
28606- $\frac{1}{2}$	Powdered Oil Stone, $\frac{1}{2}$ lb. package.....	—
28606-1	Powdered Oil Stone, 1 lb. package.....	—
29066 B	Needle Lever Connecting Rod Upper Bearing Assembly; one each Nos. 1230 A, 156, lapped together, 1230 B, 1230 D, 22586 A.....	18
29070 B	Eccentric Pulley Assembly, wick feed oiling, for styles in Classes 7500, 7800; one each Nos. 11721, 15430 M, lapped together.....	—

LIST OF PARTS

Symbol to Order by	The figures in the last column refer only to the plates illustrating the parts and are not to be used in ordering.	Plate No.
29070 D	Eccentric Pulley Assembly, wick and splash feed oiling, for styles in Classes 7500, 7800; one each Nos. 11721, 1230 G, lapped together, and two No. 41046 G.....	—
29086 A	Eccentric Pulley Assembly, wick feed oiling, for styles in Classes 7000, 7200; one each Nos. 1221, and 15430 M, lapped together.....	—
29086 E	Eccentric Pulley Assembly, wick and splash feed oiling for styles in Classes 7000, 7200; one each Nos. 1221, 1230 G, lapped together, and two No. 41046 G.....	—
29087 A	Eccentric Pulley Assembly, wick and splash feed oiling, for styles having double disc take-up in Classes 7400, 8200, 8300, one each Nos. 7421 and 15430 M, lapped together..	26
29087 D	Eccentric Pulley Assembly, wick feed oiling, for styles having annular take-up in Class 7400, one each Nos. 7421 A and 15430 M, lapped together.....	—
29087 E	Eccentric Pulley Assembly, wick and splash feed oiling, for styles having double disc take-up, in Classes 7400, 8200, 8300, one each Nos. 7421, 1230 G, lapped together, and two No. 41046 G.....	—
29138	Puller Driving Eccentric Assembly, for Styles 7800 C, 7800 D, 7800 F; one each Nos. 21703 and 21707, lapped together..	26
29138 C	Puller Driving Eccentric, for Style 7400 AG; one each Nos. 21703 C, 21707, lapped together.....	—
29155	Looper Rocker Assembly, for Style 8200 V, one each Nos. 182, 30, 33, lapped together, and No. 34.....	—
29155 J	Looper Rocker Assembly, for styles in Classes 7400, 8300; also Styles 8200 A, 8200 C, 8200 E, 8200 M, 8200 N, 8200 O, 8200 S, 8200 T, 8200 W; one each Nos. 182, 15465 J, 15745 B, lapped together, 6038, 12987 A, and two No. 88	—
29156	Looper Rocker Assembly, for Style 7200 T, one each Nos. 183, 30, 33, lapped together, and No. 34.....	—
29157 K	Looper Rocker Assembly, for styles in Classes 7500, 7800; one each Nos. 183 A, 15465 F, 15745 B, lapped together, 6038 B, 12987 A and two No. 88.....	—
29200-1	Needle Bar Assembly, for No. 1 gauge styles having left needle in front, one each Nos. 50 C-1, 56 B-2 and two No. 88 B.....	—
29200-2	Needle Bar Assembly, for No. 2 gauge, one each Nos. 50 C-2, 56 B-2, and two No. 88 B.....	—
29200-3	Needle Bar Assembly, for No. 3 gauge; one each Nos. 50 C-3, 56 B-2, and two No. 88 B.....	—
29200-4	Needle Bar Assembly, for No. 4 gauge, one each Nos. 50 C-4, 56 B-4, and two No. 88 B.....	—
29200-4 $\frac{1}{4}$	Needle Bar Assembly, for No. 4 $\frac{1}{4}$ gauge, one each Nos. 50 C-4 $\frac{1}{4}$, 56 B-4, and two No. 88 B.....	—

LIST OF PARTS

Symbol to Order by	The figures in the last column refer only to the plates illustrating the parts and are not to be used in ordering.	Plate No.
29200-4 $\frac{1}{2}$	Needle Bar Assembly, for No. 4 $\frac{1}{2}$ gauge; one each Nos. 50 C-4 $\frac{1}{2}$, 56 B-4, and two No. 88 B.....	—
29200-5	Needle Bar Assembly, for No. 5 gauge; one each Nos. 50 C-5, 89, 7018 E-5, and two No. 98.....	—
29200-5 $\frac{1}{4}$	Needle Bar Assembly, for No. 5 $\frac{1}{4}$ gauge, one each Nos. 50 C-5, 89, 7018 E-5 $\frac{1}{4}$, and two No. 98.....	—
29200-5 $\frac{1}{2}$	Needle Bar Assembly, for No. 5 $\frac{1}{2}$ gauge; one each Nos. 50 C-6, 89, 7018 E-5 $\frac{1}{2}$, and two No. 98.....	—
29200-6	Needle Bar Assembly, for No. 6 gauge; one each Nos. 50 C-6, 89, 7018 E-6, and two No. 98.....	—
29200-28	Needle Bar Assembly, for No. 28 gauge, one each Nos. 50 C-6, 89, 7018 E-28 and two No. 98.....	—
29200-30	Needle Bar Assembly, for No. 30 gauge, one each Nos. 50 C-6, 89, 7018 E-30 and two No. 98.....	—
29200-32	Needle Bar Assembly, for No. 32 gauge, one each Nos. 50 C-6, 89, 7018 E-32 and two No. 98.....	—
29200-34	Needle Bar Assembly, for No. 34 gauge, one each Nos. 50 C-6, 89, 7018 E-34 and two No. 98.....	—
29200-36	Needle Bar Assembly, for No. 36 gauge, one each Nos. 50 C-6, 50 J-40, 89, 7018 E-40, and two No. 98.....	—
29200-40	Needle Bar Assembly, for No. 40 gauge, one each Nos. 50 C-6, 50 J-40, 89, 7018 E-40 and two No. 98.....	—
29200-44	Needle Bar Assembly, for No. 44 gauge, one each Nos. 50 C-6, 50 J-40, 89, 7018 E-44 and two No. 98.....	—
29201-48	Needle Bar Assembly, for No. 48 gauge, one each Nos. 7917, 89, 7918-48, 7933-48 and two each Nos. 98, 605 A.....	—
29203-00	Needle Bar Assembly, for No. 00 gauge styles having right needle in front, one each Nos. 160 A-00, 89, 164-1, and two No. 88 B.....	—
29203-0	Needle Bar Assembly, for No. 0 gauge, one each Nos. 160 A-0, 89, 164-1 and two No. 88 B.....	—
29203-1	Needle Bar Assembly, for No. 1 gauge, one each Nos. 160 A-1, 89, 164-1, and two No. 88 B.....	—
29203-2	Needle Bar Assembly, for No. 2 gauge, one each Nos. 160 A-2, 89, 164-1, and two No. 88 B.....	—
29203-3	Needle Bar Assembly, for No. 3 gauge, one each Nos. 160 A-3, 56 B-2, and two No. 88 B.....	—
29203-4	Needle Bar Assembly, for No. 4 gauge, one each Nos. 160 A-4, 56 B-2, and two No. 88 B.....	—
29203-4 $\frac{1}{4}$	Needle Bar Assembly, for No. 4 $\frac{1}{4}$ gauge, one each Nos. 160 A-4 $\frac{1}{4}$, 56 B-4, and two No. 88 B.....	—
29203-4 $\frac{1}{2}$	Needle Bar Assembly, for No. 4 $\frac{1}{2}$ gauge, one each Nos. 160 A-4 $\frac{1}{2}$, 56 B-4, and two No. 88 B.....	—
29203-5	Needle Bar Assembly, for No. 5 gauge, one each Nos. 160 A-5, 56 B-4 and two No. 88 B.....	—

LIST OF PARTS

Symbol to Order by	The figures in the last column refer only to the plates illustrating the parts and are not to be used in ordering.	Plate No.
29203-5 $\frac{1}{4}$	Needle Bar Assembly, for No. 5 $\frac{1}{4}$ gauge, one each Nos. 50 C-6, 89, 8318-5 $\frac{1}{4}$ and two No. 98.....	—
29203-5 $\frac{1}{2}$	Needle Bar Assembly, for No. 5 $\frac{1}{2}$ gauge, one each Nos. 50 C-6, 89, 8318-5 $\frac{1}{2}$ and two No. 98.....	—
29304 E	Needle Lever Cone Bearing Stud Assembly; one each Nos. 1286, 6090 A, 6093, lapped together and two each Nos. 88, 11638 M.....	25
29402	Lifter Treadle Assembly; one each Nos. 422, 423, 424, 22813	36
29435 A	Cloth Plate Assembly, with stay cutting mechanism, for Styles 7200 T, 8200 V; one each Nos. 7201 T, 90, 93, 459, 3335 A, 3336 B, 3336 C, 3338 A, 3339, 3340, 3341, 3342, 3343, 3345 A, 3346, 3346 A, 3348, 3349, 9675, two each Nos. 75, 97, 98, 187 A, 907, 3344, and four No. 87 U.....	—
35582 B	Tension Thread Eyelet, for styles in Class 7400 having annular take-up.....	19
41046 G	Spring Valve Oiler.....	14

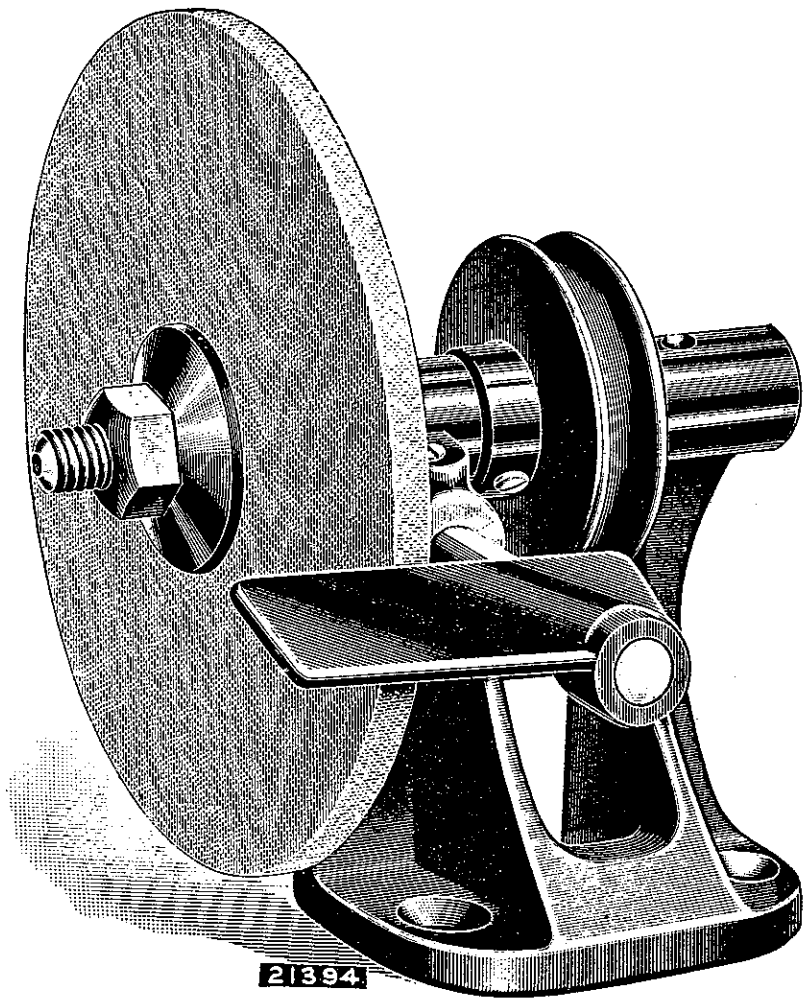

21394

Utility Grinder

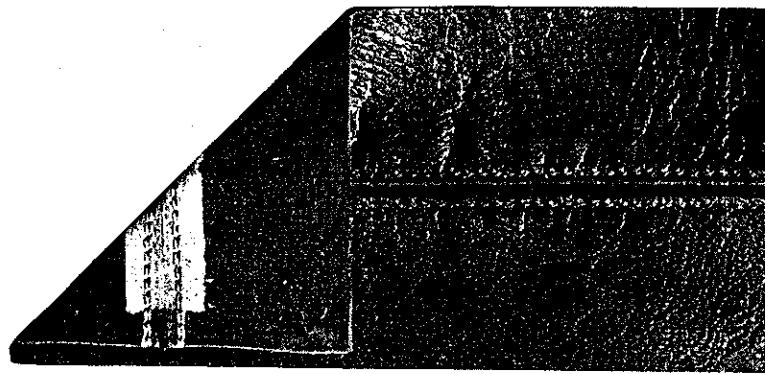

**Photographic reproduction showing both surfaces
of a two-operation stayed seam as
produced on Style 7200 T**

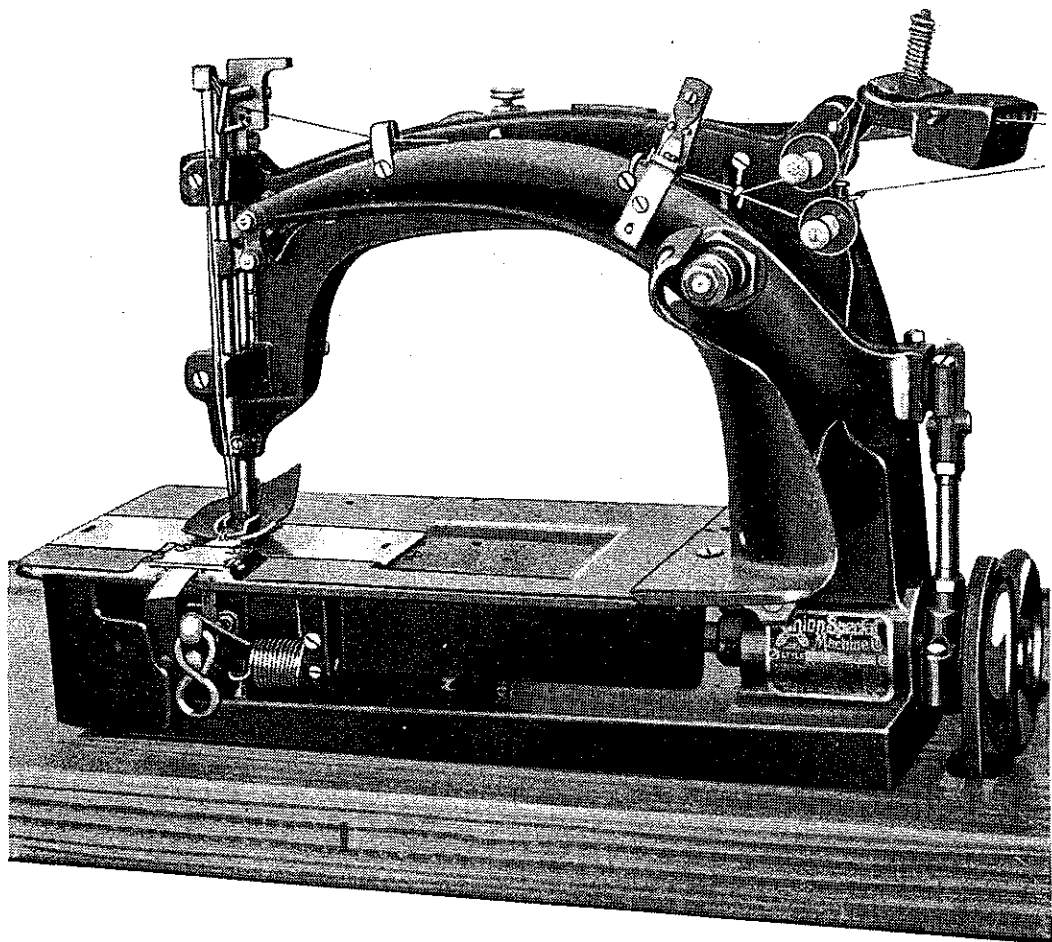

Style 7200 T

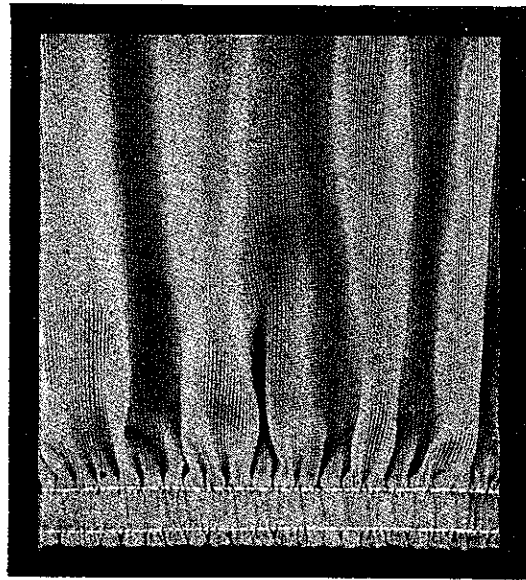

$\frac{1}{8}$ inch Heading

Photographic reproductions of hems produced on Style 7400 AG-5

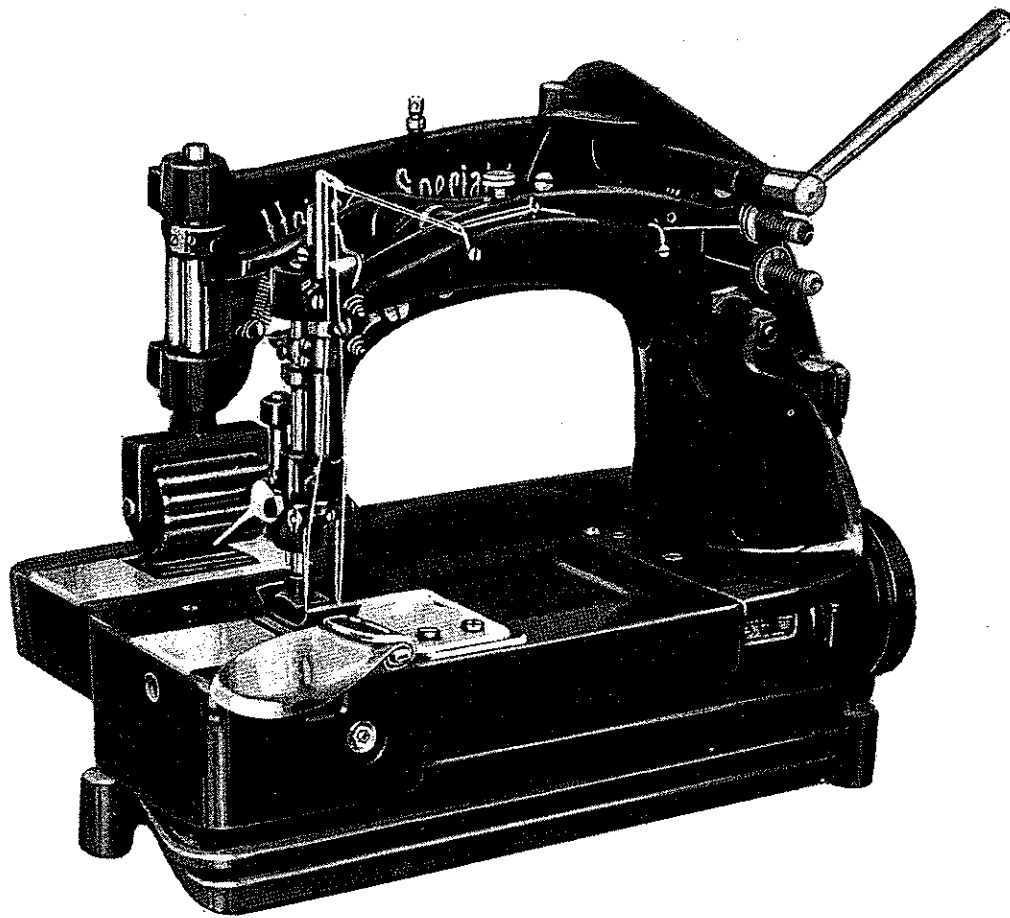

Style 7400 AG

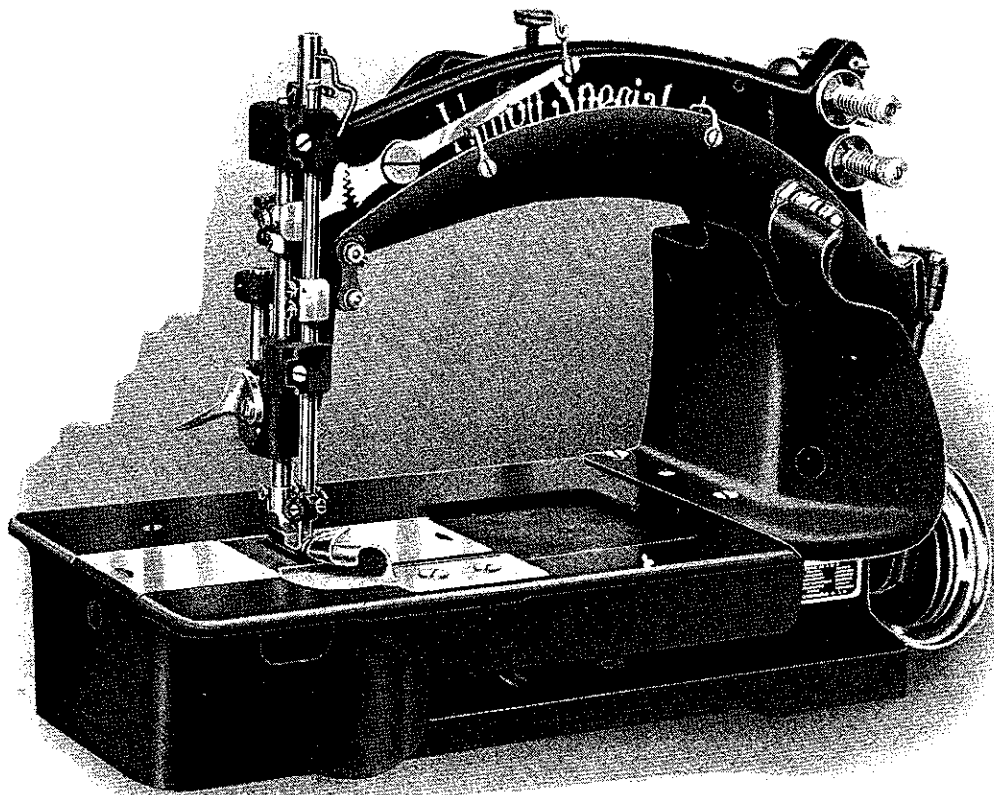

Style 7500 B

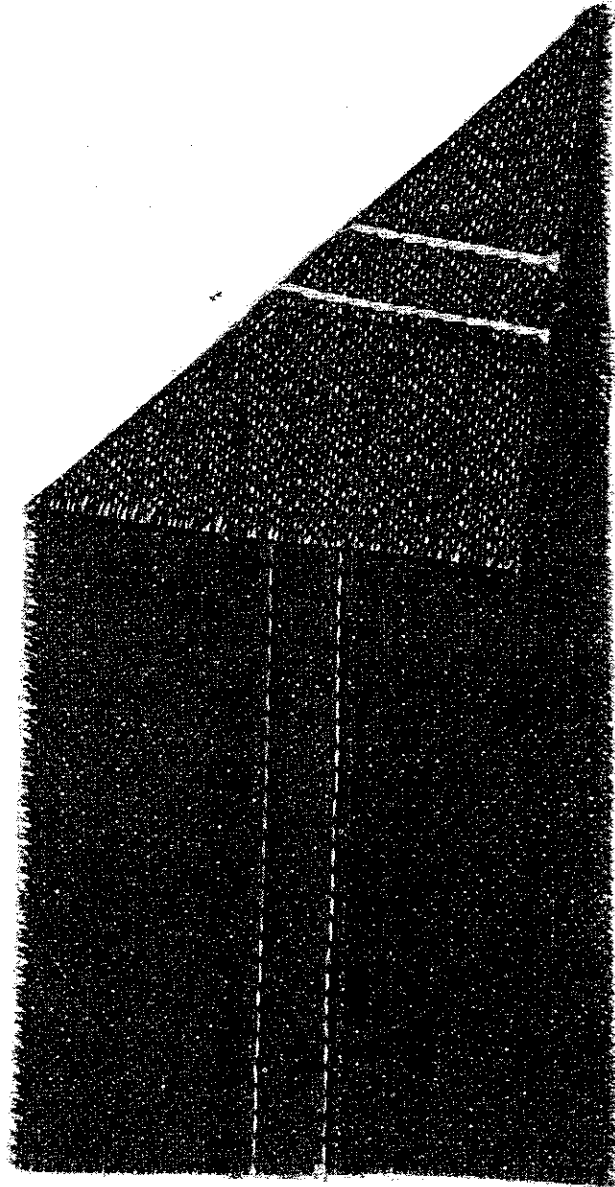

**Sample of Double Lap Seam Felling
Accomplished on Style 7500 B**

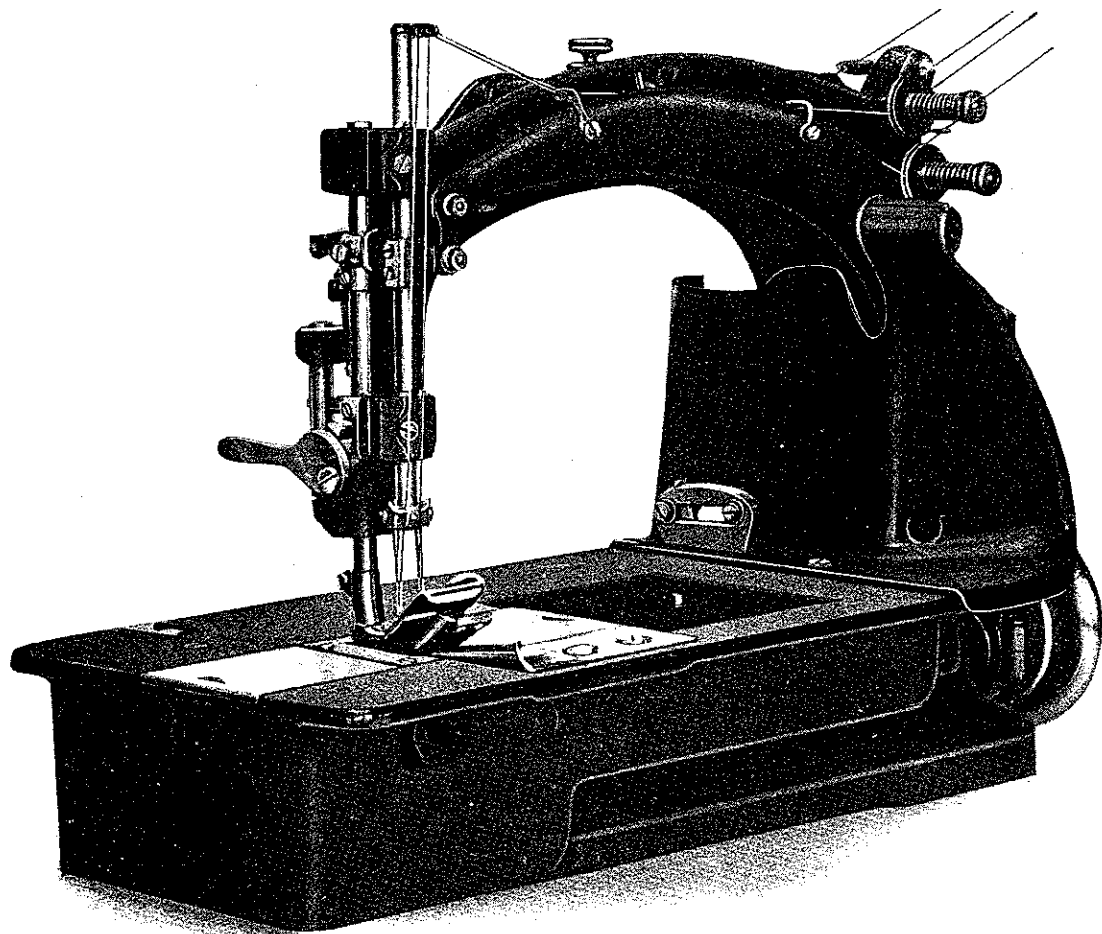

Style 8300 K



Union Special[®]
INDUSTRIAL SEWING MACHINES

UNION SPECIAL maintains sales and service facilities throughout the world. These offices will aid you in the selection of the right sewing equipment for your particular operation. Union Special representatives and service men are factory trained and are able to serve your needs promptly and efficiently. Whatever your location, there is a Union Special Representative to serve you. Check with him today.

ATLANTA, GA.	MONTREAL, QUEBEC
BOSTON, MASS.	BRUSSELS, BELGIUM
CHICAGO, ILL.	LEICESTER, ENGLAND
DALLAS, TEXAS	LONDON, ENGLAND
LOS ANGELES, CAL.	PARIS, FRANCE
NEW YORK, N. Y.	STUTTGART, GERMANY
PHILADELPHIA, PA.	

Representatives and distributors in all important industrial cities throughout the world.

Union Special
MACHINE COMPANY

400 N. FRANKLIN ST., CHICAGO, ILL. 60610