

**THIRD  
EDITION**



*Union Special*  
INDUSTRIAL SEWING EQUIPMENT

**CATALOG NO. 87L**

---

---

**STYLES**

**60000 C**

**60000 D**

---

---

**MACHINES FOR CLOSING PAPER BAGS**

**TAPE BOUND SEAM**

Catalog No. 87 L

LIST OF PARTS

FOR

STYLES

60000 C

60000 D

Third Edition

Copyright 1945

by

Union Special Machine Co.  
Rights Reserved in All Countries

*Union Special*

**MACHINE COMPANY**

INDUSTRIAL SEWING MACHINES

**CHICAGO**

Printed in U.S.A.

April, 1973

## FOREWORD

It is our constant aim to furnish carefully prepared information that will enable the customer to secure all possible economies and advantages from the use of Union Specials. On the pages which follow will be found illustrations and descriptions of the parts for Styles 60000 C and 60000 D.

Additional catalogs, containing information relative to these machines, and which will be furnished upon request, are listed below.

Catalog No. 45 N	Needle Manual
Catalog No. 87 A	Instructions for Adjusting Style 60000 D

In all manufacturing centers will be found Union Special representatives, who will cooperate with those who desire in planning and estimating their requirements.

*Union Special* MACHINE COMPANY

Engineering Department

## IDENTIFICATION OF MACHINES

Each Union Special carries a Style number which is stamped in the name plate on the machine. Style numbers are classified as standard and special. Those which are standard have one or more letters suffixed, but never contain the letter "Z". Example: "60000 C". Style numbers containing the letter "Z" are special. When only minor changes are made in a standard machine a "Z" is merely suffixed to the respective standard style number. Example: "60000 CZ".

Styles of machines similar in construction are grouped under a class number which differs from the style number in that it contains no letters. Example: "60000".

## APPLICATION OF CATALOG

This catalog applies only to the standard styles of machines as listed herein. It can also be applied with discretion to special machines in Class 60000.

## DESCRIPTION OF MACHINES

60000 C Flat Bed, Single Needle, Chain Stitch Type 101, Rotary Hook, for closing small filled paper bags on Styles 20100 P and 21800 N, with two paper reinforcing tapes, one guided next to presser foot, the other guided next to feed dog, seam Type SSa-1, round belt drive, trimming mechanism for top of bag, automatic cutter for severing tape between bags, stitch range 8 to 5 per inch, standard length 5 per inch.

60000 D Flat Bed, Single Needle, Chain Stitch Type 101, Rotary Hook, for closing small filled paper bags on Styles 20100 P and 21800 N, with two paper reinforcing tapes, one guided next to presser foot, the other guided next to feed dog, seam Type SSa-1, round belt drive, trimming mechanism for top of bag, improved automatic cutter for severing tape between bags, stitch range 8 to 5 per inch, standard length 5 per inch.

60000 Z A special Style, similar to the standard Style in Class 60000, but differing in one or more of its component parts.

## NEEDLES

### TYPE NUMBERS AND SIZES

Each needle has a type number and size number. The former denotes the kind of shank, point, length, groove, finish, and other details. The latter denotes the largest diameter of the blade, measured in thousandths of an inch midway between the shank and eye, and is stamped in the needle shank. Collectively, the type number and size number is the complete symbol.

To have orders promptly and accurately filled, the empty package, a sample needle, or the type and size number should be given. Use description on label. A complete order would read: "100 Needles, Type 924, Size 080".

## NEEDLES (Continued)

The type number of the needle most commonly used in the styles of machines covered by this catalog is listed below. Opposite the type number is the description of the needle and sizes available.

Type No.	Description
924	Round shank, spear point, short, double groove, spotted, plain finish - Sizes 042, 049, 054, 067, 073, 080

## ORDERING REPAIR PARTS

### PLATES

Illustrations of parts are arranged according to scale and whenever possible, parts similar in appearance or function are grouped together.

When a given design of part is made in two or more sizes, only one illustration is usually shown. In ordering these pieces, it is necessary that the additional information be furnished as requested under these illustrations.

### LIST OF PARTS

Turning from the plates to the list of parts, the description of each part and its principal uses will be found. Always check the symbol against its description before ordering. It is not necessary to furnish the plate number.

When a part is used, or can be used, in all machines covered by this catalog, no specific use is mentioned in the description.

For convenience in ordering, minor parts such as screws, nuts and similar articles are repeated after each major part.

(-) A dash in the "plate number" column of the list of parts indicates the absence of an illustration.

(‡) A double dagger in the "symbol to order by" column indicates that the component parts cannot be furnished separately.

### IDENTIFYING PARTS

When the construction permits, each part is stamped with its part number. Some of the smaller parts are stamped with an identification letter to distinguish them from parts similar in appearance.

All part numbers represent the same part, regardless of the catalog in which they appear.

### SUPPLIES

All supplies, including taps, reamers, belting, belt hooks, belt fasteners, screw drivers, wrenches and powdered oil stone will be promptly furnished.

## ORDERING REPAIR PARTS (Continued)

### USE GENUINE NEEDLES AND REPAIR PARTS

Success in the operation of these machines can be secured only by the use of genuine Union Special Needles and Repair Parts as furnished by the Union Special Machine Company, its subsidiaries and authorized distributors. They are designed according to the most approved scientific principles, and are made with the utmost precision. The maximum efficiency and durability are assured.

Genuine needles are packaged with labels marked *Union Special*. Genuine repair parts are stamped with the Union Special trade mark. Each trade mark is your guarantee of the highest quality in materials and workmanship.

### TERMS

Prices are net cash and subject to change without notice. All shipments are forwarded f. o. b. shipping point. Parcel Post shipments are insured, unless otherwise directed. A charge is made to cover postage and insurance.

Plate 1 - Full Size

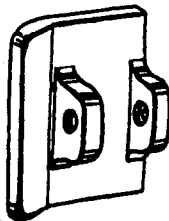
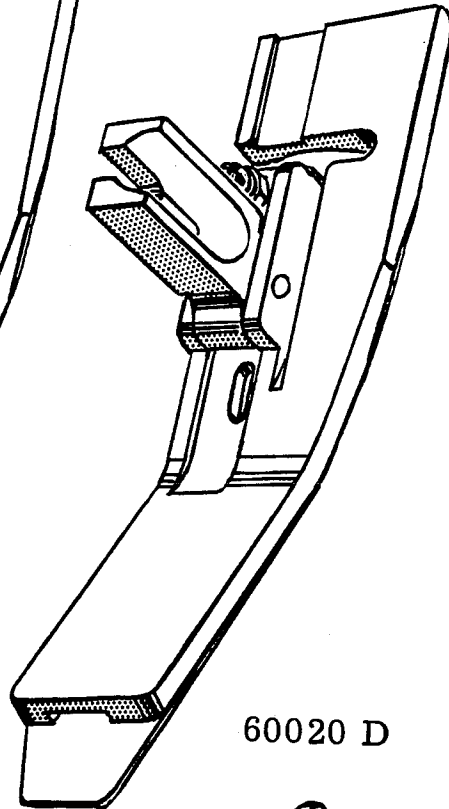
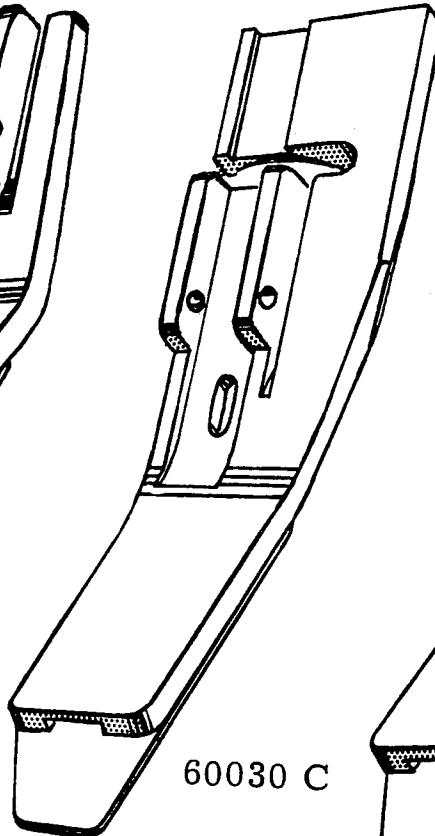
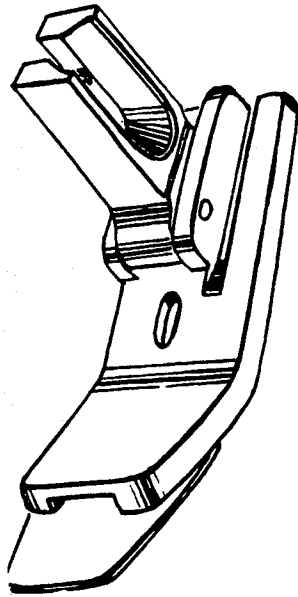
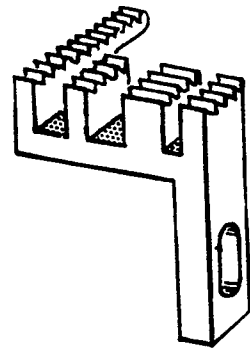
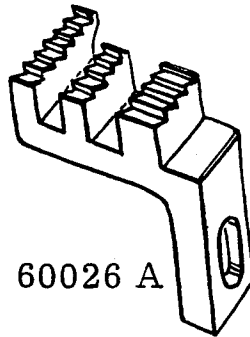
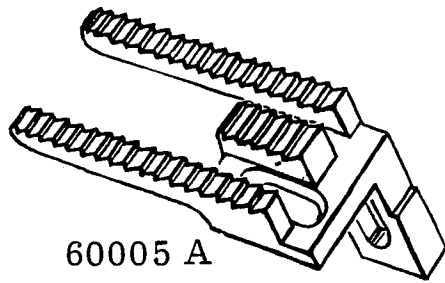

60027 A

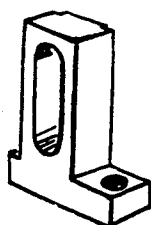

60071

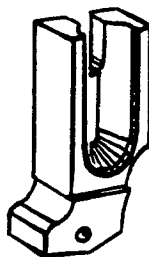

60030

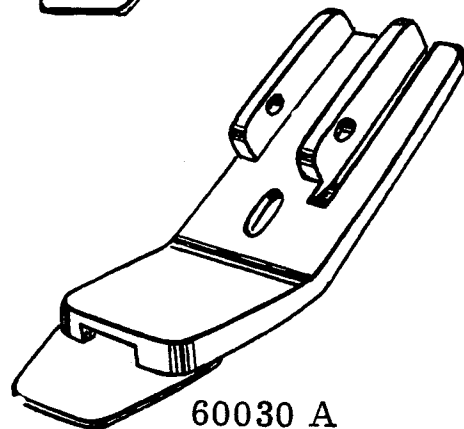

60030 A

Plate 2 - Full Size

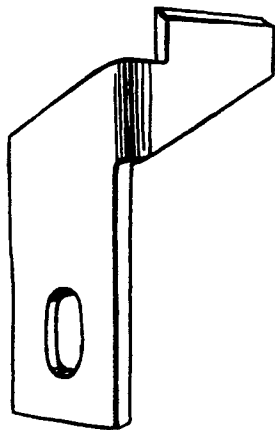

60075 G



60070



K62216

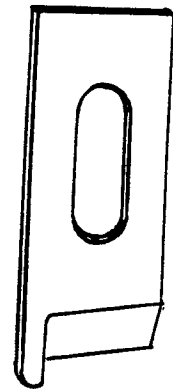

60075

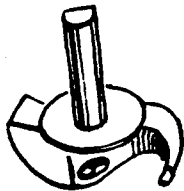

60008 A



61233 N

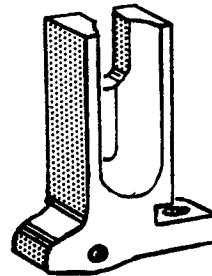

60030 B

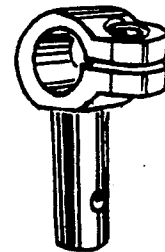

60073 N

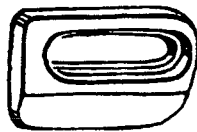

60079 A

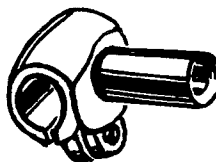

61255



666-11

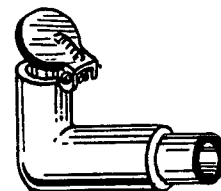

666-24



666-83

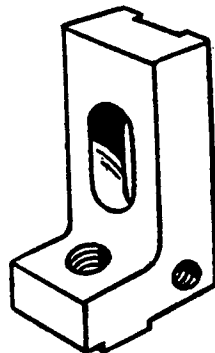

60079 B

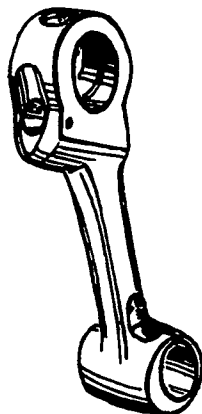

61255 G



60040 A

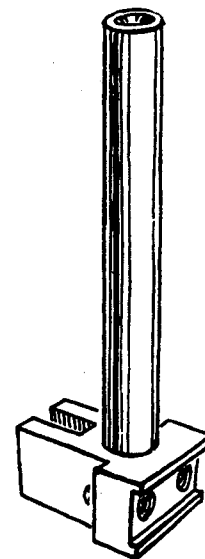

60073



Plate 3 - Full Size

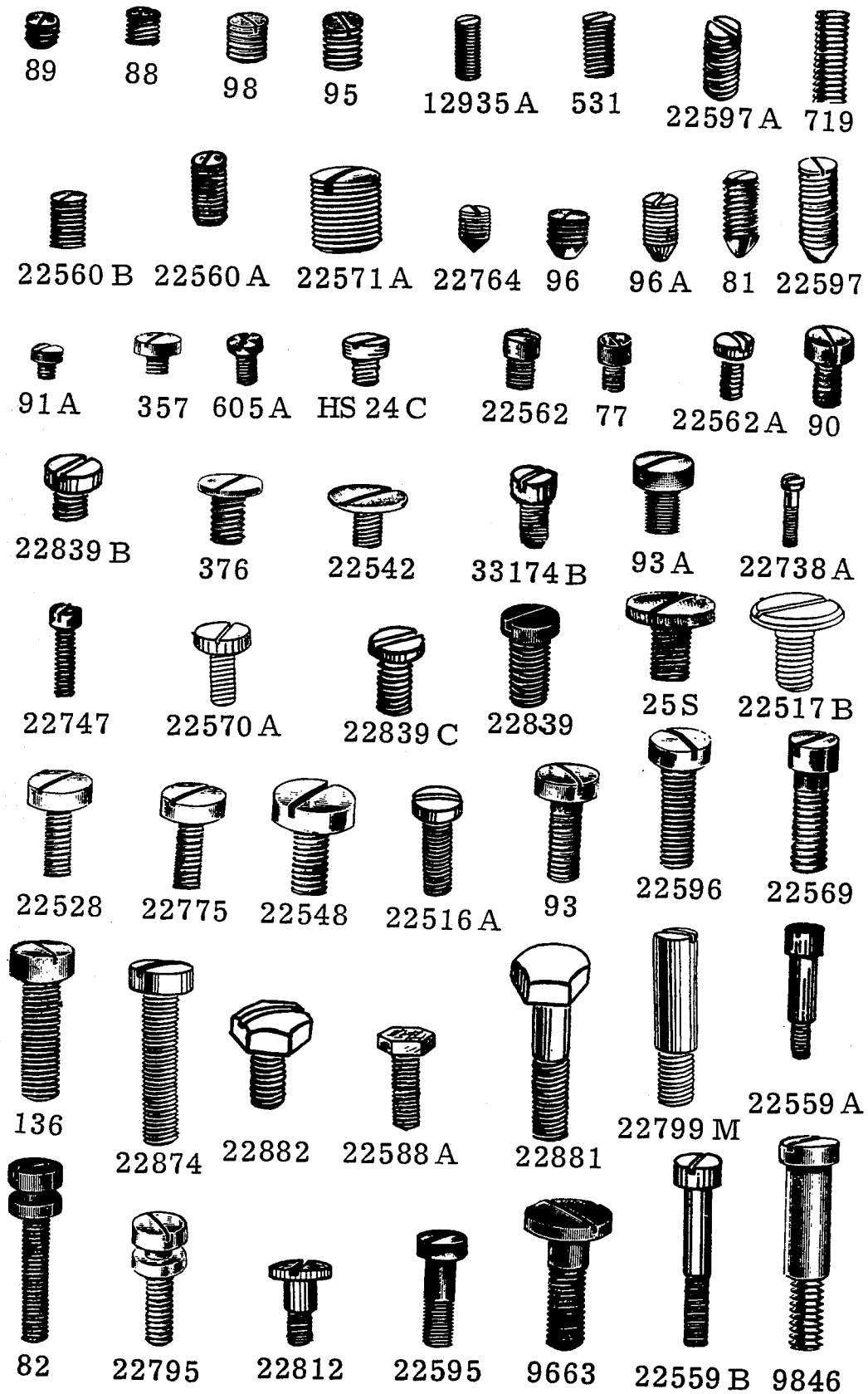
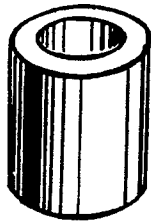

Plate 4 - Full Size



Plate 5 - Full Size



60078 E

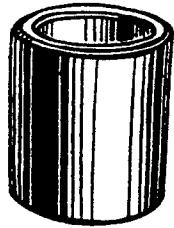

60032 N

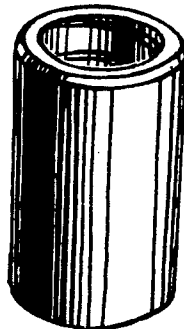

61263



60090 H

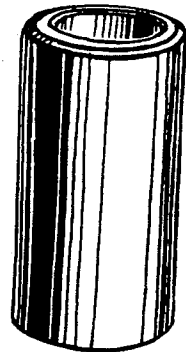

60032 W

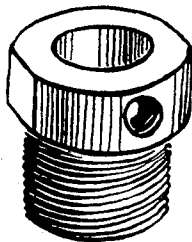

60093 K

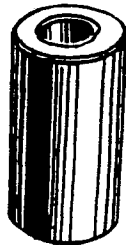

60041 A

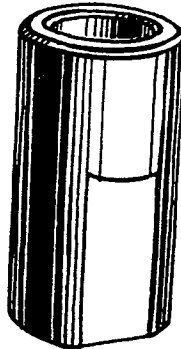

60090 G

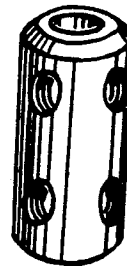

60040 B

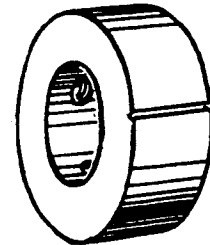

60032 C

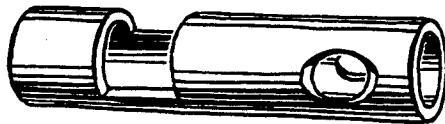

60036 U

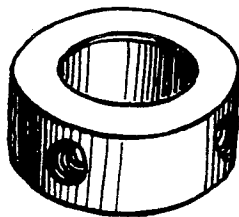

60064

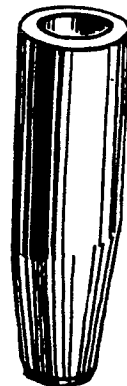

61254

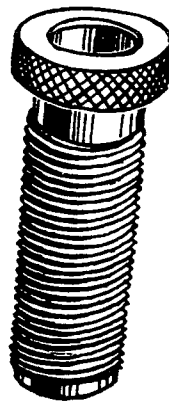

61257 G



60079 F

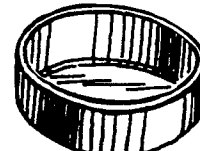

61293 N



60093 G

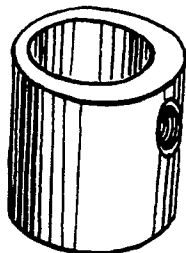

60093



21113 B

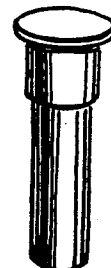

60091 G

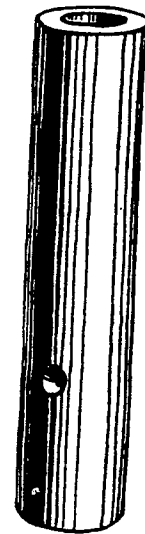

60041

Plate 6 - Full Size



1066



61242

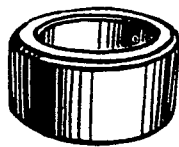

60032 U



61254 A



60035



60042



60036 W



61330 B-35



61267 G

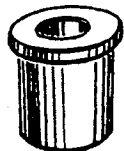

60038 G

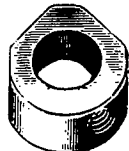

2538



60079 M

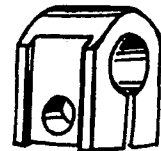

60058 G



60077 H

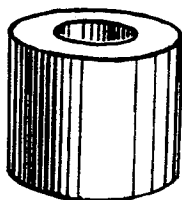

60077 J

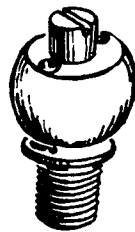

39544 H



60077 K

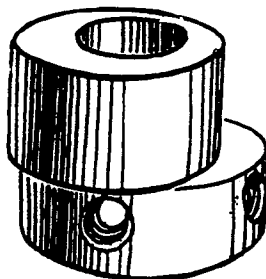

60037

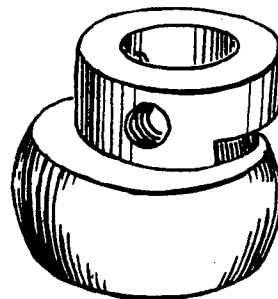

60076

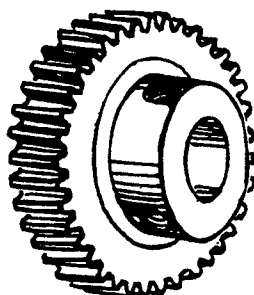

60044

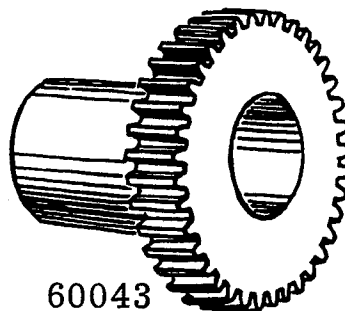

60043



60077 G

Plate 7 - Full Size

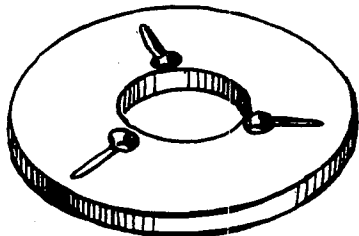

60072 G

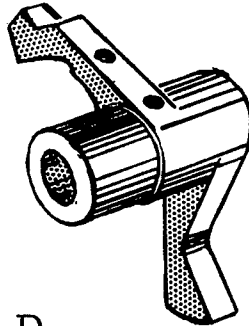

K62210

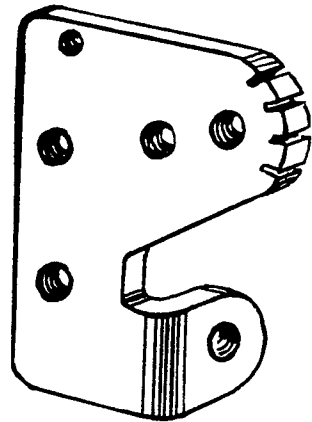

60078 S



22738 D



60078 Z

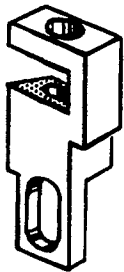

60078 Y

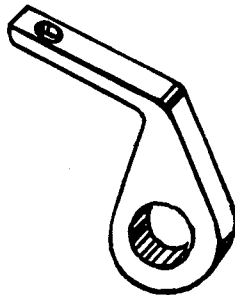

60078 W

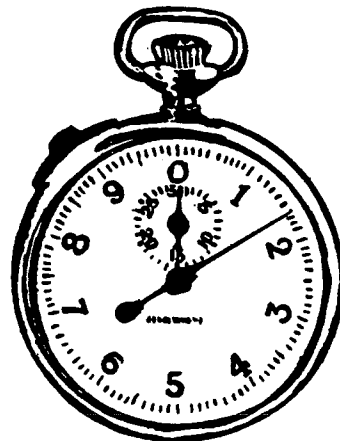

WA 15

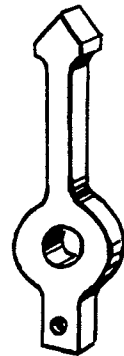

60079 S



60079 K

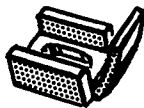

60078 X



41255 B

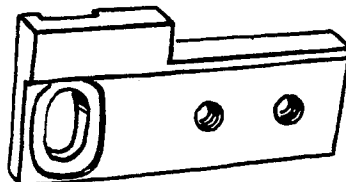

60079 C

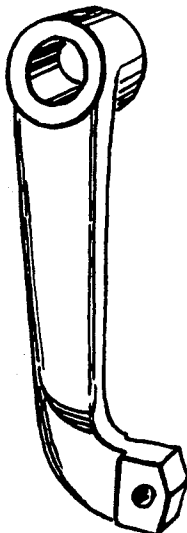

60065

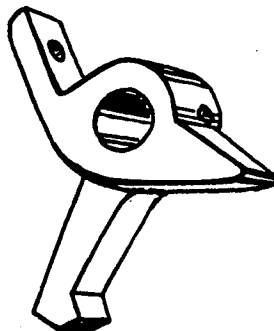

60078 B

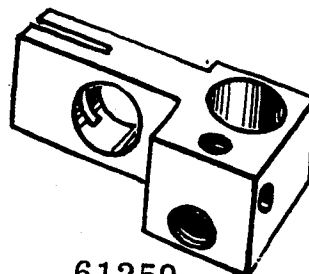

61259



60079 U

Plate 8 - Full Size

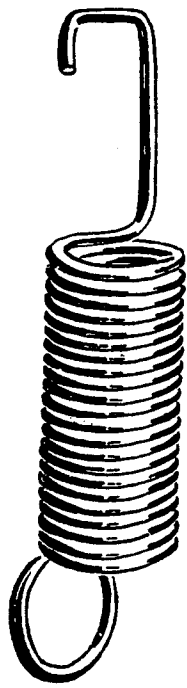

60075 K



60079 H

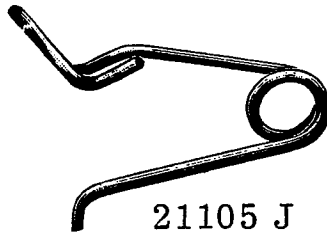

21105 J

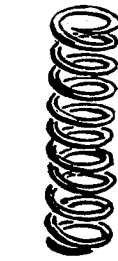

60078 P



1740



60065 G

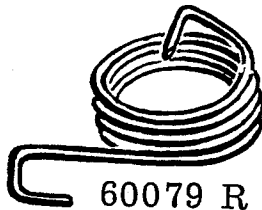

60079 R



51280 J

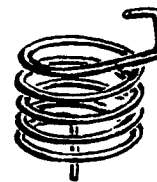

60078 T

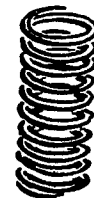

60078 D



51292 F-4



60092 F-14



666-37



21351

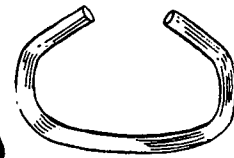

21351 A



60078 V



21718



61282 C



660-142



60093 P



60093 C



60093 T



1346



60078 M

Plate 9 - One-Half Size

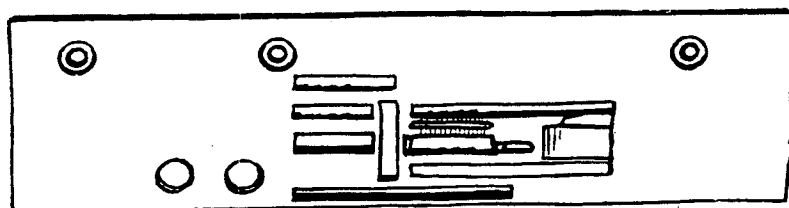

60024 A

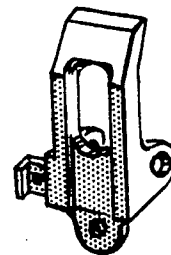

60078 U

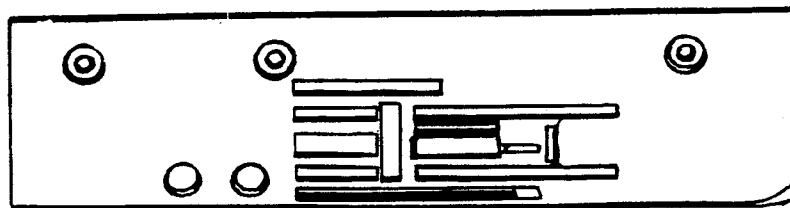

60024 D

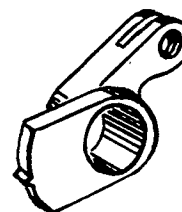

60078 A

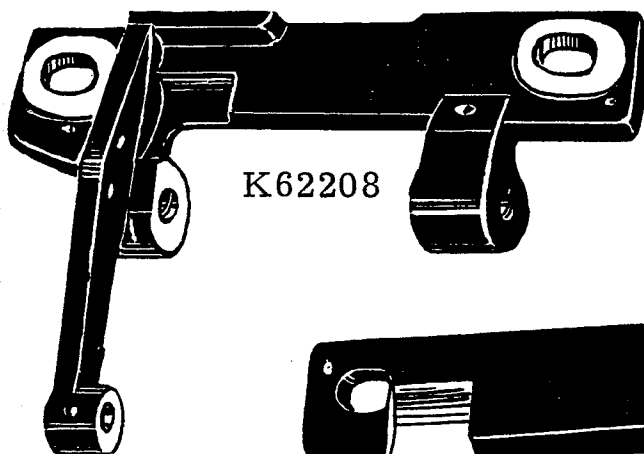

K62208



60079 P

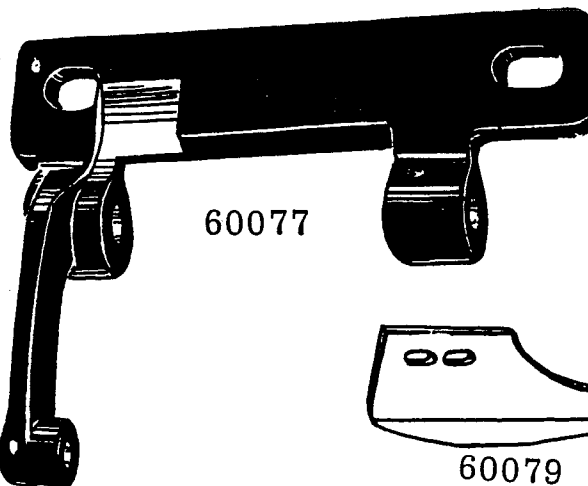

60077

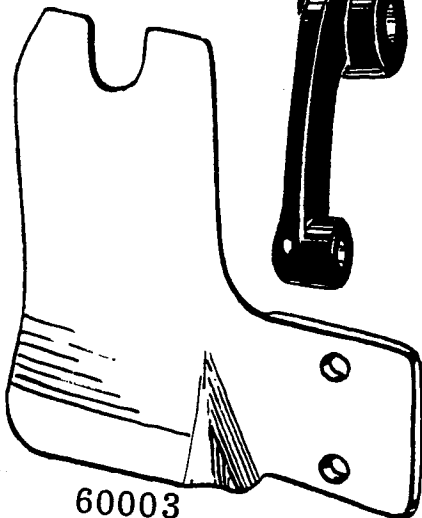

60003



60079



60079 N

Plate 10 - One-Half Size



60079 Q

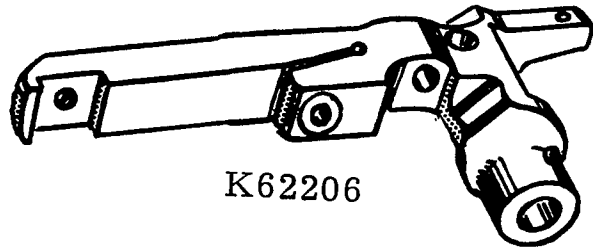

K62206

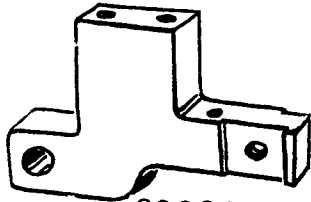

60036 N

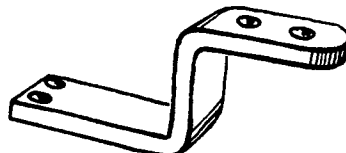

23453 A

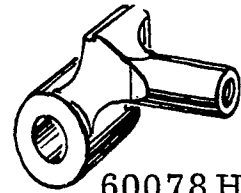

60078 H

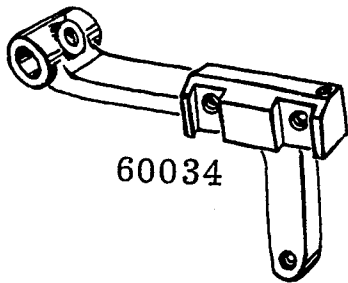

60034

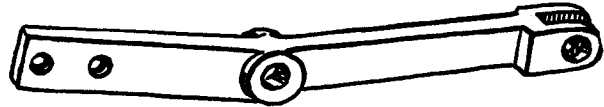

60079 D

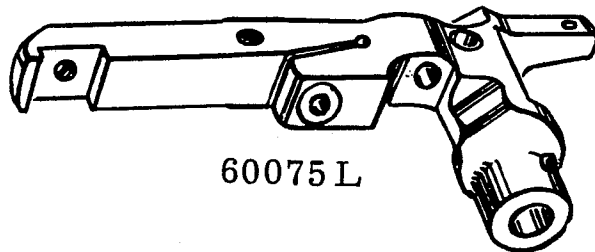

60075 L

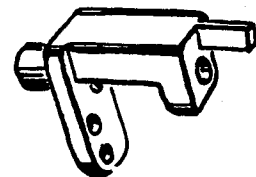

60073 G

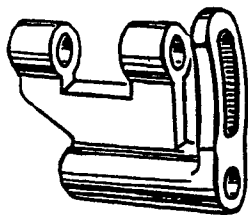

60036



61265

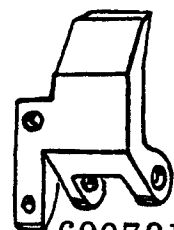

60078 K



Plate 11 - One-Half Size

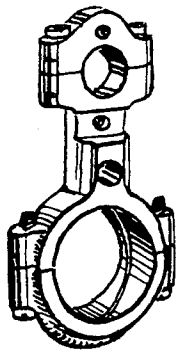

60076 G

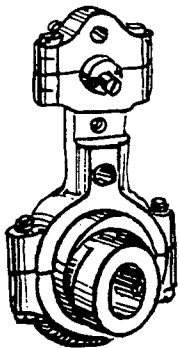

29132 Q

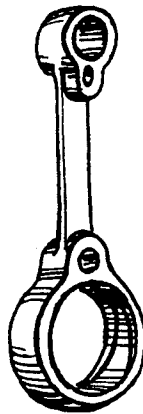

60038

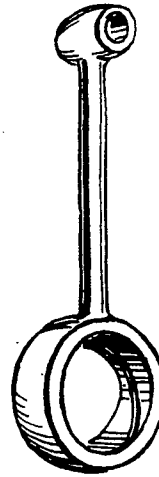

60072

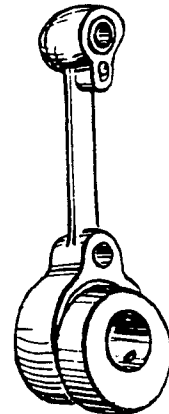

29126 AS

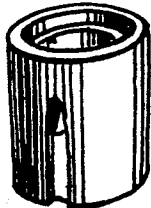

60090

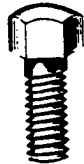

22604

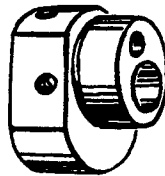

60091 A

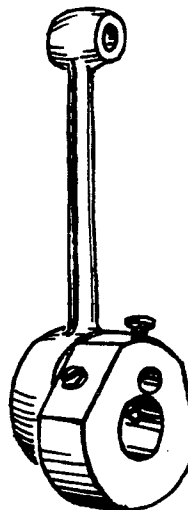

29132 P

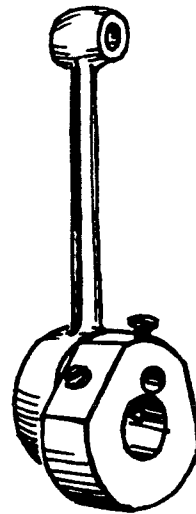

29132 T



61257



50 D



21113 A



60062



60036 G



61356

Plate 12 - One-Half Size

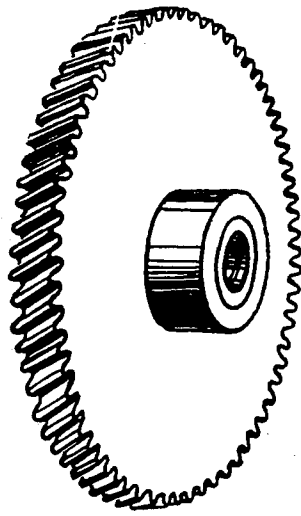

61261

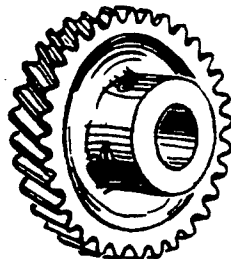

60032 G

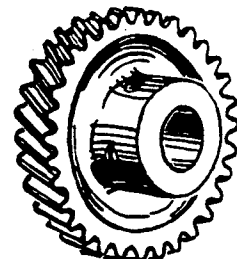

61260

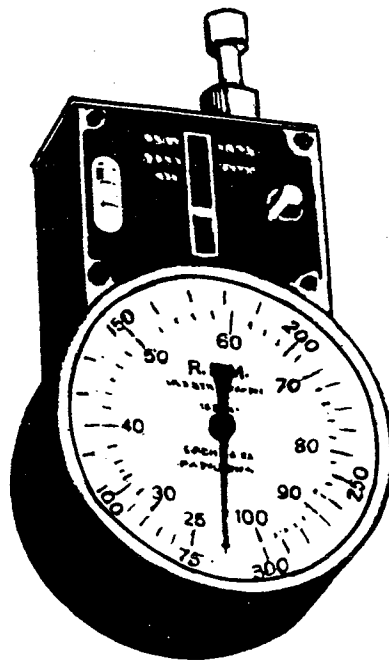

TA 55

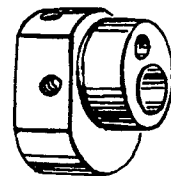

60091

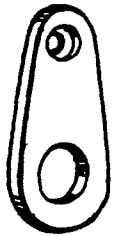

60096

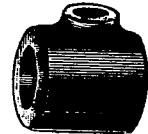

21104 E

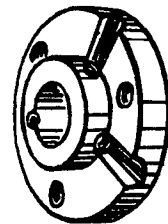

60021 A

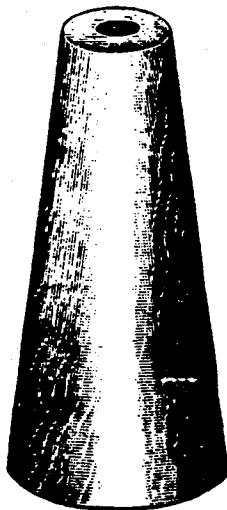

21145



21207



21388 AG



116

Plate 13 - One-Fourth Size

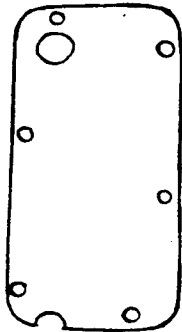

60082 H

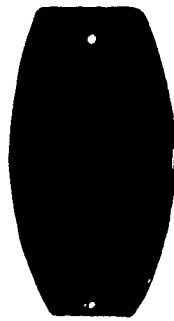

61282 B

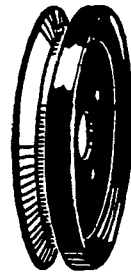

K60901

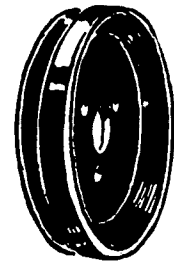

B80621 B

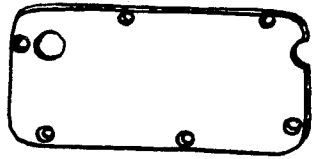

60082 G



21236



23453

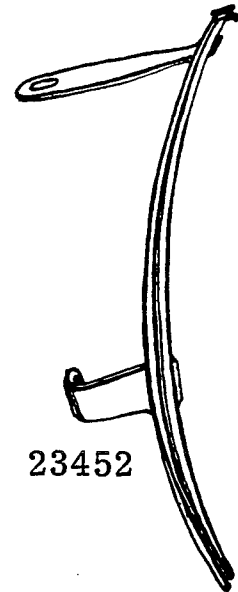

23452



60022



21104 B-11



60032



60040 C

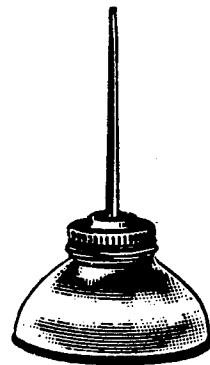

413

Plate 14 - One-Fourth Size, above line  
One-Eight Size, below line

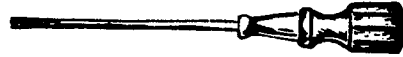

21201

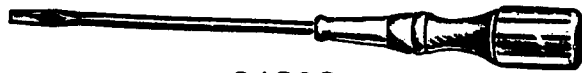

21202



21205 A

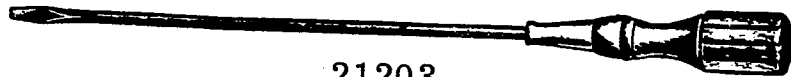

21203

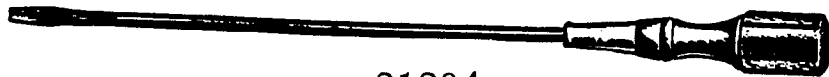

21204



21104K



21104G



21104 F

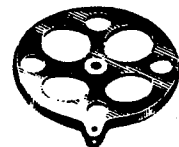

21104D

LIST OF PARTS

Symbol To Order By	The figures in the last column refer only to the plates illustrating the parts and are not to be used in ordering.	Plate No.
WA15	Stop Watch-----	7
20	Washer, for tape cutter upper knife screw on Style 60000 D -----	4
HS24 C	Screw, for tape cutter upper knife pawl extension on Style 60000 D-----	3
25 S	Screw, for tape cutter upper knife actuating lever extension on Style 60000 D-----	3
50 D	Needle Bar -----	11
TA54	Hand Tally-----	--
TA55	Hand Tachometer, 2000 to 8000 R. P. M. -----	12
56	Needle Clamp Nut -----	4
77	Screw, for bag trimming upper knife -----	3
80	Screw, for pulley rim-----	4
81	Set Screw, for tape cutter bracket shaft on Style 60000 C -----	3
82	Adjusting Screw, for tape cutter upper knife bar (lock nut No. 41071 G) -----	3
HS82	Feed Dog Adjusting Screw -----	4
88	Set Screw, for hook shaft collar; also for Nos. 2538, 21113 B, 60040 B, 61242 -----	3
89	Set Screw, for feed bar -----	3
90	Screw, for tape cutter upper knife actuating shoe; also for No. 60078 Y-----	3
91 A	Screw, for upper knife actuating trip dog spring and holder, on Style 60000 D-----	3
93	Screw, for tape cutter upper knife actuating shoe bracket on Style 60000 C; also for No. 23453 A -----	3
93 A	Set Screw, for feed driving shaft collar -----	3
95	Set Screw, for feed drive eccentric; also for Nos. 60076, 61259-----	3
96	Spot Screw, for feed drive eccentric; also for Nos. 60021 A, 60076, 60093 -----	3
96 A	Spot Screw, for hook shaft bushing -----	3
98	Set Screw, for pulley hub-----	3
109	Tension Disc-----	4
116	Wrench, for needle clamp nut-----	12
136	Screw, for feed rocker shaft bracket -----	3
357	Screw, for tape cutter upper knife actuating shoe stop -----	3
376	Screw, for throat plate-----	3
413	Oil Can-----	13
531	Set Screw, for feed driving shaft collar -----	3
605 A	Screw, for auxiliary presser foot arm spring on Style 60000 C-----	3
652-20	Washer, for tape cutter bracket-----	4
660-142	Cotter Pin, for tape cutter upper knife actuating lever stud; also for No. 60079 M on Style 60000 C----	8
666-11	Oil Cup, for intermediate gear shaft-----	2
666-24	Oil Cup, for upper main shaft bearing -----	2
666-37	Felt Wick, for needle bar link -----	8
666-59	Washer, cork, for plug screw -----	4
666-83	Oil Cup, for lower main shaft bearing -----	2

LIST OF PARTS

Symbol To Order By	The figures in the last column refer only to the plates illustrating the parts and are not to be used in ordering.	Plate No.
668-1	Steel Insert, for tension thread eyelet -----	4
668-14	Steel Insert Ferrule, for tension thread eyelet -----	4
719	Screw, for feed rocker shaft -----	3
1066	Collar, for tape cutter upper knife operating pawl pin, on Style 60000 D -----	6
1346	Tension Post -----	8
1740	Tape Cutter Upper Knife Actuating Lever Pin, for Style 60000 D -----	8
2538	Presser Spring Collar (screw No. 88) -----	6
9663	Regulating Screw, for tape cutter upper knife bar on Style 60000 C -----	3
9846	Screw, for tape cutter upper knife operating cam dog on Style 60000 D (nut No. 12934 A) -----	3
9937	Nut, for tape cutter upper knife operating pawl on Style 60000 C -----	4
12538	Nut, for feed lift link screw; also for No. 22517 D -----	4
12934 A	Nut, for upper knife operating cam dog bracket screw on Style 60000 D; also for Nos. 9846, 22560 A, 22799 M -----	4
12935 A	Screw, for adjusting presser foot bottom on Style 60000 D (nut No. 51430 F) -----	3
12957 E	Washer, for tape cutter upper knife screw on Style 60000 C -----	4
21104 B-11	Thread Stand Rod -----	13
21104 D	Thread Stand Spool Seat -----	14
21104 E	Thread Stand Spool Pin Connection -----	12
21104 F	Thread Stand Spool Seat Pad -----	14
21104 G	Thread Stand Spool Pin -----	14
21104 H	Thread Stand Spool Nut -----	4
21104 K	Thread Stand Thread Wire -----	14
21105 J	Thread Stand Thread Guide -----	8
21113 A	Thread Stand Thread Wire Extension -----	11
21113 B	Thread Stand Thread Wire Coupling (screw No. 88) --	5
21145	Cone, wood, for thread stand -----	12
21201	Screwdriver, 9/64 inch round blade, length overall 7 5/8 inches -----	14
21202	Screwdriver, 7/32 inch round blade, length overall 11 1/4 inches -----	14
21203	Screwdriver, 13/64 inch round blade, length overall 15 1/2 inches -----	14
21204	Screwdriver, 9/32 inch round blade, length overall 15 inches -----	14
21205 A	Screwdriver, 3/8 inch round blade, length overall 14 inches -----	14
21207	Screwdriver, 7/64 inch round blade, length overall 2 1/2 inches -----	12
21236	Belt Plier, for 3/8 inch and smaller round belting -----	13
21260	Emery Cord, 3/64 inch diameter, grade No. 120, fifty yard spool -----	--
21260 A	Emery Cord, 3/64 inch diameter, grade No. 50, fifty yard spool -----	--

LIST OF PARTS

Symbol To Order By	The figures in the last column refer only to the plates illustrating the parts and are not to be used in ordering.	Plate No.
21260 B	Emery Cord, 1/32 inch diameter, grade No. 180, fifty yard spool-----	--
21260 C	Emery Cord, .025 inch diameter, grade No. 200, fifty yard spool-----	--
21260 D	Emery Tape, 3/32 inch wide, grade No. 180, fifty yard spool-----	--
21260 E	Emery Cord, .018 inch diameter, grade No. 200, fifty yard spool-----	--
21351	Belt Hook, wire, for 9/32 inch round belt-----	8
21351 A	Belt Hook, wire, for 3/8 inch round belt-----	8
21388 AG	Wrench, offset, for stitch regulating stud-----	12
21394	Utility Grinder, including emery wheel, 5 inches diameter, 1/4 inch face, round belt drive, recommended speed 3000 R. P. M.-----	--
21394 G	Emery Wheel, 5 inches diameter, 1/4 inch face, 3/8 inch hole, grade "M" emery 60-----	--
21394 H	Emery Wheel, 5 inches diameter, 1/2 inch face, 3/8 inch hole, grade "M" emery 60-----	--
21394 K	Utility Grinder, including emery wheel, 5 inches diameter, 1/2 inch face, round belt drive, recommended speed 3000 R. P. M.-----	--
21718	Spring, for tape cutter upper knife pawl lever adjusting block-----	8
22516 A	Screw, for needle bar thread eyelet and holder----	3
22517 B	Screw, for attaching lower tape cutter knife-----	3
22517 D	Screw, for tape cutter upper knife bar on Style 60000 C (nut No. 12538)-----	4
22528	Screw, for upper tape guide; also for Nos. 60005 A, 60026 A, 60036 N, 60064, 60079 C, 60026 D-----	3
22539 C	Plug Screw, for hook shaft hole-----	4
22539 D	Plug Screw, for feed driving shaft hole-----	4
22539 E	Plug Screw, for intermediate gear shaft hole-----	4
22542	Screw, for needle thread take-up eyelet-----	3
22548	Screw, for edge guide-----	3
22559 A	Screw, front, for tape cutter driving eccentric connecting rod-----	3
22559 B	Screw, rear, for tape cutter driving eccentric connecting rod-----	3
22560 A	Screw, for hook shaft driven gear; also for No. 60078 U-----	3
22560 B	Screw, for intermittent needle thread nipper operating plunger sleeve holder-----	3
22562	Set Screw, for hook-----	3
22562 A	Screw, for bag trimming knife bar driving stud; also for No. 61255-----	3
22569	Screw, for bag trimming knife bar bracket-----	3
22570 A	Screw, for feed driving shaft gear case cover; also for Nos. 60091 G, 60096-----	3
22571 A	Plug Screw, for arm of machine-----	3
22588 A	Screw, for lower tape guide-----	3
22595	Screw, for bag trimming knife holder-----	3
22596	Screw, for upper knife operating cam dog bracket on Style 60000 D (nut No. 12934 A)-----	3

LIST OF PARTS

Symbol To Order By	The figures in the last column refer only to the plates illustrating the parts and are not to be used in ordering.	Plate No.
22597	Spot Screw, for main shaft crank and upper bag trimming knife eccentric -----	3
22597 A	Set Screw, for main shaft crank and upper bag trimming knife eccentric; also for No. 60062 -----	3
22604	Screw, for tape cutter bracket -----	11
22617 P-48	Plug Screw, for plugging hole in bottom of frame ---	4
22738 A	Stop Screw, for upper knife cam dog spring -----	3
22738 D	Screw for K62210 -----	7
22747	Screw, for tape cutter driving eccentric connecting rod ball stud fork -----	3
22764	Spot Screw, for hook shaft coupling -----	3
22775	Screw, for supporting lower knife; also for Nos. 60020 A, 60020 D -----	3
22795	Adjusting Screw, for tape cutter upper knife actuating shoe support on Style 60000 C -----	3
22799 D	Stop Screw, upper, for tape cutter upper knife operating cam dog -----	4
22799 H	Hinge Screw, for auxiliary presser foot on Style 60000 C; also for Nos. 60020 D, 60079 S -----	4
22799 M	Screw, for hand lifter; also stop screw, lower, for tape cutter upper knife operating cam dog on Style 60000 D -----	3
22812	Screw, for tape cutter upper knife actuating trip dog (nut No. 43443 Q) -----	3
22837	Screw, for face plate -----	4
22839	Screw, for tape cutter bracket shaft on Style 60000 D -----	3
22839 B	Set Screw, for feed driving shaft gear -----	3
22839 C	Set Screw, for main shaft gear; also for No. 60032 G -----	3
22845 D	Screw, for feed lift link (nut No. 12538) -----	4
22874	Adjusting Screw, for tape cutter upper knife operating pawl, on Style 60000 C (nut No. 9937) ---	3
22881	Screw, for feed eccentric connecting rod bearing sleeve (nut No. 60038 N, washer No. 60038 K) ----	3
22882	Screw, for tape cutter upper knife (washer No. 12957 E on Style 60000 C, No. 20 on Style 60000 D) -----	3
23452	Upper Tape Guide (screw No. 22528) -----	13
23453	Lower Tape Guide (screw No. 22588 A) -----	13
23453 A	Lower Tape Guide Bracket (screw No. 93) -----	10
29126 AS	Feed Driving Eccentric Assembly; one each Nos. 60037, 60038, 60038 G, lapped together -----	11
29132 P	Main Shaft Crank and Upper Bag Trimming Knife Eccentric Assembly, on Style 60000 C; one each Nos. 60072, 60091, lapped together -----	11
29132 Q	Tape Cutter Upper Knife Driving Eccentric Assembly; one each Nos. 39144 N, 60076, 60076 G, lapped together -----	11
29132 T	Main Shaft Crank and Upper Bag Trimming Knife Eccentric Assembly, on Style 60000 D; one each Nos. K61096, 60072, lapped together -----	11
33174 B	Screw, for tape cutter upper knife lever actuating stud -----	3



LIST OF PARTS

Symbol To Order By	The figures in the last column refer only to the plates illustrating the parts and are not to be used in ordering.	Plate No.
35772 H	Washer, for tape cutter upper knife actuating shoe bracket on Style 60000 C; also for No. 60079 C-----	4
39544 H	Tape Cutter Driving Eccentric Connecting Rod Ball Stud-----	6
41071 G	Lock Nut, for tape cutter upper knife bar adjusting screw-----	4
41255 B	Tape Cutter Driving Eccentric Connecting Rod Ball Stud Fork (screw No. 22747)-----	7
43443 Q	Nut, for tape cutter upper knife actuating trip dog screw-----	4
51192 G	Tension Thread Eyelet (steel insert No. 668-1, insert ferrule No. 668-14)-----	4
51280 J	Feed Rocker Shaft Bracket Dowel Pin-----	8
51292 A	Tension Post Ferrule-----	4
51292 B	Tension Spring Ferrule-----	4
51292 C	Tension Regulating Nut-----	4
51292 F-4	Tension Spring, .031 inch diameter wire-----	8
51430 F	Nut, for presser foot bottom adjusting screw on Style 60000 D-----	4
60003	Edge Guide, for top of bag (screw No. 22548)-----	9
60005 A	Feed Dog (screw No. 22528)-----	1
60008 A	Thread Hook (screw No. 22562)-----	2
60020 A	Presser Foot Assembly, on Style 60000 C; one each Nos. 60030, 60030 A, 61330 B-35 (screw No. 22775)-----	1
60020 D	Presser Foot Assembly, on Style 60000 D; one each Nos. 12935 A, 22799 H, 51430 F, 60030 B, 60030 C (screw No. 22775)-----	1
60021 A	Pulley Hub (spot screw No. 96, set screw No. 98)-----	12
60022	Main Shaft-----	13
60024 A	Throat Plate, for Style 60000 C (screw No. 376)---	9
60024 D	Throat Plate, on Style 60000 D (screw No. 376)---	9
60026 A	Auxiliary Feed Dog, on Style 60000 C (screw No. 22528)-----	1
60026 D	Auxiliary Feed Dog, on Style 60000 D (screw No. 22528)-----	1
60027 A	Auxiliary Presser Foot, on Style 60000 C (hinge screw No. 22799 H)-----	1
60030	Presser Foot Shank, on Style 60000 C (screw No. 22775)-----	1
60030 A	Presser Foot Bottom, on Style 60000 C (hinge pin No. 61330 B-35)-----	1
60030 B	Presser Foot Shank, on Style 60000 D-----	2
60030 C	Presser Foot Bottom, on Style 60000 D (adjusting screw No. 12935 A, hinge screw No. 22799 H)----	1
60032	Feed Driving Shaft-----	13
60032 C	Feed Driving Shaft Collar (set screw, headless, No. 531, set screw, fillister head, No. 93 A)-----	5
60032 G	Feed Driving Shaft Gear (set screw, fillister head, 7/32 inch long, No. 22839 B, set screw, fillister head, 5/16 inch long, No. 22839 C)-----	12

LIST OF PARTS

Symbol To Order By	The figures in the last column refer only to the plates illustrating the parts and are not to be used in ordering.	Plate No.
60032 N	Feed Driving Shaft Bushing, lower -----	5
60032 U	Feed Driving Shaft Bushing, middle -----	6
60032 W	Feed Driving Shaft Bushing, upper -----	5
60034	Feed Bar (set screw No. 89) -----	10
60035	Feed Bar Shaft -----	6
60036	Feed Rocker -----	10
60036 G	Feed Rocker Shaft (set screw No. 719) -----	11
60036 N	Feed Rocker Shaft Bracket (screw, upper, No. 22528, screw, lower, No. 136, washer No. 80557) -----	10
60036 U	Feed Rocker Shaft Bushing, upper -----	5
60036 W	Feed Rocker Shaft Bushing, lower -----	6
60037	Feed Drive Eccentric (spot screw No. 96, set screw No. 95) -----	6
60038	Feed Drive Eccentric Connecting Rod -----	11
60038 G	Feed Drive Eccentric Connecting Rod Bearing Sleeve (screw No. 22881) -----	6
60038 K	Feed Drive Eccentric Connecting Rod Bearing Sleeve Thrust Washer -----	4
60038 N	Feed Drive Eccentric Connecting Rod Bearing Sleeve Screw Nut -----	4
60040 A	Hook Shaft, upper section -----	2
60040 B	Hook Shaft Coupling (spot screw No. 22764, set screw No. 88) -----	5
60040 C	Hook Shaft, lower section -----	13
60041	Hook Shaft Bushing, lower (screw No. 96 A) -----	5
60041 A	Hook Shaft Bushing, upper -----	5
60042	Hook Shaft Collar (screw No. 88) -----	6
60043	Hook Shaft Driving Gear -----	6
60044	Hook Shaft Driven Gear (screw No. 22560 A) -----	6
60051	Needle Thread Take-up Eyelet (screw No. 22542) ---	4
60058	Needle Bar Thread Eyelet, on Style 60000 C (screw No. 22516 A) -----	4
60058 A	Needle Bar Thread Eyelet, on Style 60000 D (screw No. 22516 A) -----	4
60058 G	Needle Bar Thread Eyelet Holder (screw No. 22516 A) -----	6
60062	Intermediate Gear Shaft (screw No. 22597 A, oil cup No. 666-11) -----	11
60064	Intermediate Gear Shaft Collar (screw No. 22528) -----	5
60065	Auxiliary Presser Foot Arm, on Style 60000 C -----	7
60065 G	Auxiliary Presser Foot Arm Spring, on Style 60000 C (screw No. 605 A) -----	8
60070	Bag Trimming Knife, upper (screw No. 77) -----	2
60071	Bag Trimming Knife Holder (screw No. 22595) -----	1
60072	Bag Trimming Knife Eccentric Connecting Rod -----	11
60072 G	Bag Trimming Knife Eccentric Connecting Rod Thrust Washer -----	7
60073	Bag Trimming Knife Bar -----	2
60073 G	Bag Trimming Knife Bar Bracket (screw No. 22569) -----	10

LIST OF PARTS

Symbol To Order By	The figures in the last column refer only to the plates illustrating the parts and are not to be used in ordering.	Plate No.
60073 N	Bag Trimming Knife Bar Driving Stud (screw No. 22562 A) -----	2
60075	Tape Cutter Knife, upper, on Style 60000 C (screw No. 22882, washer No. 12957 E) -----	2
60075 G	Tape Cutter Knife, lower (attaching screw No. 22517 B, supporting screw No. 22775) -----	2
60075 K	Tape Cutter Upper Knife Bar Spring (support pin No. 61267 G) -----	8
60075 L	Tape Cutter Upper Knife Bar, on Style 60000 C (adjusting screw No. 82, regulating screw No. 9663, adjusting screw lock nut No. 41071 G, stop screw No. 22517 D, stop screw lock nut No. 12538) -----	10
60076	Tape Cutter Driving Eccentric (spot screw No. 96, set screw No. 95) -----	6
60076 G	Tape Cutter Driving Eccentric Connecting Rod (screw, front, No. 22559 A, screw, rear, No. 22559 B) -----	11
60077	Tape Cutter Bracket, on Style 60000 C (screw No. 22604, washer No. 652-20, dowel pin No. 60077 K)-----	9
60077 G	Tape Cutter Bracket Shaft, on Style 60000 C (set screw No. 81) -----	6
60077 H	Tape Cutter Bracket Shaft, on Style 60000 D (set screw No. 22839)-----	6
60077 J	Spacing Collar, for tape cutter upper knife bar on Style 60000 D -----	6
60077 K	Dowel Pin, for tape cutter bracket -----	6
60078 A	Tape Cutter Upper Knife Operating Cam, on Style 60000 C -----	9
60078 B	Tape Cutter Upper Knife Operating Cam Dog, on Style 60000 C -----	7
60078 D	Tape Cutter Upper Knife Operating Cam Dog Spring, on Style 60000 C -----	8
60078 E	Tape Cutter Upper Knife Operating Cam Bushing, on Style 60000 C -----	5
60078 H	Tape Cutter Upper Knife Operating Ratchet Lever --	10
60078 K	Tape Cutter Upper Knife Operating Pawl, on Style 60000 C (adjusting screw No. 22874, adjusting screw nut No. 9937) -----	10
60078 M	Tape Cutter Upper Knife Operating Pawl Pin (cotter pin No. 660-142 on Style 60000 C, collar No. 1066 on Style 60000 D)-----	8
60078 P	Tape Cutter Upper Knife Operating Pawl Spring, on Style 60000 C -----	8
60078 S	Tape Cutter Upper Knife Operating Cam Dog Bracket, on Style 60000 D (attaching and adjusting screw No. 22596, nut No. 12934 A)-----	7
60078 T	Tape Cutter Upper Knife Cam Dog Spring, on Style 60000 D (stop screw No. 22738 A)-----	8
60078 U	Tape Cutter Upper Knife Operating Driving Pawl, on Style 60000 D (screw No. 22560 A, nut No. 12934 A) -----	9

LIST OF PARTS

Symbol To Order By	The figures in the last column refer only to the plates illustrating the parts and are not to be used in ordering.	Plate No.
60078 V	Tape Cutter Upper Knife Pawl Operating Spring, on Style 60000 D-----	8
60078 W	Tape Cutter Upper Knife Pawl Lever, on Style 60000 D-----	7
60078 X	Tape Cutter Upper Knife Pawl Lever Extension, on Style 60000 D (screw No. HS24 C)-----	7
60078 Y	Tape Cutter Upper Knife Pawl Lever Adjusting Block, on Style 60000 D (screw No. 90, spring No. 21718)-----	7
60078 Z	Nut for 22738 D-----	7
60079	Tape Cutter Upper Knife Actuating Shoe, on Style 60000 C (screw No. 90)-----	9
60079 A	Tape Cutter Upper Knife Actuating Shoe Stop, on Style 60000 C (screw No. 357)-----	2
60079 B	Tape Cutter Upper Knife Actuating Shoe Bracket, on Style 60000 C (screw No. 93, washer No. 35772 H)-----	2
60079 C	Tape Cutter Upper Knife Actuating Shoe Support, on Style 60000 C (attaching screw No. 22528, adjusting screw No. 22795)-----	7
60079 D	Tape Cutter Upper Knife Actuating Lever, on Style 60000 C-----	10
60079 F	Tape Cutter Upper Knife Actuating Lever Stud-----	5
60079 H	Tape Cutter Upper Knife Actuating Lever Spring, on Style 60000 C-----	8
60079 K	Tape Cutter Upper Knife Actuating Lever Link, on Style 60000 C-----	7
60079 M	Tape Cutter Upper Knife Actuating Lever Link Pin, on Style 60000 C (cotter pin No. 660-142)----	6
60079 N	Tape Cutter Upper Knife Actuating Shoe, on Style 60000 D (screw No. 90)-----	9
60079 P	Tape Cutter Upper Knife Actuating Lever, on Style 60000 D (pin No. 1740)-----	9
60079 Q	Tape Cutter Upper Knife Actuating Lever Extension, on Style 60000 D (screw No. 25 S)-----	10
60079 R	Tape Cutter Upper Knife Actuating Lever Spring, on Style 60000 D-----	8
60079 S	Tape Cutter Upper Knife Actuating Trip Dog, on Style 60000 D (screws Nos. 22799 H, 22812, nut No. 43443 Q)-----	7
60079 U	Upper Knife Actuating Trip Dog Spring and Holder, complete, on Style 60000 D (spring attaching screw No. 91 A)-----	7
60082 G	Feed Driving Shaft Gear Case Cover (screw No. 22570 A)-----	13
60082 H	Feed Driving Shaft Gear Case Cover Gasket-----	13
‡60090	Main Shaft Bushing Housing-----	11
60090 G	Main Shaft Bushing, lower-----	5
60090 H	Main Shaft Bushing, upper-----	5
60091	Main Shaft Crank and Upper Bag Trimming Knife Eccentric, on Style 60000 C (spot screw No. 22597, set screw No. 22597 A, crank pin screw No. 22570 A)-----	12
60091 G	Main Shaft Crank Pin (screw No. 22570 A)-----	5

‡ See page 5

LIST OF PARTS

Symbol To Order By	The figures in the last column refer only to the plates illustrating the parts and are not to be used in ordering.	Plate No.
60092 F-14	Needle Thread Tension Spring, .047 inch diameter wire -----	8
60093	Intermediate Needle Thread Nipper Eccentric (spot screw No. 96) -----	5
60093 C	Intermittent Needle Thread Nipper Operating Plunger -----	8
60093 G	Intermittent Needle Thread Nipper Operating Plunger Sleeve -----	5
60093 K	Intermittent Needle Thread Nipper Operating Plunger Sleeve Holder (screw No. 22560 B) -----	5
60093 P	Intermittent Needle Thread Nipper Releasing Pin ---	8
60093 T	Intermittent Needle Thread Nipper Tension Post ---	8
60096	Bed Mounting Shim (screw No. 22570 A) -----	12
K60901	Pulley Rim, working diameter 4 1/4 inches, grooved for No. 2 "V" belt (screw No. 80) -----	13
K61096	Main Shaft Crank and Upper Bag Trimming Knife Eccentric on Style 60000 D (spot screw No. 22597, set screw No. 22597 A, crank pin screw No. 22570 A) REPLACED BY No. 60091 A -----	11
61233 N	Feed Lift Link (screw No. 22845 D, nut No. 12538) -----	2
61242	Collar, for tape cutter upper knife actuating lever stud (screw No. 88) -----	6
61254	Needle Bar Bushing, front -----	5
61254 A	Needle Bar Bushing, rear -----	6
61255	Needle Bar Connection (screw No. 22562 A) -----	2
61255 G	Needle Bar Link (felt wick No. 666-37) -----	2
61256 G	Presser Spring Washer -----	4
61257	Presser Bar -----	11
61257 G	Presser Bar Bushing, front, and Presser Spring Regulator -----	5
61259	Presser Bar Connection (set screw No. 95) -----	7
61260	Main Shaft Gear (screw No. 22839 C) -----	12
61261	Feed Driving Shaft Intermediate Gear -----	12
61263	Feed Driving Shaft Intermediate Gear Bushing -----	5
61265	Hand Lifter (screw No. 22799 M) -----	10
61267 G	Tape Cutter Upper Knife Bar Spring Pin -----	6
61282 B	Face Plate (screw No. 22837) -----	13
61282 C	Face Plate Pin -----	8
61292 H	Tension Release Washer -----	4
61293 N	Plug, .814 inch diameter, for lower section of arm -----	5
61330 B-35	Hinge Pin, for presser foot bottom on Style 60000 C -----	6
61356	Presser Spring -----	11
K62206	Tape Cutter Upper Knife Bar, on Style 60000 D (adjusting screw, No. 82, regulating screw, No. 9663, adjusting screw lock nut, No. 41071 G) REPLACED BY No. 60075 L -----	10
K62208	Tape Cutter Bracket, on Style 60000 D (screw No. 22604, washer No. 652-20, dowel pin No. 60077 K) REPLACED BY No. 60077 -----	9

LIST OF PARTS

Symbol To Order By	The figures in the last column refer only to the plates illustrating the parts and are not to be used in ordering.	Plate No.
K62210	Tape Cutter Upper Knife Operating Cam Dog, on Style 60000 D (screw No. 9846, nut No. 12934 A, stop screw, upper, No. 22799 D, stop screw, lower, No. 22799 M) REPLACED BY No. 60078 Q, 60078 R -----	7
K62216	Tape Cutter Upper Knife, on Style 60000 D (screw No. 22882, washer No. 20) REPLACED BY No. 60075-----	2
80557	Washer, for feed rocker shaft bracket -----	4
B80621 B	Pulley Rim, working diameter 4 1/4 inches, grooved for round belt (screw No. 80) -----	13

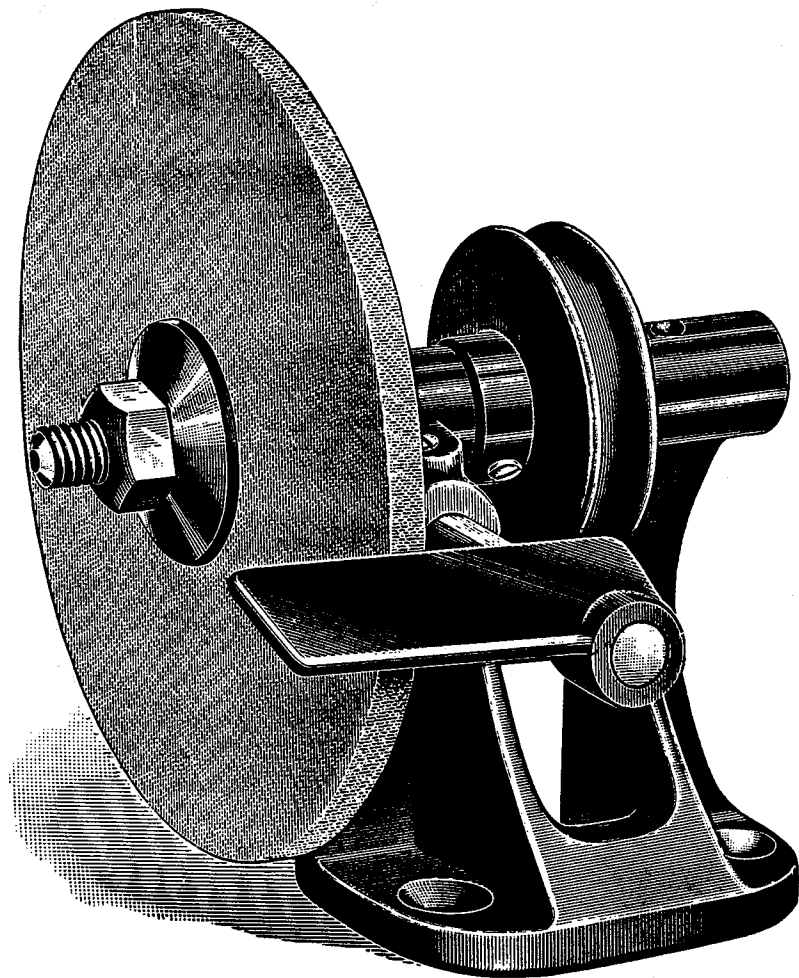

21394

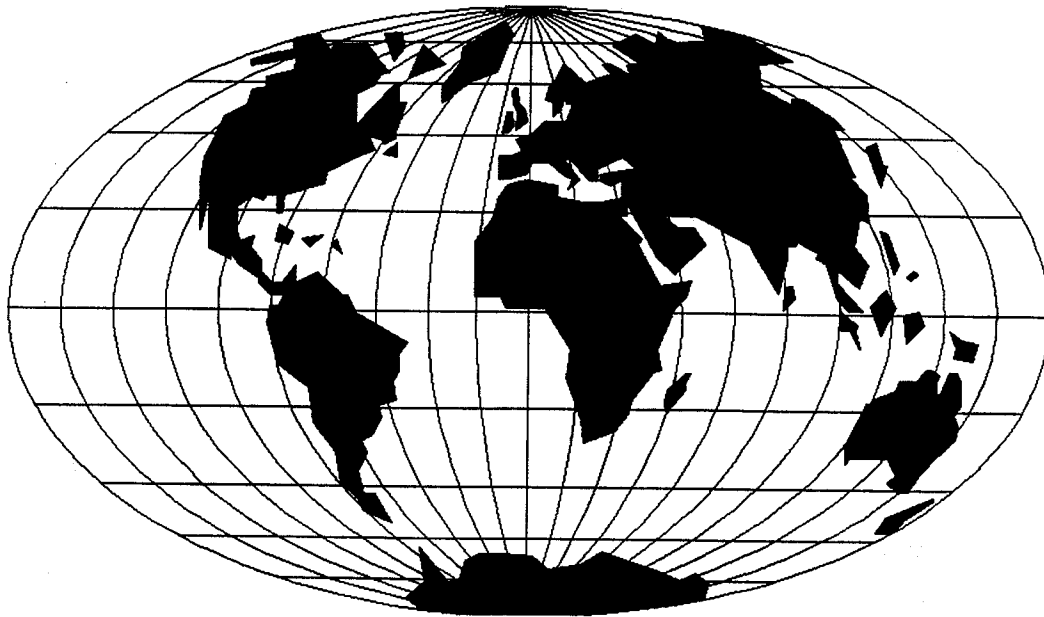

## WORLDWIDE SALES AND SERVICE

Union Special Corporation maintains sales and service facilities throughout the world. These offices will aid you in the selection of the right sewing equipment for your particular operation. Union Special Corporation representatives and service technicians are factory trained and are able to serve your needs promptly and efficiently. Whatever your location, there is a qualified representative to serve you.

---

**Corporate Office:** One Union Special Plaza  
Huntley, IL 60142  
Phone: 708•669•5101  
Fax: 708•669•1096

**European Distribution Center:** Union Special GmbH  
Ralf Feisenstrasse 3  
D-71696 Möglingen, Germany  
Tel: 49•07141•247•0  
Fax: 49•7141•247•100

Brussels, Belgium  
Charlotte, N.C.  
Commerce, CA  
El Paso, TX  
Hong Kong, China  
Huntley, IL  
Leicester, England  
Lille, France  
Miami, FL  
Milan, Italy  
Mission, TX  
Möglingen, Germany  
Montreal, Quebec  
Osaka, Japan

Other Representatives throughout  
all parts of the world.



*Union Special*  
INDUSTRIAL SEWING EQUIPMENT